



ALLIED MACHINE & ENGINEERING

Holemaking Solutions for Today's Manufacturing



Master Product CATALOG



Drilling



Boring



Reaming



Burnishing



Threading



Specials

www.alliedmachine.com

It's so much easier when you make
BETTER CHIPS

Allied Machine specializes in developing innovative solutions designed to *pulverize* material. Our tools achieve the chip formation and chip evacuation you need to increase your production.



Allied Machine & Engineering
Registered to ISO 9001
10001329



Our Commitment to YOU



Manufacturing is the DNA of success everywhere in the world. When you're manufacturing, you're building, creating, and developing something that physically didn't exist before.

At Allied Machine, our core purpose is to provide practical and dependable solutions to improve your manufacturing processes. We know you face challenges and difficulties every day, so we're here to simplify your holmaking processes and improve your production.

However, many factors must be incorporated to truly improve production.

Some of those factors include increasing penetration rates while also improving chip formation and evacuation, reducing scrap rates by producing better parts, reducing set-up times, and increasing tool life to get the most from your investment.

Not only does our tooling achieve these results, but our customer service is also an extension of our tooling advantages. Our Application Engineers and Field Sales Engineers are available to assist with any problems you encounter. Don't hesitate to put their skills and knowledge to the test. They won't disappoint.

This is our commitment to manufacturing, and it's our promise to you.



North America

Allied Machine
120 Deeds Drive
Dover, OH 44622
United States

Allied Machine
485 West 3rd Street
Dover, OH 44622
United States

ThreadMills USA™
4185 Crosstowne Ct #B
Evans, GA 30809
United States

Superion™
1285 S Patton St.
Xenia, OH 45385
United States

Europe

Allied Machine Europe
93 Vantage Point
Pensnett Estate
Kingswinford
West Midlands
DY6 7FR, United Kingdom

Wohlhaupter® GmbH
Maybachstrasse 4
Postfach 1264
72636 Frickenhausen
Germany

Asia

Wohlhaupter® India
B-23, 2nd Floor
B Block Community Centre
Janakpuri, New Delhi - 110058
India



Allied Machine & Engineering is a worldwide leader in holemaking and finishing solutions. We are committed to providing practical and dependable solutions to our customers through innovative designs and superior customer and technical support.

We continue to expand our product offering in order to provide new and different solutions. With Field Sales Engineers located around the world, we position ourselves to provide technical support on site, right at your spindle.



www.alliedmachine.com

The background features a light gray dot grid pattern overlaid with several thin, light gray geometric lines. These lines form concentric arcs and intersecting straight lines, creating a technical or architectural feel. The overall composition is clean and modern.

Master Product

CATALOG

Flipbooks and Digital PDF Downloads

Every Section Available Online

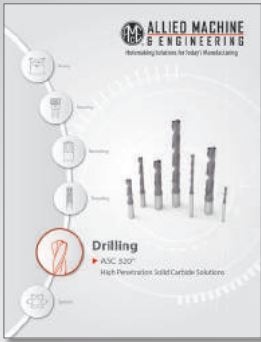

Section A10
ASC 320®



Section A20 (*AMPC-A2)
GEN3SYS® XT and XT Pro



Section A30
Original T-A® and GEN2 T-A®



Section A40 (*AMPC-A4)
High Performance / Universal



Section A50
APX Drill



Section A60
Revolution Drill®



Section A70
Opening Drill®



Section A91
Structural Steel Solutions



Section A92
AccuPort 432®



Section A93
BT-A Drill



Section B10 (*WOHLCAT)
Wohlhaupter® Boring Systems



Section B20 (*AMPC-B2)
Criterion™ Modular Boring



Section C
Reaming



Section D (*AMPC-D)
Burnishing



Section E
Threading



Section X
Special Tooling Solutions

*Also available in print

View, download, and share individual product line sections at
www.alliedmachine.com/Literature



Find what you're looking for. Now.

Flipbook gives you the ability to search for a specific item number and find the page(s) where it's located. Save time searching the catalog by hand if you already know what item number you need. Visit the Flipbooks now.

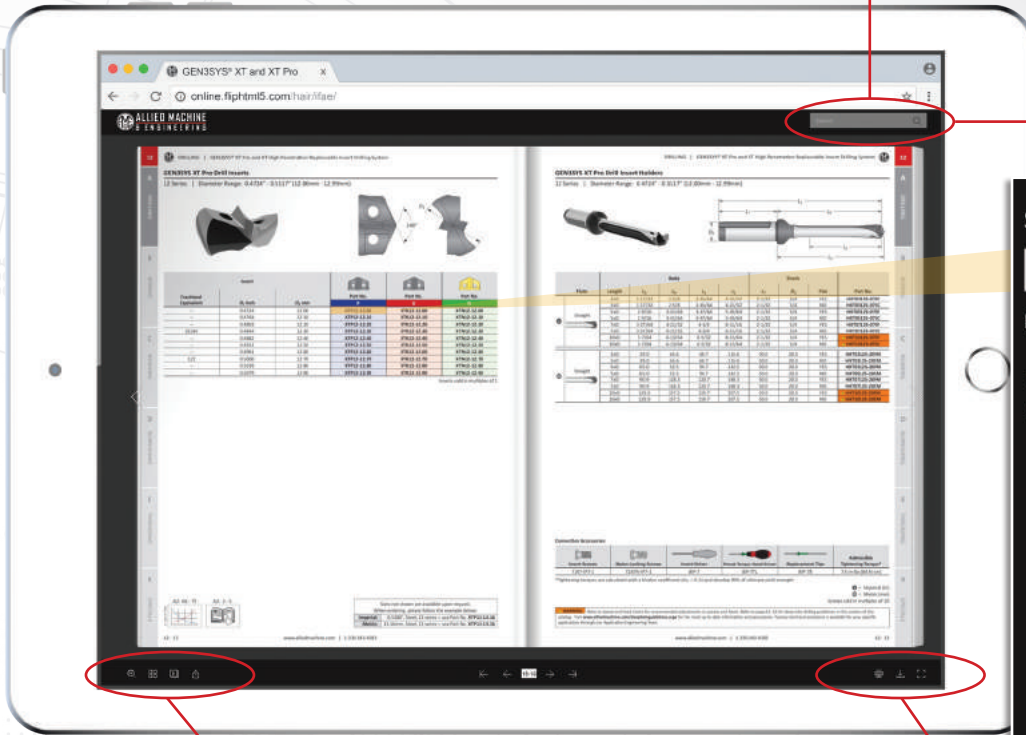

Zoom in for a closer look

Set the catalog to auto flip

Scroll through the pages in thumbnail view

Share the Flipbook with others



Print the full catalog or specific pages

View in full screen mode

Download the catalog PDF

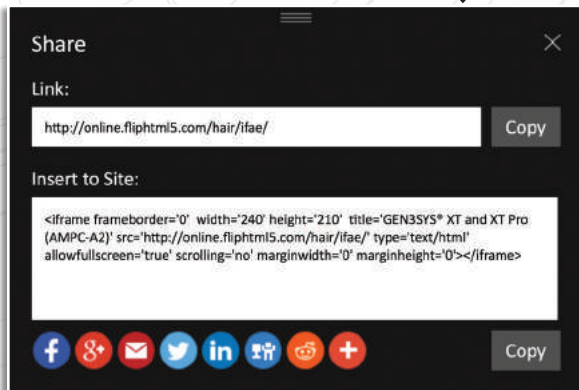

Share the link to each Flipbook via email and social media

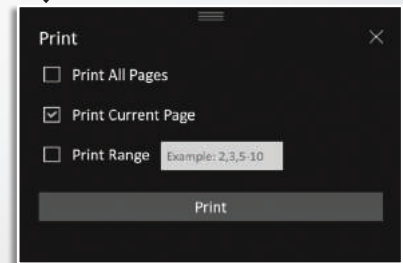

The Foundation

Since 1941, Allied Machine & Engineering has provided dependable and practical holmaking solutions to the world. What was once a small job shop in Ohio is now a worldwide leader in cutting tool technology. With three manufacturing facilities in Ohio, one in Georgia, another in Germany, and headquarters in both the United States and Europe, Allied Machine is positioned to bring innovative solutions and technical expertise directly to the customers' hands.



The Beginning

Harold E. Stokey founded Allied Machine & Engineering to aid the war effort, manufacturing taper bearing lock nuts for the production of M1 tanks. Years later, after a sales meeting gone wrong, Stokey possessed a warehouse stocked with spade drill inserts. He set forth into the industry that would become Allied Machine's thriving identity: holmaking.



The T-A®

When Harold's son, William H. Stokey, became the president and CEO, he developed the Throw Away, or T-A, spade drill insert system. The T-A revolutionized the holmaking industry, launching Allied Machine ahead of the competition. Since then, numerous innovations and advancements have been created from the T-A's inspiration.



The Innovation

Since the development of the T-A, Allied Machine has expanded its product offering to support a vast range of customer applications, including large diameter and deep hole drilling, boring, reaming, burnishing, porting, and threading.

The People

Allied Machine understands that high quality products are only one facet of success. Our customer support is crucial to what we do, and that's why we make sure the best engineers and customer service associates are in place to assist our customers around the world.

The Future

With over 75 years of experience, Allied Machine has encountered the challenges of growth and success. By investing in cutting edge technology and the brightest and sharpest minds, our knowledge and capabilities continue to expand and grow every day.



Steve Stokey
Executive Vice President

William H. Stokey
President and CEO

Mike Stokey
Executive Vice President



**ALLIED MACHINE
& ENGINEERING**

Holmaking Solutions for Today's Manufacturing

WOHLHAUPTER®



SUPERION™

CRITERION™

Contents

Introduction

Product Offering Overview	ii - v
Customer Support and Training Information	vi - vii
Navigating the Catalog	x - xi
Drilling Product Selection Guide	xii - xiii

A10	ASC 320® Solid Carbide Drilling Solutions	A10: 1 - 15
A20	GEN3SYS® XT and XT Pro High Penetration Replaceable Insert Drilling System	A20: 1 - 87
A30	T-A® Drilling System Replaceable Insert Drilling System	A30: 1 - 147
A40	High Performance / Universal Replaceable Insert Drilling System	A40: 1 - 49
A50	APX Drill Large Diameter / Deep Hole Drilling System	A50: 1 - 31
A60	Revolution Drill® Large Diameter Drilling System	A60: 1 - 23
A70	Opening Drill® Large Diameter Drilling System	A70: 1 - 17
A91	Structural Steel Solutions GEN3SYS® XT and T-A® Replaceable Insert Drilling Systems	A91: 1 - 39
A92	AccuPort 432® Hydraulic Porting Solutions	A92: 1 - 37
A93	BT-A Drill BTA (STS) Machining Solutions	A93: 1 - 7
B20	Criterion™ Modular Boring Systems	B20: 1 - 87
C	Reaming ALVAN® Reaming Systems by S.C.A.M.I.®	C: 1 - 81
D	Burnishing Roller Burnishing Systems by S.C.A.M.I.®	D: 1 - 45
E	Threading Solid Carbide and Indexable Thread Milling Solutions	E: 1 - 57
X	Specials Special Tooling Solutions	X: 1 - 26
	Index	INDEX: 1 - 5

Visit www.alliedmachine.com/Literature to access the Wohlhaupter® product catalogs.

For Guaranteed Test/Demo Application, see the last page of this book.

Product Offering Overview

Replaceable Insert Drills

- Reduce costs by decreasing set-up time and utilizing a single holder for the lives of multiple inserts
- Provide flexibility to quickly switch between inserts with different geometries
- Products:
 - GEN3SYS® XT | GEN3SYS® XT Pro
 - Original T-A® | GEN2 T-A®
 - High Performance | Universal



Indexable Insert Drills

- Protect your investment and reduce your inventory with replaceable cartridges that allow the same holder to be used repeatedly
- Indexable inserts increase productivity and tool life while reducing costs
- Products:
 - Revolution Drill®
 - Opening Drill®

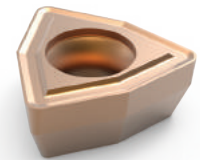

Replaceable / Indexable Insert Drills

- Allow for higher spindle speeds and take advantage of the power curve on modern CNC machines
- Achieve maximum penetration rates in deep hole drilling applications
- Holders cover a range of sizes with the replaceable heads determining the cutting diameter
- Products:
 - APX Drill



Solid Carbide Drills

- Offer greater strength and stability when drilling tougher materials
- Available in diameters from 3mm - 50mm
- Can be made-to-order specifically for your application (Superion™ quoted specials)
 - ASC 320®
 - Superion™



A DRILLING
B BORING
C REAMING
D BURNISHING
E THREADING
X SPECIALS

Structural Steel Solutions



- Deliver outstanding performance and durability in structural steel applications
- Designed to produce optimal results in difficult-to-machine materials
- Available in multiple lengths and diameters
- T-A® style drills have different insert geometry options to improve performance depending on material
- Products:
 - Original T-A® | GEN2 T-A®
 - GEN3SYS® XT

BTA (STS) Machining Solutions

- The internal ejection system flushes chips and debris from the hole with no interference to the cutting process
- Utilizes the advantages of the T-A® drill insert
- Designed to significantly increase penetration rates over brazed heads and traditional gun drills
- Products:
 - BT-A Drill



Hydraulic Port Contour Cutters

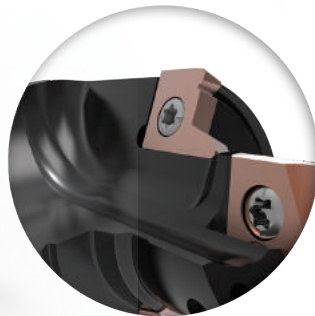

- Save significant time and money by performing four processes in one step
- Replaceable insert design reduces costs, inventory, and set-up times
- Available in 4 industry specifications:
 - Imperial: SAE J-1926
 - Metric: ISO 6149-1:2006
 - Military: SAE AS5202
 - John Deere: JDS-G173.1
- Products:
 - AccuPort 432®



Enhanced Special Drilling Capabilities

- Allied Machine Engineers are available to meet with you to evaluate your application and recommend the best solution for you
- Special drilling solutions can incorporate advanced features such as adjustable diameter locations, multiple steps, additional coolant designs, special lengths and diameters, and more
- Special drills can drastically reduce your cost-per-hole and increase your overall productivity by eliminating multiple processes and increasing tool life



Product Offering Overview

WOHLHAUPTER®

High Precision Boring Systems

- Designs available for high volume applications that increase rigidity to improve performance
- Versatile boring heads that are flexible with changing applications while maintaining excellent performance
- Provides high precision with absolute repeatability to ensure every part is held to tolerance
- Offers an industry leading modular shank connection that maintains rigidity and reduces inventory on your boring system
- Available with both digital and analog settings
- Products:
 - Wohlhaupter® Boring Tools



CRITERION™

Modular Boring Systems

- The modular capabilities are ideal for use across multiple different projects
- Offers versatile boring heads suitable for all job shops and tooling rooms
- Provides an economical solution for low volume and/or short-term production applications
- Offers both rough and finish boring solutions
- Products:
 - Criterion™ Boring Tools

S.C.A.M.I.®

Expandable Reaming Solutions

- Expandable cutting diameters accommodate for wear, which extends tool life
- Replaceable cutting heads and rings reduce waste and improve production time versus solid high speed steel and carbide reamers
- Hold tight tolerances to ensure processes are performed to accurate specifications
- Reduce tooling costs because many items are available for recondition
- Products:
 - ALVAN® Reamers

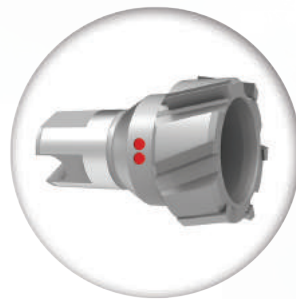

S.C.A.M.I.®

Roller Burnishing Solutions

- Produce excellent surface finishes
- Provide accurate size control
- Increase surface hardness
- Solutions for both through hole and blind hole applications
- Products:
 - S.C.A.M.I.® Roller Burnishing Tools



A DRILLING
B BORING
C REAMING
D BURNISHING
E THREADING
X SPECIALS



Solid Carbide Thread Mills

- Available with coolant through options
- Cover a wide range of thread forms
- Provide optimal solutions for both high production projects and short-run applications
- Products
 - AccuThread™ 856
 - ThreadMills USA



Indexable Insert Thread Mills

- 3 insert lengths are available that cover a wide range of thread forms
- Holders can utilize inserts with different pitches and thread forms
- Repeatability is achieved by both the bolt-in style and the pin style locking systems
- Increase tool life by 25 - 50% with Allied Machine's AM210® coating
- Products
 - AccuThread™ 856: Bolt-in Style
 - AccuThread™ 856: Pin Style

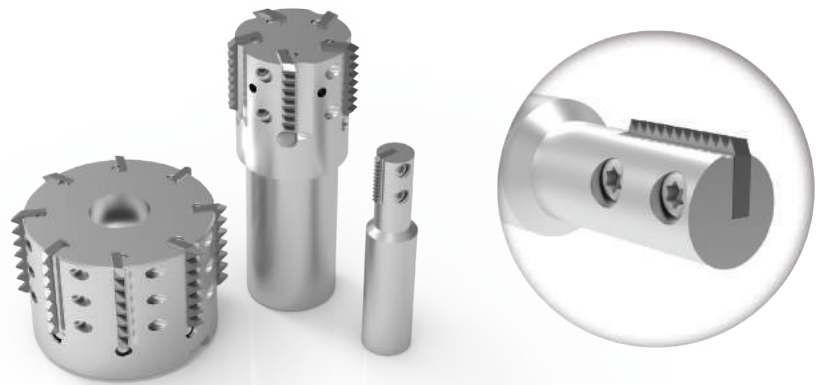

SPECIAL CAPABILITIES

When it comes to designing and developing special solutions for customers, Allied Machine is the top choice. If your application requires special tooling, give us a call. Our engineered specials are developed by the brightest engineers in the industry. Most of our standard tooling can be altered as specials, or we can create entirely new concepts for particularly unique applications.

One special tooling solution is Insta-Quote™, the online system that allows you to design your own special tooling 24/7. Receive a quote and drawings within minutes just by following the steps.

And with the addition of Superior™ technology and capabilities, we can customize made-to-order solid carbide tools to achieve optimal results for your applications.

Whatever your application, Allied Machine has the answer.



Insta-Quote™ 



 SUPERION™



Customer Support

Support You Can Count On

Allied Machine has many lines of support to ensure we're available to assist you at all times. It's important to establish relationships with new customers, but we also know it's equally important to strengthen and support relationships with existing customers. Whether you need help with an order or you need someone to come assist you at the spindle, we have the right people to get you what you need.



A DRILLING
B BORING
C REAMING
D BURNISHING
E THREADING
X SPECIALS

1

Inside Sales Support

Our inside sales team is trained to handle your account information and general inquiries. We are happy to assist you and find the answers to your questions.

- ☎ 1.330.343.4283 ext. 8610
- ☎ 1.800.321.5537 (toll free United States and Canada)
- ✉ insidesales@alliedmachine.com

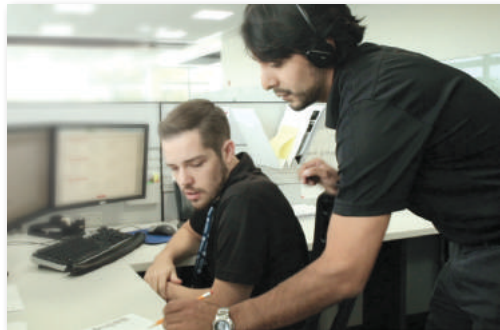

2

Engineering Support

Our highly trained and skilled Application Engineers are here to assist you. If you are experiencing technical difficulties, our engineers will recommend the best solutions to the problem. Speeds and feeds, coolant pressure, and other machining components all affect the performance of our tooling. Our AEs are experienced in working with difficult materials in many different environments. Give us a call and put our knowledge to the test.

- ☎ 1.330.343.4283 ext. 7611
- ☎ 1.800.321.5537 (toll free United States and Canada)
- ✉ appeng@alliedmachine.com

3

Field Support

Allied Machine provides local engineering support all over the world. Our Field Sales Engineers (FSEs) spend months training in-house before going to the field. This support line allows us to provide assistance to our customers right at the spindle. They are available to visit your facility, run demos and tests, and work hand-in-hand with machine operators and engineers to find the best possible tooling solutions.

NOTE: If you do not know your local FSE, please contact us

- ☎ 1.330.343.4283
- ☎ 1.800.321.5537 (toll free United States and Canada)
- ✉ info@alliedmachine.com



Customer Training

An Opportunity You Don't Want to Miss

Allied Machine's Technical Education Seminar (TES) puts the attendees in front of the machines. When you attend TES, you'll gain first-hand experience in real-life application situations. Test and experiment with different speeds and feeds, observe the results, and discover the best solution.

The training is conducted by Allied's skilled engineers, giving you the opportunity to work alongside the people who have the answers for all your application problems. You will also take guided tours of Allied Machine's two manufacturing facilities in Dover, Ohio.

TES

Technical Education Seminar



Register online today:

www.alliedmachine.com/tes



Training Lab

- In-depth training at the spindle allows you to choose the speeds and feeds
- Test the products the way you need to in order to discover the potential and the limitations in various applications
- Work side-by-side with Allied Machine's training technicians and engineers
- Witness the action of your tests and see the results up close

Learning Lab

- Quick, brief sessions in Allied Machine's learning lab provide basic knowledge to get you acclimated with the products
- Interact with Application Engineers and discuss specific issues you're experiencing in your applications
- Prepare for the training lab sessions and take your understanding and confidence in Allied Machine products to the next level



Facility Tours

- Take guided tours of Allied Machine's two manufacturing facilities located in Dover, Ohio
- Follow the path of production and see the different steps and processes involved in the manufacturing of Allied Machine products
- See the magnitude of our capabilities and learn what's in store for the future



Allied Machine
Training Facility
485 West 3rd Street
Dover, OH 44622

Navigating the Catalog

A DRILLING
B BORING
C REAMING
D BURNISHING
E THREADING
X SPECIALS

Category Identifier

This indicates the specific category within the section. For example, T-A® products are broken into series from Y to 8, so the Category Identifier will indicate which series you are viewing.

Application Identifier

The tabs along the side will help guide you to products designed for different application processes.

Imperial / Metric Identifier

These symbols will appear in the tables when it is necessary to distinguish between imperial items and metric items (most commonly noted on holders).

Safety Warnings

The safety warnings/indicators (in the table below) will appear throughout the catalog to help protect you from operations that can potentially be harmful if not performed correctly.

For items that classify as deep hole applicable, a warning is displayed to inform the user of the potential risk and direct them to the deep hole drilling guidelines for that item.

Navigation Icons

These icons will direct you to other relevant parts of the section/book. The icon reference list for each section is located on the contents page of each section.

Section Identifier and Page Number

The letter (or letter/number combination) before the page number indicates which section you are in.

NOTE: Page numbers begin at 1 in each section.

1 DRILLING | T-A® Replaceable Insert Drilling System

DRILLING

T-A Drill Insert Holders

1 Series | Straight Shank | ER Collet

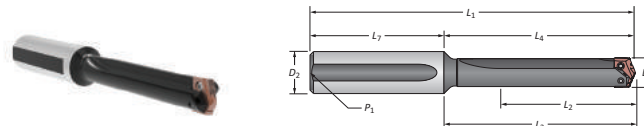

BORING

Series	Length	Body					Shank			Part No.
		D ₁	L ₂	L ₄	L ₃	L ₁	D ₂	L ₇	P ₁	
1	Short	45/64 - 15/16	2-5/8	3-7/8	4-1/64	6-7/8	3/4	3	1/8	22010S-075L
	Intermediate	45/64 - 15/16	4-5/8	5-7/8	6-1/64	8-7/8	1	3	1/8	23010S-100L
	Standard	45/64 - 15/16	6-5/8	7-7/8	8-1/64	10-7/8	3/4	3	1/8	24010S-075L
	Standard	45/64 - 15/16	6-5/8	7-7/8	8-1/64	10-7/8	1	3	1/8	24010S-100L
	Extended	45/64 - 15/16	10-5/8	11-7/8	12-1/64	14-7/8	1	3	1/8	25010S-100L
1.5	XL	45/64 - 15/16	18	19-1/4	19-25/64	22-1/4	1	3	1/8	27010S-100L
	3XL	45/64 - 15/16	22-1/4	23-1/2	23-41/64	26-1/2	1	3	1/8	29010S-100L
	Short	55/64 - 15/16	2-5/8	3-7/8	4-1/64	6-7/8	3/4	3	1/8*	22015S-075L
	Short	55/64 - 15/16	2-5/8	3-7/8	4-1/64	6-7/8	1	3	1/8*	22015S-100L
	Intermediate	55/64 - 15/16	4-5/8	5-7/8	6-1/64	8-7/8	1	3	1/8*	23015S-100L
Standard	Standard	55/64 - 15/16	6-5/8	7-7/8	8-1/64	10-7/8	3/4	3	1/8*	24015S-075L
	Standard	55/64 - 15/16	6-5/8	7-7/8	8-1/64	10-7/8	1	3	1/8*	24015S-100L
	Extended	55/64 - 15/16	10-5/8	11-7/8	12-1/64	14-7/8	1	3	1/8*	25015S-100L

REAMING

Connection Accessories

Series	Insert Screws	Nylon Locking Screws	Insert Driver	Preset Torque Hand Driver	Replacement Tips	Admissible Tightening Torque*
1	735-IP9-1	7375N-IP9-1	8IP-9	8IP-9TL	8IP-9B	27.0 in-lbs (300 N-cm)
1.5	739-IP9-1	739N-IP9-1	8IP-9	8IP-9TL	8IP-9B	27.0 in-lbs (300 N-cm)

*Tightening torques are calculated with a friction coefficient of $\mu = 0.14$ and develop 90% of ultimate yield strength

BURNISHING



Imperial (in)
Metric (mm)

Screws sold in quantities of 10

THREADING

A30: 56

www.alliedmachine.com | 1.330.343.4283

Safety Information

Your safety and the safety of others is very important. This catalog contains important safety messages. Always read and follow all safety precautions.



This triangle is a safety hazard symbol. It alerts you to potential safety hazards that can cause tool failure and serious injury.

When you see this symbol in the catalog, look for a related safety message that may be near this triangle or referred to in the nearby text.

There are safety signal words also used in the catalog. Safety messages follow these words.

WARNING

WARNING (shown above) means that failure to follow the precautions in this message could result in tool failure and serious injury.

NOTICE means that failure to follow the precautions in this message could result in damage to the tool or machine but not result in personal injury.

NOTE and **IMPORTANT** are also used. These are important that you read and follow but are not safety-related.

Visit www.alliedmachine.com for the most up-to-date information and procedures.

Patent Information

Allied Machine & Engineering patent information can be found at www.alliedmachine.com/patents



48 DRILLING | Revolution Drill® Large Diameter Replaceable IC Insert Drilling System

Revolution Drill Holders
48 Series | Diameter Range: 3.000" - 3.200" (76.2mm - 81.3mm)

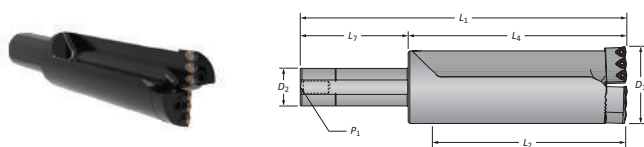

Straight Shank

Style	Length	D ₁ Range	Holder			Shank			Part No.	Cartridges
			L ₂	L ₄	L ₁	D ₂	L ₃	P ₁		
Standard	1.0xD	3.000 - 3.200	3-5/32	4-33/64	9-1/64	2	4-1/2	1/4	R48X10-200L	C48...
Standard	2.5xD	3.000 - 3.200	7-29/32	9-17/64	13-49/64	2	4-1/2	1/4	R48X25-200L	C48...
Stacked Plate	1.0xD	3.000 - 3.200	3-15/64	4-19/32	9-3/32	2	4-1/2	1/4	SP48X10-200L	C48SP...
Stacked Plate	2.5xD	3.000 - 3.200	7-63/64	9-11/32	13-27/32	2	4-1/2	1/4	SP48X25-200L	C48SP...

CV50 Shank

Style	Length	D ₁ Range	Holder		Shank	Part No.	Cartridges
			L ₂	L ₄			
Standard	1.0xD	76.2 - 81.3	80.2	114.5	50	R48X10-CV50M	C48...
Standard	2.5xD	76.2 - 81.3	200.9	235.2	50	R48X25-CV50M	C48...
Stacked Plate	1.0xD	76.2 - 81.3	82.2	116.5	50	SP48X10-CV50M	C48SP...
Stacked Plate	2.5xD	76.2 - 81.3	202.9	237.2	50	SP48X25-CV50M	C48SP...

Cartridges

Holder Part No.	Replacement Cartridges	Qty.	Inserts Needed	Mounting Screw	Adjusting Screw	Carbide Grade	Geometry	AM300®	AM200®	TIN	Insert Screws
R48...	C48-FIX	3	MS-21M-1	AS-18T9-1		CS (P35)	Standard	OP-05T308-P	OP-05T308-H	OP-05T308-T	IS-10-1
R48...	C48-ADJ	3	MS-21M-1	AS-18T9-1		C1 (K35)	Standard	OP-05T308-1P	OP-05T308-1H	OP-05T308-1T	IS-10-1
SP48...	C48SP-FIX	3	MS-21M-1	AS-18T9-1		C2 (K25)	Standard	OP-05T308-2P	OP-05T308-2H		IS-10-1
SP48...	C48SP-ADJ	3	MS-21M-1	AS-18T9-1		CS (P35)	High Rate	OP-05T308-PHR	OP-05T308-HHR		IS-10-1

IC Inserts

Mounting screws sold in multiples of 4 | Adjusting screws sold in multiples of 4
IC inserts sold in multiples of 10 | Insert screws sold in multiples of 10
⊕ = Imperial (in) | ⊗ = Metric (mm)

www.alliedmachine.com | 1.330.343.4283

Keeping Like Things Together

The sections in this catalog have been organized to keep related items together. For example, Revolution Drill® holders, cartridges, inserts, assembly screws, and accessories are all listed together by series. Therefore, you won't need to flip back and forth between pages to find all the parts needed to build a complete tool.

However, there are some instances where like items are separated. For example, T-A® inserts are grouped together by series, immediately followed by the holders and accessories for the same series. In this situation, you will need to flip between inserts and holders, but all items will still be grouped together by series.

This is when the Navigation Icons come in handy.

48 Series Holders

48 Series Cartridges and Screws

Inserts and Screws

You Can Find Your Item in the Index

If you have an item number and you're looking for that item in the catalog, you can use the index located in the back of the catalog.

Index entries will reference the first part of the item number, which will direct you to the page where your item is listed.











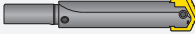

Example: Your item number is R48X10-CV50. In the index, you will find "R48X10..." listed on page A60: 16, which is where items beginning with R48X10 can be found.

R44X35...	A60: 14
R46X22...	A60: 15
R46X35...	A60: 15
R48X10...	A60: 16
R48X25...	A60: 16
R52X10...	A60: 17
R52X25...	A60: 17

A DRILLING
B BORING
C REAMING
D BURNISHING
E THREADING
X SPECIALS

Product Selection Guide

Drilling

Product	Diameter Range (inch / mm)											
	0 - 0.5 0 - 12.7	0.5 - 1 12.7 - 25.4	1 - 1.5 25.4 - 38.1	1.5 - 2 38.1 - 50.8	2 - 2.5 50.8 - 63.5	2.5 - 3 63.5 - 76.2	3 - 3.5 76.2 - 88.9	3.5 - 4 88.9 - 101.6	4 - 4.5 101.6 - 114.3	4.5 - 5 114.3 - 127	5 - 5.5 127 - 139.7	5.5 - 6 + 139.7 - 152.4 +
ASC 320® 	0.1250 - 0.7874 (3.00 - 20.00)											
GEN3SYS® XT Pro 		0.4331 - 1.3780 (11.00 - 35.00)										
GEN3SYS® XT 		0.4331 - 1.3780 (11.00 - 35.00)										
GEN2 T-A® 					0.3740 - 4.500 (9.50 - 114.30)							
Original T-A® 					0.3740 - 4.500 (9.50 - 114.30)							
High Performance 			0.9688 - 5.000 (24.60 - 127.00)									
Universal 			0.9688 - 8.500 (24.60 - 215.90)									
APX Drill 				1.4961 - 4.000 (38.00 - 101.6.30)								
Revolution Drill® 				1.8750 - 4.0000 (47.60 - 101.60)								
Opening Drill® 				2.0000 - 5.6200 (50.80 - 142.80)								
Structural Steel: GEN3SYS® XT 		0.4331 - 1.3780 (11.00 - 35.00)										
Structural Steel: T-A® 			0.5110 - 1.8820 (12.98 - 47.80)									
AccuPort 432® 		0.3860 - 2.4210 (9.80 - 61.50)										
BT-A Drill 			0.5100 - 1.8820 (12.95 - 47.80)									

▶ Any product line with a black arrow indicates that larger non-standard diameters can be ordered by contacting Application Engineering:
 ☎ 1.330.343.4283 ext. 7611 ☎ 1.800.321.5537 (toll free United States and Canada) ✉ appeng@alliedmachine.com



Online Product Selector

Have an application in your sights? You can utilize our Product Selector online to find the right tool for the job. Product Selector will provide run time parameters along with detailed information about the item(s) you need. Visit www.alliedmachine.com/ProductSelector to get started.

Length to Diameter Ratio	Machining Application					Material						Section
	General Purpose	High Penetration	Deep Hole	Large Diameter	Industry Specific	P	S	M	H	K	N	
3.5xD, 6xD, 9xD	●	●	○			●	●	●		●	●	A10
Stub, 3xD, 5xD, 7xD, 10xD	●	●	●			●				●	●	A20
Stub, 3xD, 5xD, 7xD	●	●				●	●	●	○	●	●	A20
1xD to 28xD	●	○	●	●		●	●	●		●	●	A30
1xD to 28xD	●	○	●	●		●	●	●	●	●	●	A30
	●		●	●		●	○	●		○	●	A40
	●		●	●		○	○	○		○	○	A40
3xD, 5xD, 8xD, 10xD	●		●	●		●	○	●		●	●	A50
1xD, 2.2xD, 2.5xD, 3.5xD, 4.5xD,	○	●		●		●		●	○	●	●	A60
	○	●		●		●		●	○	●	●	A70
3xD, 5xD, 7xD		○	●		●	●						A91
2xD, 4xD, 5xD, 6xD	○				●	●						A91
					●	●		○		●	●	A92
		●	●		●	●	○	○		●	●	A93

● Best ● Better ○ Good

A DRILLING
B BORING
C REAMING
D BURNISHING
E THREADING
X SPECIALS

ASC 320[®]

High Penetration Solid Carbide Drilling System

► Diameter Range: 0.1181" - 0.7874" (3.00mm - 20.00mm)

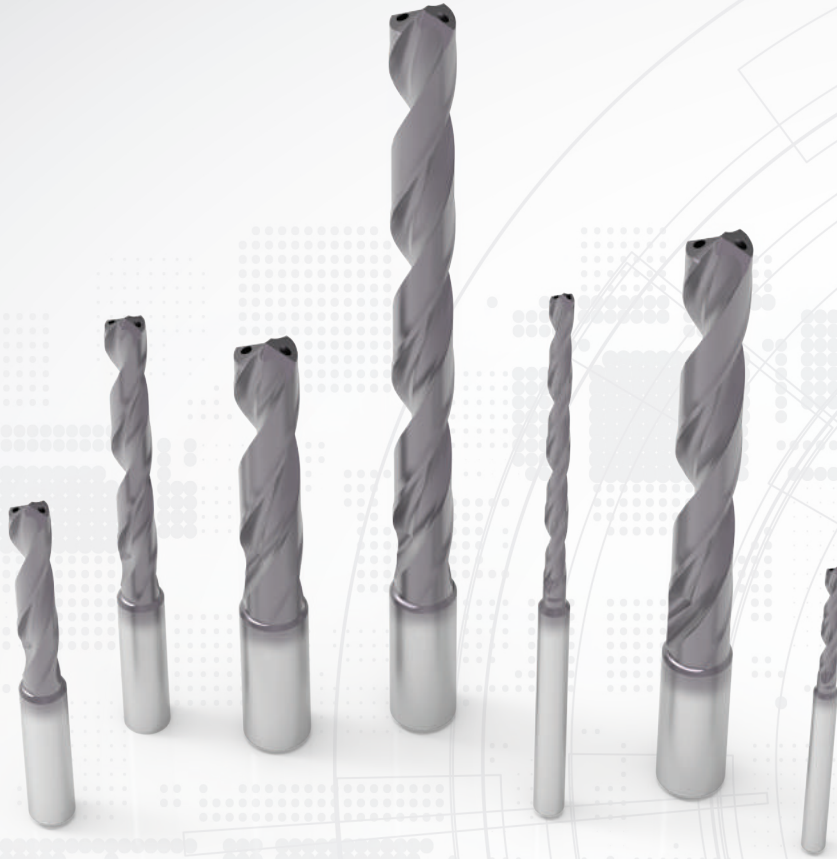

Beyond the Cutting Edge

The ASC 320 range of solid carbide high penetration drills has been specifically engineered to deliver high productivity in difficult-to-machine materials, including stainless steels, Inconel, Hastelloy, and Titanium.

The unique combination of cutting edge geometry and high performance coatings provides excellent chip control, hole quality, and extended tool life, making ASC 320 ideal for use in a wide range of challenging applications and market sectors.

Extended tool life	3.5xD, 6xD, and 9xD	Excellent chip control
--------------------	---------------------	------------------------

Applicable Industries

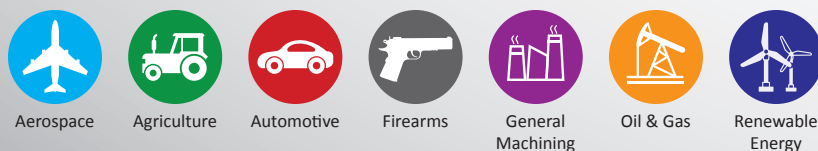

Your safety and the safety of others is very important. This catalog contains important safety messages. Always read and follow all safety precautions.



This triangle is a safety hazard symbol. It alerts you to potential safety hazards that can cause tool failure and serious injury.

When you see this symbol in the catalog, look for a related safety message that may be near this triangle or referred to in the nearby text.

There are safety signal words also used in the catalog. Safety messages follow these words.

WARNING

WARNING (shown above) means that failure to follow the precautions in this message could result in tool failure and serious injury.

NOTICE means that failure to follow the precautions in this message could result in damage to the tool or machine but not result in personal injury.

NOTE and **IMPORTANT** are also used. These are important that you read and follow but are not safety-related.

Visit www.alliedmachine.com for the most up-to-date information and procedures.

Reference Icons

The following icons will appear throughout the catalog to help you navigate between products.



Setup / Assembly Information

Detailed instructions and information regarding the corresponding part(s)

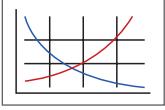

Recommended Cutting Data

Speed and feed recommendations for optimum and safe drilling

Introduction Information

Product Overview	2
Item Number Nomenclature	3

Drill Length

3.5xD	4 - 5
6xD	6 - 9
9xD	10 - 11

Recommended Cutting Data

Imperial (inch)	12
Metric (mm)	13
Coolant Recommendations	14

Product Overview

The Advantages

- ✓ **Ideal for a wide variety of applications**
with the unique geometry and coating combination
- ✓ **Increased stability**
with the reinforced shank
- ✓ **Increased tool life**
- ✓ **Excellent chip control**
- ✓ **Through coolant design**
- ✓ **Available in 3.5xD, 6xD, and 9xD lengths**

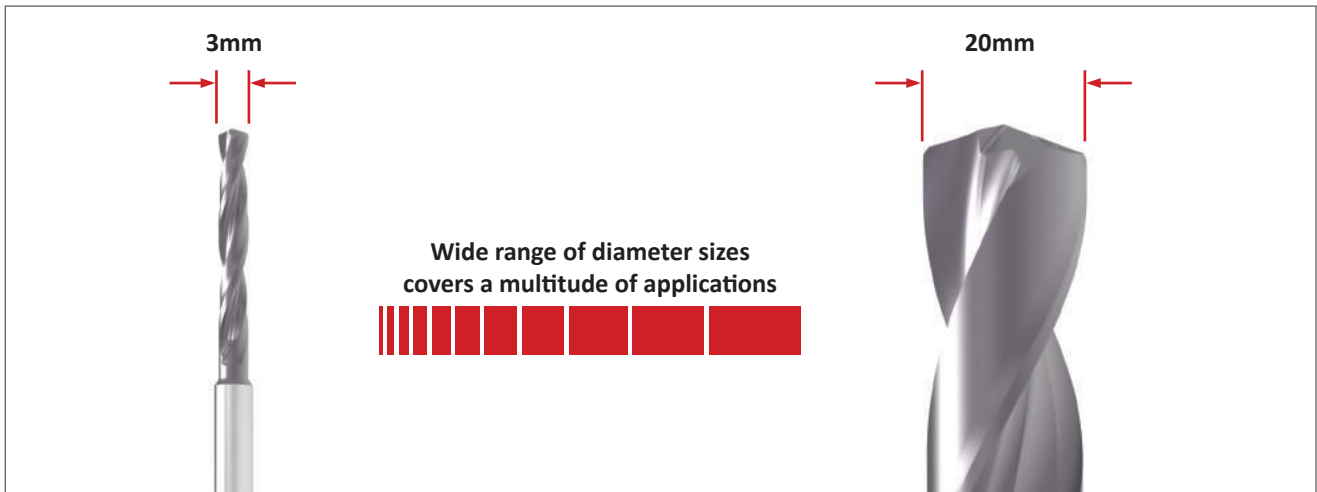

P Steel N/mm ² <1365	S High Temp Materials N/mm ² <1365	M Stainless Steel N/mm ² <940	H Hardened Materials N/mm ² <1365	K Cast and Ductile Iron N/mm ² <1020	N Non-Ferrous Materials N/mm ² <855
◆	◆	◆	❖	❖	❖

◆ First choice
❖ Second choice

A DRILLING
 B BORING
 C REAMING
 D BURISHING
 E THREADING
 X SPECIALS

Product Nomenclature

ASC 320 Solid Carbide Drills

3	60	M	07500	A21	M
1	2	3	4	5	6

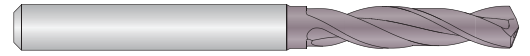

1. ASC 320®	2. Length	3. Style	4. Diameter	5. Substrate Geometry	6. Multi-Layer Coating
3 = Solid carbide	35 = 3.5xD 60 = 6xD 90 = 9xD	E = English (Imperial) M = Metric	07500 = 0.7500"	A21 = Standard	M = TiAlN

Regrind and Recoating

The ASC 320 drills are ground and recoated by Allied Machine to maintain the high level of performance achieved with these tools. Using our services assures the best tool performance is maintained in your production process.

Reference Key

Symbol	Attribute
D_1	Drill diameter
D_2	Shank diameter
L_1	Overall length
L_2	Drill depth
L_7	Shank length

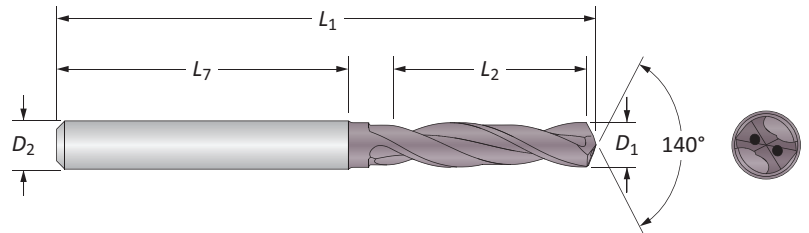

A

DRILLING

B

BORING

C

REAMING

D

BURNISHING

E

THREADING

X

SPECIALS

Solid Carbide Drills

3.5xD | Diameter Range: 0.1181" - 0.7874" (3.00mm - 20.00mm)

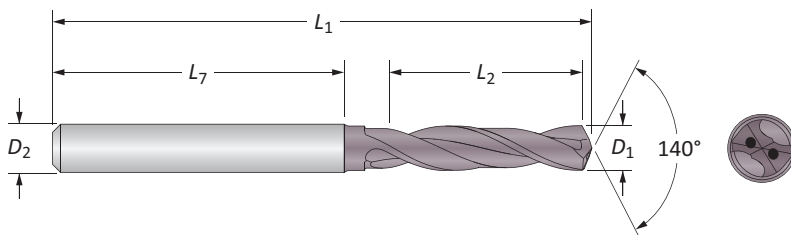

Fractional Equivalent	D ₁		Tap Size*	Body				Shank		Part No.
	inch	mm		L ₂ inch	L ₂ mm	L ₁ inch	L ₁ mm	L ₇ mm	D ₂ mm	
1/8	0.1250	3.17	-	0.551	14	2.47	62.7	36	4	335E01250A21M
-	0.1575	4.00	-	0.551	14	2.47	62.7	36	4	335M04000A21M
-	0.1654	4.20	M5x0.8	0.827	21	2.64	67.1	36	6	335M04200A21M
11/64	0.1719	4.37	-	0.827	21	2.64	67.1	36	6	335E01719A21M
#16	0.1772	4.50	#12-24	0.827	21	2.64	67.1	36	6	335M04500A21M
-	0.1811	4.60	#12-28	0.827	21	2.64	67.1	36	6	335M04600A21M
3/16	0.1875	4.76	-	0.827	21	2.64	67.1	36	6	335E01875A21M
-	0.1969	5.00	M6x1	0.827	21	2.64	67.1	36	6	335M05000A21M
13/64	0.2031	5.16	-	0.827	21	2.64	67.1	36	6	335E02031A21M
7/32	0.2188	5.56	-	0.827	21	2.64	67.1	36	6	335E02188A21M
#1	0.2280	5.79	-	0.827	21	2.64	67.1	36	6	335E02280A21M
15/64	0.2344	5.95	-	0.827	21	2.64	67.1	36	6	335E02344A21M
-	0.2362	6.00	M7x1	0.827	21	2.64	67.1	36	6	335M06000A21M
1/4	0.2500	6.35	-	1.102	28	3.13	79.4	36	8	335E02500A21M
-	0.2559	6.50	-	1.102	28	3.13	79.4	36	8	335M06500A21M
17/64	0.2656	6.75	M8x1.25	1.102	28	3.13	79.4	36	8	335E02656A21M
-	0.2756	7.00	M8x1	1.102	28	3.13	79.4	36	8	335M07000A21M
9/32	0.2812	7.14	-	1.102	28	3.13	79.4	36	8	335E02812A21M
-	0.2874	7.30	-	1.102	28	3.13	79.4	36	8	335M07300A21M
-	0.2953	7.50	-	1.102	28	3.13	79.4	36	8	335M07500A21M
19/64	0.2969	7.54	-	1.102	28	3.13	79.4	36	8	335E02969A21M
-	0.3071	7.80	-	1.102	28	3.13	79.4	36	8	335M07800A21M
5/16	0.3125	7.94	3/8-16	1.102	28	3.13	79.4	36	8	335E03125A21M
-	0.3150	8.00	-	1.102	28	3.13	79.4	36	8	335M08000A21M
21/64	0.3281	8.33	-	1.378	35	3.57	90.7	40	10	335E03281A21M
Q	0.3320	8.43	3/8-24	1.378	35	3.57	90.7	40	10	335E03320A21M
-	0.3346	8.50	M10.1.5	1.378	35	3.57	90.7	40	10	335M08500A21M
11/32	0.3438	8.73	-	1.378	35	3.57	90.7	40	10	335E03438A21M
-	0.3465	8.80	-	1.378	35	3.57	90.7	40	10	335M08800A21M
-	0.3543	9.00	-	1.378	35	3.57	90.7	40	10	335M09000A21M
23/64	0.3594	9.13	-	1.378	35	3.57	90.7	40	10	335E03594A21M
U	0.3680	9.35	7/16-14	1.378	35	3.57	90.7	40	10	335E03680A21M
-	0.3740	9.50	-	1.378	35	3.57	90.7	40	10	335M09500A21M
3/8	0.3750	9.53	-	1.378	35	3.57	90.7	40	10	335E03750A21M
-	0.3858	9.80	-	1.378	35	3.57	90.7	40	10	335E03858A21M
25/64	0.3906	9.92	7/16-20	1.378	35	3.57	90.7	40	10	335E03906A21M
-	0.3937	10.00	-	1.378	35	3.57	90.7	40	10	335M10000A21M

*Tap drill diameters allow approximately 75% of full thread to be produced

A10: 12 - 14
Key on A10: 1

A10: 2

Sizes not shown are available as non-stocked standards.
When ordering, please follow the examples shown below:

Inch	Diameter needed = 0.3450"	Part No. = 335E03450A21M
Metric	Diameter needed = 7.250mm	Part No. = 335M07250A21M

Solid Carbide Drills

3.5xD | Diameter Range: 0.1181" - 0.7874" (3.00mm - 20.00mm)

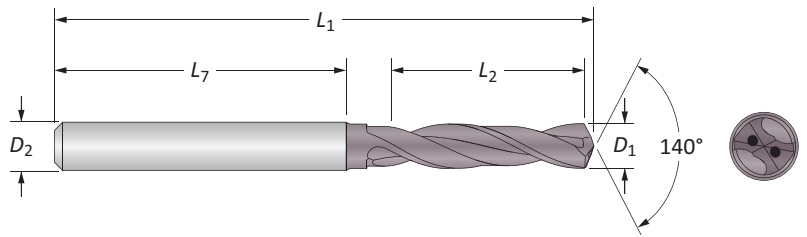

Fractional Equivalent	D ₁		Tap Size*	Body				Shank		Part No.
	inch	mm		L ₂ inch	L ₂ mm	L ₁ inch	L ₁ mm	L ₇ mm	D ₂ mm	
-	0.4016	10.20	M12x1.75	1.654	42	4.18	106.1	45	12	335M10200A21M
13/32	0.4062	10.32	-	1.378	42	4.18	106.1	45	12	335E04062A21M
-	0.4134	10.50	-	1.378	42	4.18	106.1	45	12	335M10500A21M
27/64	0.4219	10.72	1/2-13	1.654	42	4.18	106.1	45	12	335E04219A21M
-	0.4331	11.00	-	1.654	42	4.18	106.1	45	12	335M11000A21M
7/16	0.4375	11.11	-	1.654	42	4.18	106.1	45	12	335E04375A21M
-	0.4528	11.50	-	1.654	42	4.18	106.1	45	12	335M11500A21M
29/64	0.4531	11.51	1/2-20	1.654	42	4.18	106.1	45	12	335E04531A21M
15/32	0.4688	11.91	-	1.654	42	4.18	106.1	45	12	335E04688A21M
-	0.4724	12.00	M14x2	1.654	42	4.18	106.1	45	12	335M12000A21M
31/64	0.4844	12.30	9/16-12	1.929	49	4.55	115.6	45	14	335E04844A21M
-	0.4921	12.50	M14x1.5	1.929	49	4.55	115.6	45	14	335M12500A21M
1/2	0.5000	12.70	-	1.929	49	4.55	115.6	45	14	335E05000A21M
-	0.5118	13.00	-	1.929	49	4.55	115.6	45	14	335M13000A21M
33/64	0.5156	13.10	9/16-18	1.929	49	4.55	115.6	45	14	335E05156A21M
17/32	0.5312	13.49	5/8-11	1.929	49	4.55	115.6	45	14	335E05312A21M
-	0.5315	13.50	-	1.929	49	4.55	115.6	45	14	335M13500A21M
-	0.5394	13.70	-	1.929	49	4.55	115.6	45	14	335M13700A21M
35/64	0.5469	13.89	5/8-12	1.929	49	4.55	115.6	45	14	335E05469A21M
-	0.5512	14.00	M16x2	1.929	49	4.55	115.6	45	14	335M14000A21M
9/16	0.5625	14.29	-	2.205	56	5.07	128.8	48	16	335E05625A21M
-	0.5709	14.50	M16x1.5	2.205	56	5.07	128.8	48	16	335M14500A21M
37/64	0.5781	14.68	5/8-18	2.205	56	5.07	128.8	48	16	335E05781A21M
-	0.5906	15.00	-	2.205	56	5.07	128.8	48	16	335M15000A21M
19/32	0.5938	15.08	-	2.205	56	5.07	128.8	48	16	335E05938A21M
39/64	0.6094	15.48	11/16-12	2.205	56	5.07	128.8	48	16	335E06094A21M
-	0.6102	15.50	M18x2.5	2.205	56	5.07	128.8	48	16	335M15500A21M
5/8	0.6250	15.88	-	2.205	56	5.07	128.8	48	16	335E06250A21M
-	0.6299	16.00	-	2.205	56	5.07	128.8	48	16	335M16000A21M
-	0.6496	16.50	M18x1.5	2.480	63	5.44	138.2	48	18	335M16500A21M
21/32	0.6563	16.67	3/4-10	2.480	63	5.44	138.2	48	18	335E06563A21M
-	0.6693	17.00	-	2.480	63	5.44	138.2	48	18	335M17000A21M
43/64	0.6719	17.07	3/4-12	2.480	63	5.44	138.2	48	18	335E06719A21M
11/16	0.6875	17.46	3/4-16	2.480	63	5.44	138.2	48	18	335E06875A21M
-	0.6890	17.50	M20x2.5	2.480	63	5.44	138.2	48	18	335M17500A21M
45/64	0.7031	17.86	-	2.480	63	5.44	138.2	48	18	335E07031A21M
-	0.7087	18.00	-	2.480	63	5.44	138.2	48	18	335M18000A21M
-	0.7283	18.50	M20x1.5	2.756	70	5.89	149.5	50	20	335M18500A21M
47/64	0.7344	18.65	-	2.756	70	5.89	149.5	50	20	335E07344A21M
-	0.7480	19.00	-	2.756	70	5.89	149.5	50	20	335M19000A21M
-	0.7580	19.25	-	2.756	70	5.89	149.5	50	20	335E07580A21M
-	0.7677	19.50	M22x2.5	2.756	70	5.89	149.5	50	20	335M19500A21M
25/32	0.7813	19.84	-	2.756	70	5.89	149.5	50	20	335E07813A21M
-	0.7874	20.00	-	2.756	70	5.89	149.5	50	20	335M20000A21M

*Tap drill diameters allow approximately 75% of full thread to be produced

Sizes not shown are available as non-stocked standards. When ordering, please follow the examples shown below:

Inch	Diameter needed = 0.3450"	Part No. = 335E03450A21M
Metric	Diameter needed = 7.250mm	Part No. = 335M07250A21M

A10: 12 - 14 A10: 2

A DRILLING
B BORING
C REAMING
D BURNISHING
E THREADING
X SPECIALS

Solid Carbide Drills

6xD | Diameter Range: 0.1181" - 0.7874" (3.00mm - 20.00mm)

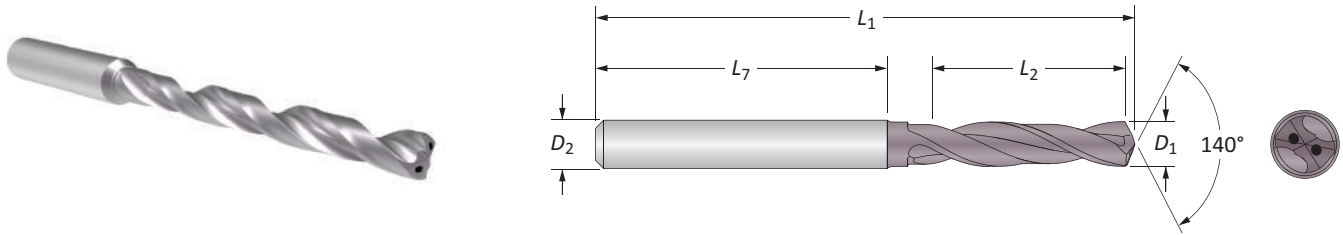

Fractional Equivalent	D ₁		Tap Size*	Body				Shank		Part No.
	inch	mm		L ₂ inch	L ₂ mm	L ₁ inch	L ₁ mm	L ₇ mm	D ₂ mm	
-	0.1181	3.00	-	0.9450	24	2.86	72.7	36	4	360M03000A21M
1/8	0.1250	3.18	-	0.9450	24	2.86	72.7	36	4	360E01250A21M
-	0.1260	3.20	-	0.9450	24	2.86	72.7	36	4	360M03200A21M
-	0.1299	3.30	M4x0.7	0.9450	24	2.86	72.7	36	4	360M03300A21M
-	0.1378	3.50	-	0.9450	24	2.86	72.7	36	4	360M03500A21M
9/64	0.1406	3.57	-	0.9450	24	2.86	72.7	36	4	360E01406A21M
#25	0.1496	3.80	#10-24	0.9450	24	2.86	72.7	36	4	360M03800A21M
5/32	0.1563	3.97	-	0.9450	24	2.86	72.7	36	4	360E01563A21M
-	0.1575	4.00	-	0.9450	24	2.86	72.7	36	4	360M04000A21M
-	0.1654	4.20	M5x0.8	1.1417	36	3.27	83.1	36	6	360M04200A21M
11/64	0.1719	4.37	-	1.1417	36	3.27	83.1	36	6	360E01719A21M
#16	0.1772	4.50	#12-24	1.1417	36	3.27	83.1	36	6	360M04500A21M
-	0.1811	4.60	#12-28	1.1417	36	3.27	83.1	36	6	360M04600A21M
-	0.1831	4.65	-	1.1417	36	3.27	83.1	36	6	360M04650A21M
3/16	0.1875	4.76	-	1.1417	36	3.27	83.1	36	6	360E01875A21M
-	0.1950	4.95	-	1.1417	36	3.27	83.1	36	6	360M04950A21M
-	0.1969	5.00	M6x1	1.1417	36	3.27	83.1	36	6	360M05000A21M
#8	0.1990	5.05	-	1.1417	36	3.27	83.1	36	6	360E01990A21M
#7	0.2010	5.11	1/4-20	1.1417	36	3.27	83.1	36	6	360E02010A21M
13/64	0.2031	5.16	-	1.1417	36	3.27	83.1	36	6	360E02031A21M
-	0.2098	5.33	-	1.1417	36	3.27	83.1	36	6	360M05330A21M
#3	0.2130	5.41	1/4-28	1.1417	36	3.27	83.1	36	6	360E02130A21M
-	0.2165	5.50	-	1.1417	36	3.27	83.1	36	6	360M05500A21M
7/32	0.2188	5.56	-	1.1417	36	3.27	83.1	36	6	360E02188A21M
#1	0.2280	5.79	-	1.1417	36	3.27	83.1	36	6	360E02280A21M
-	0.2299	5.84	-	1.1417	36	3.27	83.1	36	6	360M05840A21M
15/64	0.2344	5.95	-	1.1417	36	3.27	83.1	36	6	360E02344A21M
-	0.2362	6.00	M7x1	1.1417	36	3.27	83.1	36	6	360M06000A21M

*Tap drill diameters allow approximately 75% of full thread to be produced

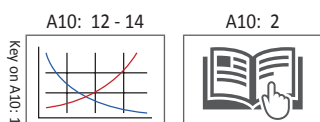

Sizes not shown are available as non-stocked standards.

When ordering, please follow the examples shown below:

Inch	Diameter needed = 0.3450"	Part No. = 335E03450A21M
Metric	Diameter needed = 7.250mm	Part No. = 335M07250A21M

Solid Carbide Drills

6xD | Diameter Range: 0.1181" - 0.7874" (3.00mm - 20.00mm)

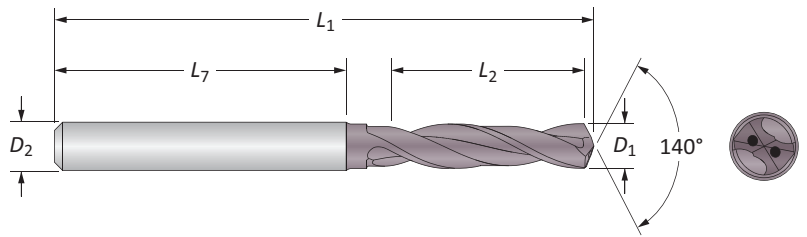

Fractional Equivalent	D ₁		Tap Size*	Body				Shank		Part No.
	inch	mm		L ₂ inch	L ₂ mm	L ₁ inch	L ₁ mm	L ₇ mm	D ₂ mm	
-	0.2398	6.09	-	1.8900	48	4.31	109.4	36	8	360M06090A21M
D	0.2460	6.25	-	1.8900	48	4.31	109.4	36	8	360E02460A21M
1/4	0.2500	6.35	-	1.8900	48	4.31	109.4	36	8	360E02500A21M
-	0.2559	6.50	-	1.8900	48	4.31	109.4	36	8	360M06500A21M
F	0.2570	6.53	5/16-18	1.8900	48	4.31	109.4	36	8	360E02570A21M
17/64	0.2656	6.75	M8x1.25	1.8900	48	4.31	109.4	36	8	360E02656A21M
-	0.2677	6.80	-	1.8900	48	4.31	109.4	36	8	360M06800A21M
I	0.2720	6.91	5/16-24	1.8900	48	4.31	109.4	36	8	360E02720A21M
-	0.2756	7.00	M8x1	1.8900	48	4.31	109.4	36	8	360M07000A21M
-	0.2795	7.10	-	1.8900	48	4.31	109.4	36	8	360M07100A21M
9/32	0.2812	7.14	-	1.8900	48	4.31	109.4	36	8	360E02812A21M
-	0.2874	7.30	-	1.8900	48	4.31	109.4	36	8	360M07300A21M
-	0.2913	7.40	-	1.8900	48	4.31	109.4	36	8	360M07400A21M
-	0.2953	7.50	-	1.890	48	4.31	109.4	36	8	360M07500A21M
19/64	0.2969	7.54	-	1.890	48	4.31	109.4	36	8	360E02969A21M
5/16	0.3125	7.94	3/8-16	1.890	48	4.31	109.4	36	8	360E03125A21M
-	0.3150	8.00	-	1.890	48	4.31	109.4	36	8	360M08000A21M
21/64	0.3281	8.33	-	2.362	60	4.56	115.4	40	10	360E03281A21M
Q	0.3320	8.43	3/8-24	2.362	60	4.56	115.4	40	10	360M08430A21M
-	0.3346	8.50	M10x1.5	2.362	60	4.56	115.4	40	10	360M08500A21M
-	0.3386	8.60	-	2.362	60	4.56	115.4	40	10	360M08600A21M
11/32	0.3438	8.73	-	2.362	60	4.56	115.4	40	10	360E03438A21M
-	0.3465	8.80	-	2.362	60	4.56	115.4	40	10	360M08800A21M
-	0.3543	9.00	-	2.362	60	4.56	115.4	40	10	360M09000A21M
23/64	0.3594	9.13	-	2.362	60	4.56	115.4	40	10	360E03594A21M
-	0.3622	9.20	-	2.362	60	4.56	115.4	40	10	360M09200A21M
U	0.3680	9.35	7/16-14	2.362	60	4.56	115.4	40	10	360E03680A21M
-	0.3730	9.47	-	2.362	60	4.56	115.4	40	10	360M09470A21M
-	0.3740	9.50	-	2.362	60	4.56	115.4	40	10	360M09500A21M
3/8	0.3750	9.53	-	2.362	60	4.56	115.4	40	10	360E03750A21M
-	0.3780	9.60	-	2.362	60	4.56	115.4	40	10	360M09600A21M
-	0.3820	9.70	-	2.362	60	4.56	115.4	40	10	360M09700A21M
25/64	0.3906	9.92	7/16-20	2.362	60	4.56	115.4	40	10	360E03906A21M
-	0.3937	10.00	-	2.362	60	4.56	115.4	40	10	360M10000A21M

*Tap drill diameters allow approximately 75% of full thread to be produced

A10: 12 - 14

A10: 2

Sizes not shown are available as non-stocked standards. When ordering, please follow the examples shown below:

Inch	Diameter needed = 0.3450"	Part No. = 335E03450A21M
Metric	Diameter needed = 7.250mm	Part No. = 335M07250A21M

A DRILLING B BORING C REAMING D BURNISHING E THREADING X SPECIALS

Solid Carbide Drills

6xD | Diameter Range: 0.1181" - 0.7874" (3.00mm - 20.00mm)

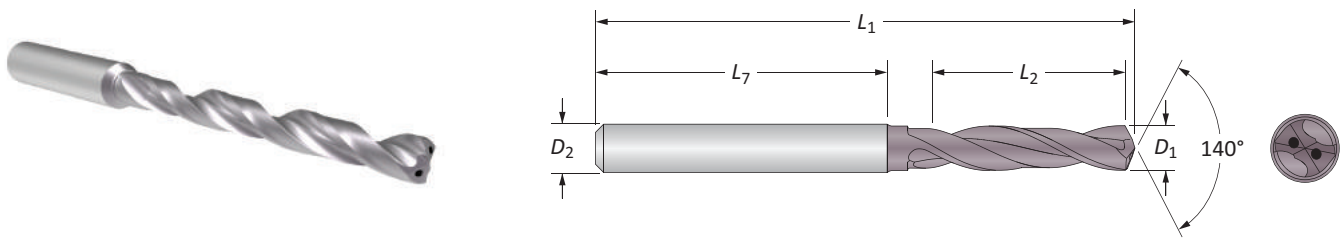

Fractional Equivalent	D ₁		Tap Size*	Body				Shank		Part No.
	inch	mm		L ₂ inch	L ₂ mm	L ₁ inch	L ₁ mm	L ₇ mm	D ₂ mm	
-	0.4016	10.20	M12x1.75	2.835	72	5.36	136.2	45	12	360M10200A21M
Y	0.4040	10.31	-	2.835	72	5.36	136.2	45	12	360E04040A21M
13/32	0.4062	10.32	-	2.835	72	5.36	136.2	45	12	360E04062A21M
-	0.4134	10.50	-	2.835	72	5.36	136.2	45	12	360M10500A21M
27/64	0.4219	10.72	1/2-13	2.835	72	5.36	136.2	45	12	360E04219A21M
-	0.4252	10.80	M12x4.25	2.835	72	5.36	136.2	45	12	360M10800A21M
-	0.4290	10.90	-	2.835	72	5.36	136.2	45	12	360M10900A21M
-	0.4331	11.00	-	2.835	72	5.36	136.2	45	12	360M11000A21M
7/16	0.4375	11.11	-	2.835	72	5.36	136.2	45	12	360E04375A21M
-	0.4409	11.20	-	2.835	72	5.36	136.2	45	12	360M11200A21M
-	0.4528	11.50	-	2.835	72	5.36	136.2	45	12	360M11500A21M
29/64	0.4531	11.51	1/2-20	2.835	72	5.36	136.2	45	12	360E04531A21M
-	0.4646	11.80	-	2.835	72	5.36	136.2	45	12	360M11800A21M
15/32	0.4688	11.91	-	2.835	72	5.36	136.2	45	12	360E04688A21M
-	0.4724	12.00	M14x2	2.835	72	5.36	136.2	45	12	360M12000A21M
31/64	0.4844	12.30	9/16-12	3.307	84	5.93	150.5	45	14	360E04844A21M
-	0.4921	12.50	M14x1.5	3.307	84	5.93	150.5	45	14	360M12500A21M
1/2	0.5000	12.70	-	3.307	84	5.93	150.5	45	14	360E05000A21M
-	0.5100	12.95	-	3.307	84	5.93	150.5	45	14	360M12950A21M
-	0.5118	13.00	-	3.307	84	5.93	150.5	45	14	360M13000A21M
33/64	0.5156	13.10	9/16-18	3.307	84	5.93	150.5	45	14	360E05156A21M
-	0.5197	13.20	-	3.307	84	5.93	150.5	45	14	360M13200A21M
17/32	0.5312	13.49	5/8-11	3.307	84	5.93	150.5	45	14	360E05312A21M
-	0.5315	13.50	-	3.307	84	5.93	150.5	45	14	360M13500A21M
-	0.5433	13.80	-	3.307	84	5.93	150.5	45	14	360M13800A21M
35/64	0.5469	13.89	5/8-12	3.307	84	5.93	150.5	45	14	360E05469A21M
-	0.5512	14.00	M16x2	3.307	84	5.93	150.5	45	14	360M14000A21M
9/16	0.5625	14.29	-	3.780	96	6.65	168.9	48	16	360E05625A21M
-	0.5709	14.50	M16x1.5	3.780	96	6.65	168.9	48	16	360M14500A21M
37/64	0.5781	14.68	5/8-18	3.780	96	6.65	168.9	48	16	360E05781A21M
-	0.5906	15.00	-	3.780	96	6.65	168.9	48	16	360M15000A21M
19/32	0.5938	15.08	-	3.780	96	6.65	168.9	48	16	360E05938A21M
39/64	0.6094	15.48	11/16-12	3.780	96	6.65	168.9	48	16	360E06094A21M
-	0.6102	15.50	M18x2.5	3.780	96	6.65	168.9	48	16	360M15500A21M
5/8	0.6250	15.88	-	3.780	96	6.65	168.9	48	16	360E06250A21M
-	0.6299	16.00	-	3.780	96	6.65	168.9	48	16	360M16000A21M

*Tap drill diameters allow approximately 75% of full thread to be produced

A10: 12 - 14

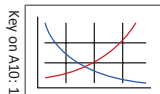

A10: 2



Sizes not shown are available as non-stocked standards.

When ordering, please follow the examples shown below:

Inch	Diameter needed = 0.3450"	Part No. = 335E03450A21M
Metric	Diameter needed = 7.250mm	Part No. = 335M07250A21M

Solid Carbide Drills

6xD | Diameter Range: 0.1181" - 0.7874" (3.00mm - 20.00mm)

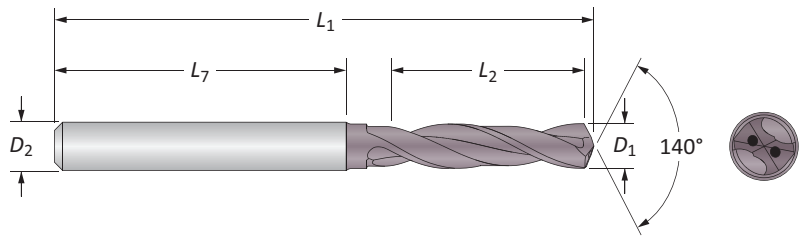

Fractional Equivalent	D ₁		Tap Size*	Body				Shank		Part No.
	inch	mm		L ₂ inch	L ₂ mm	L ₁ inch	L ₁ mm	L ₇ mm	D ₂ mm	
-	0.6307	16.02	-	4.252	108	7.22	183.3	48	18	360M16020A21M
-	0.6331	16.08	-	4.252	108	7.22	183.3	48	18	360M16080A21M
-	0.6378	16.20	-	4.252	108	7.22	183.3	48	18	360M16200A21M
41/64	0.6406	16.27	-	4.252	108	7.22	183.3	48	18	360E06406A21M
-	0.6496	16.50	M18x1.5	4.252	108	7.22	183.3	48	18	360M16500A21M
21/32	0.6563	16.67	3/4-10	4.252	108	7.22	183.3	48	18	360E06563A21M
-	0.6693	17.00	-	4.252	108	7.22	183.3	48	18	360M17000A21M
43/64	0.6719	17.07	3/4-12	4.252	108	7.22	183.3	48	18	360E06719A21M
11/16	0.6875	17.46	3/4-16	4.252	108	7.22	183.3	48	18	360E06875A21M
-	0.6890	17.50	M20x2.5	4.252	108	7.22	183.3	48	18	360M17500A21M
45/64	0.7031	17.86	-	4.252	108	7.22	183.3	48	18	360E07031A21M
-	0.7087	18.00	-	4.252	108	7.22	183.3	48	18	360M18000A21M
-	0.7098	18.03	-	4.724	120	7.86	199.6	50	20	360M18030A21M
23/32	0.7188	18.26	-	4.724	120	7.86	199.6	50	20	360E07188A21M
-	0.7283	18.50	M20x1.5	4.724	120	7.86	199.6	50	20	360M18500A21M
47/64	0.7344	18.65	-	4.724	120	7.86	199.6	50	20	360E07344A21M
-	0.7480	19.00	-	4.724	120	7.86	199.6	50	20	360M19000A21M
3/4	0.7500	19.05	-	4.724	120	7.86	199.6	50	20	360E07500A21M
-	0.7520	19.10	-	4.724	120	7.86	199.6	50	20	360M19100A21M
-	0.7535	19.14	-	4.724	120	7.86	199.6	50	20	360M19140A21M
-	0.7543	19.16	-	4.724	120	7.86	199.6	50	20	360M19160A21M
-	0.7559	19.20	-	4.724	120	7.86	199.6	50	20	360M19200A21M
-	0.7580	19.25	-	4.724	120	7.86	199.6	50	20	360E07580A21M
-	0.7598	19.30	-	4.724	120	7.86	199.6	50	20	360M19300A21M
49/64	0.7656	19.45	7/8-9	4.724	120	7.86	199.6	50	20	360E07656A21M
-	0.7677	19.50	M22x2.5	4.724	120	7.86	199.6	50	20	360M19500A21M
25/32	0.7813	19.84	-	4.724	120	7.86	199.6	50	20	360E07813A21M
-	0.7874	20.00	-	4.724	120	7.86	199.6	50	20	360M20000A21M

*Tap drill diameters allow approximately 75% of full thread to be produced

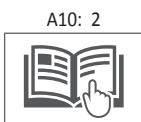
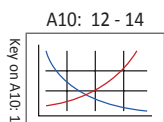

Sizes not shown are available as non-stocked standards. When ordering, please follow the examples shown below:

Inch	Diameter needed = 0.3450"	Part No. = 335E03450A21M
Metric	Diameter needed = 7.250mm	Part No. = 335M07250A21M

A
DRILLING
B
BORING
C
REAMING
D
BURNISHING
E
THREADING
X
SPECIALS

Solid Carbide Drills

9xD | Diameter Range: 0.1181" - 0.7874" (3.00mm - 20.00mm)

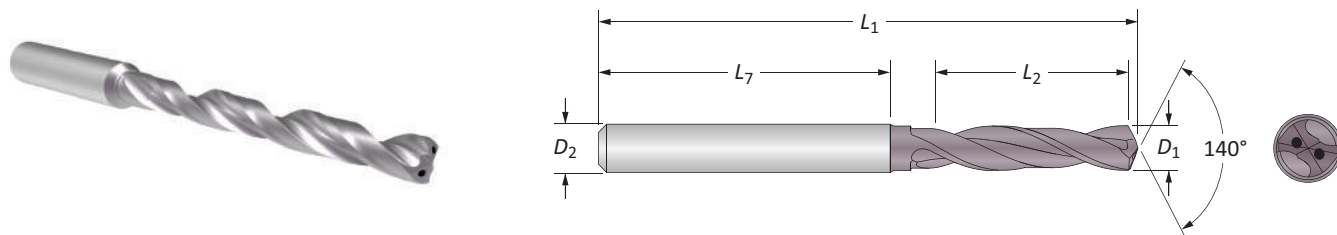

Fractional Equivalent	D ₁		Tap Size*	Body				Shank		Part No.
	inch	mm		L ₂ inch	L ₂ mm	L ₁ inch	L ₁ mm	L ₇ mm	D ₂ mm	
-	0.1969	5.00	M6x1	2.126	54	3.98	101.1	36	6	390M05000A21M
-	0.2362	6.00	M7x1	2.126	54	3.98	101.1	36	6	390M06000A21M
D	0.2461	6.25	-	2.835	72	4.86	123.4	36	8	390E02461A21M
1/4	0.2500	6.35	-	2.835	72	4.86	123.4	36	8	390E02500A21M
-	0.2559	6.50	-	2.835	72	4.86	123.4	36	8	390M06500A21M
17/64	0.2656	6.75	M8x1.25	2.835	72	4.86	123.4	36	8	390E02656A21M
I	0.2720	6.91	5/16-24	2.835	72	4.86	123.4	36	8	390E02720A21M
-	0.2756	7.00	M8x1	2.835	72	4.86	123.4	36	8	390M07000A21M
-	0.2953	7.50	-	2.835	72	4.86	123.4	36	8	390M07500A21M
19/64	0.2969	7.54	-	2.835	72	4.86	123.4	36	8	390E02969A21M
5/16	0.3125	7.94	3/8-16	2.835	72	4.86	123.4	36	8	390E03125A21M
-	0.3150	8.00	-	2.835	72	4.86	123.4	36	8	390M08000A21M
21/64	0.3281	8.33	-	3.543	90	5.74	145.8	40	10	390E03281A21M
Q	0.3319	8.43	3/8-24	3.543	90	5.74	145.8	40	10	390M08430A21M
-	0.3346	8.50	M10x1.5	3.543	90	5.74	145.8	40	10	390M08500A21M
-	0.3386	8.60	-	3.543	90	5.74	145.8	40	10	390M08600A21M
11/32	0.3438	8.73	-	3.543	90	5.74	145.8	40	10	390E03438A21M
-	0.3465	8.80	-	3.543	90	5.74	145.8	40	10	390M08800A21M
-	0.3543	9.00	-	3.543	90	5.74	145.8	40	10	390M09000A21M
23/64	0.3594	9.13	-	3.543	90	5.74	145.8	40	10	390E03594A21M
U	0.3680	9.35	7/16-14	3.543	90	5.74	145.8	40	10	390E03680A21M
-	0.3740	9.50	-	3.543	90	5.74	145.8	40	10	390M09500A21M
3/8	0.3750	9.53	-	3.543	90	5.74	145.8	40	10	390E03750A21M
-	0.3780	9.60	-	3.543	90	5.74	145.8	40	10	390M09600A21M
25/64	0.3906	9.92	7/16-20	3.543	90	5.74	145.8	40	10	390E03906A21M
-	0.3937	10.00	-	3.543	90	5.74	145.8	40	10	390M10000A21M
-	0.4016	10.20	M12x1.75	4.252	108	6.78	172.2	45	12	390M10200A21M
-	0.4040	10.26	-	4.252	108	6.78	172.2	45	12	390E04040A21M
13/32	0.4062	10.32	-	4.252	108	6.78	172.2	45	12	390E04062A21M
-	0.4134	10.50	-	4.252	108	6.78	172.2	45	12	390M10500A21M
27/64	0.4219	10.72	1/2-13	4.252	108	6.78	172.2	45	12	390E04219A21M
-	0.4331	11.00	-	4.252	108	6.78	172.2	45	12	390M11000A21M
7/16	0.4375	11.11	-	4.252	108	6.78	172.2	45	12	390E04375A21M
-	0.4528	11.50	-	4.252	108	6.78	172.2	45	12	390M11500A21M
29/64	0.4531	11.51	1/2-20	4.252	108	6.78	172.2	45	12	390E04531A21M
15/32	0.4688	11.91	-	4.252	108	6.78	172.2	45	12	390E04688A21M
-	0.4724	12.00	M14x2	4.252	108	6.78	172.2	45	12	390M12000A21M

*Tap drill diameters allow approximately 75% of full thread to be produced

A10: 12 - 14

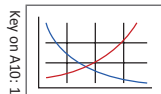

A10: 2



Sizes not shown are available as non-stocked standards.

When ordering, please follow the examples shown below:

Inch	Diameter needed = 0.3450"	Part No. = 335E03450A21M
Metric	Diameter needed = 7.250mm	Part No. = 335M07250A21M



Solid Carbide Drills

9xD | Diameter Range: 0.1181" - 0.7874" (3.00mm - 20.00mm)

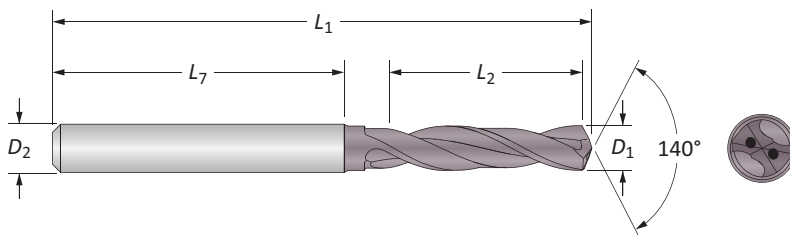

Fractional Equivalent	D ₁		Tap Size*	Body				Shank		Part No.
	inch	mm		L ₂ inch	L ₂ mm	L ₁ inch	L ₁ mm	L ₇ mm	D ₂ mm	
31/64	0.4844	12.30	9/16-12	4.961	126	7.58	192.5	45	14	390E04844A21M
-	0.4921	12.50	M14x1.5	4.961	126	7.58	192.5	45	14	390M12500A21M
1/2	0.5000	12.70	-	4.961	126	7.58	192.5	45	14	390E05000A21M
-	0.5118	13.00	-	4.961	126	7.58	192.5	45	14	390M13000A21M
33/64	0.5156	13.10	9/16-18	4.961	126	7.58	192.5	45	14	390E05156A21M
17/32	0.5312	13.49	5/8-11	4.961	126	7.58	192.5	45	14	390E05312A21M
-	0.5315	13.50	-	4.961	126	7.58	192.5	45	14	390M13500A21M
35/64	0.5469	13.89	5/8-12	4.961	126	7.58	192.5	45	14	390E05469A21M
-	0.5512	14.00	M16x2	4.961	126	7.58	192.5	45	14	390M14000A21M
9/16	0.5625	14.29	-	5.669	144	8.54	216.9	48	16	390E05625A21M
-	0.5709	14.50	M16x1.5	5.669	144	8.54	216.9	48	16	390M14500A21M
37/64	0.5781	14.68	5/8-18	5.669	144	8.54	216.9	48	16	390E05781A21M
-	0.5906	15.00	-	5.669	144	8.54	216.9	48	16	390M15000A21M
19/32	0.5938	15.08	-	5.669	144	8.54	216.9	48	16	390E05938A21M
39/64	0.6094	15.48	11/16-12	5.669	144	8.54	216.9	48	16	390E06094A21M
-	0.6102	15.50	M18x2.5	5.669	144	8.54	216.9	48	16	390M15500A21M
5/8	0.6250	15.88	-	5.669	144	8.54	216.9	48	16	390E06250A21M
-	0.6299	16.00	-	5.669	144	8.54	216.9	48	16	390M16000A21M
41/64	0.6406	16.27	-	6.378	162	9.34	237.3	48	18	390E06406A21M
-	0.6496	16.50	M18x1.5	6.378	162	9.34	237.3	48	18	390M16500A21M
21/32	0.6563	16.67	3/4-10	6.378	162	9.34	237.3	48	18	390E06563A21M
-	0.6693	17.00	-	6.378	162	9.34	237.3	48	18	390M17000A21M
43/64	0.6719	17.07	3/4-12	6.378	162	9.34	237.3	48	18	390E06719A21M
11/16	0.6875	17.46	3/4-16	6.378	162	9.34	237.3	48	18	390E06875A21M
-	0.6890	17.50	M20x2.5	6.378	162	9.34	237.3	48	18	390M17500A21M
45/64	0.7031	17.86	-	6.378	162	9.34	237.3	48	18	390E07031A21M
-	0.7087	18.00	-	6.378	162	9.34	237.3	48	18	390M18000A21M
23/32	0.7188	18.26	-	7.087	180	10.22	259.6	50	20	390E07188A21M
-	0.7283	18.50	M20x1.5	7.087	180	10.22	259.6	50	20	390M18500A21M
47/64	0.7344	18.65	-	7.087	180	10.22	259.6	50	20	390E07344A21M
-	0.7480	19.00	-	7.087	180	10.22	259.6	50	20	390M19000A21M
3/4	0.7500	19.05	-	7.087	180	10.22	259.6	50	20	390E07500A21M
49/64	0.7656	19.45	7/8-09	7.087	180	10.22	259.6	50	20	390E07656A21M
-	0.7677	19.50	M22x2.5	7.087	180	10.22	259.6	50	20	390M19500A21M
25/32	0.7813	19.84	-	7.087	180	10.22	259.6	50	20	390E07813A21M
-	0.7874	20.00	-	7.087	180	10.22	259.6	50	20	390M20000A21M

*Tap drill diameters allow approximately 75% of full thread to be produced

A10: 12 - 14

A10: 2

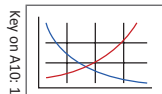

Sizes not shown are available as non-stocked standards. When ordering, please follow the examples shown below:

Inch	Diameter needed = 0.3450"	Part No. = 335E03450A21M
Metric	Diameter needed = 7.250mm	Part No. = 335M07250A21M

Recommended Drilling Data | Imperial (inch)

ISO	Material	Hardness (BHN)	Speed (SFM)	Feed Rate (IPR) by Diameter								
				0.118 - 0.157	0.161 - 0.236	0.240 - 0.315	0.319 - 0.394	0.398 - 0.472	0.476 - 0.551	0.555 - 0.630	0.634 - 0.709	0.713 - 0.787
P	Free Machining Steel 1118, 1215, 12L14, etc.	100 - 150	450	0.007	0.009	0.011	0.013	0.014	0.016	0.018	0.020	0.022
		150 - 200	400	0.005	0.008	0.009	0.011	0.012	0.014	0.016	0.018	0.020
		200 - 250	375	0.004	0.006	0.007	0.009	0.010	0.012	0.014	0.016	0.018
	Low Carbon Steel 1010, 1020, 1025, 1522, 1144, etc.	85 - 125	425	0.007	0.009	0.011	0.013	0.015	0.017	0.019	0.019	0.021
		125 - 175	390	0.006	0.008	0.010	0.012	0.014	0.016	0.018	0.018	0.020
		175 - 225	360	0.005	0.008	0.010	0.011	0.013	0.015	0.017	0.017	0.019
	Medium Carbon Steel 1030, 1040, 1050, 1527, 1140, 1151, etc.	225 - 275	330	0.004	0.007	0.009	0.010	0.012	0.014	0.016	0.016	0.018
		125 - 175	390	0.006	0.008	0.010	0.012	0.013	0.014	0.016	0.018	0.020
		175 - 225	360	0.005	0.007	0.010	0.012	0.012	0.013	0.015	0.017	0.019
	Alloy Steel 4140, 5140, 8640, etc.	225 - 275	320	0.004	0.006	0.009	0.011	0.011	0.012	0.014	0.016	0.018
		275 - 325	285	0.003	0.006	0.008	0.010	0.010	0.011	0.013	0.015	0.017
		175 - 225	375	0.006	0.008	0.010	0.012	0.013	0.014	0.016	0.018	0.020
	High Strength Alloy 4340, 4330V, 300M, etc.	225 - 275	340	0.005	0.007	0.009	0.011	0.012	0.013	0.015	0.017	0.019
		275 - 325	300	0.004	0.006	0.008	0.010	0.011	0.012	0.013	0.016	0.018
		325 - 375	275	0.003	0.005	0.007	0.009	0.010	0.010	0.012	0.014	0.016
	Structural Steel A36, A285, A516, etc.	225 - 300	260	0.005	0.007	0.008	0.011	0.011	0.012	0.013	0.014	0.016
		300 - 350	210	0.004	0.006	0.007	0.009	0.010	0.011	0.012	0.013	0.015
		350 - 400	160	0.003	0.005	0.006	0.008	0.009	0.010	0.011	0.012	0.013
Tool Steel H-13, H-21, A-4, O-2, S-3, etc.	100 - 150	360	0.005	0.008	0.009	0.011	0.012	0.013	0.014	0.016	0.018	
	150 - 250	320	0.004	0.007	0.008	0.010	0.011	0.012	0.013	0.015	0.017	
	250 - 350	270	0.003	0.005	0.007	0.008	0.009	0.010	0.011	0.013	0.015	
S	High Temp Alloy Hastelloy B, Inconel 600, etc.	150 - 200	260	0.003	0.004	0.005	0.006	0.007	0.008	0.009	0.010	0.011
		200 - 250	220	0.002	0.003	0.004	0.005	0.006	0.007	0.008	0.009	0.010
M	Stainless Steel 300 Series 304, 316, 17-4PH, etc.	140 - 220	120	0.003	0.004	0.005	0.006	0.007	0.008	0.009	0.010	0.011
		220 - 310	90	0.002	0.003	0.003	0.004	0.005	0.006	0.007	0.008	0.009
K	Nodular, Grey, Ductile Cast Iron	135 - 185	200	0.004	0.005	0.006	0.007	0.008	0.009	0.011	0.012	0.013
		185 - 275	140	0.003	0.004	0.004	0.005	0.006	0.007	0.009	0.010	0.011
		120 - 150	550	0.008	0.010	0.012	0.014	0.016	0.018	0.020	0.022	0.024
		150 - 200	500	0.008	0.010	0.012	0.014	0.016	0.018	0.020	0.022	0.024
		200 - 220	475	0.007	0.009	0.011	0.013	0.015	0.017	0.019	0.021	0.023
N	Cast Aluminum	220 - 260	430	0.007	0.009	0.011	0.013	0.015	0.017	0.019	0.021	0.023
		260 - 320	400	0.006	0.008	0.010	0.012	0.014	0.016	0.018	0.020	0.022
		30	1500	0.008	0.010	0.013	0.015	0.017	0.020	0.022	0.024	0.026
Wrought Aluminum	180	1000	0.006	0.008	0.011	0.013	0.015	0.018	0.020	0.022	0.024	
	30	1500	0.008	0.010	0.013	0.015	0.017	0.020	0.022	0.024	0.026	
		180	1000	0.006	0.008	0.011	0.013	0.015	0.018	0.020	0.022	0.024

Speed and Feed Adjustment

3.5xD	6xD	9xD
See above chart	0.90	0.75

Recommended Speed and Feed Example

If the recommended speed and feed is 300 SFM and 0.010 IPR, then reduce to 225 SFM and 0.0075 IPR when using a 9xD tool	
$300 \cdot 0.75 = 225 \text{ SFM}$	$0.010 \cdot 0.75 = 0.0075 \text{ IPR}$

Calculations

Value	Formula
IPM	$\text{RPM} \cdot \text{IPR}$
SFM	$\text{RPM} \cdot 0.262 \cdot \text{DIA}$
RPM	$(\text{SFM} \cdot 3.82) / \text{DIA}$

IMPORTANT: The speeds and feeds listed above are a general starting point for all applications. Refer to the Coolant Recommendation charts for coolant requirements to run at the recommended speeds and feeds. Factory technical assistance is available through our Application Engineering department.

Recommended Drilling Data | Metric (mm)

ISO	Material	Hardness (BHN)	Speed (M/min)	Feed Rate (mm/rev) by Diameter								
				3.00 - 4.00	4.01 - 6.00	6.01 - 8.00	8.01 - 10.00	10.01 - 12.00	12.01 - 14.00	14.01 - 16.00	16.01 - 18.00	18.01 - 20.00
P	Free Machining Steel 1118, 1215, 12L14, etc.	100 - 150	137	0.18	0.23	0.28	0.33	0.36	0.41	0.46	0.51	0.56
		150 - 200	122	0.13	0.20	0.23	0.28	0.30	0.36	0.41	0.46	0.51
		200 - 250	114	0.10	0.15	0.18	0.23	0.25	0.30	0.36	0.41	0.46
	Low Carbon Steel 1010, 1020, 1025, 1522, 1144, etc.	85 - 125	130	0.18	0.23	0.28	0.33	0.38	0.43	0.48	0.48	0.53
		125 - 175	119	0.15	0.20	0.25	0.30	0.36	0.41	0.46	0.46	0.51
		175 - 225	110	0.13	0.20	0.25	0.28	0.33	0.38	0.43	0.43	0.48
	Medium Carbon Steel 1030, 1040, 1050, 1527, 1140, 1151, etc.	225 - 275	101	0.10	0.18	0.23	0.25	0.30	0.36	0.41	0.41	0.46
		125 - 175	119	0.15	0.20	0.25	0.30	0.33	0.36	0.41	0.46	0.51
		175 - 225	110	0.13	0.18	0.25	0.30	0.30	0.33	0.38	0.43	0.48
	Alloy Steel 4140, 5140, 8640, etc.	225 - 275	98	0.10	0.15	0.23	0.28	0.28	0.30	0.36	0.41	0.48
		275 - 325	87	0.08	0.15	0.20	0.25	0.25	0.28	0.33	0.38	0.43
		275 - 325	91	0.10	0.15	0.20	0.25	0.28	0.30	0.33	0.41	0.46
	High Strength Alloy 4340, 4330V, 300M, etc.	325 - 375	84	0.08	0.13	0.18	0.23	0.25	0.25	0.30	0.36	0.41
		225 - 300	79	0.13	0.18	0.20	0.28	0.28	0.30	0.33	0.36	0.41
		300 - 350	64	0.10	0.15	0.18	0.23	0.25	0.28	0.30	0.33	0.38
	Structural Steel A36, A285, A516, etc.	350 - 400	49	0.08	0.13	0.15	0.20	0.23	0.25	0.28	0.30	0.33
		100 - 150	110	0.13	0.20	0.23	0.28	0.30	0.33	0.36	0.41	0.46
		150 - 250	98	0.10	0.18	0.20	0.25	0.28	0.30	0.33	0.38	0.43
Tool Steel H-13, H-21, A-4, O-2, S-3, etc.	250 - 350	82	0.08	0.13	0.18	0.20	0.23	0.25	0.28	0.33	0.38	
	150 - 200	79	0.08	0.10	0.13	0.15	0.18	0.20	0.23	0.25	0.28	
S	High Temp Alloy Hastelloy B, Inconel 600, etc.	200 - 250	67	0.05	0.08	0.10	0.13	0.15	0.18	0.20	0.23	0.25
		140 - 220	37	0.08	0.10	0.13	0.15	0.18	0.20	0.23	0.25	0.28
M	Stainless Steel 300 Series 304, 316, 17-4PH, etc.	220 - 310	27	0.05	0.08	0.08	0.10	0.13	0.15	0.18	0.20	0.23
		135 - 185	61	0.10	0.13	0.15	0.18	0.20	0.23	0.28	0.30	0.33
K	Nodular, Grey, Ductile Cast Iron	185 - 275	43	0.08	0.10	0.10	0.13	0.15	0.18	0.23	0.25	0.28
		120 - 150	168	0.20	0.25	0.30	0.36	0.41	0.46	0.51	0.56	0.61
		150 - 200	152	0.20	0.25	0.30	0.36	0.41	0.46	0.51	0.56	0.61
		200 - 220	145	0.18	0.23	0.28	0.33	0.38	0.43	0.48	0.53	0.58
		220 - 260	131	0.18	0.23	0.28	0.33	0.38	0.43	0.48	0.53	0.58
N	Cast Aluminum	260 - 320	122	0.15	0.20	0.25	0.30	0.36	0.41	0.46	0.51	0.56
		30	457	0.20	0.25	0.33	0.38	0.43	0.51	0.56	0.61	0.66
	Wrought Aluminum	180	305	0.15	0.20	0.28	0.33	0.38	0.46	0.51	0.56	0.61
		30	457	0.20	0.25	0.33	0.38	0.43	0.51	0.56	0.61	0.66
		180	305	0.15	0.20	0.28	0.33	0.38	0.46	0.51	0.56	0.61

Speed and Feed Adjustment

3.5xD	6xD	9xD
See above chart	0.90	0.75

Recommended Speed and Feed Example

If the recommended speed and feed is 91 M/min and 0.25 mm/rev, then reduce to 68 M/min and 0.19 mm/rev when using a 9xD tool	
$91 \cdot 0.75 = 68 \text{ M/min}$	$0.25 \cdot 0.75 = 0.19 \text{ mm/rev}$

Calculations

Value	Formula
mm/min	$\text{RPM} \cdot \text{mm/rev}$
M/min	$\text{RPM} \cdot 0.003 \cdot \text{DIA}$
RPM	$(\text{M/min} \cdot 318.47) / \text{DIA}$

IMPORTANT: The speeds and feeds listed above are a general starting point for all applications. Refer to the Coolant Recommendation charts for coolant requirements to run at the recommended speeds and feeds. Factory technical assistance is available through our Application Engineering department.

A
DRILLING
B
BORING
C
REAMING
D
BURNISHING
E
THREADING
X
SPECIALS

Coolant Recommendations

Imperial (PSI)

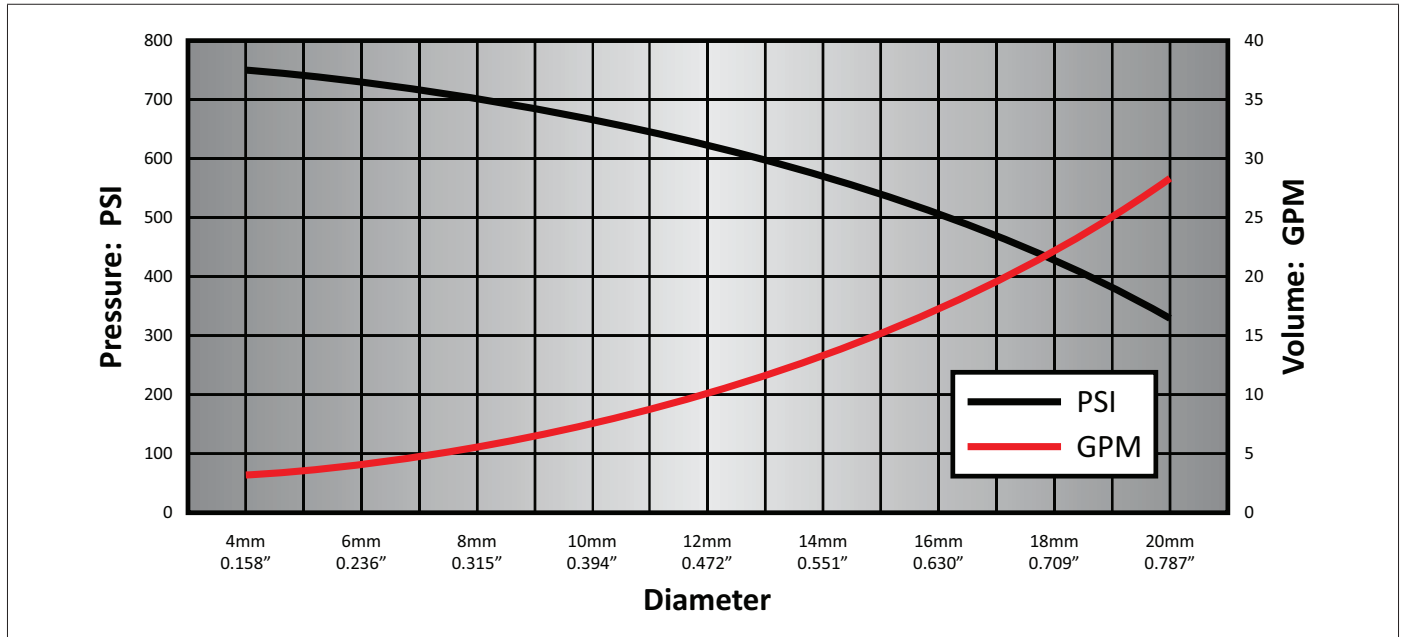

Metric (bar)

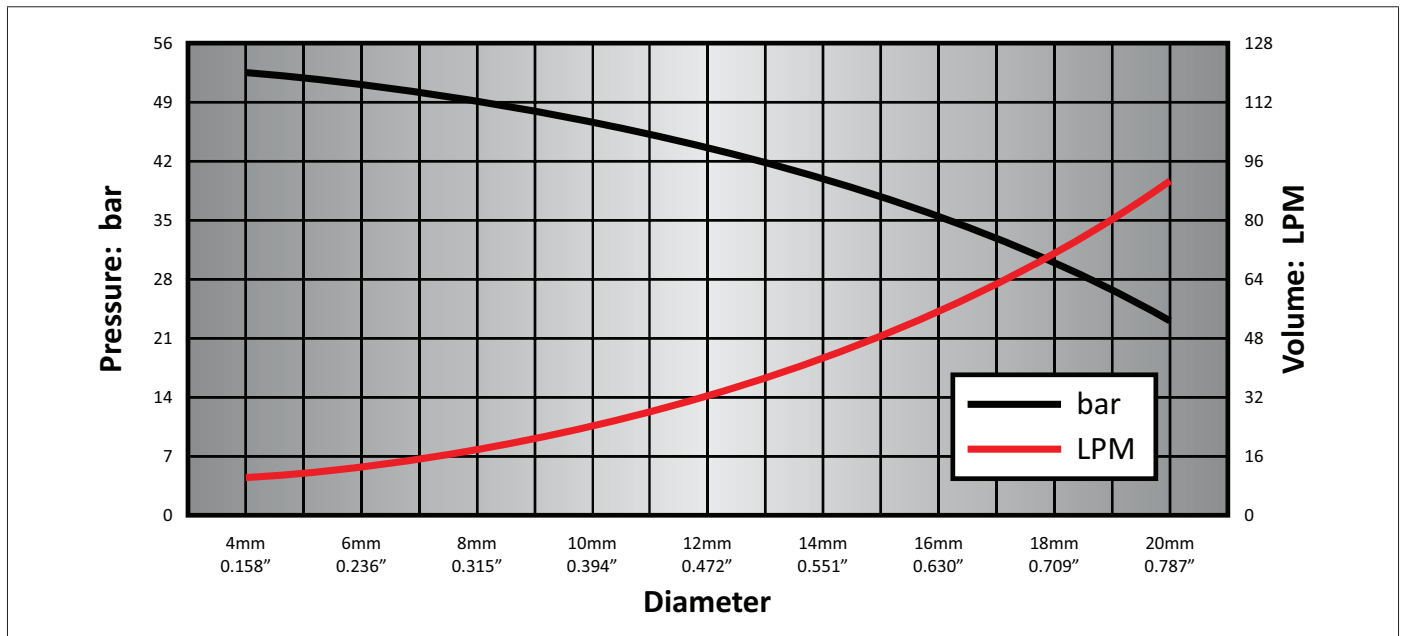

Coolant Adjustment

Drill Length	Pressure and Flow
3.5xD	See above chart
6xD	1.5
9xD	2.0

Coolant Recommendation Example

If the recommended coolant pressure and flow is 600 PSI and 12 GPM for a 3xD tool, the adjusted pressure and flow for a 9xD tool would be:

$600 \cdot 2 = 1200 \text{ PSI}$	$12 \cdot 2 = 24 \text{ GPM}$
----------------------------------	-------------------------------

IMPORTANT: The coolant pressure and flow rate recommendations above represent a good approximation to obtain optimum tool life and chip evacuation at Allied recommended speeds and feeds. If lower coolant capabilities exist in a drilling application, the ASC 320 drilling system will still function at reduced penetration rates. Contact our Application Engineering Department for a more specific recommendation of coolant requirements and/or speeds and feeds.

This page left intentionally blank

A

DRILLING

B

BORING

C

REAMING

D

BURNISHING

E

THREADING

X

SPECIALS

GEN3SYS® XT and XT Pro

High Penetration Replaceable Insert Drilling System | GEN3SYS XT | GEN3SYS XT Pro

▶ Diameter Range: 0.4331" - 1.3780" (11.00mm - 35.00mm)



The Next Generation of Drilling

The GEN3SYS XT and XT Pro replaceable insert high penetration drilling system has been designed to provide high speed production machining beyond the capabilities of the T-A® drilling system. The product offering consists of various grades, geometries, and coatings available to suit the most demanding applications.

Conceived from the outset as the ultimate high performance drilling solution, the GEN3SYS XT drill range is incredibly versatile. Incorporating both straight and helical fluted tool holder options across the range, as well as through coolant for maximum material removal, GEN3SYS XT not only gives outstanding performance from day one, but it can also be reground for extended life and economy.

Excellent chip control	Improves hole quality and surface finish	Provides maximum durability and stability
------------------------	--	---

Applicable Industries

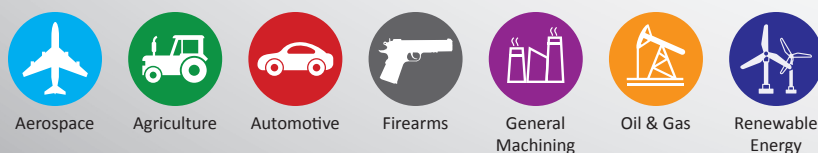

Your safety and the safety of others is very important. This catalog contains important safety messages. Always read and follow all safety precautions.



This triangle is a safety hazard symbol. It alerts you to potential safety hazards that can cause tool failure and serious injury.

When you see this symbol in the catalog, look for a related safety message that may be near this triangle or referred to in the nearby text.

There are safety signal words also used in the catalog. Safety messages follow these words.

WARNING

WARNING (shown above) means that failure to follow the precautions in this message could result in tool failure and serious injury.

NOTICE means that failure to follow the precautions in this message could result in damage to the tool or machine but not result in personal injury.

NOTE and **IMPORTANT** are also used. These are important that you read and follow but are not safety-related.

Visit www.alliedmachine.com for the most up-to-date information and procedures.

GEN3SYS® XT and XT Pro Drilling System Contents

Reference Icons

The following icons will appear throughout the catalog to help you navigate between products.



Setup / Assembly Information

Detailed instructions and information regarding the corresponding part(s)

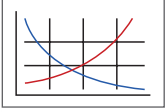

Recommended Cutting Data

Speed and feed recommendations for optimum and safe boring

Series	Diameter Range	
	Imperial (inch)	Metric (mm)
11	0.4331 - 0.4723	11.00 - 11.99
12	0.4724 - 0.5117	12.00 - 12.99
13	0.5118 - 0.5511	13.00 - 13.99
14	0.5512 - 0.5905	14.00 - 14.99
15	0.5906 - 0.6298	15.00 - 15.99
16	0.6299 - 0.6692	16.00 - 16.99
17	0.6693 - 0.7086	17.00 - 17.99
18	0.7087 - 0.7873	18.00 - 19.99
20	0.7874 - 0.8660	20.00 - 21.99
22	0.8661 - 0.9448	22.00 - 23.99
24	0.9449 - 1.0235	24.00 - 25.99
26	1.0236 - 1.1416	26.00 - 28.99
29	1.1417 - 1.2597	29.00 - 31.99
32	1.2598 - 1.3780	32.00 - 35.00

Introduction Information

Why You Should Use the Pro	2 - 3
Test Results and Case Study	4 - 5
GEN3SYS XT Pro Inserts	6
GEN3SYS XT Inserts	7
Insert Comparison and Assembly Details	8
Holder Comparison and Overview	8
Product Nomenclature	10 - 11

Drill Series

11 Series	12 - 15
12 Series	16 - 19
13 Series	20 - 23
14 Series	24 - 27
15 Series	28 - 31
16 Series	32 - 35
17 Series	36 - 39
18 Series	40 - 43
20 Series	44 - 47
22 Series	48 - 51
24 Series	52 - 55
26 Series	56 - 59
29 Series	60 - 63
32 Series	64 - 67

Recommended Cutting Data

Imperial (inch)	[GEN3SYS XT Pro	68 - 71
		GEN3SYS XT	72 - 75
Metric (mm)	[GEN3SYS XT Pro	76 - 79
		GEN3SYS XT	80 - 83
Tap Drill Conversions			84 - 85
Deep Hole Drilling Guidelines			86
Troubleshooting Guide			87

A DRILLING
B BORING
C REAMING
D BURNISHING
E THREADING
X SPECIALS

Why should you GO WITH THE PRO?

GEN3SYS® XT Pro

- ✓ **Up to 40% more tool life**
with the new design for steel applications
- ✓ **Increase your penetration rates**
with the new insert technology
- ✓ **Simplify your tooling selection**
with new specific geometry and coating combinations
- ✓ **Increased heat resistance**
with new AM420 coating on steel inserts
- ✓ **Increased abrasion resistance**
with new AM440 coating on cast iron inserts
- ✓ **Improved chip evacuation**
with enhanced flute design on new XT Pro holders
- ✓ **Increased coolant flow to the cutting zone**
with new coolant configuration on XT Pro holders



INCREASED
penetration rate by
67%

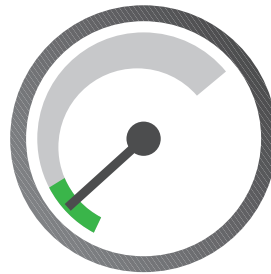

Competitor Insert Penetration Rate



XT Pro Insert Penetration Rate

Project Profile: 7075 Aluminum

Tooling Solution: GEN3SYS XT Pro: N (Non-Ferrous) Geometry

The Problem:

Previously, the customer was using a competitor drill running at the following parameters:

- 30 IPM (762 mm/min)
- Tool life = 15,000" (381 m)

The Solution:

Allied Machine recommended the GEN3SYS XT Pro with N (Non-Ferrous) geometry.

- **Insert** = XTN24-25.00
- The tool ran at the following parameters:
- 50 IPM (1270 mm/min)
- Tool life = 26,000" (660.4 m)



The Advantage:

The GEN3SYS XT Pro increased the penetration rate from 30 IPM to 50 IPM, while drastically increasing the tool life.

Bottom Line: 67% increase in penetration rate | 73% increase in tool life

Project Profile: Forged 8640
Tooling Solution: GEN3SYS XT Pro: P (Steel) Geometry

The Problem:
Previously, the customer was using a competitor drill running at the following parameters:

- 415 SFM (127 M/min)
- 0.009 IPR (0.23 mm/rev)
- The tool drilled a 17.25mm diameter hole to a 20mm depth
- Tool life = **1,000 holes**

The Solution:
Allied Machine recommended the GEN3SYS XT Pro with P (Steel) geometry.

- **Insert** = XTP17-17.25

The tool ran at the following parameters:

- 415 SFM (127 M/min)
- 0.009 IPR (0.23 mm/rev)
- The tool drilled a 17.25mm diameter hole to a 20mm depth
- Tool life = **2,100 holes**

The Advantage:
The GEN3SYS XT Pro increased the tool life from 1,000 holes to 2,100 holes.
Bottom Line: *Doubled the tool life*

The PROOF is in the NUMBERS

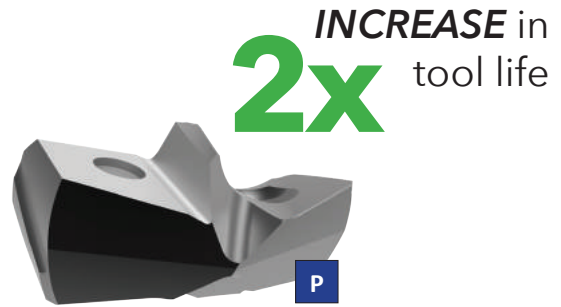
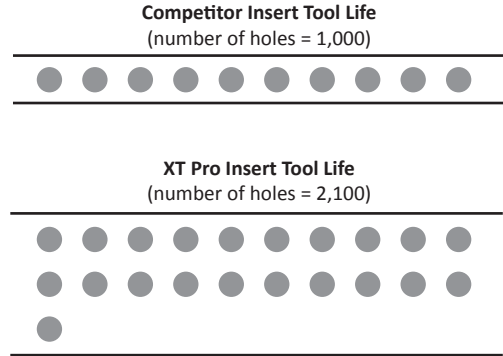

NEW HOLDER DESIGN

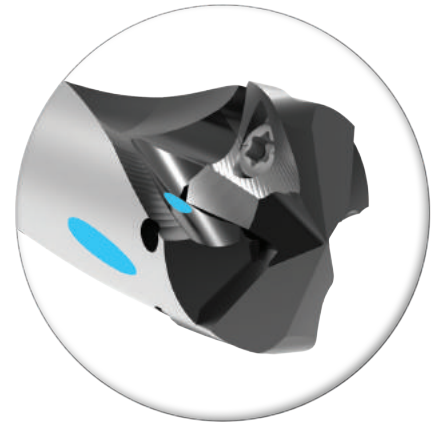

Drill deeper holes

The new XT Pro holders are now available in 10xD.
▶ **This lets you take advantage of the XT Pro insert benefits in deep hole applications.**

Increase your tool life

The new coolant configuration increases coolant flow and directs additional coolant to the cutting zone.
▶ **This increases tool life with all XT Pro inserts.**

That's why you should
GO WITH THE PRO

Competitive Test Results

A
DRILLING
B
BORING
C
REAMING
D
BURNISHING
E
THREADING
X
SPECIALS

TEST RESULTS

Project Profile: Competitive Testing in 4150 Steel
Tooling Solution: GEN3SYS XT Pro: Steel (P) Geometry with XT Pro Holder

The Parameters:

- Hole Diameter = 0.748" (19mm)
- Depth of Cut = 1-1/2" (38.1mm)
- Coolant = 300 PSI
- Speed = 1583 RPM
- Feed = 22.16 inch/min (563 mm/min)

The Results:

When run at the listed parameters, here is how the 3 different tooling solutions performed:

- Competitor 1** = 2478 total linear inches
- Competitor 2** = 3317 total linear inches
- GEN3SYS XT Pro** = 4224 total linear inches

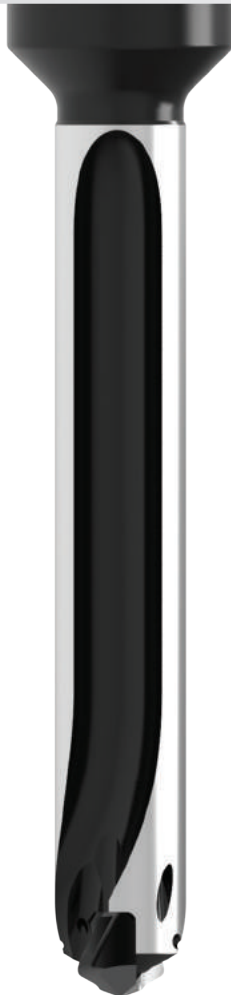

Average Tool Life
 Test Results Drilling in 4150 Steel

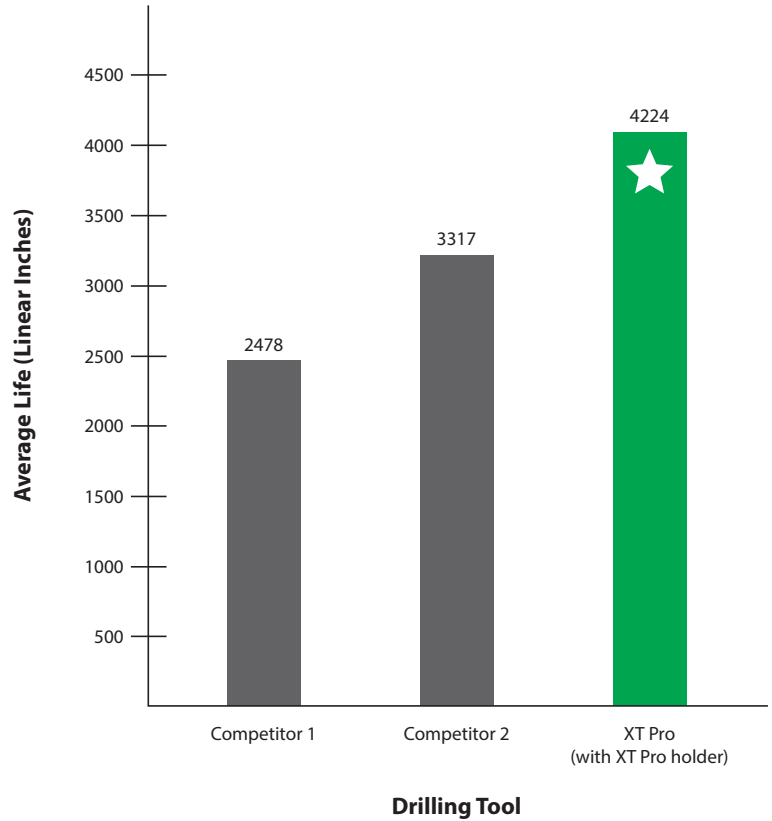

Case Study Example

CASE STUDY

Project Profile: Ductile/Nodular Iron
Tooling Solution: GEN3SYS XT Pro: K (Cast Iron) Geometry

The Problem:
 Previously, the customer was using a competitor drill:
 • Solid carbide drill
 • Tool life = **65 holes**

The Solution:
 Allied Machine recommended the GEN3SYS XT Pro with K (Cast Iron) geometry.
 The tool ran at the following parameters:
 • Hole Diameter = 9/16"
 • Coolant = None
 • Speed = 390 SFM (117 M/min)
 • Feed = 0.008 IPR (0.20 mm/rev)
 • Tool life = **390 holes**

The Advantage:
 The GEN3SYS XT Pro increased the tool life from 65 holes to 390 holes.
Bottom Line: *6x the tool life*

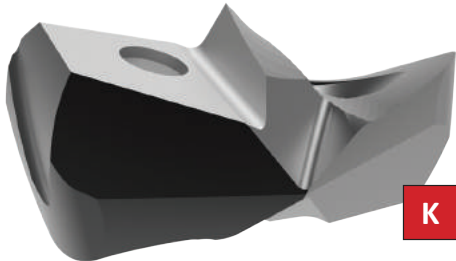

There's More to the Advantage than Tool Life

The XT Pro replaceable tip system provides other benefits in addition to the increase in tool life over the solid carbide drill:

- Because only the insert needs changed when it reaches the end of its life, the XT Pro eliminates the need to re-establish tool lengths, which reduces set-up times.
- Further benefit in set-up is also seen as the tool only needs changed one time for every six of the customer's current method.
- Without the need for regrinds, the customer's stock of tooling is reduced by eliminating the need for float inventory to cover regrind lead time.

The PROOF is in the NUMBERS

Competitor Tool Life
 (number of holes = 65)



XT Pro Tool Life
 (number of holes = 390)

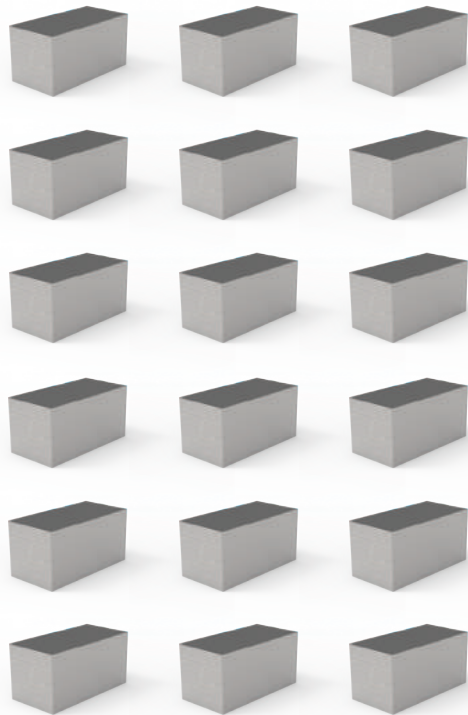

INCREASE in
6x tool life

A
DRILLING
B
BORING
C
REAMING
D
BURNISHING
E
THREADING
X
SPECIALS

GEN3SYS XT Pro Drilling System Information

GEN3SYS XT Pro Drill Inserts

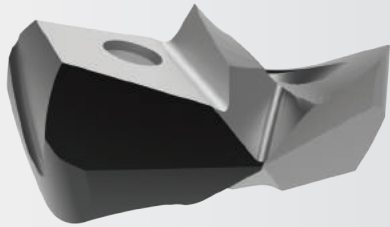

Advanced Design Capabilities

The advanced XT Pro insert combines a coating and geometry specifically designed to achieve optimal results in ISO material drilling applications. With quick connectivity to existing GEN3SYS drill insert holders, the XT Pro insert can be interchanged with previous XT inserts with ease, resulting in minimal set-up times so you can immediately increase your productivity.

XT Pro Inserts Connect with:



XT Pro holders

XT standard holders

P - Steels

- Designed to provide increased penetration rates and tool life in steel applications
- Superior geometry and edge provides excellent chip control
- Allied's multi-layer AM420 coating increases heat resistance and improves tool life

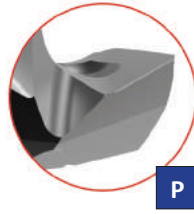

N - Non-ferrous Materials

- Designed for applications in aluminum, brass, and copper
- The geometry yields excellent chip control in these softer materials
- TiN coating gives the versatility to run in a variety of materials while reducing build up

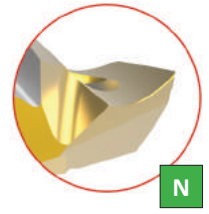

K - Cast Irons

- Uniquely designed for cast/nodular iron applications
- Geometry includes a corner radius for improved hole finish and heat dispersion
- Allied's multi-layer AM440 coating provides increased abrasion resistance and tool life

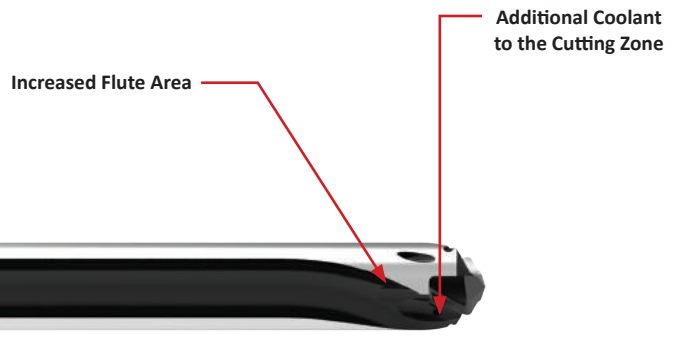
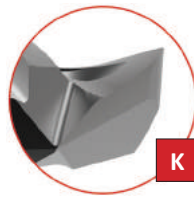

XT Pro Drill Holders

			<p>3xD, 5xD, 7xD, 10xD</p>
<p>Straight flutes</p>	<p>Enhanced coolant inlets improve the coolant flow</p>	<p>Provides increased insert life</p>	<p>Available in 3xD, 5xD, 7xD, and 10xD</p>

GEN3SYS XT Drilling System Information

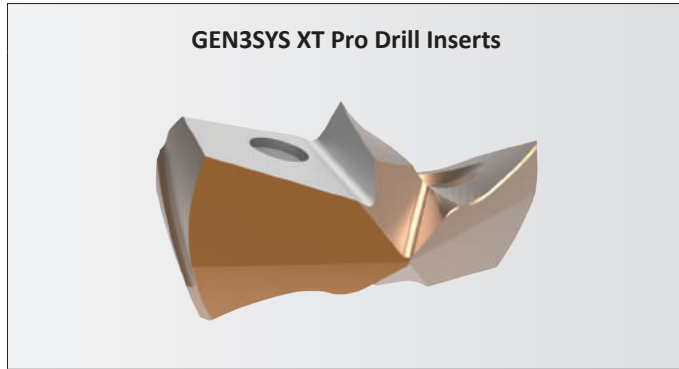

High Penetration Drilling Solutions

The unique geometry of the XT inserts provides excellent chip control. They are designed to increase hole quality, surface finish, and true position when compared to other competitive products. The helical margin design provides maximum durability and stability.

XT Inserts Connect with:

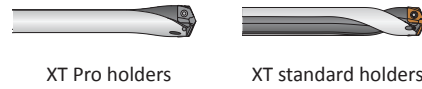

Standard Geometry

- Designed with corner and cutting edge enhancements to deliver more reliability, durability, and productivity
- Increases penetration rates and tool life
- Available in C1 or C2 carbide

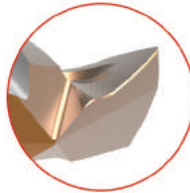

LR - Low Rake Geometry

- The toughest XT geometry available
- Designed for harder steels and less than ideal machining applications
- Available in C1 or C2 carbide

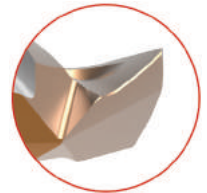

CI - Cast Iron Geometry

- Increases durability and tool life in ductile, nodular, and grey cast irons
- Available in C2 carbide

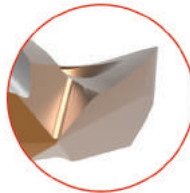

AS - Stainless Steel Geometry

- Designed with a specific geometry to provide unmatched chip control and tool life in austenitic and PH stainless steels, as well as high temperature alloys such as Inconel, Hastelloy, and Titanium alloys
- Available in C2 carbide

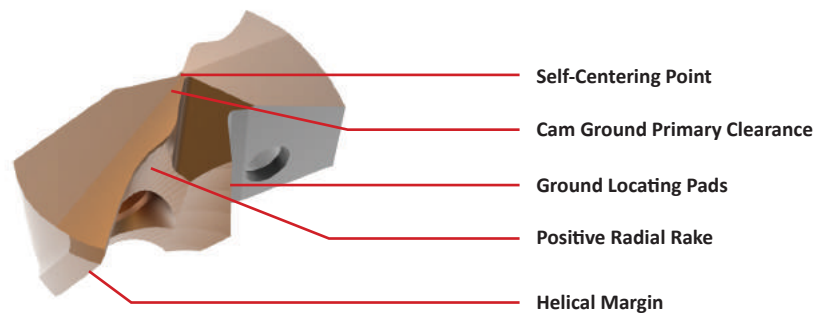
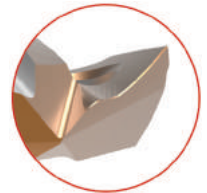





Coating	Features / Benefits
AM300®	<ul style="list-style-type: none"> • Increased heat resistance over AM200® coating • Up to 20% increased tool life over AM200 coating • Provides superior tool life at high penetration rates

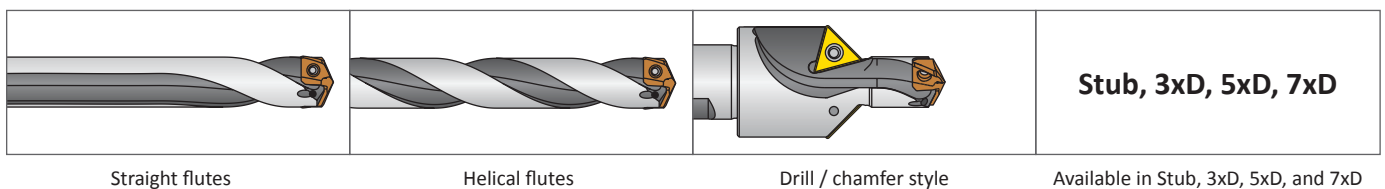

XT Drill Standard Holders

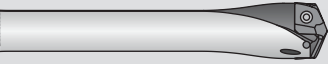

Insert Comparison and Assembly Information

		XT Pro Inserts	XT Inserts
B	Recommended for increased productivity		<input checked="" type="checkbox"/>
	ISO specific geometry/coating combination		<input checked="" type="checkbox"/>
C	Connects with XT Pro holders		<input checked="" type="checkbox"/>
	Connects with XT holders		<input checked="" type="checkbox"/>



Step 1:
Align the flats on the GEN3SYS XT insert with the flats on the ears of the holder.

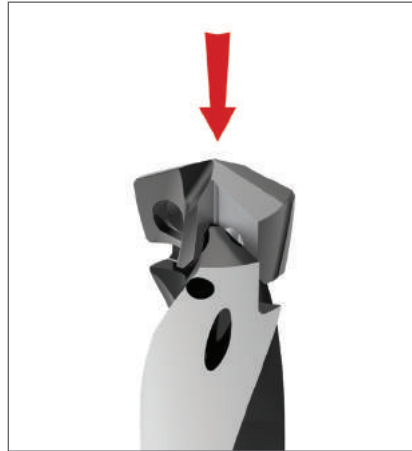



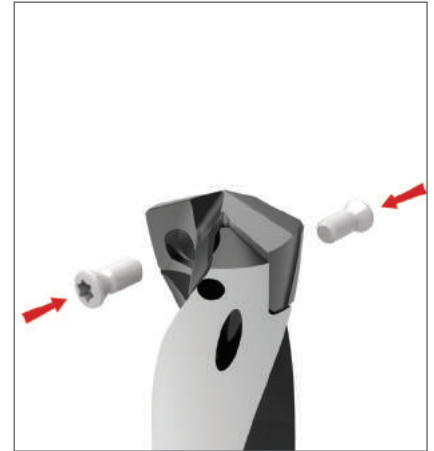

Step 2:
Slide the insert into the precision ground locating pocket on the holder. The insert should not be turned, rotated, or twisted for locking purposes. The holder pocket and locating pads on the insert assure optimum fit and repeatability.



Step 3:
Apply a generous amount of E-Z Break® (provided in the packaging) onto the supplied TORX® Plus screws.

Tighten the TORX Plus screws to the recommended torque value specified in the catalog by series. A preset torx driver is available to assure that the proper torque is applied.

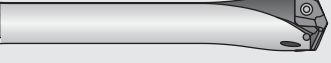
Holder Comparison and Overview

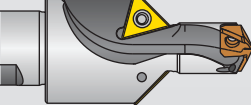
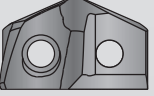
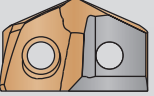
		 XT Pro Holders	 XT Standard Holders
Recommended for increased productivity		<input checked="" type="checkbox"/>	
Straight flute		<input checked="" type="checkbox"/>	<input checked="" type="checkbox"/>
Helical flute			<input checked="" type="checkbox"/>
Drill/chamfer option			<input checked="" type="checkbox"/>
Available in 10xD length	10XD	<input checked="" type="checkbox"/>	
Connects with XT Pro inserts		<input checked="" type="checkbox"/>	<input checked="" type="checkbox"/>
Connects with XT inserts		<input checked="" type="checkbox"/>	<input checked="" type="checkbox"/>

XT Pro Holders



Straight Flute

XT Holders



Straight Flute



Helical Flute



Drill/Chamfer

Product Nomenclature

GEN3SYS XT Pro Drill Inserts

XT	P	11	–	11.00
1	2	3		4

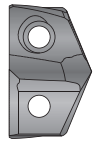

1. XT Pro Drill Insert	2. ISO Material / Geometry	3. Series	4. Diameter (mm)														
XT = XT Pro insert	P = Steel K = Cast iron N = Non-ferrous	<table border="0"> <tr> <td>11 = 11 series</td> <td>18 = 18 series</td> </tr> <tr> <td>12 = 12 series</td> <td>20 = 20 series</td> </tr> <tr> <td>13 = 13 series</td> <td>22 = 22 series</td> </tr> <tr> <td>14 = 14 series</td> <td>24 = 24 series</td> </tr> <tr> <td>15 = 15 series</td> <td>26 = 26 series</td> </tr> <tr> <td>16 = 16 series</td> <td>29 = 29 series</td> </tr> <tr> <td>17 = 17 series</td> <td>32 = 32 series</td> </tr> </table>	11 = 11 series	18 = 18 series	12 = 12 series	20 = 20 series	13 = 13 series	22 = 22 series	14 = 14 series	24 = 24 series	15 = 15 series	26 = 26 series	16 = 16 series	29 = 29 series	17 = 17 series	32 = 32 series	For complete list of diameter ranges by series, see contents page.
11 = 11 series	18 = 18 series																
12 = 12 series	20 = 20 series																
13 = 13 series	22 = 22 series																
14 = 14 series	24 = 24 series																
15 = 15 series	26 = 26 series																
16 = 16 series	29 = 29 series																
17 = 17 series	32 = 32 series																

GEN3SYS XT Drill Inserts

7	C2	12	P	–	.484	CI
1	2	3	4		5	6

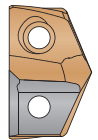

1. XT Drill Insert	2. Insert Material	3. Series	4. Coating														
7 = XT insert	C1 = C1 (K35) carbide C2 = C2 (K20) carbide	<table border="0"> <tr> <td>11 = 11 series</td> <td>18 = 18 series</td> </tr> <tr> <td>12 = 12 series</td> <td>20 = 20 series</td> </tr> <tr> <td>13 = 13 series</td> <td>22 = 22 series</td> </tr> <tr> <td>14 = 14 series</td> <td>24 = 24 series</td> </tr> <tr> <td>15 = 15 series</td> <td>26 = 26 series</td> </tr> <tr> <td>16 = 16 series</td> <td>29 = 29 series</td> </tr> <tr> <td>17 = 17 series</td> <td>32 = 32 series</td> </tr> </table>	11 = 11 series	18 = 18 series	12 = 12 series	20 = 20 series	13 = 13 series	22 = 22 series	14 = 14 series	24 = 24 series	15 = 15 series	26 = 26 series	16 = 16 series	29 = 29 series	17 = 17 series	32 = 32 series	P = AM300®
11 = 11 series	18 = 18 series																
12 = 12 series	20 = 20 series																
13 = 13 series	22 = 22 series																
14 = 14 series	24 = 24 series																
15 = 15 series	26 = 26 series																
16 = 16 series	29 = 29 series																
17 = 17 series	32 = 32 series																

5. Diameter	6. Geometry
0017 = Inch .515 = Decimal 13 = Metric	CI = Cast iron LR = Low rake AS = Stainless steel

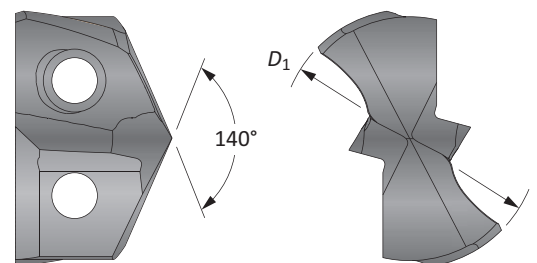

Regrinding and Recoating

The GEN3SYS XT and XT Pro drilling system is so cost efficient that it eliminates the need for regrinding and recoating. However, if you choose to have your drill inserts reground, it is critical that it be done by Allied Machine. Any slight deviation in performance due to an improperly reground drill insert will more than offset any benefit from regrinding. Using our service ensures that the best tool performance is maintained in your production process. When returning tools for regrinding, please package tools carefully to avoid damage during shipment. Returning drill inserts for regrinding in their original packaging will help avoid damage during shipment. Drill inserts reground by Allied Machine are repackaged and clearly identified as "Allied Regrind" to avoid any confusion with new tools.

Reference Key

Symbol	Attribute
D_1	Insert diameter

Product Nomenclature

GEN3SYS XT and XT Pro Drill Holders

HXT	03	12	S	-	20	FM
1	2	3	4		5	6



1. Holder 6 = XT standard holder HXT = XT Pro holder	2. Length 01 = Stub Length (standard only) 03 = 3x Diameter 05 = 5x Diameter 07 = 7x Diameter 10 = 10x Diameter (Pro only)	3. Series 11 = 11 series 18 = 18 series 12 = 12 series 20 = 20 series 13 = 13 series 22 = 22 series 14 = 14 series 24 = 24 series 15 = 15 series 26 = 26 series 16 = 16 series 29 = 29 series 17 = 17 series 32 = 32 series	4. Flute S = Straight H = Helical C45 = Drill/Chamfer (both helical and drill/chamfer options available for XT standard only)										
5. Shank Diameter <table border="1"> <thead> <tr> <th>Imperial (inch)</th> <th>Metric (mm)</th> </tr> </thead> <tbody> <tr> <td>063 = 5/8"</td> <td>16 = 16mm</td> </tr> <tr> <td>075 = 3/4"</td> <td>20 = 20mm</td> </tr> <tr> <td>100 = 1"</td> <td>25 = 25mm</td> </tr> <tr> <td>125 = 1-1/4"</td> <td>32 = 32mm</td> </tr> <tr> <td>150 = 1-1/2"</td> <td>40 = 40mm</td> </tr> </tbody> </table>	Imperial (inch)	Metric (mm)	063 = 5/8"	16 = 16mm	075 = 3/4"	20 = 20mm	100 = 1"	25 = 25mm	125 = 1-1/4"	32 = 32mm	150 = 1-1/2"	40 = 40mm	6. Shank Style F = Flanged with flat FM = Flanged metric with flat C = Cylindrical (no flat) CM = Cylindrical metric (no flat)
Imperial (inch)	Metric (mm)												
063 = 5/8"	16 = 16mm												
075 = 3/4"	20 = 20mm												
100 = 1"	25 = 25mm												
125 = 1-1/4"	32 = 32mm												
150 = 1-1/2"	40 = 40mm												

Holder Ordering Information

The series designator (11 series, 12 series, etc.) in the top corner of each page is for your reference when ordering. Please refer to these series designators when placing an order. For example, a 12 series drill insert only fits into a 12 series holder.

Reference Key

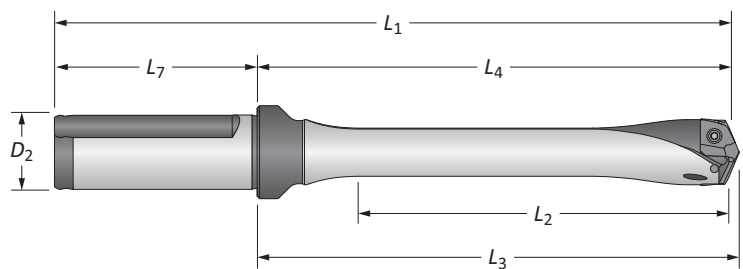

Symbol	Attribute
D_2	Shank diameter
D_5	Step diameter (drill/chamfer)
L_1	Overall length
L_2	Drill depth
L_3	Holder reference length
L_4	Holder body length
L_5	Step length (drill/chamfer)
L_7	Shank length
P_1	Rear pipe tap (XT standard)

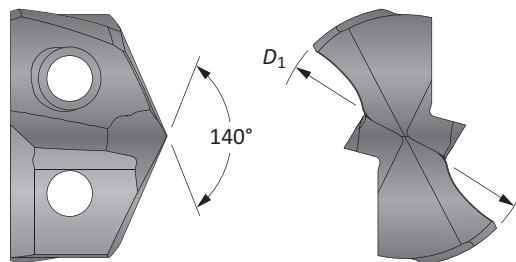
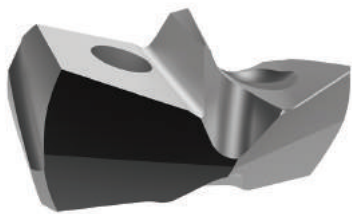

GEN3SYS XT Pro Drill Inserts

11 Series | Diameter Range: 0.4331" - 0.4723" (11.00mm - 11.99mm)



Fractional Equivalent	Insert				
	D_1 inch	D_1 mm	Part No. P	Part No. K	Part No. N
-	0.4331	11.00	XTP11-11.00	XTK11-11.00	XTN11-11.00
7/16	0.4375	11.11	XTP11-11.11	XTK11-11.11	XTN11-11.11
-	0.4409	11.20	XTP11-11.20	XTK11-11.20	XTN11-11.20
-	0.4449	11.30	XTP11-11.30	XTK11-11.30	XTN11-11.30
-	0.4488	11.40	XTP11-11.40	XTK11-11.40	XTN11-11.40
-	0.4528	11.50	XTP11-11.50	XTK11-11.50	XTN11-11.50
29/64	0.4531	11.51	XTP11-11.51	XTK11-11.51	XTN11-11.51
-	0.4567	11.60	XTP11-11.60	XTK11-11.60	XTN11-11.60
-	0.4606	11.70	XTP11-11.70	XTK11-11.70	XTN11-11.70
-	0.4646	11.80	XTP11-11.80	XTK11-11.80	XTN11-11.80
15/32	0.4688	11.91	XTP11-11.91	XTK11-11.91	XTN11-11.91

Inserts sold in multiples of 1

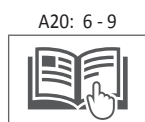
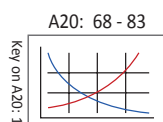

Sizes not shown are available upon request. When ordering, please follow the example below:	
Imperial:	0.5180", Steel, 13 series = use Part No. XTP13-13.16
Metric:	13.16mm, Steel, 13 series = use Part No. XTP13-13.16

GEN3SYS XT Pro Drill Insert Holders

11 Series | Diameter Range: 0.4331" - 0.4723" (11.00mm - 11.99mm)

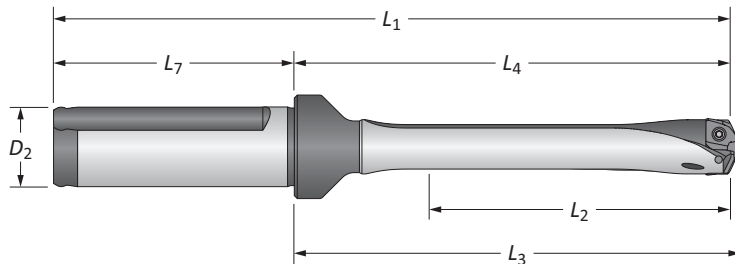

Flute	Body					Shank			Part No.
	Length	L ₂	L ₄	L ₃	L ₁	L ₇	D ₂	Flat	
i Straight 	3xD	1-27/64	2-29/64	2-17/32	4-21/64	1-7/8	5/8	YES	HXT0311S-063F
	3xD	1-27/64	2-29/64	2-17/32	4-21/64	1-7/8	5/8	NO	HXT0311S-063C
	5xD	2-23/64	3-13/32	3-31/64	5-9/32	1-7/8	5/8	YES	HXT0511S-063F
	5xD	2-23/64	3-13/32	3-31/64	5-9/32	1-7/8	5/8	NO	HXT0511S-063C
	7xD	3-19/64	4-11/32	4-27/64	6-7/32	1-7/8	5/8	YES	HXT0711S-063F
	7xD	3-19/64	4-11/32	4-27/64	6-7/32	1-7/8	5/8	NO	HXT0711S-063C
	10xD	4-23/32	5-49/64	5-27/32	7-41/64	1-7/8	5/8	YES	HXT1011S-063F
10xD	4-23/32	5-49/64	5-27/32	7-41/64	1-7/8	5/8	NO	HXT1011S-063C	
iii Straight 	3xD	36.0	62.6	64.4	110.6	48.0	16.0	YES	HXT0311S-16FM
	3xD	36.0	62.6	64.4	110.6	48.0	16.0	NO	HXT0311S-16CM
	5xD	60.0	86.6	88.4	134.6	48.0	16.0	YES	HXT0511S-16FM
	5xD	60.0	86.6	88.4	134.6	48.0	16.0	NO	HXT0511S-16CM
	7xD	83.7	110.6	112.4	158.6	48.0	16.0	YES	HXT0711S-16FM
	7xD	83.7	110.6	112.4	158.6	48.0	16.0	NO	HXT0711S-16CM
	10xD	119.9	146.6	148.4	194.6	48.0	16.0	YES	HXT1011S-16FM
	10xD	119.9	146.6	148.4	194.6	48.0	16.0	NO	HXT1011S-16CM

Connection Accessories

				Admissible Tightening Torque*
71843-IP6-1	8IP-6	8IP-6TL	8IP-6B	4.4 in-lbs (50 N-cm)

*Tightening torques are calculated with a friction coefficient of $\mu = 0.14$ and develop 90% of ultimate yield strength

⚠ WARNING Refer to Speed and Feed charts for recommended adjustments to speeds and feeds. Refer to page A20: 86 for deep hole drilling guidelines in this section of the catalog. Visit www.alliedmachine.com/DeepHoleGuidelines for the most up-to-date information and procedures. Factory technical assistance is available for your specific applications through our Application Engineering Team.

i = Imperial (in)
iii = Metric (mm)

Screws sold in multiples of 10



GEN3SYS XT Drill Inserts

11 Series | Diameter Range: 0.4331" - 0.4723" (11.00mm - 11.99mm)

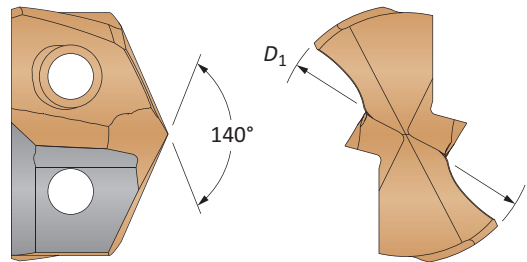
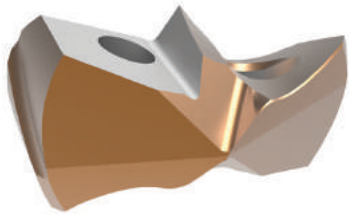

Carbide Substrate	Insert			Standard Part No.	Low Rake Part No.	Cast Iron Part No.	Stainless Part No.
	Fractional Equivalent	D_1 inch	D_1 mm				
C1 (K35)	-	0.4331	11.00	7C111P-11	7C111P-11LR	-	-
	7/16	0.4375	11.11	7C111P-0014	7C111P-0014LR	-	-
	-	0.4528	11.50	7C111P-11.5	7C111P-11.5LR	-	-
	29/64	0.4531	11.51	7C111P-.453	7C111P-.453LR	-	-
	15/32	0.4688	11.91	7C111P-0015	7C111P-0015LR	-	-
C2 (K20)	-	0.4331	11.00	7C211P-11	7C211P-11LR	7C211P-11CI	7C211P-11AS
	7/16	0.4375	11.11	7C211P-0014	7C211P-0014LR	7C211P-0014CI	7C211P-0014AS
	-	0.4528	11.50	7C211P-11.5	7C211P-11.5LR	7C211P-11.5CI	7C211P-11.5AS
	29/64	0.4531	11.51	7C211P-.453	7C211P-.453LR	7C211P-.453CI	7C211P-.453AS
	15/32	0.4688	11.91	7C211P-0015	7C211P-0015LR	7C211P-0015CI	7C211P-0015AS

Inserts sold in multiples of 1

A20: 68 - 83

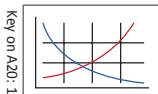

A20: 6 - 9



Sizes not shown are available upon request.
When ordering, please follow the example below:



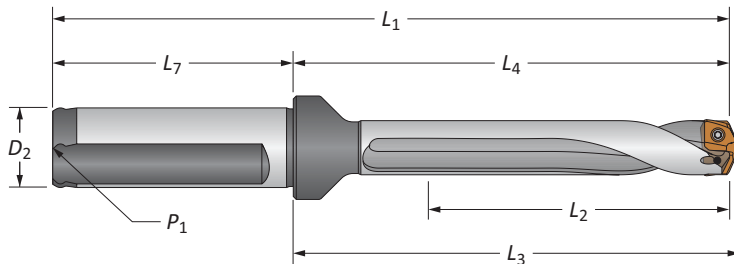

Imperial:	0.5200", 13 series, C2 = use Part No. 7C213P-.5200
Metric:	13.20mm, 13 series, C2 = use Part No. 7C213P-13.20

GEN3SYS XT Standard Drill Insert Holders

11 Series | Diameter Range: 0.4331" - 0.4723" (11.00mm - 11.99mm)



Straight and Helical

Flute	Length	Body				Shank				Part No.	
		L ₂	L ₄	L ₃	L ₁	L ₇	D ₂	P ₁	Flat		
 Straight	3xD	1-27/64	2-29/64	2-17/32	4-21/64	1-7/8	5/8	1/16	YES	60311S-063F	
	5xD	2-23/64	3-13/32	3-31/64	5-9/32	1-7/8	5/8	1/16	YES	60511S-063F	
	7xD	3-19/64	4-11/32	4-27/64	6-7/32	1-7/8	5/8	1/16	YES	60711S-063F	
 Helical	Stub	5/8	1-43/64	1-3/4	3-35/64	1-7/8	5/8	1/16	YES	60111H-063F	
	3xD	1-27/64	2-29/64	2-17/32	4-21/64	1-7/8	5/8	1/16	YES	60311H-063F	
	3xD	1-27/64	2-29/64	2-17/32	4-21/64	1-7/8	5/8	1/16	NO	60311H-063C	
	5xD	2-23/64	3-13/32	3-31/64	5-9/32	1-7/8	5/8	1/16	YES	60511H-063F	
	5xD	2-23/64	3-13/32	3-31/64	5-9/32	1-7/8	5/8	1/16	NO	60511H-063C	
	7xD	3-19/64	4-11/32	4-27/64	6-7/32	1-7/8	5/8	1/16	YES	60711H-063F	
	7xD	3-19/64	4-11/32	4-27/64	6-7/32	1-7/8	5/8	1/16	NO	60711H-063C	
 Straight	3xD	36.0	62.6	64.4	110.6	48.0	16.0	1/16*	YES	60311S-16FM	
	5xD	60.0	86.6	88.4	134.6	48.0	16.0	1/16*	YES	60511S-16FM	
	7xD	83.7	110.6	112.4	158.6	48.0	16.0	1/16*	YES	60711S-16FM	
	Stub	16.0	42.6	44.7	90.6	48.0	16.0	1/16*	YES	60111H-16FM	
	 Helical	3xD	36.0	62.6	64.4	110.6	48.0	16.0	1/16*	YES	60311H-16FM
		3xD	36.0	62.6	64.4	110.6	48.0	16.0	1/16*	NO	60311H-16CM
		5xD	60.0	86.6	88.4	134.6	48.0	16.0	1/16*	YES	60511H-16FM
		5xD	60.0	86.6	88.4	134.6	48.0	16.0	1/16*	NO	60511H-16CM
		7xD	83.7	110.6	112.4	158.6	48.0	16.0	1/16*	YES	60711H-16FM
		7xD	83.7	110.6	112.4	158.6	48.0	16.0	1/16*	NO	60711H-16CM

*Thread to BSP and ISO 7-1

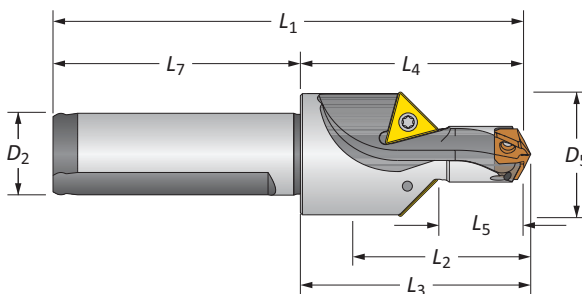

Drill / Chamfer

	Step		Body				Shank		Part No.	 Chamfer Insert
	D ₅	L ₅	L ₂	L ₄	L ₃	L ₁	L ₇	D ₂		
i	61/64	21/32	15/16	1-43/64	1-3/4	3-35/64	1-7/8	5/8	60111C45-063F	TCMT-110204
m	24.1	16.5	23.8	42.2	44.3	90.2	48.0	16.0	60111C45-16FM	TCMT-110204

Connection Accessories

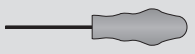
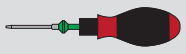
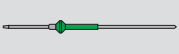
 Insert Screws	 Insert Driver	 Preset Torque Hand Driver	 Replacement Tips	Admissible Tightening Torque*
71843-IP6-1	8IP-6	8IP-6TL	8IP-6B	

*Tightening torques are calculated with a friction coefficient of $\mu = 0.14$ and develop 90% of ultimate yield strength

Chamfer inserts sold separately in multiples of 10 | Screws sold in multiples of 10



i = Imperial (in)
m = Metric (mm)

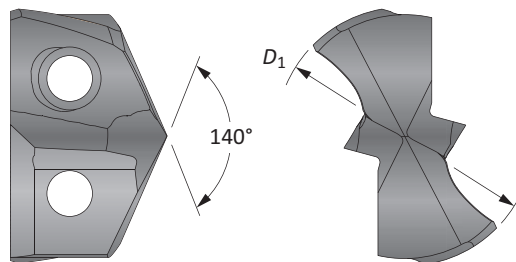
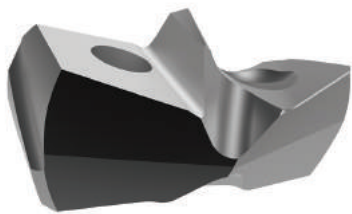

GEN3SYS XT Pro Drill Inserts

12 Series | Diameter Range: 0.4724" - 0.5117" (12.00mm - 12.99mm)



Fractional Equivalent	Insert				
	D_1 inch	D_1 mm	Part No. P	Part No. K	Part No. N
-	0.4724	12.00	XTP12-12.00	XTK12-12.00	XTN12-12.00
-	0.4764	12.10	XTP12-12.10	XTK12-12.10	XTN12-12.10
-	0.4803	12.20	XTP12-12.20	XTK12-12.20	XTN12-12.20
31/64	0.4844	12.30	XTP12-12.30	XTK12-12.30	XTN12-12.30
-	0.4882	12.40	XTP12-12.40	XTK12-12.40	XTN12-12.40
-	0.4921	12.50	XTP12-12.50	XTK12-12.50	XTN12-12.50
-	0.4961	12.60	XTP12-12.60	XTK12-12.60	XTN12-12.60
1/2	0.5000	12.70	XTP12-12.70	XTK12-12.70	XTN12-12.70
-	0.5039	12.80	XTP12-12.80	XTK12-12.80	XTN12-12.80
-	0.5079	12.90	XTP12-12.90	XTK12-12.90	XTN12-12.90

Inserts sold in multiples of 1

A20: 68 - 83

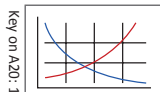

Key on A20: 1

A20: 6 - 9



Sizes not shown are available upon request.
When ordering, please follow the example below:

Imperial:	0.5180", Steel, 13 series = use Part No. XTP13-13.16
Metric:	13.16mm, Steel, 13 series = use Part No. XTP13-13.16



GEN3SYS XT Pro Drill Insert Holders

12 Series | Diameter Range: 0.4724" - 0.5117" (12.00mm - 12.99mm)

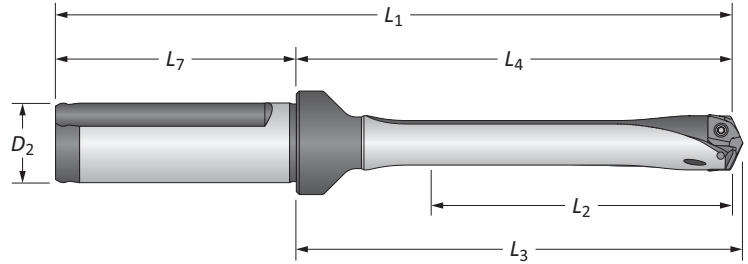

Flute	Body					Shank			Part No.
	Length	L ₂	L ₄	L ₃	L ₁	L ₇	D ₂	Flat	
i Straight	3xD	1-17/32	2-5/8	2-45/64	4-21/32	2-1/32	3/4	YES	HXT0312S-075F
	3xD	1-17/32	2-5/8	2-45/64	4-21/32	2-1/32	3/4	NO	HXT0312S-075C
	5xD	2-9/16	3-41/64	3-47/64	5-43/64	2-1/32	3/4	YES	HXT0512S-075F
	5xD	2-9/16	3-41/64	3-47/64	5-43/64	2-1/32	3/4	NO	HXT0512S-075C
	7xD	3-37/64	4-21/32	4-3/4	6-11/16	2-1/32	3/4	YES	HXT0712S-075F
	7xD	3-37/64	4-21/32	4-3/4	6-11/16	2-1/32	3/4	NO	HXT0712S-075C
	10xD	5-7/64	6-13/64	6-9/32	8-15/64	2-1/32	3/4	YES	⚠ HXT1012S-075F
	10xD	5-7/64	6-13/64	6-9/32	8-15/64	2-1/32	3/4	NO	⚠ HXT1012S-075C
m Straight	3xD	39.0	66.6	68.7	116.6	50.0	20.0	YES	HXT0312S-20FM
	3xD	39.0	66.6	68.7	116.6	50.0	20.0	NO	HXT0312S-20CM
	5xD	65.0	92.5	94.7	142.5	50.0	20.0	YES	HXT0512S-20FM
	5xD	65.0	92.5	94.7	142.5	50.0	20.0	NO	HXT0512S-20CM
	7xD	90.9	118.3	120.7	168.3	50.0	20.0	YES	HXT0712S-20FM
	7xD	90.9	118.3	120.7	168.3	50.0	20.0	NO	HXT0712S-20CM
	10xD	129.9	157.5	159.7	207.5	50.0	20.0	YES	⚠ HXT1012S-20FM
	10xD	129.9	157.5	159.7	207.5	50.0	20.0	NO	⚠ HXT1012S-20CM

Connection Accessories

					Admissible Tightening Torque*
7247-IP7-1	7247N-IP7-1	8IP-7	8IP-7TL	8IP-7B	7.4 in-lbs (84 N-cm)

*Tightening torques are calculated with a friction coefficient of $\mu = 0.14$ and develop 90% of ultimate yield strength

⚠ WARNING Refer to Speed and Feed charts for recommended adjustments to speeds and feeds. Refer to page A20: 86 for deep hole drilling guidelines in this section of the catalog. Visit www.alliedmachine.com/DeepHoleGuidelines for the most up-to-date information and procedures. Factory technical assistance is available for your specific applications through our Application Engineering Team.

i = Imperial (in)
m = Metric (mm)

Screws sold in multiples of 10

A DRILLING
B BORING
C REAMING
D BURNISHING
E THREADING
X SPECIALS

GEN3SYS XT Drill Inserts

12 Series | Diameter Range: 0.4724" - 0.5117" (12.00mm - 12.99mm)

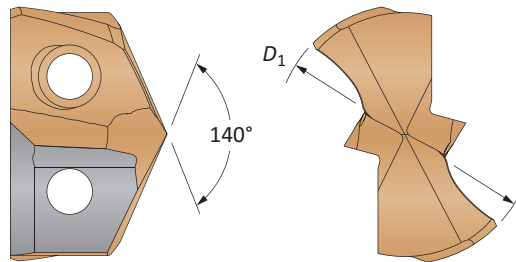
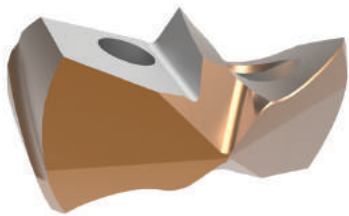

Carbide Substrate	Insert			Standard Part No.	Low Rake Part No.	Cast Iron Part No.	Stainless Part No.
	Fractional Equivalent	D_1 inch	D_1 mm				
C1 (K35)	-	0.4724	12.00	7C112P-12	7C112P-12LR	-	-
	31/64	0.4844	12.30	7C112P-.484	7C112P-.484LR	-	-
	-	0.4921	12.50	7C112P-12.5	7C112P-12.5LR	-	-
	1/2	0.5000	12.70	7C112P-0016	7C112P-0016LR	-	-
C2 (K20)	-	0.4724	12.00	7C212P-12	7C212P-12LR	7C212P-12CI	7C212P-12AS
	31/64	0.4844	12.30	7C212P-.484	7C212P-.484LR	7C212P-.484CI	7C212P-.484AS
	-	0.4921	12.50	7C212P-12.5	7C212P-12.5LR	7C212P-12.5CI	7C212P-12.5AS
	1/2	0.5000	12.70	7C212P-0016	7C212P-0016LR	7C212P-0016CI	7C212P-0016AS

Inserts sold in multiples of 1

A20: 68 - 83

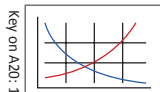

A20: 6 - 9



Sizes not shown are available upon request.
When ordering, please follow the example below:



Imperial:	0.5200", 13 series, C2 = use Part No. 7C213P-.5200
Metric:	13.20mm, 13 series, C2 = use Part No. 7C213P-13.20

GEN3SYS XT Standard Drill Insert Holders

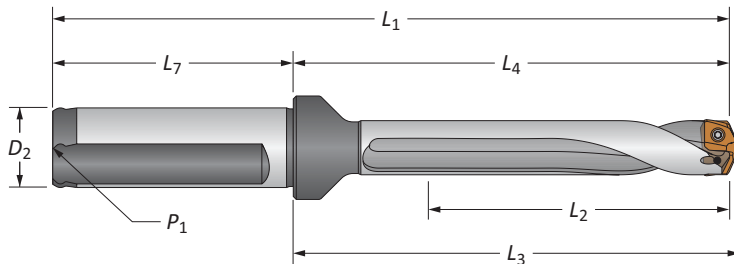
12 Series | Diameter Range: 0.4724" - 0.5117" (12.00mm - 12.99mm)



Straight and Helical

Flute	Length	Body				Shank				Flat	Part No.
		L ₂	L ₄	L ₃	L ₁	L ₇	D ₂	P ₁			
	3xD	1-17/32	2-5/8	2-45/64	4-21/32	2-1/32	3/4	1/8	YES	60312S-075F	
	5xD	2-9/16	3-41/64	3-47/64	5-43/64	2-1/32	3/4	1/8	YES	60512S-075F	
	7xD	3-37/64	4-21/32	4-3/4	6-11/16	2-1/32	3/4	1/8	YES	60712S-075F	
	Stub	5/8	1-45/64	1-25/32	3-47/64	2-1/32	3/4	1/8	YES	60112H-075F	
	3xD	1-17/32	2-5/8	2-45/64	4-21/32	2-1/32	3/4	1/8	YES	60312H-075F	
	3xD	1-17/32	2-5/8	2-45/64	4-21/32	2-1/32	3/4	1/8	NO	60312H-075C	
	5xD	2-9/16	3-41/64	3-47/64	5-43/64	2-1/32	3/4	1/8	YES	60512H-075F	
	5xD	2-9/16	3-41/64	3-47/64	5-43/64	2-1/32	3/4	1/8	NO	60512H-075C	
	7xD	3-37/64	4-21/32	4-3/4	6-11/16	2-1/32	3/4	1/8	YES	60712H-075F	
	7xD	3-37/64	4-21/32	4-3/4	6-11/16	2-1/32	3/4	1/8	NO	60712H-075C	
	3xD	39.0	66.6	68.7	116.6	50.0	20.0	1/8*	YES	60312S-20FM	
	5xD	65.0	92.5	94.7	142.5	50.0	20.0	1/8*	YES	60512S-20FM	
	7xD	90.9	118.3	120.7	168.3	50.0	20.0	1/8*	YES	60712S-20FM	
	Stub	16.0	43.2	45.4	93.2	50.0	20.0	1/8*	YES	60112H-20FM	
	3xD	39.0	66.6	68.7	116.6	50.0	20.0	1/8*	YES	60312H-20FM	
	3xD	39.0	66.6	68.7	116.6	50.0	20.0	1/8*	NO	60312H-20CM	
	5xD	65.0	92.5	94.7	142.5	50.0	20.0	1/8*	YES	60512H-20FM	
	5xD	65.0	92.5	94.7	142.5	50.0	20.0	1/8*	NO	60512H-20CM	
	7xD	90.9	118.3	120.7	168.3	50.0	20.0	1/8*	YES	60712H-20FM	
	7xD	90.9	118.3	120.7	168.3	50.0	20.0	1/8*	NO	60712H-20CM	

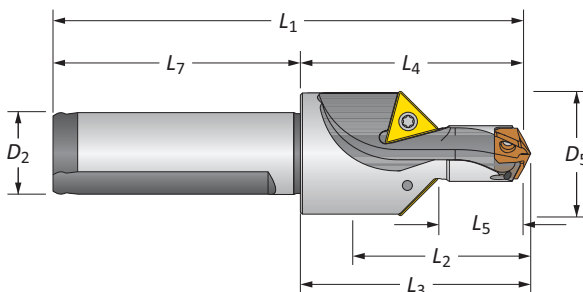
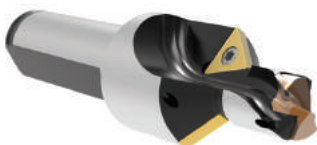

*Thread to BSP and ISO 7-1



Drill / Chamfer

	Step		Body				Shank		Part No.	 Chamfer Insert
	D ₅	L ₅	L ₂	L ₄	L ₃	L ₁	L ₇	D ₂		
i	31/32	45/64	63/64	1-45/64	1-25/32	3-47/64	2-1/32	3/4	60112C45-075F	TCMT-110204
m	24.8	18.0	35.2	43.2	45.4	93.2	50.0	20.0	60112C45-20FM	TCMT-110204

Connection Accessories

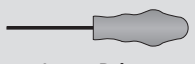
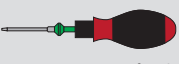
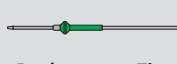
 Insert Screws	 Nylon Locking Screws	 Insert Driver	 Preset Torque Hand Driver	 Replacement Tips	Admissible Tightening Torque*
7247-IP7-1	7247N-IP7-1	8IP-7	8IP-7TL	8IP-7B	7.4 in-lbs (84 N-cm)

*Tightening torques are calculated with a friction coefficient of $\mu = 0.14$ and develop 90% of ultimate yield strength

Chamfer inserts sold separately in multiples of 10 | Screws sold in multiples of 10



i = Imperial (in)
m = Metric (mm)

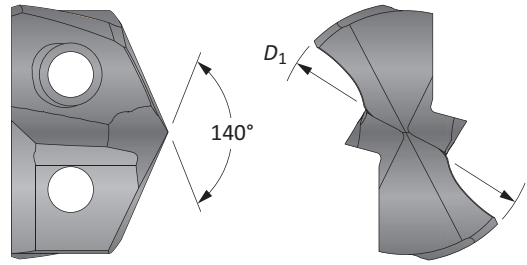
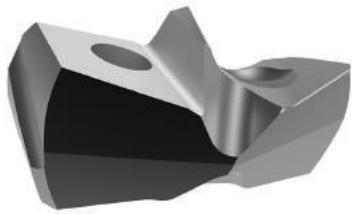

GEN3SYS XT Pro Drill Inserts

13 Series | Diameter Range: 0.5118" - 0.5511" (13.00mm - 13.99mm)



Fractional Equivalent	Insert				
	D_1 inch	D_1 mm	Part No. P	Part No. K	Part No. N
-	0.5118	13.00	XTP13-13.00	XTK13-13.00	XTN13-13.00
33/64	0.5156	13.10	XTP13-13.10	XTK13-13.10	XTN13-13.10
-	0.5197	13.20	XTP13-13.20	XTK13-13.20	XTN13-13.20
-	0.5236	13.30	XTP13-13.30	XTK13-13.30	XTN13-13.30
-	0.5276	13.40	XTP13-13.40	XTK13-13.40	XTN13-13.40
17/32	0.5313	13.49	XTP13-13.49	XTK13-13.49	XTN13-13.49
-	0.5315	13.50	XTP13-13.50	XTK13-13.50	XTN13-13.50
-	0.5354	13.60	XTP13-13.60	XTK13-13.60	XTN13-13.60
-	0.5394	13.70	XTP13-13.70	XTK13-13.70	XTN13-13.70
-	0.5433	13.80	XTP13-13.80	XTK13-13.80	XTN13-13.80
35/64	0.5469	13.89	XTP13-13.89	XTK13-13.89	XTN13-13.89

Inserts sold in multiples of 1

A20: 68 - 83

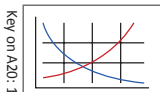

A20: 6 - 9



Sizes not shown are available upon request.
When ordering, please follow the example below:

Imperial:	0.5180", Steel, 13 series = use Part No. XTP13-13.16
Metric:	13.16mm, Steel, 13 series = use Part No. XTP13-13.16

GEN3SYS XT Pro Drill Insert Holders

13 Series | Diameter Range: 0.5118" - 0.5511" (13.00mm - 13.99mm)

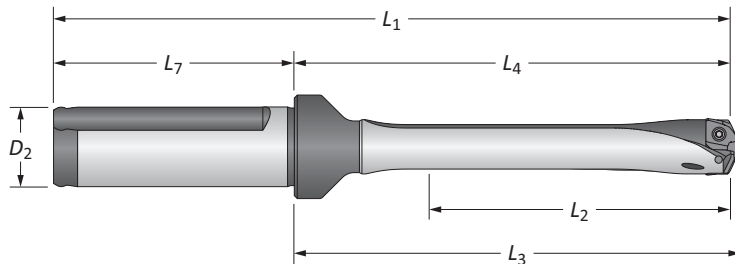

Flute	Body					Shank			Part No.
	Length	L ₂	L ₄	L ₃	L ₁	L ₇	D ₂	Flat	
i Straight 	3xD	1-21/32	2-23/32	2-13/16	4-3/4	2-1/32	3/4	YES	HXT0313S-075F
	3xD	1-21/32	2-23/32	2-13/16	4-3/4	2-1/32	3/4	NO	HXT0313S-075C
	5xD	2-3/4	3-13/16	3-29/32	5-27/32	2-1/32	3/4	YES	HXT0513S-075F
	5xD	2-3/4	3-13/16	3-29/32	5-27/32	2-1/32	3/4	NO	HXT0513S-075C
	7xD	3-55/64	4-59/64	5-1/64	6-61/64	2-1/32	3/4	YES	HXT0713S-075F
	7xD	3-55/64	4-59/64	5-1/64	6-61/64	2-1/32	3/4	NO	HXT0713S-075C
	10xD	5-33/64	6-37/64	6-43/64	8-39/64	2-1/32	3/4	YES	HXT1013S-075F
10xD	5-33/64	6-37/64	6-43/64	8-39/64	2-1/32	3/4	NO	HXT1013S-075C	
ii Straight 	3xD	42.0	69.0	71.4	119.0	50.0	20.0	YES	HXT0313S-20FM
	3xD	42.0	69.0	71.4	119.0	50.0	20.0	NO	HXT0313S-20CM
	5xD	69.9	96.8	99.2	146.8	50.0	20.0	YES	HXT0513S-20FM
	5xD	69.9	96.8	99.2	146.8	50.0	20.0	NO	HXT0513S-20CM
	7xD	98.0	125.0	127.4	175.0	50.0	20.0	YES	HXT0713S-20FM
	7xD	98.0	125.0	127.4	175.0	50.0	20.0	NO	HXT0713S-20CM
	10xD	140.0	167.0	169.4	217.0	50.0	20.0	YES	HXT1013S-20FM
	10xD	140.0	167.0	169.4	217.0	50.0	20.0	NO	HXT1013S-20CM

Connection Accessories

					Admissible Tightening Torque*
7247-IP7-1	7247N-IP7-1	8IP-7	8IP-7TL	8IP-7B	7.4 in-lbs (84 N-cm)

*Tightening torques are calculated with a friction coefficient of $\mu = 0.14$ and develop 90% of ultimate yield strength

⚠ WARNING Refer to Speed and Feed charts for recommended adjustments to speeds and feeds. Refer to page A20: 86 for deep hole drilling guidelines in this section of the catalog. Visit www.alliedmachine.com/DeepHoleGuidelines for the most up-to-date information and procedures. Factory technical assistance is available for your specific applications through our Application Engineering Team.

i = Imperial (in)
 ii = Metric (mm)

Screws sold in multiples of 10

A DRILLING
 B BORING
 C REAMING
 D BURNISHING
 E THREADING
 X SPECIALS



GEN3SYS XT Drill Inserts

13 Series | Diameter Range: 0.5118" - 0.5511" (13.00mm - 13.99mm)

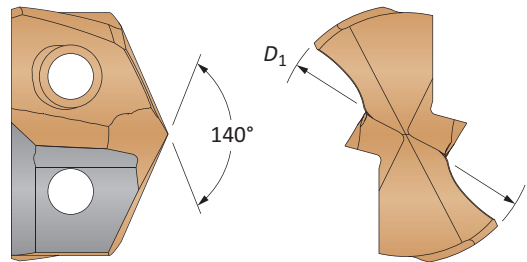
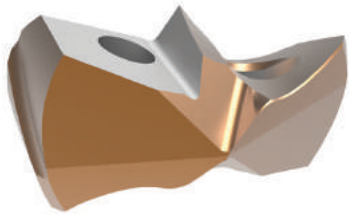

Carbide Substrate	Insert			Standard Part No.	Low Rake Part No.	Cast Iron Part No.	Stainless Part No.
	Fractional Equivalent	D ₁ inch	D ₁ mm				
C1 (K35)	-	0.5118	13.00	7C113P-13	7C113P-13LR	-	-
	33/64	0.5156	13.08	7C113P-.515	7C113P-.515LR	-	-
	17/32	0.5312	13.49	7C113P-0017	7C113P-0017LR	-	-
	-	0.5315	13.50	7C113P-13.5	7C113P-13.5LR	-	-
	35/64	0.5469	13.89	7C113P-.546	7C113P-.546LR	-	-
C2 (K20)	-	0.5118	13.00	7C213P-13	7C213P-13LR	7C213P-13CI	7C213P-13AS
	33/64	0.5156	13.08	7C213P-.515	7C213P-.515LR	7C213P-.515CI	7C213P-.515AS
	17/32	0.5312	13.49	7C213P-0017	7C213P-0017LR	7C213P-0017CI	7C213P-0017AS
	-	0.5315	13.50	7C213P-13.5	7C213P-13.5LR	7C213P-13.5CI	7C213P-13.5AS
	35/64	0.5469	13.89	7C213P-.546	7C213P-.546LR	7C213P-.546CI	7C213P-.546AS

Inserts sold in multiples of 1

A20: 68 - 83

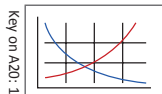

A20: 6 - 9



Sizes not shown are available upon request.

When ordering, please follow the example below:

Imperial:	0.5200", 13 series, C2 = use Part No. 7C213P-.5200
Metric:	13.20mm, 13 series, C2 = use Part No. 7C213P-13.20

GEN3SYS XT Standard Drill Insert Holders

13 Series | Diameter Range: 0.5118" - 0.5511" (13.00mm - 13.99mm)

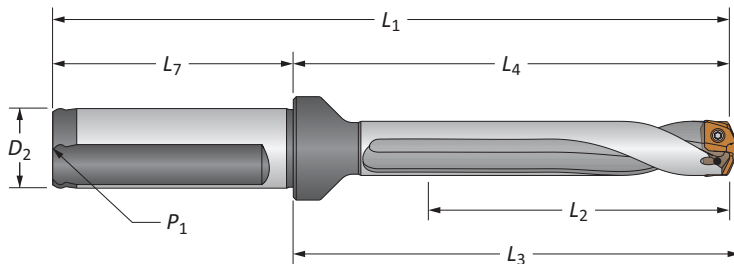

Straight and Helical

Flute	Length	Body				Shank				Flat	Part No.
		L ₂	L ₄	L ₃	L ₁	L ₇	D ₂	P ₁			
	3xD	1-21/32	2-23/32	2-13/16	4-3/4	2-1/32	3/4	1/8	YES	60313S-075F	
	5xD	2-3/4	3-13/16	3-29/32	5-27/32	2-1/32	3/4	1/8	YES	60513S-075F	
	7xD	3-55/64	4-59/64	5-1/64	6-61/64	2-1/32	3/4	1/8	YES	60713S-075F	
	Stub	5/8	1-11/16	1-25/32	3-23/32	2-1/32	3/4	1/8	YES	60113H-075F	
	3xD	1-21/32	2-23/32	2-13/16	4-3/4	2-1/32	3/4	1/8	YES	60313H-075F	
	3xD	1-21/32	2-23/32	2-13/16	4-3/4	2-1/32	3/4	1/8	NO	60313H-075C	
	5xD	2-3/4	3-13/16	3-29/32	5-27/32	2-1/32	3/4	1/8	YES	60513H-075F	
	5xD	2-3/4	3-13/16	3-29/32	5-27/32	2-1/32	3/4	1/8	NO	60513H-075C	
	7xD	3-55/64	4-59/64	5-1/64	6-61/64	2-1/32	3/4	1/8	YES	60713H-075F	
	7xD	3-55/64	4-59/64	5-1/64	6-61/64	2-1/32	3/4	1/8	NO	60713H-075C	
	Straight	3xD	42.0	69.0	71.4	119.0	50.0	20.0	1/8*	YES	60313S-20FM
		5xD	69.9	96.8	99.2	146.8	50.0	20.0	1/8*	YES	60513S-20FM
		7xD	98.0	125.0	127.4	175.0	50.0	20.0	1/8*	YES	60713S-20FM
	Helical	Stub	16.0	43.0	45.2	93.0	50.0	20.0	1/8*	YES	60113H-20FM
		3xD	42.0	69.0	71.4	119.0	50.0	20.0	1/8*	YES	60313H-20FM
		3xD	42.0	69.0	71.4	119.0	50.0	20.0	1/8*	NO	60313H-20CM
		5xD	69.9	96.8	99.2	146.8	50.0	20.0	1/8*	YES	60513H-20FM
		5xD	69.9	96.8	99.2	146.8	50.0	20.0	1/8*	NO	60513H-20CM
		7xD	98.0	125.0	127.4	175.0	50.0	20.0	1/8*	YES	60713H-20FM
		7xD	98.0	125.0	127.4	175.0	50.0	20.0	1/8*	NO	60713H-20CM

*Thread to BSP and ISO 7-1

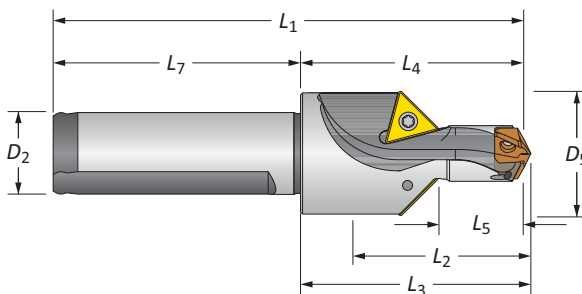
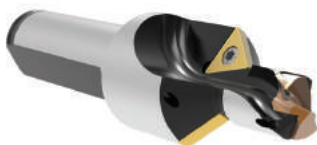

Drill / Chamfer

	Step		Body				Shank		Part No.	Chamfer Insert
	D ₅	L ₅	L ₂	L ₄	L ₃	L ₁	L ₇	D ₂		
	1-1/64	49/64	1	1-11/16	1-25/32	3-23/32	2-1/32	3/4	60113C45-075F	TCMT-110204
	25.8	19.5	25.4	43.0	45.2	93.0	50.0	20.0	60113C45-20FM	TCMT-110204

Connection Accessories

Insert Screws	Nylon Locking Screws	Insert Driver	Preset Torque Hand Driver	Replacement Tips	Admissible Tightening Torque*
7247-IP7-1	7247N-IP7-1	8IP-7	8IP-7TL	8IP-7B	7.4 in-lbs (84 N-cm)

*Tightening torques are calculated with a friction coefficient of $\mu = 0.14$ and develop 90% of ultimate yield strength



Chamfer inserts sold separately in multiples of 10 | Screws sold in multiples of 10

= Imperial (in)
 = Metric (mm)

GEN3SYS XT Pro Drill Inserts

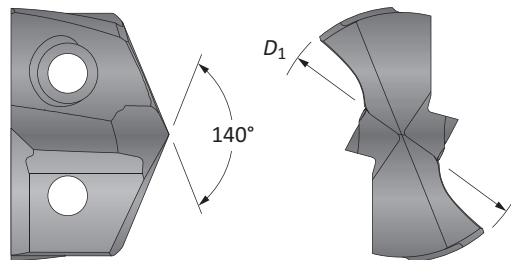
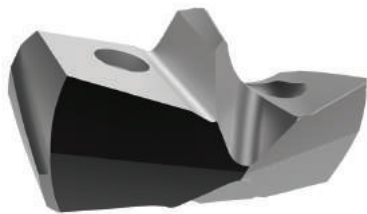
14 Series | Diameter Range: 0.5512" - 0.5905" (14.00mm - 14.99mm)



Fractional Equivalent	Insert				
	D_1 inch	D_1 mm	Part No. P	Part No. K	Part No. N
-	0.5512	14.00	XTP14-14.00	XTK14-14.00	XTN14-14.00
-	0.5551	14.10	XTP14-14.10	XTK14-14.10	XTN14-14.10
-	0.5591	14.20	XTP14-14.20	XTK14-14.20	XTN14-14.20
9/16	0.5625	14.29	XTP14-14.29	XTK14-14.29	XTN14-14.29
-	0.5669	14.40	XTP14-14.40	XTK14-14.40	XTN14-14.40
-	0.5709	14.50	XTP14-14.50	XTK14-14.50	XTN14-14.50
-	0.5748	14.60	XTP14-14.60	XTK14-14.60	XTN14-14.60
37/64	0.5781	14.68	XTP14-14.68	XTK14-14.68	XTN14-14.68
-	0.5827	14.80	XTP14-14.80	XTK14-14.80	XTN14-14.80
-	0.5866	14.90	XTP14-14.90	XTK14-14.90	XTN14-14.90

Inserts sold in multiples of 1

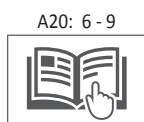
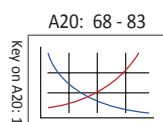



Sizes not shown are available upon request.	
When ordering, please follow the example below:	
Imperial:	0.5180", Steel, 13 series = use Part No. XTP13-13.16
Metric:	13.16mm, Steel, 13 series = use Part No. XTP13-13.16



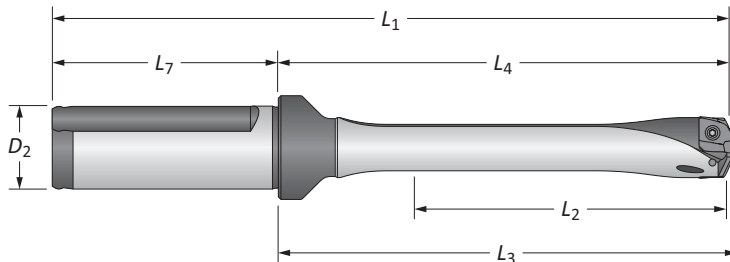

GEN3SYS XT Pro Drill Insert Holders

14 Series | Diameter Range: 0.5512" - 0.5905" (14.00mm - 14.99mm)

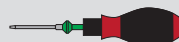

Flute	Body					Shank			Part No.
	Length	L ₂	L ₄	L ₃	L ₁	L ₇	D ₂	Flat	
i Straight 	3xD	1-49/64	2-27/32	2-61/64	4-7/8	2-1/32	3/4	YES	HXT0314S-075F
	3xD	1-49/64	2-27/32	2-61/64	4-7/8	2-1/32	3/4	NO	HXT0314S-075C
	5xD	2-61/64	4-1/32	4-1/8	6-1/16	2-1/32	3/4	YES	HXT0514S-075F
	5xD	2-61/64	4-1/32	4-1/8	6-1/16	2-1/32	3/4	NO	HXT0514S-075C
	7xD	4-1/8	5-13/64	5-5/16	7-15/64	2-1/32	3/4	YES	HXT0714S-075F
	7xD	4-1/8	5-13/64	5-5/16	7-15/64	2-1/32	3/4	NO	HXT0714S-075C
	10xD	5-29/32	6-63/64	7-5/64	9-1/64	2-1/32	3/4	YES	⚠ HXT1014S-075F
10xD	5-29/32	6-63/64	7-5/64	9-1/64	2-1/32	3/4	NO	⚠ HXT1014S-075C	
iii Straight 	3xD	44.8	72.2	74.9	122.2	50.0	20.0	YES	HXT0314S-20FM
	3xD	44.8	72.2	74.9	122.2	50.0	20.0	NO	HXT0314S-20CM
	5xD	75.0	102.4	104.9	152.4	50.0	20.0	YES	HXT0514S-20FM
	5xD	75.0	102.4	104.9	152.4	50.0	20.0	NO	HXT0514S-20CM
	7xD	104.8	132.2	134.8	182.2	50.0	20.0	YES	HXT0714S-20FM
	7xD	104.8	132.2	134.8	182.2	50.0	20.0	NO	HXT0714S-20CM
	10xD	149.9	177.4	179.8	227.4	50.0	20.0	YES	⚠ HXT1014S-20FM
	10xD	149.9	177.4	179.8	227.4	50.0	20.0	NO	⚠ HXT1014S-20CM

Connection Accessories

					Admissible Tightening Torque*
Insert Screws 7247-IP7-1	Nylon Locking Screws 7247N-IP7-1	Insert Driver 8IP-7	Preset Torque Hand Driver 8IP-7TL	Replacement Tips 8IP-7B	7.4 in-lbs (84 N-cm)

*Tightening torques are calculated with a friction coefficient of $\mu = 0.14$ and develop 90% of ultimate yield strength

⚠ WARNING Refer to Speed and Feed charts for recommended adjustments to speeds and feeds. Refer to page A20: 86 for deep hole drilling guidelines in this section of the catalog. Visit www.alliedmachine.com/DeepHoleGuidelines for the most up-to-date information and procedures. Factory technical assistance is available for your specific applications through our Application Engineering Team.

i = Imperial (in)
iii = Metric (mm)

Screws sold in multiples of 10

GEN3SYS XT Drill Inserts

14 Series | Diameter Range: 0.5512" - 0.5905" (14.00mm - 14.99mm)

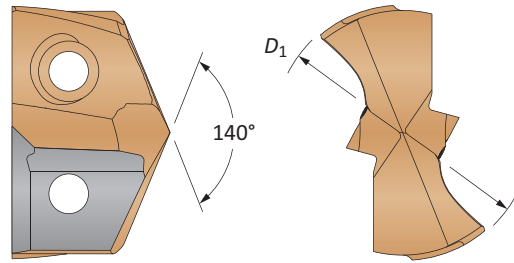
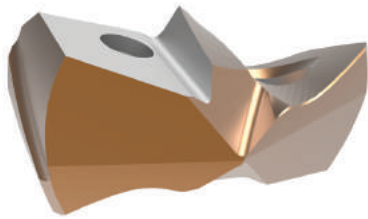

Carbide Substrate	Insert			Standard Part No.	Low Rake Part No.	Cast Iron Part No.	Stainless Part No.
	Fractional Equivalent	D_1 inch	D_1 mm				
C1 (K35)	-	0.5512	14.00	7C114P-14	7C114P-14LR	-	-
	9/16	0.5625	14.29	7C114P-0018	7C114P-0018LR	-	-
	-	0.5709	14.50	7C114P-14.5	7C114P-14.5LR	-	-
	37/64	0.5781	14.68	7C114P-.578	7C114P-.578LR	-	-
	-	0.5827	14.80	7C114P-14.8	7C114P-14.8LR	-	-
C2 (K20)	-	0.5512	14.00	7C214P-14	7C214P-14LR	7C214P-14CI	7C214P-14AS
	9/16	0.5625	14.29	7C214P-0018	7C214P-0018LR	7C214P-0018CI	7C214P-0018AS
	-	0.5709	14.50	7C214P-14.5	7C214P-14.5LR	7C214P-14.5CI	7C214P-14.5AS
	37/64	0.5781	14.68	7C214P-.578	7C214P-.578LR	7C214P-.578CI	7C214P-.578AS
	-	0.5827	14.80	7C214P-14.8	7C214P-14.8LR	7C214P-14.8CI	7C214P-14.8AS

Inserts sold in multiples of 1

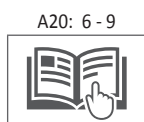
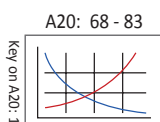

Sizes not shown are available upon request.	
When ordering, please follow the example below:	
Imperial:	0.5200", 13 series, C2 = use Part No. 7C213P-.5200
Metric:	13.20mm, 13 series, C2 = use Part No. 7C213P-13.20

GEN3SYS XT Standard Drill Insert Holders

14 Series | Diameter Range: 0.5512" - 0.5905" (14.00mm - 14.99mm)

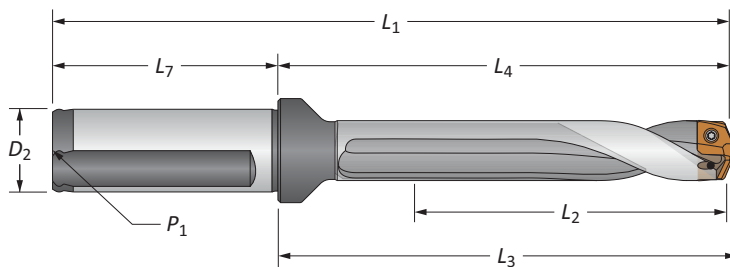

Straight and Helical

Flute	Length	Body				Shank				Flat	Part No.
		L ₂	L ₄	L ₃	L ₁	L ₇	D ₂	P ₁			
	3xD	1-49/64	2-27/32	2-61/64	4-7/8	2-1/32	3/4	1/8	YES	60314S-075F	
	5xD	2-61/64	4-1/32	4-1/8	6-1/16	2-1/32	3/4	1/8	YES	60514S-075F	
	7xD	4-1/8	5-13/64	5-5/16	7-15/64	2-1/32	3/4	1/8	YES	60714S-075F	
	Stub	11/16	1-3/4	1-55/64	3-25/32	2-1/32	3/4	1/8	YES	60114H-075F	
	3xD	1-49/64	2-27/32	2-61/64	4-7/8	2-1/32	3/4	1/8	YES	60314H-075F	
	3xD	1-49/64	2-27/32	2-61/64	4-7/8	2-1/32	3/4	1/8	NO	60314H-075C	
	5xD	2-61/64	4-1/32	4-1/8	6-1/16	2-1/32	3/4	1/8	YES	60514H-075F	
	5xD	2-61/64	4-1/32	4-1/8	6-1/16	2-1/32	3/4	1/8	NO	60514H-075C	
	7xD	4-1/8	5-13/64	5-5/16	7-15/64	2-1/32	3/4	1/8	YES	60714H-075F	
	7xD	4-1/8	5-13/64	5-5/16	7-15/64	2-1/32	3/4	1/8	NO	60714H-075C	
	3xD	44.8	72.2	74.9	122.2	50.0	20.0	1/8*	YES	60314S-20FM	
	5xD	75.0	102.4	104.9	152.4	50.0	20.0	1/8*	YES	60514S-20FM	
	7xD	104.8	132.2	134.8	182.2	50.0	20.0	1/8*	YES	60714S-20FM	
	Stub	17.5	44.5	47.2	94.5	50.0	20.0	1/8*	YES	60114H-20FM	
	3xD	44.8	72.2	74.9	122.2	50.0	20.0	1/8*	YES	60314H-20FM	
	3xD	44.8	72.2	74.9	122.2	50.0	20.0	1/8*	NO	60314H-20CM	
	5xD	75.0	102.4	104.9	152.4	50.0	20.0	1/8*	YES	60514H-20FM	
	5xD	75.0	102.4	104.9	152.4	50.0	20.0	1/8*	NO	60514H-20CM	
	7xD	104.8	132.2	134.8	182.2	50.0	20.0	1/8*	YES	60714H-20FM	
	7xD	104.8	132.2	134.8	182.2	50.0	20.0	1/8*	NO	60714H-20CM	

*Thread to BSP and ISO 7-1

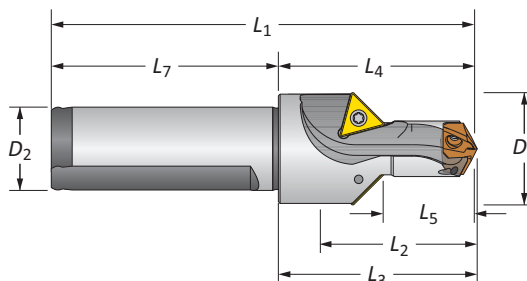
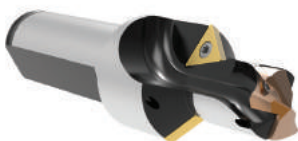

Drill / Chamfer

	Step		Body				Shank		Part No.	Chamfer Insert
	D ₅	L ₅	L ₂	L ₄	L ₃	L ₁	L ₇	D ₂		
i	1-3/64	53/64	1-3/64	1-3/4	1-55/64	3-25/32	2-1/32	3/4	60114C45-075F	TCMT-110204
m	26.7	21.0	26.8	44.6	47.2	94.6	50.0	20.0	60114C45-20FM	TCMT-110204

Connection Accessories

Insert Screws	Nylon Locking Screws	Insert Driver	Preset Torque Hand Driver	Replacement Tips	Admissible Tightening Torque*
7247-IP7-1	7247N-IP7-1	8IP-7	8IP-7TL	8IP-7B	7.4 in-lbs (84 N-cm)

*Tightening torques are calculated with a friction coefficient of $\mu = 0.14$ and develop 90% of ultimate yield strength



Chamfer inserts sold separately in multiples of 10 | Screws sold in multiples of 10

i = Imperial (in)
m = Metric (mm)

GEN3SYS XT Pro Drill Inserts

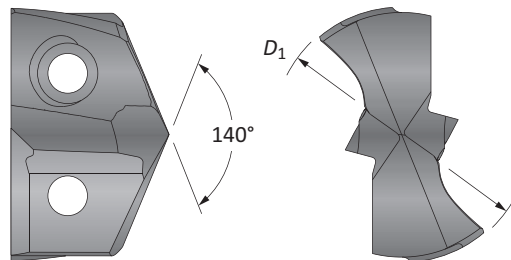
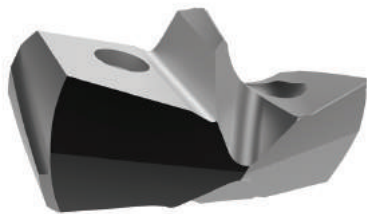
15 Series | Diameter Range: 0.5906" - 0.6298" (15.00mm - 15.99mm)



Fractional Equivalent	Insert				
	D_1 inch	D_1 mm	Part No. P	Part No. K	Part No. N
-	0.5906	15.00	XTP15-15.00	XTK15-15.00	XTN15-15.00
19/32	0.5938	15.08	XTP15-15.08	XTK15-15.08	XTN15-15.08
-	0.5984	15.20	XTP15-15.20	XTK15-15.20	XTN15-15.20
-	0.6024	15.30	XTP15-15.30	XTK15-15.30	XTN15-15.30
-	0.6063	15.40	XTP15-15.40	XTK15-15.40	XTN15-15.40
33/64	0.6094	15.48	XTP15-15.48	XTK15-15.48	XTN15-15.48
-	0.6102	15.50	XTP15-15.50	XTK15-15.50	XTN15-15.50
-	0.6142	15.60	XTP15-15.60	XTK15-15.60	XTN15-15.60
-	0.6181	15.70	XTP15-15.70	XTK15-15.70	XTN15-15.70
-	0.6220	15.80	XTP15-15.80	XTK15-15.80	XTN15-15.80
5/8	0.6250	15.88	XTP15-15.88	XTK15-15.88	XTN15-15.88

Inserts sold in multiples of 1

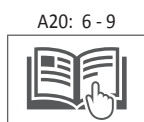
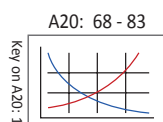

Sizes not shown are available upon request.	
When ordering, please follow the example below:	
Imperial:	0.5180", Steel, 13 series = use Part No. XTP13-13.16
Metric:	13.16mm, Steel, 13 series = use Part No. XTP13-13.16

GEN3SYS XT Pro Drill Insert Holders

15 Series | Diameter Range: 0.5906" - 0.6298" (15.00mm - 15.99mm)

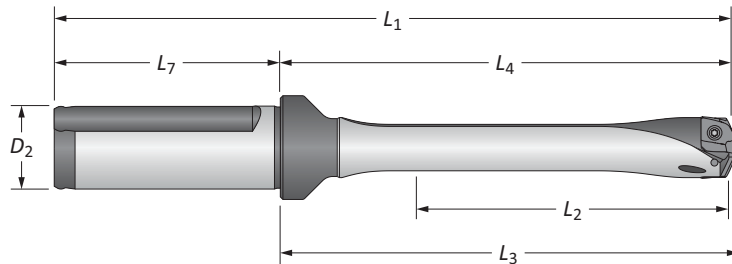

Flute	Body					Shank			Part No.
	Length	L ₂	L ₄	L ₃	L ₁	L ₇	D ₂	Flat	
i Straight 	3xD	1-57/64	2-61/64	3-3/64	4-63/64	2-1/32	3/4	YES	HXT0315S-075F
	3xD	1-57/64	2-61/64	3-3/64	4-63/64	2-1/32	3/4	NO	HXT0315S-075C
	5xD	3-9/64	4-13/64	4-5/16	6-15/64	2-1/32	3/4	YES	HXT0515S-075F
	5xD	3-9/64	4-13/64	4-5/16	6-15/64	2-1/32	3/4	NO	HXT0515S-075C
	7xD	4-13/32	5-15/32	5-37/64	7-1/2	2-1/32	3/4	YES	HXT0715S-075F
	7xD	4-13/32	5-15/32	5-37/64	7-1/2	2-1/32	3/4	NO	HXT0715S-075C
	10xD	6-19/64	7-23/64	7-29/64	9-25/64	2-1/32	3/4	YES	HXT1015S-075F
10xD	6-19/64	7-23/64	7-29/64	9-25/64	2-1/32	3/4	NO	HXT1015S-075C	
ii Straight 	3xD	48.0	75.0	77.5	125.0	50.0	20.0	YES	HXT0315S-20FM
	3xD	48.0	75.0	77.5	125.0	50.0	20.0	NO	HXT0315S-20CM
	5xD	79.8	106.8	109.5	156.8	50.0	20.0	YES	HXT0515S-20FM
	5xD	79.8	106.8	109.5	156.8	50.0	20.0	NO	HXT0515S-20CM
	7xD	111.9	138.9	141.5	188.9	50.0	20.0	YES	HXT0715S-20FM
	7xD	111.9	138.9	141.5	188.9	50.0	20.0	NO	HXT0715S-20CM
	10xD	159.9	186.9	189.5	236.9	50.0	20.0	YES	HXT1015S-20FM
	10xD	159.9	186.9	189.5	236.9	50.0	20.0	NO	HXT1015S-20CM

Connection Accessories

					Admissible Tightening Torque*
7247-IP7-1	7247N-IP7-1	8IP-7	8IP-7TL	8IP-7B	7.4 in-lbs (84 N-cm)

*Tightening torques are calculated with a friction coefficient of $\mu = 0.14$ and develop 90% of ultimate yield strength

⚠ WARNING Refer to Speed and Feed charts for recommended adjustments to speeds and feeds. Refer to page A20: 86 for deep hole drilling guidelines in this section of the catalog. Visit www.alliedmachine.com/DeepHoleGuidelines for the most up-to-date information and procedures. Factory technical assistance is available for your specific applications through our Application Engineering Team.

i = Imperial (in)
 ii = Metric (mm)

Screws sold in multiples of 10



GEN3SYS XT Drill Inserts

15 Series | Diameter Range: 0.5906" - 0.6298" (15.00mm - 15.99mm)

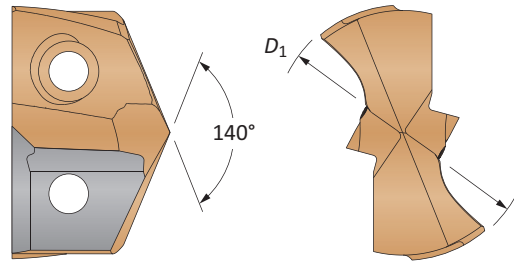
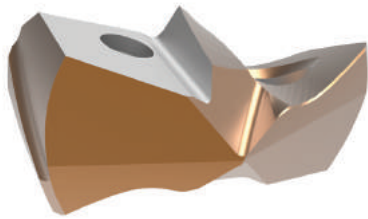

Carbide Substrate	Insert			Standard Part No.	Low Rake Part No.	Cast Iron Part No.	Stainless Part No.
	Fractional Equivalent	D_1 inch	D_1 mm				
C1 (K35)	-	0.5906	15.00	7C115P-15	7C115P-15LR	-	-
	19/32	0.5938	15.08	7C115P-0019	7C115P-0019LR	-	-
	-	0.6004	15.25	7C115P-15.25	7C115P-15.25LR	-	-
	39/64	0.6094	15.48	7C115P-.609	7C115P-.609LR	-	-
	-	0.6103	15.50	7C115P-15.5	7C115P-15.5LR	-	-
	-	0.6181	15.70	7C115P-.618	7C115P-.618LR	-	-
	5/8	0.6250	15.88	7C115P-0020	7C115P-0020LR	-	-
C2 (K20)	-	0.5906	15.00	7C215P-15	7C215P-15LR	7C215P-15CI	7C215P-15AS
	19/32	0.5938	15.08	7C215P-0019	7C215P-0019LR	7C215P-0019CI	7C215P-0019AS
	-	0.6004	15.25	7C215P-15.25	7C215P-15.25LR	7C215P-15.25CI	7C215P-15.25AS
	39/64	0.6094	15.48	7C215P-.609	7C215P-.609LR	7C215P-.609CI	7C215P-.609AS
	-	0.6103	15.50	7C215P-15.5	7C215P-15.5LR	7C215P-15.5CI	7C215P-15.5AS
	-	0.6181	15.70	7C215P-.618	7C215P-.618LR	7C215P-.618CI	7C215P-.618AS
	5/8	0.6250	15.88	7C215P-0020	7C215P-0020LR	7C215P-0020CI	7C215P-0020AS

Inserts sold in multiples of 1

A20: 68 - 83

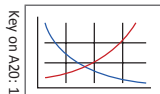

A20: 6 - 9



Key on A20: 1

Sizes not shown are available upon request.
When ordering, please follow the example below:

Imperial:	0.5200", 13 series, C2 = use Part No. 7C213P-.5200
Metric:	13.20mm, 13 series, C2 = use Part No. 7C213P-13.20

GEN3SYS XT Standard Drill Insert Holders

15 Series | Diameter Range: 0.5906" - 0.6298" (15.00mm - 15.99mm)

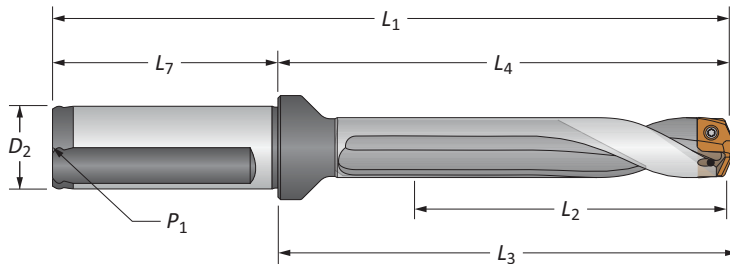

Straight and Helical

Flute	Length	Body				Shank				Flat	Part No.
		L ₂	L ₄	L ₃	L ₁	L ₇	D ₂	P ₁			
Straight	3xD	1-57/64	2-61/64	3-3/64	4-63/64	2-1/32	3/4	1/8	YES	60315S-075F	
	5xD	3-9/64	4-13/64	4-5/16	6-15/64	2-1/32	3/4	1/8	YES	60515S-075F	
	7xD	4-13/32	5-15/32	5-37/64	7-1/2	2-1/32	3/4	1/8	YES	60715S-075F	
Helical	Stub	11/16	1-3/4	1-27/32	3-25/32	2-1/32	3/4	1/8	YES	60115H-075F	
	3xD	1-57/64	2-61/64	3-3/64	4-63/64	2-1/32	3/4	1/8	YES	60315H-075F	
	3xD	1-57/64	2-61/64	3-3/64	4-63/64	2-1/32	3/4	1/8	NO	60315H-075C	
	5xD	3-9/64	4-13/64	4-5/16	6-15/64	2-1/32	3/4	1/8	YES	60515H-075F	
	5xD	3-9/64	4-13/64	4-5/16	6-15/64	2-1/32	3/4	1/8	NO	60515H-075C	
	7xD	4-13/32	5-15/32	5-37/64	7-1/2	2-1/32	3/4	1/8	YES	60715H-075F	
	7xD	4-13/32	5-15/32	5-37/64	7-1/2	2-1/32	3/4	1/8	NO	60715H-075C	
Straight	3xD	48.0	75.0	77.5	125.0	50.0	20.0	1/8*	YES	60315S-20FM	
	5xD	79.8	106.8	109.5	156.8	50.0	20.0	1/8*	YES	60515S-20FM	
	7xD	111.9	138.9	141.5	188.9	50.0	20.0	1/8*	YES	60715S-20FM	
	Stub	17.5	44.5	46.8	94.5	50.0	20.0	1/8*	YES	60115H-20FM	
	3xD	48.0	75.0	77.5	125.0	50.0	20.0	1/8*	YES	60315H-20FM	
	3xD	48.0	75.0	77.5	125.0	50.0	20.0	1/8*	NO	60315H-20CM	
	5xD	79.8	106.8	109.5	156.8	50.0	20.0	1/8*	YES	60515H-20FM	
	5xD	79.8	106.8	109.5	156.8	50.0	20.0	1/8*	NO	60515H-20CM	
	7xD	111.9	138.9	141.5	188.9	50.0	20.0	1/8*	YES	60715H-20FM	
	7xD	111.9	138.9	141.5	188.9	50.0	20.0	1/8*	NO	60715H-20CM	

*Thread to BSP and ISO 7-1

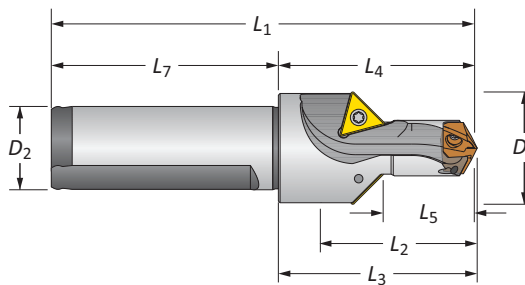
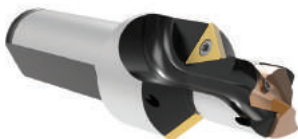

Drill / Chamfer

Step	Body					Shank		Part No.	Chamfer Insert
	D ₅	L ₅	L ₂	L ₄	L ₃	L ₁	L ₇		
1-1/16	57/64	1-1/16	1-47/64	1-27/32	3-49/64	2-1/32	3/4	60115C45-075F	TCMT-110204
27.0	22.5	26.9	44.3	46.8	94.3	50.0	20.0	60115C45-20FM	TCMT-110204

Connection Accessories

Insert Screws	Nylon Locking Screws	Insert Driver	Preset Torque Hand Driver	Replacement Tips	Admissible Tightening Torque*
7247-IP7-1	7247N-IP7-1	8IP-7	8IP-7TL	8IP-7B	7.4 in-lbs (84 N-cm)

*Tightening torques are calculated with a friction coefficient of $\mu = 0.14$ and develop 90% of ultimate yield strength

Chamfer inserts sold separately in multiples of 10 | Screws sold in multiples of 10



= Imperial (in)
 = Metric (mm)

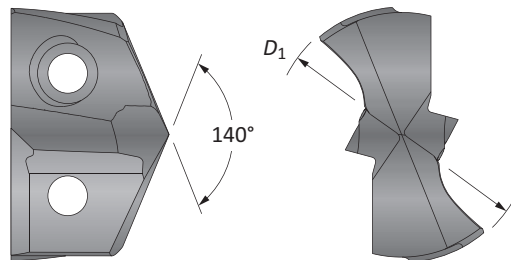
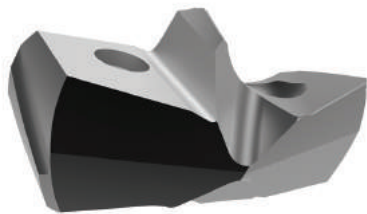

GEN3SYS XT Pro Drill Inserts

16 Series | Diameter Range: 0.6299" - 0.6692" (16.00mm - 16.99mm)



Fractional Equivalent	Insert				
	D_1 inch	D_1 mm	Part No. P	Part No. K	Part No. N
-	0.6299	16.00	XTP16-16.00	XTK16-16.00	XTN16-16.00
-	0.6331	16.08	XTP16-16.08	XTK16-16.08	XTN16-16.08
-	0.6378	16.20	XTP16-16.20	XTK16-16.20	XTN16-16.20
41/64	0.6406	16.27	XTP16-16.27	XTK16-16.27	XTN16-16.27
-	0.6457	16.40	XTP16-16.40	XTK16-16.40	XTN16-16.40
-	0.6496	16.50	XTP16-16.50	XTK16-16.50	XTN16-16.50
-	0.6535	16.60	XTP16-16.60	XTK16-16.60	XTN16-16.60
21/32	0.6563	16.67	XTP16-16.67	XTK16-16.67	XTN16-16.67
-	0.6614	16.80	XTP16-16.80	XTK16-16.80	XTN16-16.80
-	0.6654	16.90	XTP16-16.90	XTK16-16.90	XTN16-16.90

Inserts sold in multiples of 1

A20: 68 - 83

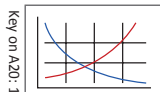

A20: 6 - 9



Sizes not shown are available upon request.

When ordering, please follow the example below:

Imperial:	0.5180", Steel, 13 series = use Part No. XTP13-13.16
Metric:	13.16mm, Steel, 13 series = use Part No. XTP13-13.16

GEN3SYS XT Pro Drill Insert Holders

16 Series | Diameter Range: 0.6299" - 0.6692" (16.00mm - 16.99mm)

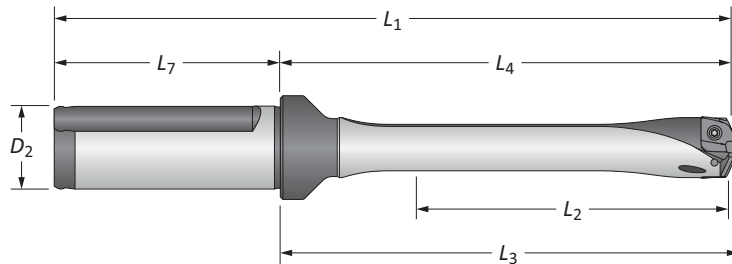

Flute	Body					Shank			Part No.
	Length	L ₂	L ₄	L ₃	L ₁	L ₇	D ₂	Flat	
i Straight	3xD	2	3-13/64	3-5/16	5-15/64	2-1/32	3/4	YES	HXT0316S-075F
	3xD	2	3-13/64	3-5/16	5-15/64	2-1/32	3/4	NO	HXT0316S-075C
	5xD	3-11/32	4-17/32	4-21/32	6-9/16	2-1/32	3/4	YES	HXT0516S-075F
	5xD	3-11/32	4-17/32	4-21/32	6-9/16	2-1/32	3/4	NO	HXT0516S-075C
	7xD	4-11/16	5-7/8	5-63/64	7-29/32	2-1/32	3/4	YES	HXT0716S-075F
	7xD	4-11/16	5-7/8	5-63/64	7-29/32	2-1/32	3/4	NO	HXT0716S-075C
	10xD	6-11/16	7-7/8	8	9-29/32	2-1/32	3/4	YES	HXT1016S-075F
10xD	6-11/16	7-7/8	8	9-29/32	2-1/32	3/4	NO	HXT1016S-075C	
ii Straight	3xD	50.8	81.3	84.2	131.3	50.0	20.0	YES	HXT0316S-20FM
	3xD	50.8	81.3	84.2	131.3	50.0	20.0	NO	HXT0316S-20CM
	5xD	85.0	115.1	118.2	165.1	50.0	20.0	YES	HXT0516S-20FM
	5xD	85.0	115.1	118.2	165.1	50.0	20.0	NO	HXT0516S-20CM
	7xD	119.0	149.2	152.0	199.2	50.0	20.0	YES	HXT0716S-20FM
	7xD	119.0	149.2	152.0	199.2	50.0	20.0	NO	HXT0716S-20CM
	10xD	169.9	200.0	203.2	250.0	50.0	20.0	YES	HXT1016S-20FM
	10xD	169.9	200.0	203.2	250.0	50.0	20.0	NO	HXT1016S-20CM

Connection Accessories

					Admissible Tightening Torque*
72556-IP8-1	72556N-IP8-1	8IP-8	8IP-8TL	8IP-8B	15.5 in-lbs (175 N-cm)

*Tightening torques are calculated with a friction coefficient of $\mu = 0.14$ and develop 90% of ultimate yield strength

WARNING Refer to Speed and Feed charts for recommended adjustments to speeds and feeds. Refer to page A20: 86 for deep hole drilling guidelines in this section of the catalog. Visit www.alliedmachine.com/DeepHoleGuidelines for the most up-to-date information and procedures. Factory technical assistance is available for your specific applications through our Application Engineering Team.

i = Imperial (in)
ii = Metric (mm)

Screws sold in multiples of 10

A DRILLING
B BORING
C REAMING
D BURNISHING
E THREADING
X SPECIALS

GEN3SYS XT Drill Inserts

16 Series | Diameter Range: 0.6299" - 0.6692" (16.00mm - 16.99mm)

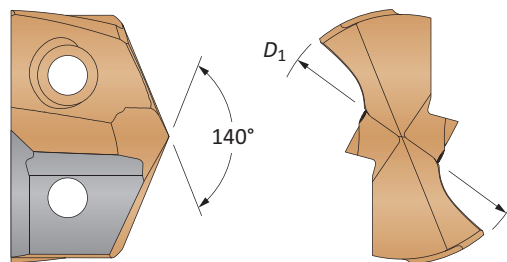
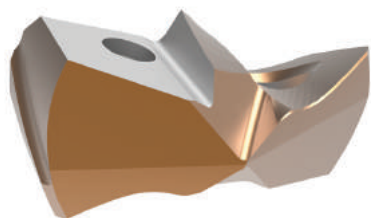

Carbide Substrate	Insert			Standard Part No.	Low Rake Part No.	Cast Iron Part No.	Stainless Part No.
	Fractional Equivalent	D ₁ inch	D ₁ mm				
C1 (K35)	-	0.6299	16.00	7C116P-16	7C116P-16LR	-	-
	-	0.6331	16.08	7C116P-16.08	7C116P-16.08LR	-	-
	41/64	0.6406	16.27	7C116P-.640	7C116P-.640LR	-	-
	-	0.6496	16.50	7C116P-16.5	7C116P-16.5LR	-	-
	21/32	0.6563	16.67	7C116P-0021	7C116P-0021LR	-	-
C2 (K20)	-	0.6299	16.00	7C216P-16	7C216P-16LR	7C216P-16CI	7C216P-16AS
	-	0.6331	16.08	7C216P-16.08	7C216P-16.08LR	7C216P-16.08CI	7C216P-16.08AS
	41/64	0.6406	16.27	7C216P-.640	7C216P-.640LR	7C216P-.640CI	7C216P-.640AS
	-	0.6496	16.50	7C216P-16.5	7C216P-16.5LR	7C216P-16.5CI	7C216P-16.5AS
	21/32	0.6563	16.67	7C216P-0021	7C216P-0021LR	7C216P-0021CI	7C216P-0021AS

Inserts sold in multiples of 1

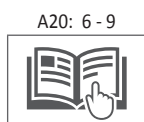
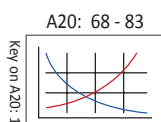



Sizes not shown are available upon request. When ordering, please follow the example below:	
Imperial:	0.5200", 13 series, C2 = use Part No. 7C213P-.5200
Metric:	13.20mm, 13 series, C2 = use Part No. 7C213P-13.20

GEN3SYS XT Standard Drill Insert Holders

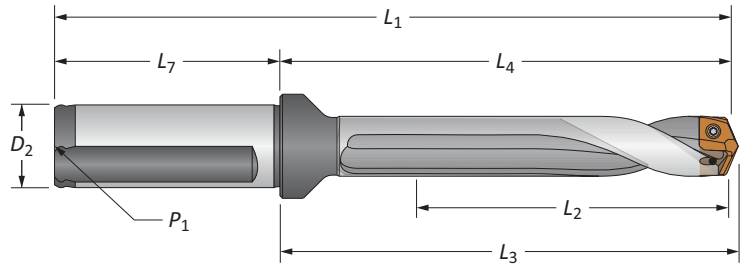
16 Series | Diameter Range: 0.6299" - 0.6692" (16.00mm - 16.99mm)





Straight and Helical

Flute	Length	Body				Shank				Flat	Part No.
		L ₂	L ₄	L ₃	L ₁	L ₇	D ₂	P ₁			
	3xD	2	3-13/64	3-5/16	5-15/64	2-1/32	3/4	1/8	YES	60316S-075F	
	5xD	3-11/32	4-17/32	4-21/32	6-9/16	2-1/32	3/4	1/8	YES	60516S-075F	
	7xD	4-11/16	5-7/8	5-63/64	7-29/32	2-1/32	3/4	1/8	YES	60716S-075F	
	Stub	13/16	2	2-7/64	4-1/32	2-1/32	3/4	1/8	YES	60116H-075F	
	3xD	2	3-13/64	3-5/16	5-15/64	2-1/32	3/4	1/8	YES	60316H-075F	
	3xD	2	3-13/64	3-5/16	5-15/64	2-1/32	3/4	1/8	NO	60316H-075C	
	5xD	3-11/32	4-17/32	4-21/32	6-9/16	2-1/32	3/4	1/8	YES	60516H-075F	
	5xD	3-11/32	4-17/32	4-21/32	6-9/16	2-1/32	3/4	1/8	NO	60516H-075C	
	7xD	4-11/16	5-7/8	5-63/64	7-29/32	2-1/32	3/4	1/8	YES	60716H-075F	
	7xD	4-11/16	5-7/8	5-63/64	7-29/32	2-1/32	3/4	1/8	NO	60716H-075C	
	3xD	50.8	81.3	84.2	131.3	50.0	20.0	1/8*	YES	60316S-20FM	
	5xD	85.0	115.1	118.2	165.1	50.0	20.0	1/8*	YES	60516S-20FM	
	7xD	119.0	149.2	152.0	199.2	50.0	20.0	1/8*	YES	60716S-20FM	
	Stub	21.0	50.8	53.7	100.8	50.0	20.0	1/8*	YES	60116H-20FM	
	3xD	50.8	81.3	84.2	131.3	50.0	20.0	1/8*	YES	60316H-20FM	
	3xD	50.8	81.3	84.2	131.3	50.0	20.0	1/8*	NO	60316H-20CM	
	5xD	85.0	115.1	118.2	165.1	50.0	20.0	1/8*	YES	60516H-20FM	
	5xD	85.0	115.1	118.2	165.1	50.0	20.0	1/8*	NO	60516H-20CM	
	7xD	119.0	149.2	152.0	199.2	50.0	20.0	1/8*	YES	60716H-20FM	
	7xD	119.0	149.2	152.0	199.2	50.0	20.0	1/8*	NO	60716H-20CM	

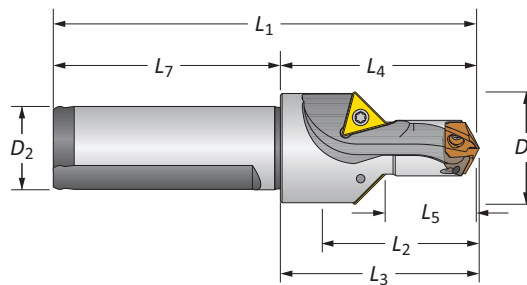



*Thread to BSP and ISO 7-1



Drill / Chamfer

Step	Body				Shank			Part No.	 Chamfer Insert	
	D ₅	L ₅	L ₂	L ₄	L ₃	L ₁	L ₇			D ₂
	1-1/16	61/64	1-19/64	2	2-7/64	4-1/32	2-1/32	3/4	60116C45-075F	TCMT-110204
	27.0	24.0	33.1	50.8	53.7	100.8	50.0	20.0	60116C45-20FM	TCMT-110204

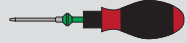
Connection Accessories

 Insert Screws	 Nylon Locking Screws	 Insert Driver	 Preset Torque Hand Driver	 Replacement Tips	Admissible Tightening Torque*
72556-IP8-1	72556N-IP8-1	8IP-8	8IP-8TL	8IP-8B	15.5 in-lbs (175 N-cm)

*Tightening torques are calculated with a friction coefficient of $\mu = 0.14$ and develop 90% of ultimate yield strength



Chamfer inserts sold separately in multiples of 10 | Screws sold in multiples of 10

 = Imperial (in)
 = Metric (mm)

GEN3SYS XT Pro Drill Inserts

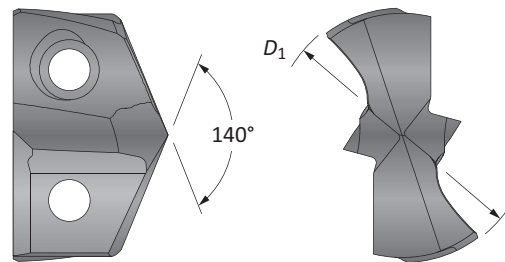
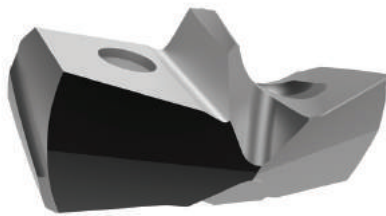
17 Series | Diameter Range: 0.6693" - 0.7086" (17.00mm - 17.99mm)



Fractional Equivalent	Insert				
	D_1 inch	D_1 mm	Part No. P	Part No. K	Part No. N
-	0.6693	17.00	XTP17-17.00	XTK17-17.00	XTN17-17.00
43/64	0.6719	17.07	XTP17-17.07	XTK17-17.07	XTN17-17.07
-	0.6732	17.10	XTP17-17.10	XTK17-17.10	XTN17-17.10
-	0.6772	17.20	XTP17-17.20	XTK17-17.20	XTN17-17.20
-	0.6811	17.30	XTP17-17.30	XTK17-17.30	XTN17-17.30
-	0.6850	17.40	XTP17-17.40	XTK17-17.40	XTN17-17.40
11/16	0.6875	17.46	XTP17-17.46	XTK17-17.46	XTN17-17.46
-	0.6890	17.50	XTP17-17.50	XTK17-17.50	XTN17-17.50
-	0.6929	17.60	XTP17-17.60	XTK17-17.60	XTN17-17.60
-	0.6969	17.70	XTP17-17.70	XTK17-17.70	XTN17-17.70
-	0.7008	17.80	XTP17-17.80	XTK17-17.80	XTN17-17.80
45/64	0.7031	17.86	XTP17-17.86	XTK17-17.86	XTN17-17.86
-	0.7047	17.90	XTP17-17.90	XTK17-17.90	XTN17-17.90

Inserts sold in multiples of 1

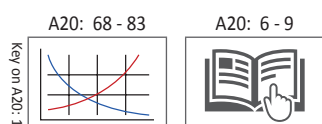



Sizes not shown are available upon request.	
When ordering, please follow the example below:	
Imperial:	0.5180", Steel, 13 series = use Part No. XTP13-13.16
Metric:	13.16mm, Steel, 13 series = use Part No. XTP13-13.16

GEN3SYS XT Pro Drill Insert Holders

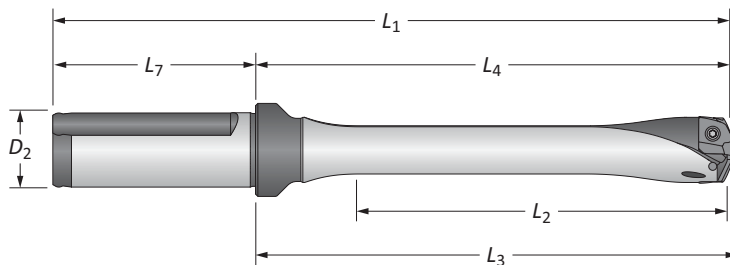
17 Series | Diameter Range: 0.6693" - 0.7086" (17.00mm - 17.99mm)



Flute	Body					Shank			Part No.
	Length	L ₂	L ₄	L ₃	L ₁	L ₇	D ₂	Flat	
i  Straight	3xD	2-1/8	3-19/64	3-27/64	5-21/64	2-1/32	3/4	YES	HXT0317S-075F
	3xD	2-1/8	3-19/64	3-27/64	5-21/64	2-1/32	3/4	NO	HXT0317S-075C
	5xD	3-35/64	4-23/32	4-27/32	6-3/4	2-1/32	3/4	YES	HXT0517S-075F
	5xD	3-35/64	4-23/32	4-27/32	6-3/4	2-1/32	3/4	NO	HXT0517S-075C
	7xD	4-61/64	6-9/64	6-1/4	8-11/64	2-1/32	3/4	YES	HXT0717S-075F
	7xD	4-61/64	6-9/64	6-1/4	8-11/64	2-1/32	3/4	NO	HXT0717S-075C
	10xD	7-5/64	8-17/64	8-3/8	10-19/64	2-1/32	3/4	YES	HXT1017S-075F
10xD	7-5/64	8-17/64	8-3/8	10-19/64	2-1/32	3/4	NO	HXT1017S-075C	
iii  Straight	3xD	54.0	83.8	86.9	133.8	50.0	20.0	YES	HXT0317S-20FM
	3xD	54.0	83.8	86.9	133.8	50.0	20.0	NO	HXT0317S-20CM
	5xD	90.0	119.8	122.9	169.8	50.0	20.0	YES	HXT0517S-20FM
	5xD	90.0	119.8	122.9	169.8	50.0	20.0	NO	HXT0517S-20CM
	7xD	125.8	156.0	158.9	206.0	50.0	20.0	YES	HXT0717S-20FM
	7xD	125.8	156.0	158.9	206.0	50.0	20.0	NO	HXT0717S-20CM
	10xD	179.8	209.9	212.8	259.9	50.0	20.0	YES	HXT1017S-20FM
	10xD	179.8	209.9	212.8	259.9	50.0	20.0	NO	HXT1017S-20CM

Connection Accessories

Insert Screws	Nylon Locking Screws	Insert Driver	Preset Torque Hand Driver	Replacement Tips	Admissible Tightening Torque*
72567-IP8-1	72567N-IP8-1	8IP-8	8IP-8TL	8IP-8B	15.5 in-lbs (175 N-cm)

*Tightening torques are calculated with a friction coefficient of $\mu = 0.14$ and develop 90% of ultimate yield strength

WARNING Refer to Speed and Feed charts for recommended adjustments to speeds and feeds. Refer to page A20: 86 for deep hole drilling guidelines in this section of the catalog. Visit www.alliedmachine.com/DeepHoleGuidelines for the most up-to-date information and procedures. Factory technical assistance is available for your specific applications through our Application Engineering Team.

i = Imperial (in)
iii = Metric (mm)

Screws sold in multiples of 10



GEN3SYS XT Drill Inserts

17 Series | Diameter Range: 0.6693" - 0.7086" (17.00mm - 17.99mm)

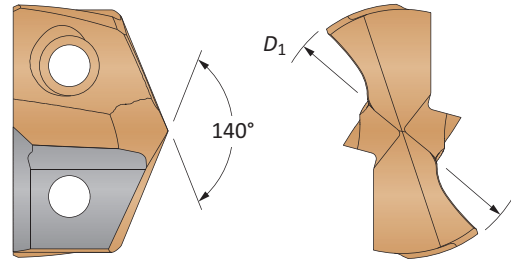
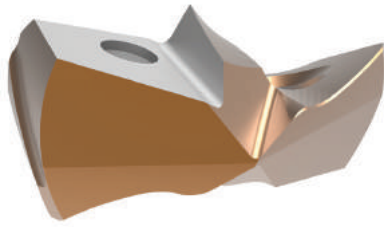

Carbide Substrate	Insert			Standard Part No.	Low Rake Part No.	Cast Iron Part No.	Stainless Part No.
	Fractional Equivalent	D_1 inch	D_1 mm				
C1 (K35)		0.6693	17.00	7C117P-17	7C117P-17LR	-	-
	43/64	0.6719	17.07	7C117P-.671	7C117P-.671LR	-	-
		0.6732	17.10	7C117P-17.1	7C117P-17.1LR	-	-
		0.6772	17.20	7C117P-17.2	7C117P-17.2LR	-	-
	11/16	0.6875	17.46	7C117P-0022	7C117P-0022LR	-	-
		0.6890	17.50	7C117P-17.5	7C117P-17.5LR	-	-
	45/64	0.7031	17.86	7C117P-.703	7C117P-.703LR	-	-
C2 (K20)		0.6693	17.00	7C217P-17	7C217P-17LR	7C217P-17CI	7C217P-17AS
	43/64	0.6719	17.07	7C217P-.671	7C217P-.671LR	7C217P-.671CI	7C217P-.671AS
		0.6732	17.10	7C217P-17.1	7C217P-17.1LR	7C217P-17.1CI	7C217P-17.1AS
		0.6772	17.20	7C217P-17.2	7C217P-17.2LR	7C217P-17.2CI	7C217P-17.2AS
	11/16	0.6875	17.46	7C217P-0022	7C217P-0022LR	7C217P-0022CI	7C217P-0022AS
		0.6890	17.50	7C217P-17.5	7C217P-17.5LR	7C217P-17.5CI	7C217P-17.5AS
		45/64	0.7031	17.86	7C217P-.703	7C217P-.703LR	7C217P-.703CI

Inserts sold in multiples of 1

A20: 68 - 83

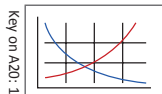

A20: 6 - 9



Key on A20: 1

Sizes not shown are available upon request.
When ordering, please follow the example below:

Imperial:	0.5200", 13 series, C2 = use Part No. 7C213P-.5200
Metric:	13.20mm, 13 series, C2 = use Part No. 7C213P-13.20

GEN3SYS XT Standard Drill Insert Holders

17 Series | Diameter Range: 0.6693" - 0.7086" (17.00mm - 17.99mm)

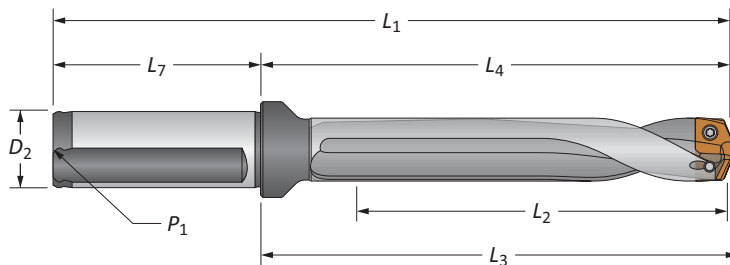

Straight and Helical

Flute	Length	Body				Shank				Flat	Part No.
		L ₂	L ₄	L ₃	L ₁	L ₇	D ₂	P ₁			
Straight	3xD	2-1/8	3-19/64	3-27/64	5-21/64	2-1/32	3/4	1/8	YES	60317S-075F	
	5xD	3-35/64	4-23/32	4-27/32	6-3/4	2-1/32	3/4	1/8	YES	60517S-075F	
	7xD	4-61/64	6-9/64	6-1/4	8-11/64	2-1/32	3/4	1/8	YES	60717S-075F	
Helical	Stub	13/16	1-63/64	2-7/64	4-1/64	2-1/32	3/4	1/8	YES	60117H-075F	
	3xD	2-1/8	3-19/64	3-27/64	5-21/64	2-1/32	3/4	1/8	YES	60317H-075F	
	3xD	2-1/8	3-19/64	3-27/64	5-21/64	2-1/32	3/4	1/8	NO	60317H-075C	
	5xD	3-35/64	4-23/32	4-27/32	6-3/4	2-1/32	3/4	1/8	YES	60517H-075F	
	5xD	3-35/64	4-23/32	4-27/32	6-3/4	2-1/32	3/4	1/8	NO	60517H-075C	
	7xD	4-61/64	6-9/64	6-1/4	8-11/64	2-1/32	3/4	1/8	YES	60717H-075F	
	7xD	4-61/64	6-9/64	6-1/4	8-11/64	2-1/32	3/4	1/8	NO	60717H-075C	
	Metric	3xD	54.0	83.8	86.9	133.8	50.0	20.0	1/8*	YES	60317S-20FM
5xD		90.0	119.8	122.9	169.8	50.0	20.0	1/8*	YES	60517S-20FM	
7xD		125.8	156.0	158.9	206.0	50.0	20.0	1/8*	YES	60717S-20FM	
Stub		20.6	50.5	53.5	100.5	50.0	20.0	1/8*	YES	60117H-20FM	
3xD		54.0	83.8	86.9	133.8	50.0	20.0	1/8*	YES	60317H-20FM	
3xD		54.0	83.8	86.9	133.8	50.0	20.0	1/8*	NO	60317H-20CM	
5xD		90.0	119.8	122.9	169.8	50.0	20.0	1/8*	YES	60517H-20FM	
5xD		90.0	119.8	122.9	169.8	50.0	20.0	1/8*	NO	60517H-20CM	
7xD		125.8	156.0	158.9	206.0	50.0	20.0	1/8*	YES	60717H-20FM	
7xD		125.8	156.0	158.9	206.0	50.0	20.0	1/8*	NO	60717H-20CM	

*Thread to BSP and ISO 7-1

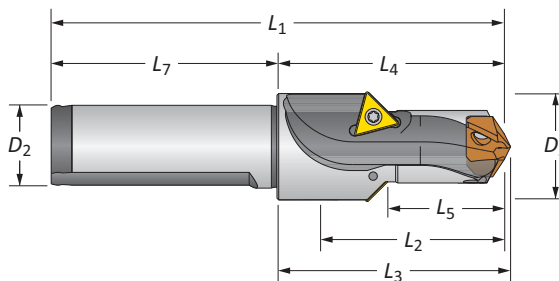
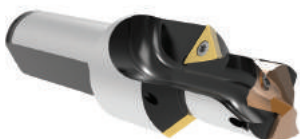

Drill / Chamfer

Step	Body				Shank			Part No.	Chamfer Insert
	D ₅	L ₅	L ₂	L ₄	L ₃	L ₁	L ₇		
1	1	1-5/16	1-63/64	2-7/64	4-1/64	2-1/32	3/4	60117C45-075F	TCMT-110204
25.4	25.5	33.3	50.5	53.4	100.5	50.0	20.0	60117C45-20FM	TCMT-110204

Connection Accessories

Insert Screws	Nylon Locking Screws	Insert Driver	Preset Torque Hand Driver	Replacement Tips	Admissible Tightening Torque*
72567-IP8-1	72567N-IP8-1	8IP-8	8IP-8TL	8IP-8B	15.5 in-lbs (175 N-cm)

*Tightening torques are calculated with a friction coefficient of $\mu = 0.14$ and develop 90% of ultimate yield strength



Chamfer inserts sold separately in multiples of 10 | Screws sold in multiples of 10

= Imperial (in)
 = Metric (mm)

GEN3SYS XT Pro Drill Inserts

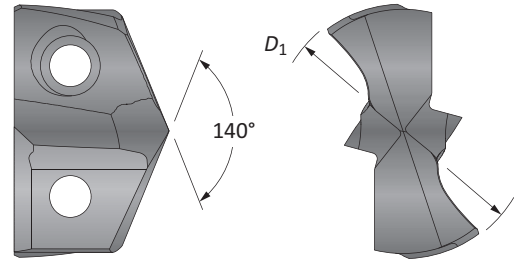
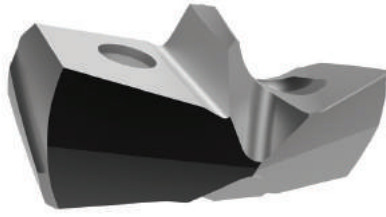
18 Series | Diameter Range: 0.7087" - 0.7873" (18.00mm - 19.99mm)



Fractional Equivalent	Insert				
	D_1 inch	D_1 mm	Part No. P	Part No. K	Part No. N
-	0.7087	18.00	XTP18-18.00	XTK18-18.00	XTN18-18.00
-	0.7126	18.10	XTP18-18.10	XTK18-18.10	XTN18-18.10
-	0.7165	18.20	XTP18-18.20	XTK18-18.20	XTN18-18.20
23/32	0.7188	18.26	XTP18-18.26	XTK18-18.26	XTN18-18.26
-	0.7205	18.30	XTP18-18.30	XTK18-18.30	XTN18-18.30
-	0.7244	18.40	XTP18-18.40	XTK18-18.40	XTN18-18.40
-	0.7283	18.50	XTP18-18.50	XTK18-18.50	XTN18-18.50
-	0.7323	18.60	XTP18-18.60	XTK18-18.60	XTN18-18.60
47/64	0.7344	18.65	XTP18-18.65	XTK18-18.65	XTN18-18.65
-	0.7362	18.70	XTP18-18.70	XTK18-18.70	XTN18-18.70
-	0.7402	18.80	XTP18-18.80	XTK18-18.80	XTN18-18.80
-	0.7441	18.90	XTP18-18.90	XTK18-18.90	XTN18-18.90
-	0.7480	19.00	XTP18-19.00	XTK18-19.00	XTN18-19.00
3/4	0.7500	19.05	XTP18-19.05	XTK18-19.05	XTN18-19.05
-	0.7520	19.10	XTP18-19.10	XTK18-19.10	XTN18-19.10
-	0.7559	19.20	XTP18-19.20	XTK18-19.20	XTN18-19.20
-	0.7580	19.25	XTP18-19.25	XTK18-19.25	XTN18-19.25
-	0.7598	19.30	XTP18-19.30	XTK18-19.30	XTN18-19.30
-	0.7638	19.40	XTP18-19.40	XTK18-19.40	XTN18-19.40
49/64	0.7656	19.45	XTP18-19.45	XTK18-19.45	XTN18-19.45
-	0.7677	19.50	XTP18-19.50	XTK18-19.50	XTN18-19.50
-	0.7717	19.60	XTP18-19.60	XTK18-19.60	XTN18-19.60
-	0.7756	19.70	XTP18-19.70	XTK18-19.70	XTN18-19.70
-	0.7795	19.80	XTP18-19.80	XTK18-19.80	XTN18-19.80
25/32	0.7813	19.84	XTP18-19.84	XTK18-19.84	XTN18-19.84
-	0.7835	19.90	XTP18-19.90	XTK18-19.90	XTN18-19.90

Inserts sold in multiples of 1

A20: 68 - 83

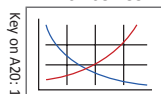

A20: 6 - 9



Sizes not shown are available upon request.

When ordering, please follow the example below:

Imperial:	0.5180", Steel, 13 series = use Part No. XTP13-13.16
Metric:	13.16mm, Steel, 13 series = use Part No. XTP13-13.16

GEN3SYS XT Pro Drill Insert Holders

18 Series | Diameter Range: 0.7087" - 0.7873" (18.00mm - 19.99mm)

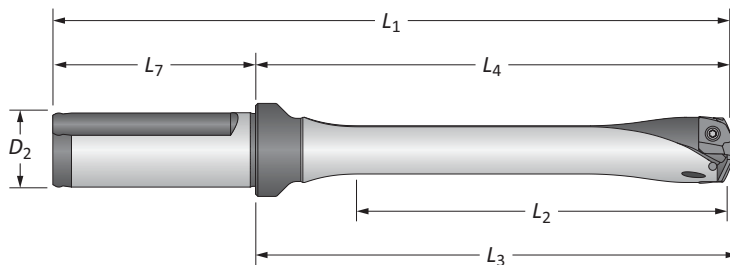

Flute	Body					Shank			Part No.
	Length	L ₂	L ₄	L ₃	L ₁	L ₇	D ₂	Flat	
i Straight	3xD	2-23/64	3-45/64	3-13/16	5-63/64	2-9/32	1	YES	HXT0318S-100F
	3xD	2-23/64	3-45/64	3-13/16	5-63/64	2-9/32	1	NO	HXT0318S-100C
	5xD	3-15/16	5-17/64	5-25/64	7-35/64	2-9/32	1	YES	HXT0518S-100F
	5xD	3-15/16	5-17/64	5-25/64	7-35/64	2-9/32	1	NO	HXT0518S-100C
	7xD	5-33/64	6-27/32	6-61/64	9-1/8	2-9/32	1	YES	HXT0718S-100F
	7xD	5-33/64	6-27/32	6-61/64	9-1/8	2-9/32	1	NO	HXT0718S-100C
	10xD	7-7/8	9-7/32	9-5/16	11-31/64	2-9/32	1	YES	HXT1018S-100F
10xD	7-7/8	9-7/32	9-5/16	11-31/64	2-9/32	1	NO	HXT1018S-100C	
ii Straight	3xD	60.0	94.0	96.8	150.0	56.0	25.0	YES	HXT0318S-25FM
	3xD	60.0	94.0	96.8	150.0	56.0	25.0	NO	HXT0318S-25CM
	5xD	100.0	133.7	136.8	189.7	56.0	25.0	YES	HXT0518S-25FM
	5xD	100.0	133.7	136.8	189.7	56.0	25.0	NO	HXT0518S-25CM
	7xD	140.0	173.4	176.8	229.4	56.0	25.0	YES	HXT0718S-25FM
	7xD	140.0	173.4	176.8	229.4	56.0	25.0	NO	HXT0718S-25CM
	10xD	199.9	234.1	236.7	290.1	56.0	25.0	YES	HXT1018S-25FM
	10xD	199.9	234.1	236.7	290.1	56.0	25.0	NO	HXT1018S-25CM

Connection Accessories

					Admissible Tightening Torque*
7375-IP9-1	7375N-IP9-1	8IP-9	8IP-9TL	8IP-9B	27.0 in-lbs (305 N-cm)

*Tightening torques are calculated with a friction coefficient of $\mu = 0.14$ and develop 90% of ultimate yield strength

⚠ WARNING Refer to Speed and Feed charts for recommended adjustments to speeds and feeds. Refer to page A20: 86 for deep hole drilling guidelines in this section of the catalog. Visit www.alliedmachine.com/DeepHoleGuidelines for the most up-to-date information and procedures. Factory technical assistance is available for your specific applications through our Application Engineering Team.

i = Imperial (in)
ii = Metric (mm)

Screws sold in multiples of 10



GEN3SYS XT Drill Inserts

18 Series | Diameter Range: 0.7087" - 0.7873" (18.00mm - 19.99mm)

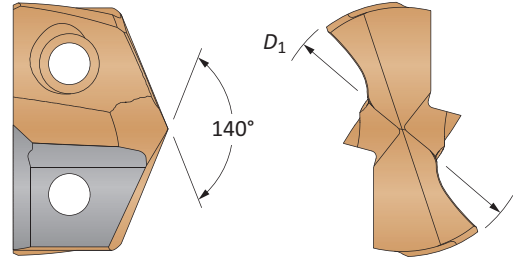
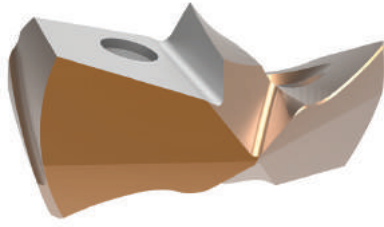

Carbide Substrate	Insert			Standard Part No.	Low Rake Part No.	Cast Iron Part No.	Stainless Part No.
	Fractional Equivalent	D_1 inch	D_1 mm				
C1 (K35)	-	0.7087	18.00	7C118P-18	7C118P-18LR	-	-
	23/32	0.7188	18.26	7C118P-0023	7C118P-0023LR	-	-
	-	0.7283	18.50	7C118P-18.5	7C118P-18.5LR	-	-
	47/64	0.7344	18.65	7C118P-.734	7C118P-.734LR	-	-
	-	0.7480	19.00	7C118P-19	7C118P-19LR	-	-
	3/4	0.7500	19.05	7C118P-0024	7C118P-0024LR	-	-
	-	0.7580	19.25	7C118P-.758	7C118P-.758LR	-	-
	49/64	0.7656	19.45	7C118P-.765	7C118P-.765LR	-	-
	-	0.7677	19.50	7C118P-19.5	7C118P-19.5LR	-	-
	-	0.7795	19.80	7C118P-19.8	7C118P-19.8LR	-	-
25/32	0.7813	19.85	7C118P-0025	7C118P-0025LR	-	-	
C2 (K20)	-	0.7087	18.00	7C218P-18	7C218P-18LR	7C218P-18CI	7C218P-18AS
	23/32	0.7188	18.26	7C218P-0023	7C218P-0023LR	7C218P-0023CI	7C218P-0023AS
	-	0.7283	18.50	7C218P-18.5	7C218P-18.5LR	7C218P-18.5CI	7C218P-18.5AS
	47/64	0.7344	18.65	7C218P-.734	7C218P-.734LR	7C218P-.734CI	7C218P-.734AS
	-	0.7480	19.00	7C218P-19	7C218P-19LR	7C218P-19CI	7C218P-19AS
	3/4	0.7500	19.05	7C218P-0024	7C218P-0024LR	7C218P-0024CI	7C218P-0024AS
	-	0.7580	19.25	7C218P-.758	7C218P-.758LR	7C218P-.758CI	7C218P-.758AS
	49/64	0.7656	19.45	7C218P-.765	7C218P-.765LR	7C218P-.765CI	7C218P-.765AS
	-	0.7677	19.50	7C218P-19.5	7C218P-19.5LR	7C218P-19.5CI	7C218P-19.5AS
	-	0.7795	19.80	7C218P-19.8	7C218P-19.8LR	7C218P-19.8CI	7C218P-19.8AS
25/32	0.7813	19.85	7C218P-0025	7C218P-0025LR	7C218P-0025CI	7C218P-0025AS	

Inserts sold in multiples of 1

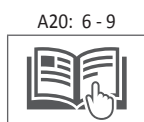
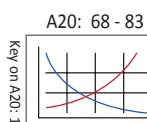

Sizes not shown are available upon request.	
When ordering, please follow the example below:	
Imperial:	0.5200", 13 series, C2 = use Part No. 7C213P-.5200
Metric:	13.20mm, 13 series, C2 = use Part No. 7C213P-13.20

GEN3SYS XT Standard Drill Insert Holders

18 Series | Diameter Range: 0.7087" - 0.7873" (18.00mm - 19.99mm)

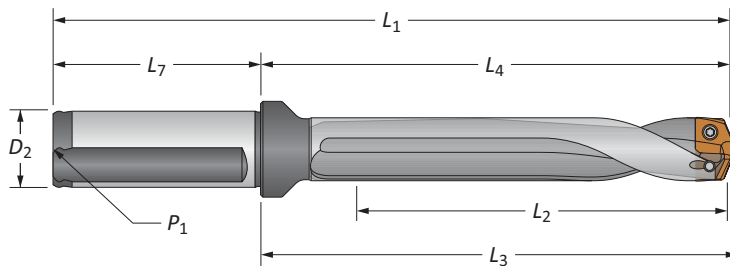

Straight and Helical

Flute	Length	Body				Shank				Flat	Part No.
		L ₂	L ₄	L ₃	L ₁	L ₇	D ₂	P ₁			
Straight	3xD	2-23/64	3-45/64	3-13/16	5-63/64	2-9/32	1	1/8	YES	60318S-100F	
	5xD	3-15/16	5-17/64	5-25/64	7-35/64	2-9/32	1	1/8	YES	60518S-100F	
	7xD	5-33/64	6-27/32	6-61/64	9-1/8	2-9/32	1	1/8	YES	60718S-100F	
Helical	Stub	7/8	2-13/64	2-5/16	4-31/64	2-9/32	1	1/8	YES	60118H-100F	
	3xD	2-23/64	3-45/64	3-13/16	5-63/64	2-9/32	1	1/8	YES	60318H-100F	
	3xD	2-23/64	3-45/64	3-13/16	5-63/64	2-9/32	1	1/8	NO	60318H-100C	
	5xD	3-15/16	5-17/64	5-25/64	7-35/64	2-9/32	1	1/8	YES	60518H-100F	
	5xD	3-15/16	5-17/64	5-25/64	7-35/64	2-9/32	1	1/8	NO	60518H-100C	
	7xD	5-33/64	6-27/32	6-61/64	9-1/8	2-9/32	1	1/8	YES	60718H-100F	
	7xD	5-33/64	6-27/32	6-61/64	9-1/8	2-9/32	1	1/8	NO	60718H-100C	
Straight	3xD	60.0	94.0	96.8	150.0	56.0	25.0	1/8*	YES	60318S-25FM	
	5xD	100.0	133.7	136.8	189.7	56.0	25.0	1/8*	YES	60518S-25FM	
	7xD	140.0	173.4	176.8	229.4	56.0	25.0	1/8*	YES	60718S-25FM	
	Stub	22.0	56.0	58.8	112.0	56.0	25.0	1/8*	YES	60118H-25FM	
	Helical	3xD	60.0	94.0	96.8	150.0	56.0	25.0	1/8*	YES	60318H-25FM
		3xD	60.0	94.0	96.8	150.0	56.0	25.0	1/8*	NO	60318H-25CM
		5xD	100.0	133.7	136.8	189.7	56.0	25.0	1/8*	YES	60518H-25FM
		5xD	100.0	133.7	136.8	189.7	56.0	25.0	1/8*	NO	60518H-25CM
		7xD	140.0	173.4	176.8	229.4	56.0	25.0	1/8*	YES	60718H-25FM
		7xD	140.0	173.4	176.8	229.4	56.0	25.0	1/8*	NO	60718H-25CM

*Thread to BSP and ISO 7-1

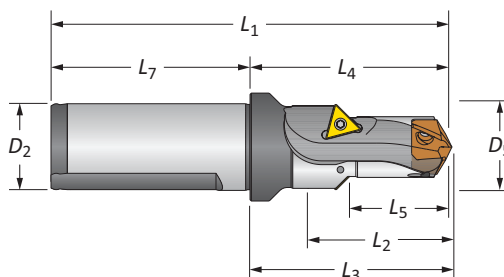

Drill / Chamfer

	Step		Body				Shank		Part No.	Chamfer Insert
	D ₅	L ₅	L ₂	L ₄	L ₃	L ₁	L ₇	D ₂		
i	63/64	1-1/16	1-25/64	2-13/64	2-5/16	4-31/64	2-9/32	1	60118C45-100F	TCMT-110204
m	25.1	27	35.2	56.0	58.8	112.0	56.0	25.0	60118C45-25FM	TCMT-110204

Connection Accessories

Insert Screws	Nylon Locking Screws	Insert Driver	Preset Torque Hand Driver	Replacement Tips	Admissible Tightening Torque*
7375-IP9-1	7375N-IP9-1	8IP-9	8IP-9TL	8IP-9B	27.0 in-lbs (305 N-cm)

*Tightening torques are calculated with a friction coefficient of $\mu = 0.14$ and develop 90% of ultimate yield strength

Chamfer inserts sold separately in multiples of 10 | Screws sold in multiples of 10



i = Imperial (in)
m = Metric (mm)

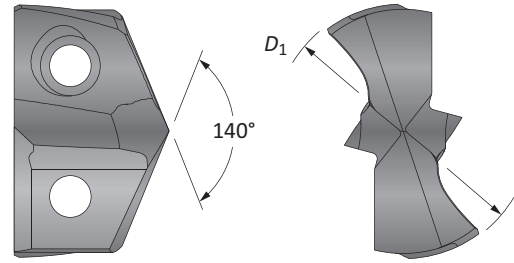
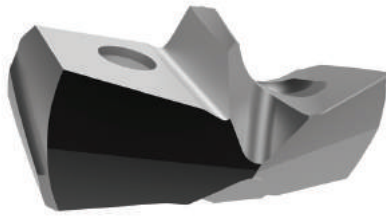

GEN3SYS XT Pro Drill Inserts

20 Series | Diameter Range: 0.7874" - 0.8660" (20.00mm - 21.99mm)



Fractional Equivalent	Insert				
	D_1 inch	D_1 mm	Part No. P	Part No. K	Part No. N
-	0.7874	20.00	XTP20-20.00	XTK20-20.00	XTN20-20.00
-	0.7913	20.10	XTP20-20.10	XTK20-20.10	XTN20-20.10
-	0.7953	20.20	XTP20-20.20	XTK20-20.20	XTN20-20.20
51/64	0.7969	20.24	XTP20-20.24	XTK20-20.24	XTN20-20.24
-	0.7992	20.30	XTP20-20.30	XTK20-20.30	XTN20-20.30
-	0.8031	20.40	XTP20-20.40	XTK20-20.40	XTN20-20.40
-	0.8071	20.50	XTP20-20.50	XTK20-20.50	XTN20-20.50
-	0.8110	20.60	XTP20-20.60	XTK20-20.60	XTN20-20.60
13/16	0.8125	20.64	XTP20-20.64	XTK20-20.64	XTN20-20.64
-	0.8150	20.70	XTP20-20.70	XTK20-20.70	XTN20-20.70
-	0.8189	20.80	XTP20-20.80	XTK20-20.80	XTN20-20.80
-	0.8228	20.90	XTP20-20.90	XTK20-20.90	XTN20-20.90
-	0.8268	21.00	XTP20-21.00	XTK20-21.00	XTN20-21.00
-	0.8307	21.10	XTP20-21.10	XTK20-21.10	XTN20-21.10
-	0.8346	21.20	XTP20-21.20	XTK20-21.20	XTN20-21.20
-	0.8386	21.30	XTP20-21.30	XTK20-21.30	XTN20-21.30
-	0.8425	21.40	XTP20-21.40	XTK20-21.40	XTN20-21.40
27/32	0.8438	21.43	XTP20-21.43	XTK20-21.43	XTN20-21.43
-	0.8465	21.50	XTP20-21.50	XTK20-21.50	XTN20-21.50
-	0.8504	21.60	XTP20-21.60	XTK20-21.60	XTN20-21.60
-	0.8543	21.70	XTP20-21.70	XTK20-21.70	XTN20-21.70
-	0.8583	21.80	XTP20-21.80	XTK20-21.80	XTN20-21.80
55/64	0.8594	21.83	XTP20-21.83	XTK20-21.83	XTN20-21.83
-	0.8622	21.90	XTP20-21.90	XTK20-21.90	XTN20-21.90

Inserts sold in multiples of 1

A20: 68 - 83

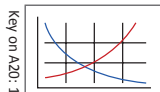

A20: 6 - 9



Sizes not shown are available upon request.

When ordering, please follow the example below:

Imperial:	0.5180", Steel, 13 series = use Part No. XTP13-13.16
Metric:	13.16mm, Steel, 13 series = use Part No. XTP13-13.16

GEN3SYS XT Pro Drill Insert Holders

20 Series | Diameter Range: 0.7874" - 0.8660" (20.00mm - 21.99mm)

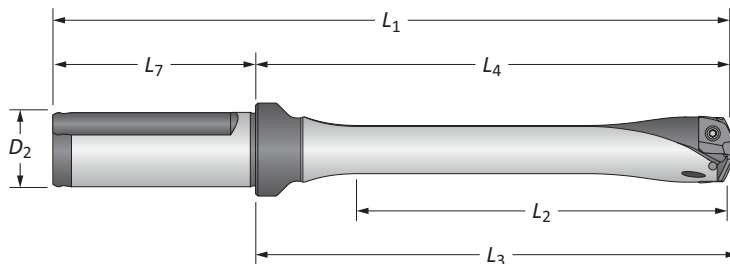

Flute	Body					Shank			Part No.
	Length	L ₂	L ₄	L ₃	L ₁	L ₇	D ₂	Flat	
i Straight	3xD	2-19/32	3-15/16	4-3/64	6-7/32	2-9/32	1	YES	HXT0320S-100F
	3xD	2-19/32	3-15/16	4-3/64	6-7/32	2-9/32	1	NO	HXT0320S-100C
	5xD	4-21/64	5-43/64	5-25/32	7-61/64	2-9/32	1	YES	HXT0520S-100F
	5xD	4-21/64	5-43/64	5-25/32	7-61/64	2-9/32	1	NO	HXT0520S-100C
	7xD	6-1/16	7-13/32	7-33/64	9-11/16	2-9/32	1	YES	HXT0720S-100F
	7xD	6-1/16	7-13/32	7-33/64	9-11/16	2-9/32	1	NO	HXT0720S-100C
	10xD	8-21/32	10	10-7/64	12-9/32	2-9/32	1	YES	HXT1020S-100F
10xD	8-21/32	10	10-7/64	12-9/32	2-9/32	1	NO	HXT1020S-100C	
ii Straight	3xD	66.0	100.0	102.9	156.0	56.0	25.0	YES	HXT0320S-25FM
	3xD	66.0	100.0	102.9	156.0	56.0	25.0	NO	HXT0320S-25CM
	5xD	110.0	144.0	146.9	200.0	56.0	25.0	YES	HXT0520S-25FM
	5xD	110.0	144.0	146.9	200.0	56.0	25.0	NO	HXT0520S-25CM
	7xD	153.9	187.0	190.9	243.0	56.0	25.0	YES	HXT0720S-25FM
	7xD	153.9	187.0	190.9	243.0	56.0	25.0	NO	HXT0720S-25CM
	10xD	219.9	254.0	256.8	310.0	56.0	25.0	YES	HXT1020S-25FM
	10xD	219.9	254.0	256.8	310.0	56.0	25.0	NO	HXT1020S-25CM

Connection Accessories

					Admissible Tightening Torque*
7375-IP9-1	7375N-IP9-1	8IP-9	8IP-9TL	8IP-9B	27.0 in-lbs (305 N-cm)

*Tightening torques are calculated with a friction coefficient of $\mu = 0.14$ and develop 90% of ultimate yield strength

WARNING Refer to Speed and Feed charts for recommended adjustments to speeds and feeds. Refer to page A20: 86 for deep hole drilling guidelines in this section of the catalog. Visit www.alliedmachine.com/DeepHoleGuidelines for the most up-to-date information and procedures. Factory technical assistance is available for your specific applications through our Application Engineering Team.

i = Imperial (in)
ii = Metric (mm)

Screws sold in multiples of 10



GEN3SYS XT Drill Inserts

20 Series | Diameter Range: 0.7874" - 0.8660" (20.00mm - 21.99mm)

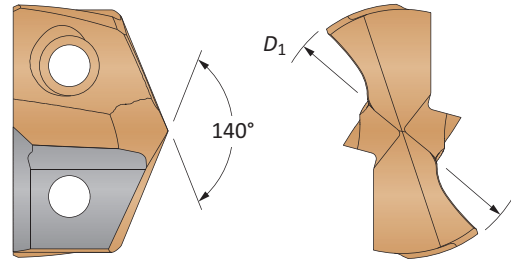
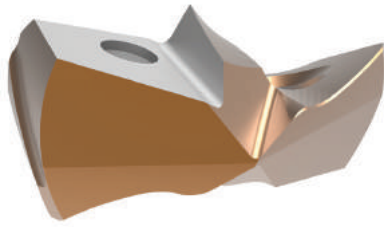

Carbide Substrate	Insert			Standard Part No.	Low Rake Part No.	Cast Iron Part No.	Stainless Part No.
	Fractional Equivalent	D ₁ inch	D ₁ mm				
C1 (K35)	-	0.7874	20.00	7C120P-20	7C120P-20LR	-	-
	51/64	0.7969	20.24	7C120P-.796	7C120P-.796LR	-	-
	-	0.8071	20.50	7C120P-20.5	7C120P-20.5LR	-	-
	13/16	0.8125	20.64	7C120P-0026	7C120P-0026LR	-	-
	-	0.8268	21.00	7C120P-21	7C120P-21LR	-	-
	27/32	0.8438	21.43	7C120P-0027	7C120P-0027LR	-	-
	-	0.8465	21.50	7C120P-21.5	7C120P-21.5LR	-	-
	55/64	0.8594	21.83	7C120P-.859	7C120P-.859LR	-	-
C2 (K20)	-	0.7874	20.00	7C220P-20	7C220P-20LR	7C220P-20CI	7C220P-20AS
	51/64	0.7969	20.24	7C220P-.796	7C220P-.796LR	7C220P-.796CI	7C220P-.796AS
	-	0.8071	20.50	7C220P-20.5	7C220P-20.5LR	7C220P-20.5CI	7C220P-20.5AS
	13/16	0.8125	20.64	7C220P-0026	7C220P-0026LR	7C220P-0026CI	7C220P-0026AS
	-	0.8268	21.00	7C220P-21	7C220P-21LR	7C220P-21CI	7C220P-21AS
	27/32	0.8438	21.43	7C220P-0027	7C220P-0027LR	7C220P-0027CI	7C220P-0027AS
	-	0.8465	21.50	7C220P-21.5	7C220P-21.5LR	7C220P-21.5CI	7C220P-21.5AS
	55/64	0.8594	21.83	7C220P-.859	7C220P-.859LR	7C220P-.859CI	7C220P-.859AS

Inserts sold in multiples of 1

A20: 68 - 83

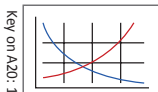

A20: 6 - 9



Key on A20: 1

Sizes not shown are available upon request.
When ordering, please follow the example below:



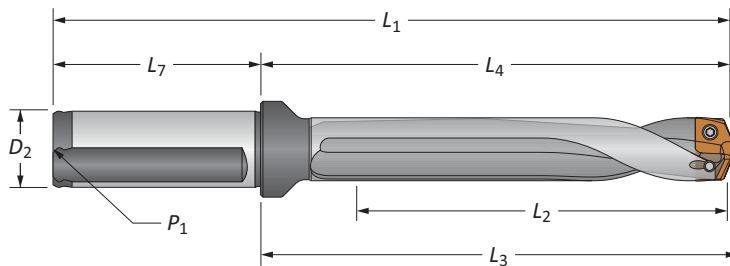

Imperial:	0.5200", 13 series, C2 = use Part No. 7C213P-.5200
Metric:	13.20mm, 13 series, C2 = use Part No. 7C213P-13.20

GEN3SYS XT Standard Drill Insert Holders

20 Series | Diameter Range: 0.7874" - 0.8660" (20.00mm - 21.99mm)



Straight and Helical

Flute	Length	Body				Shank				Flat	Part No.
		L ₂	L ₄	L ₃	L ₁	L ₇	D ₂	P ₁			
	3xD	2-19/32	3-15/16	4-3/64	6-7/32	2-9/32	1	1/8	YES	60320S-100F	
	5xD	4-21/64	5-43/64	5-25/32	7-61/64	2-9/32	1	1/8	YES	60520S-100F	
	7xD	6-1/16	7-13/32	7-33/64	9-11/16	2-9/32	1	1/8	YES	60720S-100F	
	Stub	15/16	2-17/64	2-3/8	4-35/64	2-9/32	1	1/8	YES	60120H-100F	
	3xD	2-19/32	3-15/16	4-3/64	6-7/32	2-9/32	1	1/8	YES	60320H-100F	
	3xD	2-19/32	3-15/16	4-3/64	6-7/32	2-9/32	1	1/8	NO	60320H-100C	
	5xD	4-21/64	5-43/64	5-25/32	7-61/64	2-9/32	1	1/8	YES	60520H-100F	
	5xD	4-21/64	5-43/64	5-25/32	7-61/64	2-9/32	1	1/8	NO	60520H-100C	
	7xD	6-1/16	7-13/32	7-33/64	9-11/16	2-9/32	1	1/8	YES	60720H-100F	
	7xD	6-1/16	7-13/32	7-33/64	9-11/16	2-9/32	1	1/8	NO	60720H-100C	
	3xD	66.0	100.0	102.9	156.0	56.0	25.0	1/8*	YES	60320S-25FM	
	5xD	110.0	144.0	146.9	200.0	56.0	25.0	1/8*	YES	60520S-25FM	
	7xD	153.9	187.0	190.9	243.0	56.0	25.0	1/8*	YES	60720S-25FM	
	Stub	24.0	57.6	60.4	113.6	56.0	25.0	1/8*	YES	60120H-25FM	
	3xD	66.0	100.0	102.9	156.0	56.0	25.0	1/8*	YES	60320H-25FM	
	3xD	66.0	100.0	102.9	156.0	56.0	25.0	1/8*	NO	60320H-25CM	
	5xD	110.0	144.0	146.9	200.0	56.0	25.0	1/8*	YES	60520H-25FM	
	5xD	110.0	144.0	146.9	200.0	56.0	25.0	1/8*	NO	60520H-25CM	
	7xD	153.9	187.0	190.9	243.0	56.0	25.0	1/8*	YES	60720H-25FM	
	7xD	153.9	187.0	190.9	243.0	56.0	25.0	1/8*	NO	60720H-25CM	



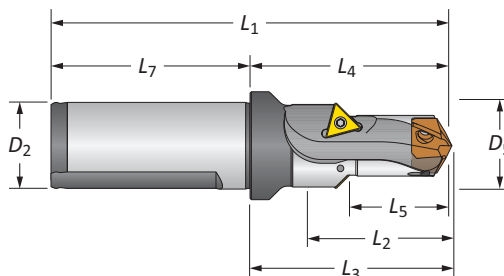

*Thread to BSP and ISO 7-1



Drill / Chamfer

Step	Body				Shank			Part No.	
	D ₅	L ₅	L ₂	L ₄	L ₃	L ₁	L ₇		
i 1-5/64	1-3/16	1-29/64	2-17/64	2-3/8	4-35/64	2-9/32	1	60120C45-100F	TCMT-110204
m 27.2	30.0	37.1	57.6	60.4	113.6	56.0	25.0	60120C45-25FM	TCMT-110204

Connection Accessories

					Admissible Tightening Torque*
7375-IP9-1	7375N-IP9-1	8IP-9	8IP-9TL	8IP-9B	27.0 in-lbs (305 N-cm)

*Tightening torques are calculated with a friction coefficient of $\mu = 0.14$ and develop 90% of ultimate yield strength



Chamfer inserts sold separately in multiples of 10 | Screws sold in multiples of 10

i = Imperial (in)
m = Metric (mm)

GEN3SYS XT Pro Drill Inserts

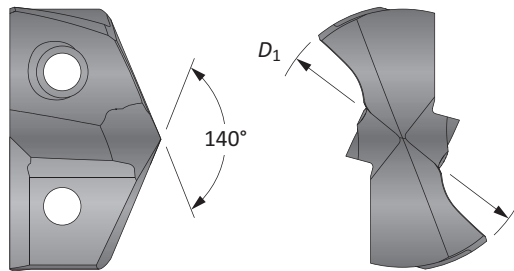
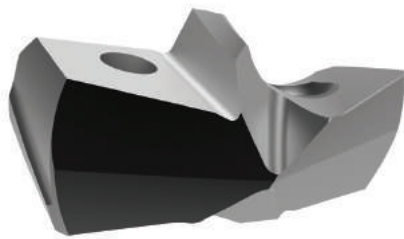
22 Series | Diameter Range: 0.8661" - 0.9448" (22.00mm - 23.99mm)



Fractional Equivalent	Insert				
	D_1 inch	D_1 mm	Part No. P	Part No. K	Part No. N
-	0.8661	22.00	XTP22-22.00	XTK22-22.00	XTN22-22.00
-	0.8701	22.10	XTP22-22.10	XTK22-22.10	XTN22-22.10
-	0.8740	22.20	XTP22-22.20	XTK22-22.20	XTN22-22.20
7/8	0.8750	22.23	XTP22-22.23	XTK22-22.23	XTN22-22.23
-	0.8780	22.30	XTP22-22.30	XTK22-22.30	XTN22-22.30
-	0.8819	22.40	XTP22-22.40	XTK22-22.40	XTN22-22.40
-	0.8858	22.50	XTP22-22.50	XTK22-22.50	XTN22-22.50
57/64	0.8906	22.62	XTP22-22.62	XTK22-22.62	XTN22-22.62
-	0.8937	22.70	XTP22-22.70	XTK22-22.70	XTN22-22.70
-	0.8976	22.80	XTP22-22.80	XTK22-22.80	XTN22-22.80
-	0.9016	22.90	XTP22-22.90	XTK22-22.90	XTN22-22.90
-	0.9055	23.00	XTP22-23.00	XTK22-23.00	XTN22-23.00
29/32	0.9063	23.02	XTP22-23.02	XTK22-23.02	XTN22-23.02
-	0.9094	23.10	XTP22-23.10	XTK22-23.10	XTN22-23.10
-	0.9134	23.20	XTP22-23.20	XTK22-23.20	XTN22-23.20
-	0.9173	23.30	XTP22-23.30	XTK22-23.30	XTN22-23.30
59/64	0.9219	23.42	XTP22-23.42	XTK22-23.42	XTN22-23.42
-	0.9252	23.50	XTP22-23.50	XTK22-23.50	XTN22-23.50
-	0.9291	23.60	XTP22-23.60	XTK22-23.60	XTN22-23.60
-	0.9331	23.70	XTP22-23.70	XTK22-23.70	XTN22-23.70
15/16	0.9375	23.81	XTP22-23.81	XTK22-23.81	XTN22-23.81
-	0.9409	23.90	XTP22-23.90	XTK22-23.90	XTN22-23.90

Inserts sold in multiples of 1

A20: 68 - 83

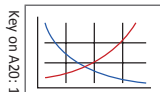

A20: 6 - 9



Sizes not shown are available upon request.
When ordering, please follow the example below:

Imperial:	0.5180", Steel, 13 series = use Part No. XTP13-13.16
Metric:	13.16mm, Steel, 13 series = use Part No. XTP13-13.16

GEN3SYS XT Pro Drill Insert Holders

22 Series | Diameter Range: 0.8661" - 0.9448" (22.00mm - 23.99mm)

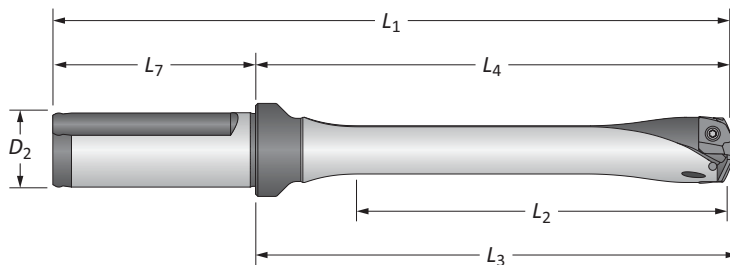

Flute	Body					Shank			Part No.
	Length	L ₂	L ₄	L ₃	L ₁	L ₇	D ₂	Flat	
i 	3xD	2-53/64	4-9/64	4-17/64	6-27/64	2-9/32	1	YES	HXT0322S-100F
	3xD	2-53/64	4-9/64	4-17/64	6-27/64	2-9/32	1	NO	HXT0322S-100C
	5xD	4-23/32	6-1/32	6-5/32	8-5/16	2-9/32	1	YES	HXT0522S-100F
	5xD	4-23/32	6-1/32	6-5/32	8-5/16	2-9/32	1	NO	HXT0522S-100C
	7xD	6-39/64	7-59/64	8-3/64	10-13/64	2-9/32	1	YES	HXT0722S-100F
	7xD	6-39/64	7-59/64	8-3/64	10-13/64	2-9/32	1	NO	HXT0722S-100C
	10xD	9-7/16	10-3/4	10-7/8	13-1/32	2-9/32	1	YES	HXT1022S-100F
10xD	9-7/16	10-3/4	10-7/8	13-1/32	2-9/32	1	NO	HXT1022S-100C	
m 	3xD	72.0	105.1	108.3	161.1	56.0	25.0	YES	HXT0322S-25FM
	3xD	72.0	105.1	108.3	161.1	56.0	25.0	NO	HXT0322S-25CM
	5xD	120.0	153.2	156.2	209.2	56.0	25.0	YES	HXT0522S-25FM
	5xD	120.0	153.2	156.2	209.2	56.0	25.0	NO	HXT0522S-25CM
	7xD	167.9	201.2	204.2	257.2	56.0	25.0	YES	HXT0722S-25FM
	7xD	167.9	201.2	204.2	257.2	56.0	25.0	NO	HXT0722S-25CM
	10xD	239.9	273.0	276.2	329.0	56.0	25.0	YES	HXT1022S-25FM
	10xD	239.9	273.0	276.2	329.0	56.0	25.0	NO	HXT1022S-25CM

Connection Accessories

					Admissible Tightening Torque*
739-IP9-1	739N-IP9-1	8IP-9	8IP-9TL	8IP-9B	27.0 in-lbs (305 N-cm)

*Tightening torques are calculated with a friction coefficient of $\mu = 0.14$ and develop 90% of ultimate yield strength

WARNING Refer to Speed and Feed charts for recommended adjustments to speeds and feeds. Refer to page A20: 86 for deep hole drilling guidelines in this section of the catalog. Visit www.alliedmachine.com/DeepHoleGuidelines for the most up-to-date information and procedures. Factory technical assistance is available for your specific applications through our Application Engineering Team.

i = Imperial (in)
m = Metric (mm)

Screws sold in multiples of 10

GEN3SYS XT Drill Inserts

22 Series | Diameter Range: 0.8661" - 0.9448" (22.00mm - 23.99mm)

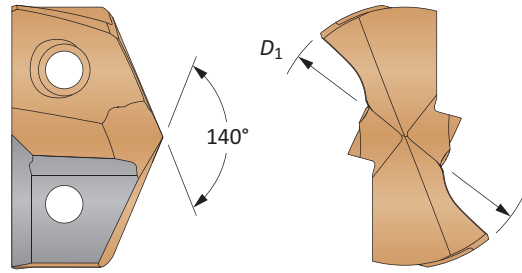
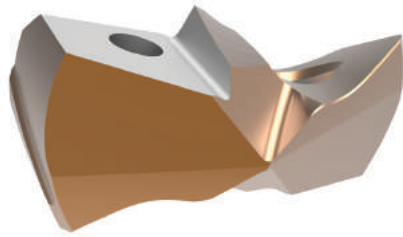

Carbide Substrate	Insert			Standard Part No.	Low Rake Part No.	Cast Iron Part No.	Stainless Part No.
	Fractional Equivalent	D_1 inch	D_1 mm				
C1 (K35)		0.8661	22.00	7C122P-22	7C122P-22LR	-	-
	7/8	0.8750	22.23	7C122P-0028	7C122P-0028LR	-	-
	57/64	0.8906	22.61	7C122P-.890	7C122P-.890LR	-	-
		0.9055	23.00	7C122P-23	7C122P-23LR	-	-
	29/32	0.9063	23.02	7C122P-0029	7C122P-0029LR	-	-
	59/64	0.9219	23.42	7C122P-.921	7C122P-.921LR	-	-
	0.9375	23.81	7C122P-0030	7C122P-0030LR	-	-	
C2 (K20)		0.8661	22.00	7C222P-22	7C222P-22LR	7C222P-22CI	7C222P-22AS
	7/8	0.8750	22.23	7C222P-0028	7C222P-0028LR	7C222P-0028CI	7C222P-0028AS
	57/64	0.8906	22.61	7C222P-.890	7C222P-.890LR	7C222P-.890CI	7C222P-.890AS
		0.9055	23.00	7C222P-23	7C222P-23LR	7C222P-23CI	7C222P-23AS
	29/32	0.9063	23.02	7C222P-0029	7C222P-0029LR	7C222P-0029CI	7C222P-0029AS
	59/64	0.9219	23.42	7C222P-.921	7C222P-.921LR	7C222P-.921CI	7C222P-.921AS
	0.9375	23.81	7C222P-0030	7C222P-0030LR	7C222P-0030CI	7C222P-0030AS	

Inserts sold in multiples of 1

A20: 68 - 83

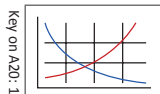

A20: 6 - 9



Sizes not shown are available upon request.
When ordering, please follow the example below:

Imperial:	0.5200", 13 series, C2 = use Part No. 7C213P-.5200
Metric:	13.20mm, 13 series, C2 = use Part No. 7C213P-13.20

GEN3SYS XT Standard Drill Insert Holders

22 Series | Diameter Range: 0.8661" - 0.9448" (22.00mm - 23.99mm)

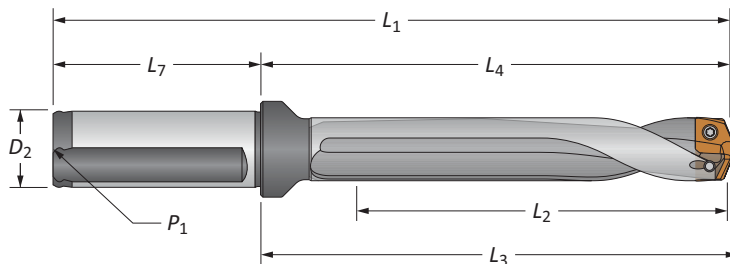

Straight and Helical

Flute	Length	Body				Shank				Flat	Part No.
		L ₂	L ₄	L ₃	L ₁	L ₇	D ₂	P ₁			
	3xD	2-53/64	4-9/64	4-17/64	6-27/64	2-9/32	1	1/8	YES	60322S-100F	
	5xD	4-23/32	6-1/32	6-5/32	8-5/16	2-9/32	1	1/8	YES	60522S-100F	
	7xD	6-39/64	7-59/64	8-3/64	10-13/64	2-9/32	1	1/8	YES	60722S-100F	
	Stub	1-1/16	2-23/64	2-31/64	4-41/64	2-9/32	1	1/8	YES	60122H-100F	
	3xD	2-53/64	4-9/64	4-17/64	6-27/64	2-9/32	1	1/8	YES	60322H-100F	
	3xD	2-53/64	4-9/64	4-17/64	6-27/64	2-9/32	1	1/8	NO	60322H-100C	
	5xD	4-23/32	6-1/32	6-5/32	8-5/16	2-9/32	1	1/8	YES	60522H-100F	
	5xD	4-23/32	6-1/32	6-5/32	8-5/16	2-9/32	1	1/8	NO	60522H-100C	
	7xD	6-39/64	7-59/64	8-3/64	10-13/64	2-9/32	1	1/8	YES	60722H-100F	
	7xD	6-39/64	7-59/64	8-3/64	10-13/64	2-9/32	1	1/8	NO	60722H-100C	
	3xD	72.0	105.1	108.3	161.1	56.0	25.0	1/8*	YES	60322S-25FM	
	5xD	120.0	153.2	156.2	209.2	56.0	25.0	1/8*	YES	60522S-25FM	
	7xD	167.9	201.2	204.2	257.2	56.0	25.0	1/8*	YES	60722S-25FM	
	Stub	27.0	60.1	63.0	116.1	56.0	25.0	1/8*	YES	60122H-25FM	
	3xD	72.0	105.1	108.3	161.1	56.0	25.0	1/8*	YES	60322H-25FM	
	3xD	72.0	105.1	108.3	161.1	56.0	25.0	1/8*	NO	60322H-25CM	
	5xD	120.0	153.2	156.2	209.2	56.0	25.0	1/8*	YES	60522H-25FM	
	5xD	120.0	153.2	156.2	209.2	56.0	25.0	1/8*	NO	60522H-25CM	
	7xD	167.9	201.2	204.2	257.2	56.0	25.0	1/8*	YES	60722H-25FM	
	7xD	167.9	201.2	204.2	257.2	56.0	25.0	1/8*	NO	60722H-25CM	

*Thread to BSP and ISO 7-1

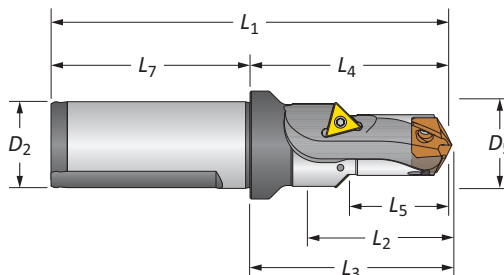

Drill / Chamfer

Step	Body				Shank			Part No.		Chamfer Insert
	D ₅	L ₅	L ₂	L ₄	L ₃	L ₁	L ₇			
i 1-9/64	1-19/64	1-19/32	2-23/64	2-31/64	4-41/64	2-9/32	1	60122C45-100F	TCMT-110204	
m 29.0	33.0	40.5	60.0	63.0	116.0	56.0	25.0	60122C45-25FM	TCMT-110204	

Connection Accessories

					Admissible Tightening Torque*
739-IP9-1	739N-IP9-1	8IP-9	8IP-9TL	8IP-9B	27.0 in-lbs (305 N-cm)

*Tightening torques are calculated with a friction coefficient of $\mu = 0.14$ and develop 90% of ultimate yield strength



Chamfer inserts sold separately in multiples of 10 | Screws sold in multiples of 10

i = Imperial (in)
m = Metric (mm)

GEN3SYS XT Pro Drill Inserts

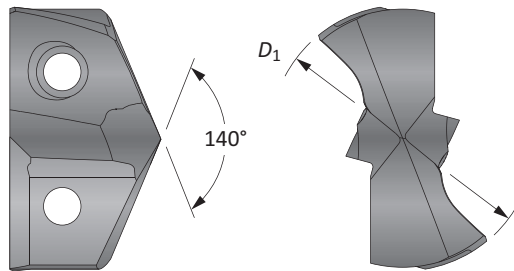
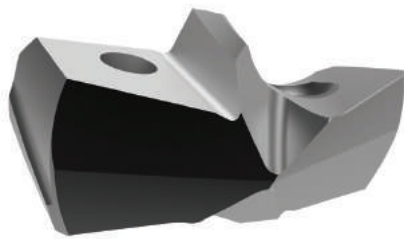
24 Series | Diameter Range: 0.9449" - 1.0235" (24.00mm - 25.99mm)



Fractional Equivalent	Insert				
	D_1 inch	D_1 mm	Part No. P	Part No. K	Part No. N
-	0.9449	24.00	XTP24-24.00	XTK24-24.00	XTN24-24.00
-	0.9488	24.10	XTP24-24.10	XTK24-24.10	XTN24-24.10
-	0.9528	24.20	XTP24-24.20	XTK24-24.20	XTN24-24.20
-	0.9567	24.30	XTP24-24.30	XTK24-24.30	XTN24-24.30
-	0.9606	24.40	XTP24-24.40	XTK24-24.40	XTN24-24.40
-	0.9646	24.50	XTP24-24.50	XTK24-24.50	XTN24-24.50
31/32	0.9688	24.61	XTP24-24.61	XTK24-24.61	XTN24-24.61
-	0.9724	24.70	XTP24-24.70	XTK24-24.70	XTN24-24.70
-	0.9764	24.80	XTP24-24.80	XTK24-24.80	XTN24-24.80
-	0.9803	24.90	XTP24-24.90	XTK24-24.90	XTN24-24.90
63/64	0.9843	25.00	XTP24-25.00	XTK24-25.00	XTN24-25.00
-	0.9882	25.10	XTP24-25.10	XTK24-25.10	XTN24-25.10
-	0.9921	25.20	XTP24-25.20	XTK24-25.20	XTN24-25.20
-	0.9961	25.30	XTP24-25.30	XTK24-25.30	XTN24-25.30
1	1.0000	25.40	XTP24-25.40	XTK24-25.40	XTN24-25.40
-	1.0039	25.50	XTP24-25.50	XTK24-25.50	XTN24-25.50
-	1.0080	25.60	XTP24-25.60	XTK24-25.60	XTN24-25.60
-	1.0118	25.70	XTP24-25.70	XTK24-25.70	XTN24-25.70
1-1/64	1.0150	25.78	XTP24-25.78	XTK24-25.78	XTN24-25.78
-	1.0197	25.90	XTP24-25.90	XTK24-25.90	XTN24-25.90

Inserts sold in multiples of 1

A20: 68 - 83

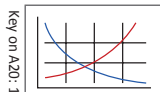

A20: 6 - 9



Sizes not shown are available upon request.

When ordering, please follow the example below:

Imperial:	0.5180", Steel, 13 series = use Part No. XTP13-13.16
Metric:	13.16mm, Steel, 13 series = use Part No. XTP13-13.16

GEN3SYS XT Pro Drill Insert Holders

24 Series | Diameter Range: 0.9449" - 1.0235" (24.00mm - 25.99mm)

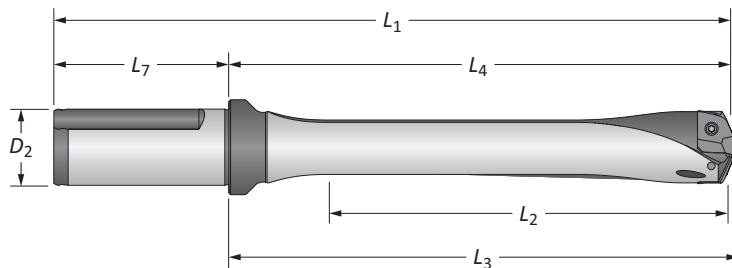

Flute	Body					Shank			Part No.
	Length	L ₂	L ₄	L ₃	L ₁	L ₇	D ₂	Flat	
i 	3xD	3-1/16	4-31/64	4-19/32	6-49/64	2-9/32	1	YES	HXT0324S-100F
	3xD	3-1/16	4-31/64	4-19/32	6-49/64	2-9/32	1	NO	HXT0324S-100C
	5xD	5-7/64	6-17/32	6-41/64	8-13/16	2-9/32	1	YES	HXT0524S-100F
	5xD	5-7/64	6-17/32	6-41/64	8-13/16	2-9/32	1	NO	HXT0524S-100C
	7xD	7-5/32	8-37/64	8-11/16	10-55/64	2-9/32	1	YES	HXT0724S-100F
	7xD	7-5/32	8-37/64	8-11/16	10-55/64	2-9/32	1	NO	HXT0724S-100C
	10xD	10-15/64	11-41/64	11-49/64	13-59/64	2-9/32	1	YES	HXT1024S-100F
10xD	10-15/64	11-41/64	11-49/64	13-59/64	2-9/32	1	NO	HXT1024S-100C	
ii 	3xD	78.0	113.9	116.8	169.9	56.0	25.0	YES	HXT0324S-25FM
	3xD	78.0	113.9	116.8	169.9	56.0	25.0	NO	HXT0324S-25CM
	5xD	130.0	165.9	168.7	221.9	56.0	25.0	YES	HXT0524S-25FM
	5xD	130.0	165.9	168.7	221.9	56.0	25.0	NO	HXT0524S-25CM
	7xD	181.9	217.9	220.7	273.9	56.0	25.0	YES	HXT0724S-25FM
	7xD	181.9	217.9	220.7	273.9	56.0	25.0	NO	HXT0724S-25CM
	10xD	259.9	295.7	298.7	351.7	56.0	25.0	YES	HXT1024S-25FM
	10xD	259.9	295.7	298.7	351.7	56.0	25.0	NO	HXT1024S-25CM

Connection Accessories

					Admissible Tightening Torque*
739-IP9-1	739N-IP9-1	8IP-9	8IP-9TL	8IP-9B	27.0 in-lbs (305 N-cm)

*Tightening torques are calculated with a friction coefficient of $\mu = 0.14$ and develop 90% of ultimate yield strength

WARNING Refer to Speed and Feed charts for recommended adjustments to speeds and feeds. Refer to page A20: 86 for deep hole drilling guidelines in this section of the catalog. Visit www.alliedmachine.com/DeepHoleGuidelines for the most up-to-date information and procedures. Factory technical assistance is available for your specific applications through our Application Engineering Team.

i = Imperial (in)
 ii = Metric (mm)





Screws sold in multiples of 10

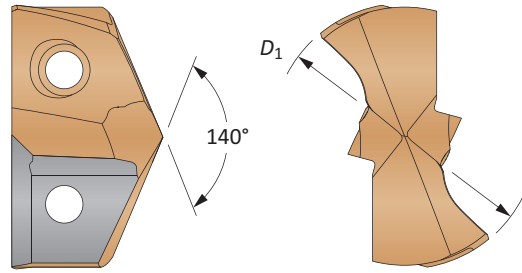
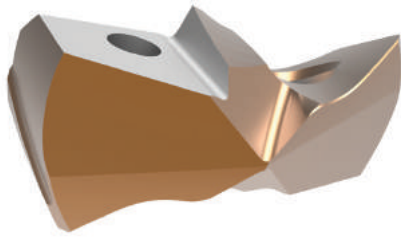

GEN3SYS XT Drill Inserts

24 Series | Diameter Range: 0.9449" - 1.0235" (24.00mm - 25.99mm)



Carbide Substrate	Insert			 Standard Part No.	 Low Rake Part No.	 Cast Iron Part No.	 Stainless Part No.
	Fractional Equivalent	D_1 inch	D_1 mm				
C1 (K35)	-	0.9449	24.00	7C124P-24	7C124P-24LR	-	-
	31/32	0.9688	24.61	7C124P-0031	7C124P-0031LR	-	-
	63/64	0.9843	25.00	7C124P-25	7C124P-25LR	-	-
	1	1.0000	25.40	7C124P-0100	7C124P-0100LR	-	-
	-	1.0080	25.60	7C124P-1.008	7C124P-1.008LR	-	-
	1-1/64	1.0156	25.78	7C124P-1.015	7C124P-1.015LR	-	-
C2 (K20)	-	0.9449	24.00	7C224P-24	7C224P-24LR	7C224P-24CI	7C224P-24AS
	31/32	0.9688	24.61	7C224P-0031	7C224P-0031LR	7C224P-0031CI	7C224P-0031AS
	63/64	0.9843	25.00	7C224P-25	7C224P-25LR	7C224P-25CI	7C224P-25AS
	1	1.0000	25.40	7C224P-0100	7C224P-0100LR	7C224P-0100CI	7C224P-0100AS
	-	1.0080	25.60	7C224P-1.008	7C224P-1.008LR	7C224P-1.008CI	7C224P-1.008AS
	1-1/64	1.0156	25.78	7C224P-1.015	7C224P-1.015LR	7C224P-1.015CI	7C224P-1.015AS

Inserts sold in multiples of 1

A20: 68 - 83

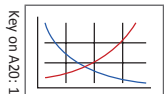

A20: 6 - 9



Sizes not shown are available upon request.
When ordering, please follow the example below:

Imperial:	0.5200", 13 series, C2 = use Part No. 7C213P-.5200
Metric:	13.20mm, 13 series, C2 = use Part No. 7C213P-13.20

GEN3SYS XT Standard Drill Insert Holders

24 Series | Diameter Range: 0.9449" - 1.0235" (24.00mm - 25.99mm)

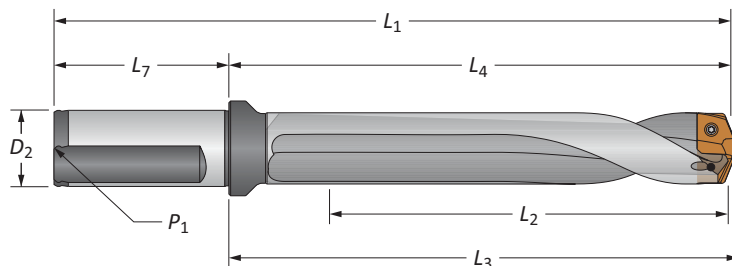

Straight and Helical

Flute	Length	Body				Shank				Part No.
		L ₂	L ₄	L ₃	L ₁	L ₇	D ₂	P ₁	Flat	
Straight	3xD	3-1/16	4-31/64	4-19/32	6-49/64	2-9/32	1	1/8	YES	60324S-100F
	5xD	5-7/64	6-17/32	6-41/64	8-13/16	2-9/32	1	1/8	YES	60524S-100F
	7xD	7-5/32	8-37/64	8-11/16	10-55/64	2-9/32	1	1/8	YES	60724S-100F
Helical	Stub	1-1/8	2-17/32	2-41/64	4-13/16	2-9/32	1	1/8	YES	60124H-100F
	3xD	3-1/16	4-31/64	4-19/32	6-49/64	2-9/32	1	1/8	YES	60324H-100F
	3xD	3-1/16	4-31/64	4-19/32	6-49/64	2-9/32	1	1/8	NO	60324H-100C
	5xD	5-7/64	6-17/32	6-41/64	8-13/16	2-9/32	1	1/8	YES	60524H-100F
	5xD	5-7/64	6-17/32	6-41/64	8-13/16	2-9/32	1	1/8	NO	60524H-100C
	7xD	7-5/32	8-37/64	8-11/16	10-55/64	2-9/32	1	1/8	YES	60724H-100F
	7xD	7-5/32	8-37/64	8-11/16	10-55/64	2-9/32	1	1/8	NO	60724H-100C
Straight	3xD	78.0	113.9	116.8	169.9	56.0	25.0	1/8*	YES	60324S-25FM
	5xD	130.0	165.9	168.7	221.9	56.0	25.0	1/8*	YES	60524S-25FM
	7xD	181.9	217.9	220.7	273.9	56.0	25.0	1/8*	YES	60724S-25FM
	Stub	28.5	64.2	67.1	120.1	56.0	25.0	1/8*	YES	60124H-25FM
	3xD	78.0	113.9	116.8	169.9	56.0	25.0	1/8*	YES	60324H-25FM
	3xD	78.0	113.9	116.8	169.9	56.0	25.0	1/8*	NO	60324H-25CM
	5xD	130.0	165.9	168.7	221.9	56.0	25.0	1/8*	YES	60524H-25FM
	5xD	130.0	165.9	168.7	221.9	56.0	25.0	1/8*	NO	60524H-25CM
	7xD	181.9	217.9	220.7	273.9	56.0	25.0	1/8*	YES	60724H-25FM
	7xD	181.9	217.9	220.7	273.9	56.0	25.0	1/8*	NO	60724H-25CM

*Thread to BSP and ISO 7-1

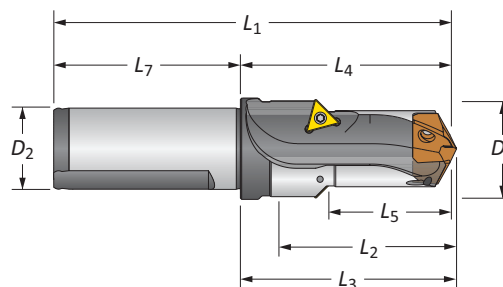

Drill / Chamfer

Step	Body				Shank		Part No.	Chamfer Insert	
	D ₅	L ₅	L ₂	L ₄	L ₃	L ₁			L ₇
1-7/32	1-27/64	1-51/64	2-17/32	2-41/64	4-13/16	2-9/32	1	60124C45-100F	TCMT-110204
31.0	36.0	45.5	64.2	67.1	120.2	56.0	25.0	60124C45-25FM	TCMT-110204

Connection Accessories

Insert Screws	Nylon Locking Screws	Insert Driver	Preset Torque Hand Driver	Replacement Tips	Admissible Tightening Torque*
739-IP9-1	739N-IP9-1	8IP-9	8IP-9TL	8IP-9B	27.0 in-lbs (305 N-cm)

*Tightening torques are calculated with a friction coefficient of $\mu = 0.14$ and develop 90% of ultimate yield strength



Chamfer inserts sold separately in multiples of 10 | Screws sold in multiples of 10

= Imperial (in)
 = Metric (mm)

GEN3SYS XT Pro Drill Inserts

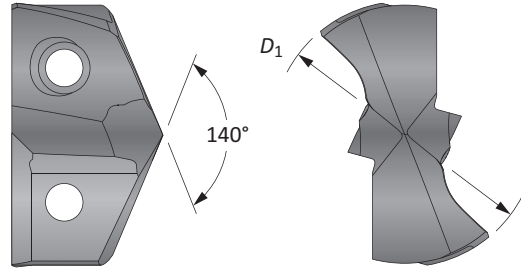
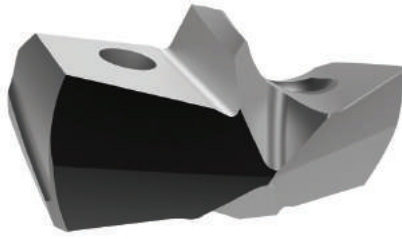
26 Series | Diameter Range: 1.0236" - 1.1416" (26.00mm - 28.99mm)



Fractional Equivalent	Insert				
	D ₁ inch	D ₁ mm	Part No. P	Part No. K	Part No. N
-	1.0236	26.00	XTP26-26.00	XTK26-26.00	XTN26-26.00
-	1.0276	26.10	XTP26-26.10	XTK26-26.10	XTN26-26.10
1-1/32	1.0313	26.20	XTP26-26.20	XTK26-26.20	XTN26-26.20
-	1.0354	26.30	XTP26-26.30	XTK26-26.30	XTN26-26.30
-	1.0394	26.40	XTP26-26.40	XTK26-26.40	XTN26-26.40
-	1.0433	26.50	XTP26-26.50	XTK26-26.50	XTN26-26.50
1-3/64	1.0460	26.57	XTP26-26.57	XTK26-26.57	XTN26-26.57
-	1.0472	26.60	XTP26-26.60	XTK26-26.60	XTN26-26.60
-	1.0512	26.70	XTP26-26.70	XTK26-26.70	XTN26-26.70
-	1.0551	26.80	XTP26-26.80	XTK26-26.80	XTN26-26.80
-	1.0591	26.90	XTP26-26.90	XTK26-26.90	XTN26-26.90
1-1/16	1.0625	26.99	XTP26-26.99	XTK26-26.99	XTN26-26.99
-	1.0630	27.00	XTP26-27.00	XTK26-27.00	XTN26-27.00
-	1.0669	27.10	XTP26-27.10	XTK26-27.10	XTN26-27.10
-	1.0709	27.20	XTP26-27.20	XTK26-27.20	XTN26-27.20
-	1.0748	27.30	XTP26-27.30	XTK26-27.30	XTN26-27.30
-	1.0787	27.40	XTP26-27.40	XTK26-27.40	XTN26-27.40
-	1.0827	27.50	XTP26-27.50	XTK26-27.50	XTN26-27.50
-	1.0866	27.60	XTP26-27.60	XTK26-27.60	XTN26-27.60
-	1.0906	27.70	XTP26-27.70	XTK26-27.70	XTN26-27.70
1-3/32	1.0938	27.78	XTP26-27.78	XTK26-27.78	XTN26-27.78
-	1.0984	27.90	XTP26-27.90	XTK26-27.90	XTN26-27.90
-	1.1024	28.00	XTP26-28.00	XTK26-28.00	XTN26-28.00
-	1.1063	28.10	XTP26-28.10	XTK26-28.10	XTN26-28.10
1-7/64	1.1090	28.17	XTP26-28.17	XTK26-28.17	XTN26-28.17
-	1.1102	28.20	XTP26-28.20	XTK26-28.20	XTN26-28.20
-	1.1142	28.30	XTP26-28.30	XTK26-28.30	XTN26-28.30
-	1.1181	28.40	XTP26-28.40	XTK26-28.40	XTN26-28.40
-	1.1220	28.50	XTP26-28.50	XTK26-28.50	XTN26-28.50
1-1/8	1.1250	28.58	XTP26-28.58	XTK26-28.58	XTN26-28.58
-	1.1299	28.70	XTP26-28.70	XTK26-28.70	XTN26-28.70
-	1.1339	28.80	XTP26-28.80	XTK26-28.80	XTN26-28.80
-	1.1378	28.90	XTP26-28.90	XTK26-28.90	XTN26-28.90

Inserts sold in multiples of 1

A20: 68 - 83

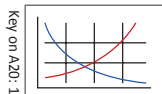

A20: 6 - 9



Sizes not shown are available upon request.	
When ordering, please follow the example below:	
Imperial:	0.5180", Steel, 13 series = use Part No. XTP13-13.16
Metric:	13.16mm, Steel, 13 series = use Part No. XTP13-13.16

GEN3SYS XT Pro Drill Insert Holders

26 Series | Diameter Range: 1.0236" - 1.1416" (26.00mm - 28.99mm)

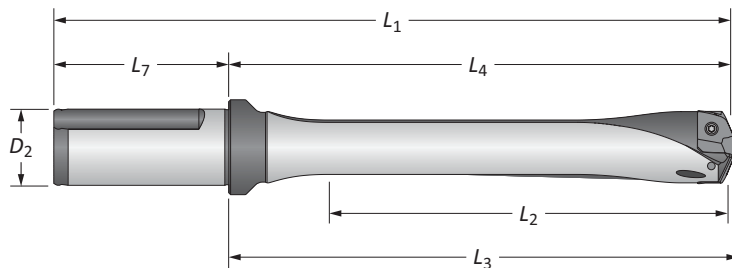

Flute	Body					Shank			Part No.
	Length	L ₂	L ₄	L ₃	L ₁	L ₇	D ₂	Flat	
i Straight 	3xD	3-27/64	5-1/16	5-11/64	7-11/32	2-9/32	1-1/4	YES	HXT0326S-125F
	3xD	3-27/64	5-1/16	5-11/64	7-11/32	2-9/32	1-1/4	NO	HXT0326S-125C
	5xD	5-45/64	7-11/32	7-29/64	9-5/8	2-9/32	1-1/4	YES	HXT0526S-125F
	5xD	5-45/64	7-11/32	7-29/64	9-5/8	2-9/32	1-1/4	NO	HXT0526S-125C
	7xD	7-63/64	9-5/8	9-47/64	11-29/32	2-9/32	1-1/4	YES	HXT0726S-125F
	7xD	7-63/64	9-5/8	9-47/64	11-29/32	2-9/32	1-1/4	NO	HXT0726S-125C
	10xD	11-13/32	13-3/64	13-11/64	15-21/64	2-9/32	1-1/4	YES	HXT1026S-125F
10xD	11-13/32	13-3/64	13-11/64	15-21/64	2-9/32	1-1/4	NO	HXT1026S-125C	
ii Straight 	3xD	87.0	128.6	131.4	188.6	60.0	32.0	YES	HXT0326S-32FM
	3xD	87.0	128.6	131.4	188.6	60.0	32.0	NO	HXT0326S-32CM
	5xD	145.0	186.5	189.4	246.5	60.0	32.0	YES	HXT0526S-32FM
	5xD	145.0	186.5	189.4	246.5	60.0	32.0	NO	HXT0526S-32CM
	7xD	202.9	244.5	247.4	304.5	60.0	32.0	YES	HXT0726S-32FM
	7xD	202.9	244.5	247.4	304.5	60.0	32.0	NO	HXT0726S-32CM
	10xD	289.9	331.4	334.4	391.4	60.0	32.0	YES	HXT1026S-32FM
	10xD	289.9	331.4	334.4	391.4	60.0	32.0	NO	HXT1026S-32CM

Connection Accessories

Insert Screws	Nylon Locking Screws	Insert Driver	Preset Torque Hand Driver	Replacement Tips	Admissible Tightening Torque*
7495-IP15-1	7495N-IP15-1	8IP-15	8IP-15TL	8IP-15B	61.0 in-lbs (690 N-cm)

*Tightening torques are calculated with a friction coefficient of $\mu = 0.14$ and develop 90% of ultimate yield strength

⚠ WARNING Refer to Speed and Feed charts for recommended adjustments to speeds and feeds. Refer to page A20: 86 for deep hole drilling guidelines in this section of the catalog. Visit www.alliedmachine.com/DeepHoleGuidelines for the most up-to-date information and procedures. Factory technical assistance is available for your specific applications through our Application Engineering Team.

i = Imperial (in)
 ii = Metric (mm)

Screws sold in multiples of 10

GEN3SYS XT Drill Inserts

26 Series | Diameter Range: 1.0236" - 1.1416" (26.00mm - 28.99mm)

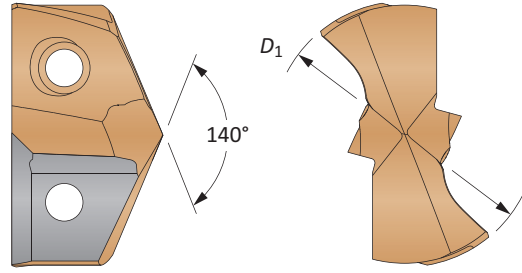
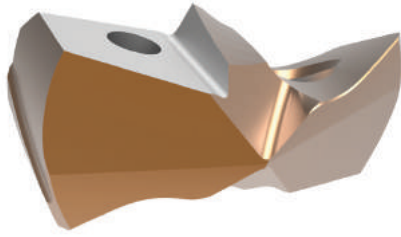

Carbide Substrate	Insert		Standard Part No.	Low Rake Part No.	Cast Iron Part No.	Stainless Part No.	
	Fractional Equivalent	D ₁ inch					D ₁ mm
C1 (K35)		1.0236	26.00	7C126P-26	7C126P-26LR	-	-
	1-1/32	1.0313	26.20	7C126P-0101	7C126P-0101LR	-	-
	1-3/64	1.0469	26.59	7C126P-1.046	7C126P-1.046LR	-	-
	1-1/16	1.0625	26.99	7C126P-0102	7C126P-0102LR	-	-
		1.0630	27.00	7C126P-27	7C126P-27LR	-	-
	1-3/32	1.0938	27.78	7C126P-0103	7C126P-0103LR	-	-
		1.1024	28.00	7C126P-28	7C126P-28LR	-	-
	1-7/64	1.1094	28.17	7C126P-1.109	7C126P-1.109LR	-	-
1-1/8	1.1250	28.58	7C126P-0104	7C126P-0104LR	-	-	
C2 (K20)		1.0236	26.00	7C226P-26	7C226P-26LR	7C226P-26CI	7C226P-26AS
	1-1/32	1.0313	26.20	7C226P-0101	7C226P-0101LR	7C226P-0101CI	7C226P-0101AS
	1-3/64	1.0469	26.59	7C226P-1.046	7C226P-1.046LR	7C226P-1.046CI	7C226P-1.046AS
	1-1/16	1.0625	26.99	7C226P-0102	7C226P-0102LR	7C226P-0102CI	7C226P-0102AS
		1.0630	27.00	7C226P-27	7C226P-27LR	7C226P-27CI	7C226P-27AS
	1-3/32	1.0938	27.78	7C226P-0103	7C226P-0103LR	7C226P-0103CI	7C226P-0103AS
		1.1024	28.00	7C226P-28	7C226P-28LR	7C226P-28CI	7C226P-28AS
	1-7/64	1.1094	28.17	7C226P-1.109	7C226P-1.109LR	7C226P-1.109CI	7C226P-1.109AS
1-1/8	1.1250	28.58	7C226P-0104	7C226P-0104LR	7C226P-0104CI	7C226P-0104AS	

Inserts sold in multiples of 1

A20: 68 - 83

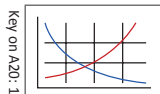

A20: 6 - 9



Sizes not shown are available upon request.
When ordering, please follow the example below:



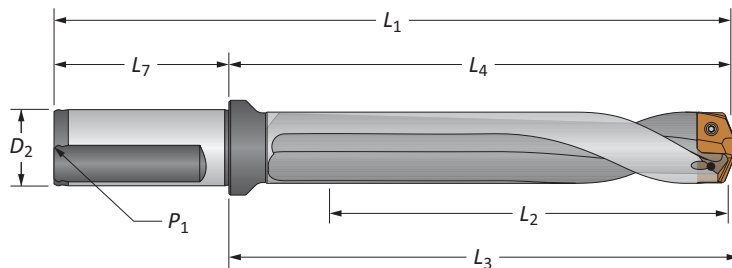

Imperial:	0.5200", 13 series, C2 = use Part No. 7C213P-.5200
Metric:	13.20mm, 13 series, C2 = use Part No. 7C213P-13.20

GEN3SYS XT Standard Drill Insert Holders

26 Series | Diameter Range: 1.0236" - 1.1416" (26.00mm - 28.99mm)





Straight and Helical

Flute	Length	Body				Shank				Flat	Part No.
		L ₂	L ₄	L ₃	L ₁	L ₇	D ₂	P ₁			
	3xD	3-27/64	5-1/16	5-11/64	7-11/32	2-9/32	1-1/4	1/8	YES	60326S-125F	
	5xD	5-45/64	7-11/32	7-29/64	9-5/8	2-9/32	1-1/4	1/8	YES	60526S-125F	
	7xD	7-63/64	9-5/8	9-47/64	11-29/32	2-9/32	1-1/4	1/8	YES	60726S-125F	
	Stub	1-1/4	2-7/8	2-63/64	5-5/32	2-9/32	1-1/4	1/8	YES	60126H-125F	
	3xD	3-27/64	5-1/16	5-11/64	7-11/32	2-9/32	1-1/4	1/8	YES	60326H-125F	
	3xD	3-27/64	5-1/16	5-11/64	7-11/32	2-9/32	1-1/4	1/8	NO	60326H-125C	
	5xD	5-45/64	7-11/32	7-29/64	9-5/8	2-9/32	1-1/4	1/8	YES	60526H-125F	
	5xD	5-45/64	7-11/32	7-29/64	9-5/8	2-9/32	1-1/4	1/8	NO	60526H-125C	
	7xD	7-63/64	9-5/8	9-47/64	11-29/32	2-9/32	1-1/4	1/8	YES	60726H-125F	
	7xD	7-63/64	9-5/8	9-47/64	11-29/32	2-9/32	1-1/4	1/8	NO	60726H-125C	
	3xD	87.0	128.6	131.4	188.6	60.0	32.0	1/8*	YES	60326S-32FM	
	5xD	145.0	186.5	189.4	246.5	60.0	32.0	1/8*	YES	60526S-32FM	
	7xD	202.9	244.5	247.4	304.5	60.0	32.0	1/8*	YES	60726S-32FM	
	Stub	32.0	72.9	75.7	132.9	60.0	32.0	1/8*	YES	60126H-32FM	
		3xD	87.0	128.6	131.4	188.6	60.0	32.0	1/8*	YES	60326H-32FM
		3xD	87.0	128.6	131.4	188.6	60.0	32.0	1/8*	NO	60326H-32CM
		5xD	145.0	186.5	189.4	246.5	60.0	32.0	1/8*	YES	60526H-32FM
		5xD	145.0	186.5	189.4	246.5	60.0	32.0	1/8*	NO	60526H-32CM
		7xD	202.9	244.5	247.4	304.5	60.0	32.0	1/8*	YES	60726H-32FM
		7xD	202.9	244.5	247.4	304.5	60.0	32.0	1/8*	NO	60726H-32CM

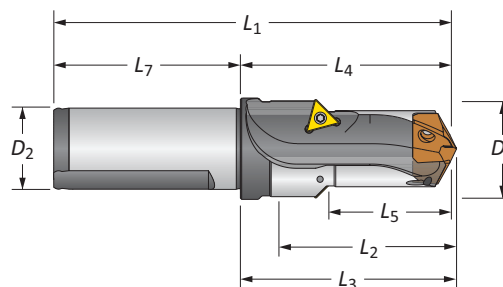



*Thread to BSP and ISO 7-1



Drill / Chamfer

Step	Body				Shank			Part No.		Chamfer Insert
	D ₅	L ₅	L ₂	L ₄	L ₃	L ₁	L ₇			
	1-11/32	1-17/32	2-3/64	2-7/8	2-63/64	5-5/32	2-9/32	1-1/4	60126C45-125F	TCMT-110204
	34.0	39.0	52.1	72.9	75.7	132.9	60.0	32.0	60126C45-32FM	TCMT-110204

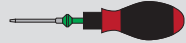
Connection Accessories

					Admissible Tightening Torque*
7495-IP15-1	7495N-IP15-1	8IP-15	8IP-15TL	8IP-15B	61.0 in-lbs (690 N-cm)

*Tightening torques are calculated with a friction coefficient of $\mu = 0.14$ and develop 90% of ultimate yield strength



Chamfer inserts sold separately in multiples of 10 | Screws sold in multiples of 10

 = Imperial (in)
 = Metric (mm)

GEN3SYS XT Pro Drill Inserts

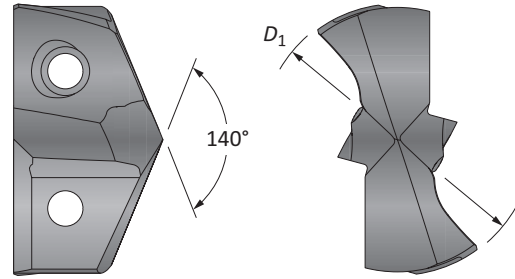
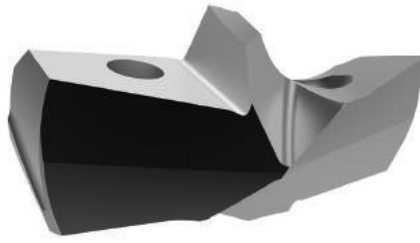
29 Series | Diameter Range: 1.1417" - 1.2597" (29.00mm - 31.99mm)



Fractional Equivalent	Insert				
	D ₁ inch	D ₁ mm	P	K	N
-	1.1417	29.00	XTP29-29.00	XTK29-29.00	XTN29-29.00
-	1.1457	29.10	XTP29-29.10	XTK29-29.10	XTN29-29.10
-	1.1496	29.20	XTP29-29.20	XTK29-29.20	XTN29-29.20
-	1.1535	29.30	XTP29-29.30	XTK29-29.30	XTN29-29.30
1-5/32	1.1563	29.37	XTP29-29.37	XTK29-29.37	XTN29-29.37
-	1.1575	29.40	XTP29-29.40	XTK29-29.40	XTN29-29.40
-	1.1614	29.50	XTP29-29.50	XTK29-29.50	XTN29-29.50
-	1.1654	29.60	XTP29-29.60	XTK29-29.60	XTN29-29.60
-	1.1693	29.70	XTP29-29.70	XTK29-29.70	XTN29-29.70
-	1.1732	29.80	XTP29-29.80	XTK29-29.80	XTN29-29.80
-	1.1772	29.90	XTP29-29.90	XTK29-29.90	XTN29-29.90
-	1.1811	30.00	XTP29-30.00	XTK29-30.00	XTN29-30.00
-	1.1850	30.10	XTP29-30.10	XTK29-30.10	XTN29-30.10
1-3/16	1.1875	30.16	XTP29-30.16	XTK29-30.16	XTN29-30.16
-	1.1890	30.20	XTP29-30.20	XTK29-30.20	XTN29-30.20
-	1.1929	30.30	XTP29-30.30	XTK29-30.30	XTN29-30.30
-	1.1969	30.40	XTP29-30.40	XTK29-30.40	XTN29-30.40
-	1.2008	30.50	XTP29-30.50	XTK29-30.50	XTN29-30.50
-	1.2047	30.60	XTP29-30.60	XTK29-30.60	XTN29-30.60
-	1.2087	30.70	XTP29-30.70	XTK29-30.70	XTN29-30.70
-	1.2126	30.80	XTP29-30.80	XTK29-30.80	XTN29-30.80
-	1.2165	30.90	XTP29-30.90	XTK29-30.90	XTN29-30.90
1-7/32	1.2188	30.96	XTP29-30.96	XTK29-30.96	XTN29-30.96
-	1.2205	31.00	XTP29-31.00	XTK29-31.00	XTN29-31.00
-	1.2244	31.10	XTP29-31.10	XTK29-31.10	XTN29-31.10
-	1.2283	31.20	XTP29-31.20	XTK29-31.20	XTN29-31.20
-	1.2323	31.30	XTP29-31.30	XTK29-31.30	XTN29-31.30
-	1.2362	31.40	XTP29-31.40	XTK29-31.40	XTN29-31.40
-	1.2402	31.50	XTP29-31.50	XTK29-31.50	XTN29-31.50
-	1.2441	31.60	XTP29-31.60	XTK29-31.60	XTN29-31.60
-	1.2480	31.70	XTP29-31.70	XTK29-31.70	XTN29-31.70
1-1/4	1.2500	31.75	XTP29-31.75	XTK29-31.75	XTN29-31.75
-	1.2520	31.80	XTP29-31.80	XTK29-31.80	XTN29-31.80
-	1.2559	31.90	XTP29-31.90	XTK29-31.90	XTN29-31.90

Inserts sold in multiples of 1

A20: 68 - 83

A20: 6 - 9

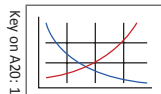



Sizes not shown are available upon request.	
When ordering, please follow the example below:	
Imperial:	0.5180", Steel, 13 series = use Part No. XTP13-13.16
Metric:	13.16mm, Steel, 13 series = use Part No. XTP13-13.16



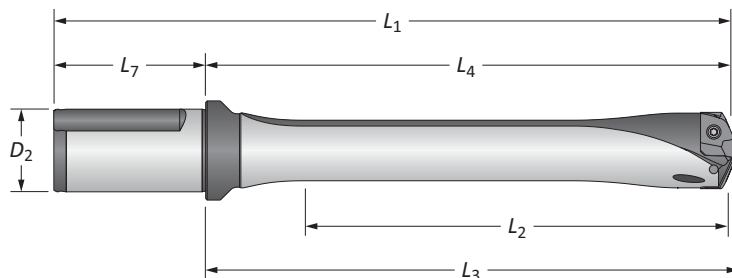

GEN3SYS XT Pro Drill Insert Holders

29 Series | Diameter Range: 1.1417" - 1.2597" (29.00mm - 31.99mm)

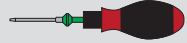

Flute	Body					Shank			Part No.
	Length	L ₂	L ₄	L ₃	L ₁	L ₇	D ₂	Flat	
i Straight 	3xD	3-25/32	5-3/8	5-1/2	7-21/32	2-9/32	1-1/4	YES	HXT0329S-125F
	3xD	3-25/32	5-3/8	5-1/2	7-21/32	2-9/32	1-1/4	NO	HXT0329S-125C
	5xD	6-19/64	7-29/32	8-1/64	10-3/16	2-9/32	1-1/4	YES	HXT0529S-125F
	5xD	6-19/64	7-29/32	8-1/64	10-3/16	2-9/32	1-1/4	NO	HXT0529S-125C
	7xD	8-13/16	10-27/64	10-17/64	12-45/64	2-9/32	1-1/4	YES	HXT0729S-125F
	7xD	8-13/16	10-27/64	10-17/64	12-45/64	2-9/32	1-1/4	NO	HXT0729S-125C
	10xD	12-19/32	14-3/16	14-5/16	16-15/32	2-9/32	1-1/4	YES	HXT1029S-125F
10xD	12-19/32	14-3/16	14-5/16	16-15/32	2-9/32	1-1/4	NO	HXT1029S-125C	
ii Straight 	3xD	96.0	136.5	139.7	196.5	60.0	32.0	YES	HXT0329S-32FM
	3xD	96.0	136.5	139.7	196.5	60.0	32.0	NO	HXT0329S-32CM
	5xD	160.0	200.8	203.7	260.8	60.0	32.0	YES	HXT0529S-32FM
	5xD	160.0	200.8	203.7	260.8	60.0	32.0	NO	HXT0529S-32CM
	7xD	223.9	264.7	267.6	324.7	60.0	32.0	YES	HXT0729S-32FM
	7xD	223.9	264.7	267.6	324.7	60.0	32.0	NO	HXT0729S-32CM
	10xD	319.9	360.4	363.6	420.4	60.0	32.0	YES	HXT1029S-32FM
	10xD	319.9	360.4	363.6	420.4	60.0	32.0	NO	HXT1029S-32CM

Connection Accessories

					Admissible Tightening Torque*
7495-IP15-1	7495N-IP15-1	8IP-15	8IP-15TL	8IP-15B	61.0 in-lbs (690 N-cm)

*Tightening torques are calculated with a friction coefficient of $\mu = 0.14$ and develop 90% of ultimate yield strength

WARNING Refer to Speed and Feed charts for recommended adjustments to speeds and feeds. Refer to page A20: 86 for deep hole drilling guidelines in this section of the catalog. Visit www.alliedmachine.com/DeepHoleGuidelines for the most up-to-date information and procedures. Factory technical assistance is available for your specific applications through our Application Engineering Team.

i = Imperial (in)
 ii = Metric (mm)

Screws sold in multiples of 10









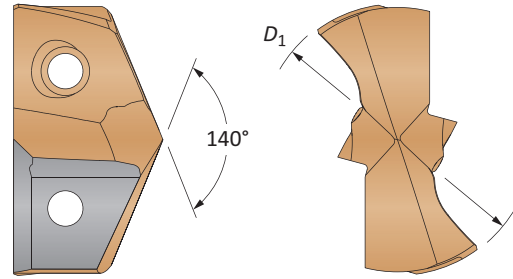
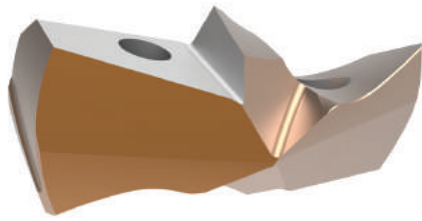























































A DRILLING
 B BORING
 C REAMING
 D BURNISHING
 E THREADING
 X SPECIALS



GEN3SYS XT Drill Inserts

29 Series | Diameter Range: 1.1417" - 1.2597" (29.00mm - 31.99mm)



Carbide Substrate	Insert			Standard Part No.	Low Rake Part No.	Cast Iron Part No.	Stainless Part No.
	Fractional Equivalent	D_1 inch	D_1 mm				
C1 (K35)	-	1.1417	29.00				
	1-5/32	1.1563	29.37				
	-	1.1811	30.00				
	1-3/16	1.1875	30.16				
	-	1.2008	30.50				
	1-7/32	1.2188	30.96				
	-	1.2205	31.00				
	1-1/4	1.2500	31.75				
C2 (K20)	-	1.1417	29.00				
	1-5/32	1.1563	29.37				
	-	1.1811	30.00				
	1-3/16	1.1875	30.16				
	-	1.2008	30.50				
	1-7/32	1.2188	30.96				
	-	1.2205	31.00				
	1-1/4	1.2500	31.75				

Inserts sold in multiples of 1

A20: 68 - 83

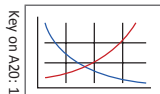

A20: 6 - 9



Sizes not shown are available upon request.
When ordering, please follow the example below:

Imperial:	0.5200", 13 series, C2 = use Part No. 7C213P-5200
Metric:	13.20mm, 13 series, C2 = use Part No. 7C213P-13.20

GEN3SYS XT Standard Drill Insert Holders

29 Series | Diameter Range: 1.1417" - 1.2597" (29.00mm - 31.99mm)

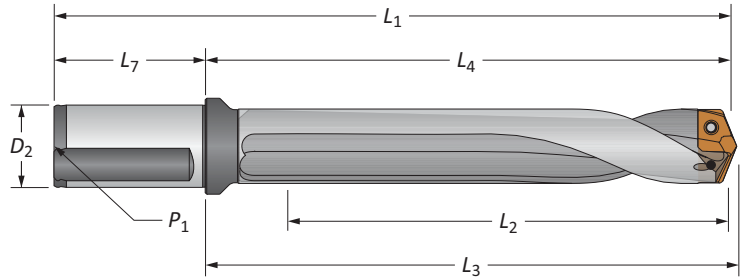

Straight and Helical

Flute	Length	Body				Shank				Flat	Part No.
		L ₂	L ₄	L ₃	L ₁	L ₇	D ₂	P ₁			
Straight	3xD	3-25/32	5-3/8	5-1/2	7-21/32	2-9/32	1-1/4	1/4	YES	60329S-125F	
	5xD	6-19/64	7-29/32	8-1/64	10-3/16	2-9/32	1-1/4	1/4	YES	60529S-125F	
	7xD	8-13/16	10-27/64	10-17/64	12-45/64	2-9/32	1-1/4	1/4	YES	60729S-125F	
Helical	Stub	1-3/8	2-31/32	3-5/64	5-1/4	2-9/32	1-1/4	1/4	YES	60129H-125F	
	3xD	3-25/32	5-3/8	5-1/2	7-21/32	2-9/32	1-1/4	1/4	YES	60329H-125F	
	3xD	3-25/32	5-3/8	5-1/2	7-21/32	2-9/32	1-1/4	1/4	NO	60329H-125C	
	5xD	6-19/64	7-29/32	8-1/64	10-3/16	2-9/32	1-1/4	1/4	YES	60529H-125F	
	5xD	6-19/64	7-29/32	8-1/64	10-3/16	2-9/32	1-1/4	1/4	NO	60529H-125C	
	7xD	8-13/16	10-27/64	10-17/64	12-45/64	2-9/32	1-1/4	1/4	YES	60729H-125F	
	7xD	8-13/16	10-27/64	10-17/64	12-45/64	2-9/32	1-1/4	1/4	NO	60729H-125C	
Straight	3xD	96.0	136.5	139.7	196.5	60.0	32.0	1/4*	YES	60329S-32FM	
	5xD	160.0	200.8	203.7	260.8	60.0	32.0	1/4*	YES	60529S-32FM	
	7xD	223.9	264.7	267.6	324.7	60.0	32.0	1/4*	YES	60729S-32FM	
	Stub	35.0	75.2	78.2	135.2	60.0	32.0	1/4*	YES	60129H-32FM	
	Helical	3xD	96.0	136.5	139.7	196.5	60.0	32.0	1/4*	YES	60329H-32FM
		3xD	96.0	136.5	139.7	196.5	60.0	32.0	1/4*	NO	60329H-32CM
		5xD	160.0	200.8	203.7	260.8	60.0	32.0	1/4*	YES	60529H-32FM
		5xD	160.0	200.8	203.7	260.8	60.0	32.0	1/4*	NO	60529H-32CM
		7xD	223.9	264.7	267.6	324.7	60.0	32.0	1/4*	YES	60729H-32FM
		7xD	223.9	264.7	267.6	324.7	60.0	32.0	1/4*	NO	60729H-32CM

*Thread to BSP and ISO 7-1

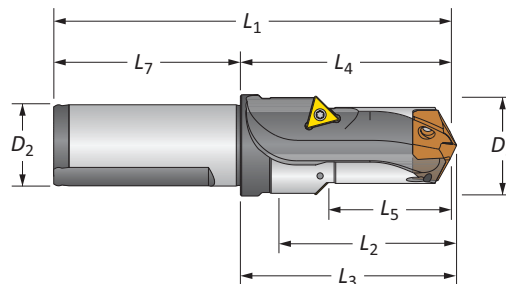

Drill / Chamfer

Step	Body				Shank			Part No.	Chamfer Insert
	D ₅	L ₅	L ₂	L ₄	L ₃	L ₁	L ₇		
1-29/64	1-23/32	2-13/64	2-31/32	3-5/64	5-1/4	2-9/32	1-1/4	60129C45-125F	TCMT-16T304
37.1	43.5	55.9	75.2	78.2	135.2	60.0	32.0	60129C45-32FM	TCMT-16T304

Connection Accessories

Insert Screws	Nylon Locking Screws	Insert Driver	Preset Torque Hand Driver	Replacement Tips	Admissible Tightening Torque*
7495-IP15-1	7495N-IP15-1	8IP-15	8IP-15TL	8IP-15B	61.0 in-lbs (690 N-cm)

*Tightening torques are calculated with a friction coefficient of $\mu = 0.14$ and develop 90% of ultimate yield strength



Chamfer inserts sold separately in multiples of 10 | Screws sold in multiples of 10

= Imperial (in)
 = Metric (mm)

GEN3SYS XT Pro Drill Inserts

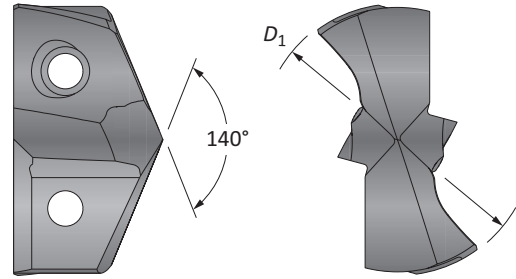
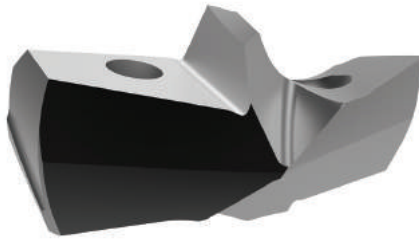
32 Series | Diameter Range: 1.2598" - 1.3780" (32.00mm - 35.00mm)



Fractional Equivalent	Insert				
	D ₁ inch	D ₁ mm	P	K	N
-	1.2598	32.00	XTP32-32.00	XTK32-32.00	XTN32-32.00
-	1.2638	32.10	XTP32-32.10	XTK32-32.10	XTN32-32.10
1-17/64	1.2657	32.15	XTP32-32.15	XTK32-32.15	XTN32-32.15
-	1.2677	32.20	XTP32-32.20	XTK32-32.20	XTN32-32.20
-	1.2717	32.30	XTP32-32.30	XTK32-32.30	XTN32-32.30
-	1.2756	32.40	XTP32-32.40	XTK32-32.40	XTN32-32.40
-	1.2795	32.50	XTP32-32.50	XTK32-32.50	XTN32-32.50
1-9/32	1.2813	32.55	XTP32-32.55	XTK32-32.55	XTN32-32.55
-	1.2835	32.60	XTP32-32.60	XTK32-32.60	XTN32-32.60
-	1.2874	32.70	XTP32-32.70	XTK32-32.70	XTN32-32.70
-	1.2913	32.80	XTP32-32.80	XTK32-32.80	XTN32-32.80
-	1.2953	32.90	XTP32-32.90	XTK32-32.90	XTN32-32.90
-	1.2992	33.00	XTP32-33.00	XTK32-33.00	XTN32-33.00
-	1.3031	33.10	XTP32-33.10	XTK32-33.10	XTN32-33.10
-	1.3071	33.20	XTP32-33.20	XTK32-33.20	XTN32-33.20
-	1.3110	33.30	XTP32-33.30	XTK32-33.30	XTN32-33.30
1-5/16	1.3125	33.34	XTP32-33.34	XTK32-33.34	XTN32-33.34
-	1.3150	33.40	XTP32-33.40	XTK32-33.40	XTN32-33.40
-	1.3189	33.50	XTP32-33.50	XTK32-33.50	XTN32-33.50
-	1.3228	33.60	XTP32-33.60	XTK32-33.60	XTN32-33.60
-	1.3268	33.70	XTP32-33.70	XTK32-33.70	XTN32-33.70
-	1.3307	33.80	XTP32-33.80	XTK32-33.80	XTN32-33.80
-	1.3346	33.90	XTP32-33.90	XTK32-33.90	XTN32-33.90
-	1.3386	34.00	XTP32-34.00	XTK32-34.00	XTN32-34.00
-	1.3425	34.10	XTP32-34.10	XTK32-34.10	XTN32-34.10
1-11/32	1.3438	34.13	XTP32-34.13	XTK32-34.13	XTN32-34.13
-	1.3465	34.20	XTP32-34.20	XTK32-34.20	XTN32-34.20
-	1.3504	34.30	XTP32-34.30	XTK32-34.30	XTN32-34.30
-	1.3543	34.40	XTP32-34.40	XTK32-34.40	XTN32-34.40
-	1.3583	34.50	XTP32-34.50	XTK32-34.50	XTN32-34.50
-	1.3622	34.60	XTP32-34.60	XTK32-34.60	XTN32-34.60
-	1.3661	34.70	XTP32-34.70	XTK32-34.70	XTN32-34.70
-	1.3701	34.80	XTP32-34.80	XTK32-34.80	XTN32-34.80
-	1.3740	34.90	XTP32-34.90	XTK32-34.90	XTN32-34.90
1-3/8	1.3750	34.93	XTP32-34.93	XTK32-34.93	XTN32-34.93
-	1.3780	35.00	XTP32-35.00	XTK32-35.00	XTN32-35.00

Inserts sold in multiples of 1

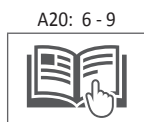
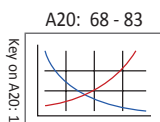



Sizes not shown are available upon request.	
When ordering, please follow the example below:	
Imperial:	0.5180", Steel, 13 series = use Part No. XTP13-13.16
Metric:	13.16mm, Steel, 13 series = use Part No. XTP13-13.16

GEN3SYS XT Pro Drill Insert Holders

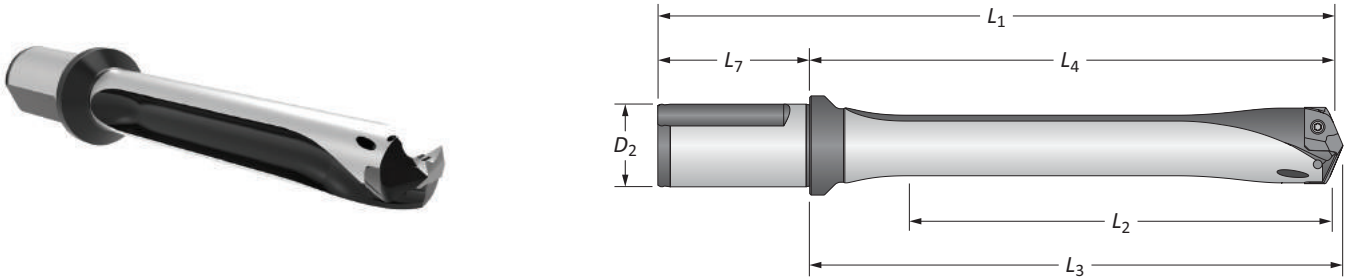
32 Series | Diameter Range: 1.2598" - 1.3780" (32.00mm - 35.00mm)



Flute	Body					Shank			Part No.
	Length	L ₂	L ₄	L ₃	L ₁	L ₇	D ₂	Flat	
i  Straight	3xD	4-9/64	6-7/32	6-23/64	8-29/32	2-11/16	1-1/2	YES	HXT0332S-150F
	3xD	4-9/64	6-7/32	6-23/64	8-29/32	2-11/16	1-1/2	NO	HXT0332S-150C
	5xD	6-57/64	8-31/32	9-7/64	11-21/32	2-11/16	1-1/2	YES	HXT0532S-150F
	5xD	6-57/64	8-31/32	9-7/64	11-21/32	2-11/16	1-1/2	NO	HXT0532S-150C
	7xD	9-41/64	11-23/32	11-55/64	14-13/32	2-11/16	1-1/2	YES	HXT0732S-150F
	7xD	9-41/64	11-23/32	11-55/64	14-13/32	2-11/16	1-1/2	NO	HXT0732S-150C
	10xD	13-25/32	15-55/64	16	18-35/64	2-11/16	1-1/2	YES	HXT1032S-150F
10xD	13-25/32	15-55/64	16	18-35/64	2-11/16	1-1/2	NO	HXT1032S-150C	
ii  Straight	3xD	105.0	150.7	154.3	210.7	60.0	32.0	YES	HXT0332S-32FM
	3xD	105.0	150.7	154.3	210.7	60.0	32.0	NO	HXT0332S-32CM
	5xD	175.0	220.7	224.3	280.7	60.0	32.0	YES	HXT0532S-32FM
	5xD	175.0	220.7	224.3	280.7	60.0	32.0	NO	HXT0532S-32CM
	7xD	245.0	290.7	294.3	350.7	60.0	32.0	YES	HXT0732S-32FM
	7xD	245.0	290.7	294.3	350.7	60.0	32.0	NO	HXT0732S-32CM
	10xD	350.0	395.7	399.3	455.7	60.0	32.0	YES	HXT1032S-32FM
	10xD	350.0	395.7	399.3	455.7	60.0	32.0	NO	HXT1032S-32CM

Connection Accessories

Insert Screws	Nylon Locking Screws	Insert Driver	Preset Torque Hand Driver	Replacement Tips	Admissible Tightening Torque*
7495-IP15-1	7495N-IP15-1	8IP-15	8IP-15TL	8IP-15B	61.0 in-lbs (690 N-cm)

*Tightening torques are calculated with a friction coefficient of $\mu = 0.14$ and develop 90% of ultimate yield strength

⚠ WARNING Refer to Speed and Feed charts for recommended adjustments to speeds and feeds. Refer to page A20: 86 for deep hole drilling guidelines in this section of the catalog. Visit www.alliedmachine.com/DeepHoleGuidelines for the most up-to-date information and procedures. Factory technical assistance is available for your specific applications through our Application Engineering Team.

i = Imperial (in)
 ii = Metric (mm)

Screws sold in multiples of 10

GEN3SYS XT Drill Inserts

32 Series | Diameter Range: 1.2598" - 1.3780" (32.00mm - 35.00mm)

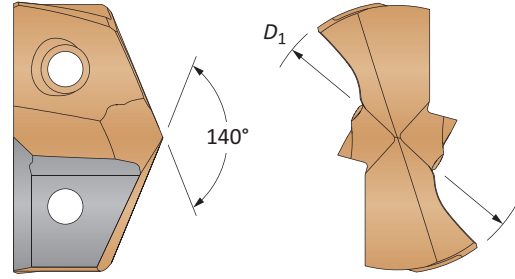
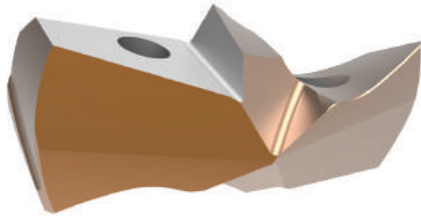

Carbide Substrate	Insert			Standard Part No.	Low Rake Part No.	Cast Iron Part No.	Stainless Part No.
	Fractional Equivalent	D ₁ inch	D ₁ mm				
C1 (K35)	-	1.2598	32.00	7C132P-32	7C132P-32LR	-	-
	1-17/64	1.2658	32.15	7C132P-32.15	7C132P-32.15LR	-	-
	-	1.2795	32.50	7C132P-32.5	7C132P-32.5LR	-	-
	1-9/32	1.2813	32.55	7C132P-0109	7C132P-0109LR	-	-
	-	1.2992	33.00	7C132P-33	7C132P-33LR	-	-
	1-5/16	1.3125	33.34	7C132P-0110	7C132P-0110LR	-	-
	-	1.3189	33.50	7C132P-33.5	7C132P-33.5LR	-	-
	-	1.3386	34.00	7C132P-34	7C132P-34LR	-	-
	1-11/32	1.3438	34.13	7C132P-0111	7C132P-0111LR	-	-
	-	1.3583	34.50	7C132P-34.5	7C132P-34.5LR	-	-
-	1.3750	34.93	7C132P-0112	7C132P-0112LR	-	-	
-	1.3780	35.00	7C132P-35	7C132P-35LR	-	-	
C2 (K20)	-	1.2598	32.00	7C232P-32	7C232P-32LR	7C232P-32CI	7C232P-32AS
	1-17/64	1.2658	32.15	7C232P-32.15	7C232P-32.15LR	7C232P-32.15CI	7C232P-32.15AS
	-	1.2795	32.50	7C232P-32.5	7C232P-32.5LR	7C232P-32.5CI	7C232P-32.5AS
	1-9/32	1.2813	32.55	7C232P-0109	7C232P-0109LR	7C232P-0109CI	7C232P-0109AS
	-	1.2992	33.00	7C232P-33	7C232P-33LR	7C232P-33CI	7C232P-33AS
	1-5/16	1.3125	33.34	7C232P-0110	7C232P-0110LR	7C232P-0110CI	7C232P-0110AS
	-	1.3189	33.50	7C232P-33.5	7C232P-33.5LR	7C232P-33.5CI	7C232P-33.5AS
	-	1.3386	34.00	7C232P-34	7C232P-34LR	7C232P-34CI	7C232P-34AS
	1-11/32	1.3438	34.13	7C232P-0111	7C232P-0111LR	7C232P-0111CI	7C232P-0111AS
	-	1.3583	34.50	7C232P-34.5	7C232P-34.5LR	7C232P-34.5CI	7C232P-34.5AS
-	1.3750	34.93	7C232P-0112	7C232P-0112LR	7C232P-0112CI	7C232P-0112AS	
-	1.3780	35.00	7C232P-35	7C232P-35LR	7C232P-35CI	7C232P-35AS	

Inserts sold in multiples of 1

A20: 68 - 83

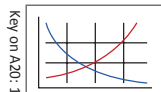

A20: 6 - 9



Sizes not shown are available upon request.
When ordering, please follow the example below:

Imperial:	0.5200", 13 series, C2 = use Part No. 7C213P-.5200
Metric:	13.20mm, 13 series, C2 = use Part No. 7C213P-13.20

GEN3SYS XT Standard Drill Insert Holders

32 Series | Diameter Range: 1.2598" - 1.3780" (32.00mm - 35.00mm)

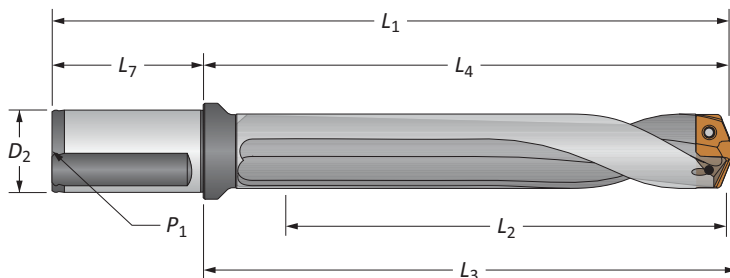

Straight and Helical

Flute	Length	Body				Shank				Flat	Part No.
		L ₂	L ₄	L ₃	L ₁	L ₇	D ₂	P ₁			
Straight	3xD	4-9/64	6-7/32	6-23/64	8-29/32	2-11/16	1-1/2	1/4	YES	60332S-150F	
	5xD	6-57/64	8-31/32	9-7/64	11-21/32	2-11/16	1-1/2	1/4	YES	60532S-150F	
	7xD	9-41/64	11-23/32	11-55/64	14-13/32	2-11/16	1-1/2	1/4	YES	60732S-150F	
Helical	Stub	1-1/2	3-37/64	3-45/64	6-1/4	2-11/16	1-1/2	1/4	YES	60132H-150F	
	3xD	4-9/64	6-7/32	6-23/64	8-29/32	2-11/16	1-1/2	1/4	YES	60332H-150F	
	3xD	4-9/64	6-7/32	6-23/64	8-29/32	2-11/16	1-1/2	1/4	NO	60332H-150C	
	5xD	6-57/64	8-31/32	9-7/64	11-21/32	2-11/16	1-1/2	1/4	YES	60532H-150F	
	5xD	6-57/64	8-31/32	9-7/64	11-21/32	2-11/16	1-1/2	1/4	NO	60532H-150C	
	7xD	9-41/64	11-23/32	11-55/64	14-13/32	2-11/16	1-1/2	1/4	YES	60732H-150F	
	7xD	9-41/64	11-23/32	11-55/64	14-13/32	2-11/16	1-1/2	1/4	NO	60732H-150C	
Straight	3xD	105.0	150.7	154.3	220.7	70.0	40.0	1/4*	YES	60332S-40FM	
	5xD	175.0	220.7	224.3	290.7	70.0	40.0	1/4*	YES	60532S-40FM	
	7xD	245.0	290.7	294.3	360.7	70.0	40.0	1/4*	YES	60732S-40FM	
	Stub	38.0	90.7	94.2	160.7	70.0	40.0	1/4*	YES	60132H-40FM	
	Helical	3xD	105.0	150.7	154.3	220.7	70.0	40.0	1/4*	YES	60332H-40FM
		3xD	105.0	150.7	154.3	220.7	70.0	40.0	1/4*	NO	60332H-40CM
		5xD	175.0	220.7	224.3	290.7	70.0	40.0	1/4*	YES	60532H-40FM
		5xD	175.0	220.7	224.3	290.7	70.0	40.0	1/4*	NO	60532H-40CM
		7xD	245.0	290.7	294.3	360.7	70.0	40.0	1/4*	YES	60732H-40FM
		7xD	245.0	290.7	294.3	360.7	70.0	40.0	1/4*	NO	60732H-40CM

*Thread to BSP and ISO 7-1

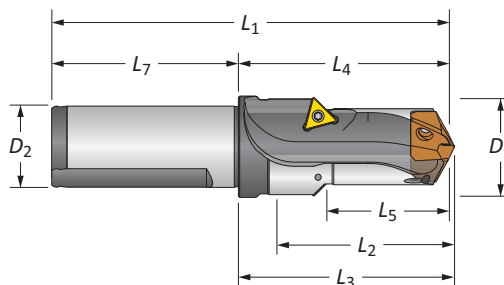

Drill / Chamfer

Step	Body				Shank			Part No.	Chamfer Insert
	D ₅	L ₅	L ₂	L ₄	L ₃	L ₁	L ₇		
1-37/64	1-57/64	2-29/64	3-37/64	3-23/32	6-1/4	2-11/16	1-1/2	60132C45-150F	TCMT-16T304
40.1	48.0	62.4	90.7	94.2	160.7	70.0	40.0	60132C45-40FM	TCMT-16T304

Connection Accessories

Insert Screws	Nylon Locking Screws	Insert Driver	Preset Torque Hand Driver	Replacement Tips	Admissible Tightening Torque*
7495-IP15-1	7495N-IP15-1	8IP-15	8IP-15TL	8IP-15B	61.0 in-lbs (690 N-cm)

*Tightening torques are calculated with a friction coefficient of $\mu = 0.14$ and develop 90% of ultimate yield strength

Chamfer inserts sold separately in multiples of 10 | Screws sold in multiples of 10

= Imperial (in)
 = Metric (mm)

A DRILLING
B BORING
C REAMING
D BURNISHING
E THREADING
X SPECIALS

Recommended Drilling Data | Imperial (inch)

GEN3SYS XT Pro

ISO	Material	Hardness (BHN)	Speed (SFM)	Feed Rate (IPR) by Diameter			
				11 series 0.4331 - 0.4723	12 series 0.4724 - 0.5117	13 series 0.5118 - 0.5511	14 series 0.5512 - 0.5905
P	Free Machining Steel 1118, 1215, 12L14, etc.	100 - 150	550	0.011	0.012	0.013	0.014
		150 - 200	475	0.010	0.011	0.012	0.013
		200 - 250	425	0.008	0.009	0.010	0.011
	Low Carbon Steel 1010, 1020, 1025, 1522, 1144, etc.	85 - 125	520	0.011	0.012	0.013	0.014
		125 - 175	450	0.010	0.011	0.012	0.013
		175 - 225	410	0.009	0.010	0.011	0.012
	Medium Carbon Steel 1030, 1040, 1050, 1527, 1140, 1151, etc.	225 - 275	350	0.007	0.008	0.009	0.010
		125 - 175	450	0.010	0.011	0.012	0.013
		175 - 225	410	0.009	0.010	0.011	0.012
	Alloy Steel 4140, 5140, 8640, etc.	225 - 275	350	0.008	0.009	0.010	0.011
		275 - 325	300	0.007	0.008	0.009	0.010
		125 - 175	415	0.010	0.011	0.012	0.013
		175 - 225	380	0.009	0.010	0.011	0.012
	High Strength Alloy 4340, 4330V, 300M, etc.	225 - 275	340	0.008	0.009	0.010	0.011
		275 - 325	310	0.006	0.007	0.008	0.009
		325 - 375	280	0.006	0.006	0.007	0.008
		225 - 300	250	0.008	0.009	0.010	0.011
	Structural Steel A36, A285, A516, etc.	300 - 350	225	0.006	0.007	0.008	0.009
		350 - 400	200	0.005	0.006	0.007	0.008
		100 - 150	410	0.010	0.011	0.012	0.013
Tool Steel H-13, H-21, A-4, O-2, S-3, etc.	150 - 250	330	0.008	0.009	0.010	0.011	
	250 - 350	305	0.007	0.008	0.009	0.010	
S	High Temp Alloy Hastelloy B, Inconel 600, etc.	150 - 200	265	0.006	0.007	0.007	0.008
		200 - 250	205	0.005	0.006	0.006	0.007
	Titanium Alloy	140 - 220	130	0.006	0.007	0.007	0.008
		220 - 310	100	0.005	0.006	0.006	0.007
	Aerospace Alloy S82	140 - 220	140	0.005	0.006	0.007	0.008
		220 - 310	110	0.004	0.005	0.006	0.007
M	Stainless Steel 400 Series 416, 420, etc.	185 - 275	165	0.004	0.004	0.005	0.005
		275 - 350	180	0.005	0.006	0.006	0.007
	Stainless Steel 300 Series 304, 316, 17-4PH, etc.	185 - 275	165	0.004	0.004	0.005	0.005
		135 - 185	220	0.004	0.005	0.005	0.006
	Super Duplex Stainless Steel	135 - 185	125	0.003	0.003	0.003	0.004
		185 - 275	100	0.002	0.002	0.003	0.003

7xD Adjustment Example (0.80 Adjustment)

Data • Adjustment Value	Speed/Feed (7xD)
200 SFM • 0.80	= 160 SFM
0.008 IPR • 0.80	= 0.0064 IPR

10xD Adjustment Example (0.70 Adjustment)

Speed • Adjustment Value	Speed/Feed (10xD)
200 SFM • 0.70	= 140 SFM
0.008 IPR • 0.70	= 0.0056 IPR

⚠ WARNING Tool failure can cause serious injury. To prevent:

- When using holders without support bushing, use a short GEN3SYS holder to establish an initial hole that is a minimum of 2 diameters deep.
- Do not rotate tool holders more than 50 RPM unless it is engaged with the workpiece or fixture.

Visit www.alliedmachine.com/DeepHoleGuidelines for the most up-to-date information and procedures. Factory technical assistance is available for your specific applications through our Application Engineering Team.

IMPORTANT: The speeds and feeds listed above are a general starting point for all applications. Refer to the coolant recommendation charts for coolant requirements to run at the recommended speeds and feeds. Factory technical assistance is available through our Application Engineering department. For 7xD and 10xD holder lengths, see adjustment example above.

A
DRILLING
B
BORING
C
REAMING
D
BURNISHING
E
THREADING
X
SPECIALS

Feed Rate (IPR) by Diameter									
15 series 0.5906 - 0.6298	16 series 0.6299 - 0.6692	17 series 0.6693 - 0.7086	18 series 0.7087 - 0.7873	20 series 0.7874 - 0.8660	22 series 0.8661 - 0.9448	24 series 0.9449 - 1.0235	26 series 1.0236 - 1.1416	29 series 1.1417 - 1.2597	32 series 1.2598 - 1.3780
0.015	0.016	0.017	0.019	0.021	0.022	0.023	0.024	0.025	0.026
0.014	0.015	0.016	0.017	0.019	0.020	0.021	0.022	0.023	0.024
0.012	0.013	0.014	0.016	0.018	0.019	0.020	0.021	0.022	0.023
0.015	0.016	0.017	0.019	0.021	0.022	0.023	0.024	0.025	0.026
0.014	0.015	0.016	0.018	0.019	0.020	0.021	0.022	0.023	0.024
0.013	0.014	0.015	0.017	0.018	0.019	0.020	0.021	0.022	0.023
0.011	0.012	0.013	0.015	0.016	0.017	0.018	0.019	0.020	0.021
0.014	0.015	0.016	0.018	0.020	0.021	0.022	0.023	0.024	0.025
0.013	0.014	0.015	0.017	0.019	0.020	0.021	0.022	0.023	0.024
0.012	0.013	0.014	0.016	0.018	0.019	0.020	0.021	0.022	0.023
0.011	0.012	0.013	0.015	0.016	0.017	0.018	0.019	0.020	0.021
0.014	0.015	0.016	0.018	0.020	0.021	0.022	0.023	0.024	0.025
0.013	0.014	0.015	0.017	0.019	0.020	0.021	0.022	0.023	0.024
0.012	0.013	0.014	0.016	0.018	0.019	0.020	0.021	0.022	0.023
0.010	0.011	0.012	0.014	0.015	0.016	0.017	0.018	0.019	0.020
0.009	0.010	0.011	0.013	0.014	0.015	0.016	0.017	0.018	0.019
0.011	0.012	0.013	0.014	0.015	0.016	0.017	0.018	0.019	0.020
0.010	0.011	0.011	0.012	0.013	0.014	0.015	0.016	0.017	0.018
0.009	0.010	0.010	0.011	0.012	0.013	0.014	0.015	0.016	0.017
0.013	0.015	0.015	0.017	0.019	0.021	0.022	0.023	0.024	0.025
0.012	0.013	0.014	0.015	0.017	0.019	0.020	0.021	0.022	0.023
0.011	0.012	0.013	0.014	0.015	0.017	0.019	0.020	0.021	0.022
0.008	0.009	0.009	0.010	0.011	0.012	0.013	0.014	0.015	0.016
0.007	0.008	0.008	0.009	0.010	0.011	0.012	0.013	0.014	0.015
0.008	0.009	0.009	0.010	0.011	0.011	0.012	0.012	0.013	0.014
0.007	0.008	0.008	0.009	0.010	0.010	0.011	0.011	0.012	0.013
0.008	0.009	0.009	0.010	0.011	0.011	0.012	0.012	0.013	0.014
0.007	0.008	0.008	0.009	0.010	0.010	0.011	0.011	0.012	0.012
0.006	0.006	0.007	0.007	0.008	0.008	0.009	0.010	0.011	0.012
0.005	0.006	0.006	0.006	0.007	0.008	0.008	0.009	0.010	0.011
0.008	0.009	0.010	0.011	0.012	0.013	0.014	0.015	0.016	0.017
0.007	0.008	0.009	0.010	0.011	0.012	0.013	0.014	0.015	0.016
0.006	0.007	0.007	0.008	0.008	0.009	0.009	0.010	0.010	0.011
0.005	0.006	0.006	0.007	0.007	0.008	0.008	0.009	0.009	0.010
0.004	0.005	0.005	0.006	0.006	0.007	0.008	0.008	0.008	0.010
0.004	0.004	0.005	0.005	0.006	0.006	0.007	0.007	0.008	0.008

Coolant Recommendations

Series	Stub, 3xD, 5xD		7xD		10xD	
	Pressure PSI	Flow Rate GPM	Pressure PSI	Flow Rate GPM	Pressure PSI	Flow Rate GPM
11	450	5	600	8	800	10
12	450	5	600	8	800	10
13	400	6	500	9.5	750	12
14	400	7	500	9.5	750	12
15	380	7	475	11	700	14
16	380	8	475	12	700	15
17	350	8	450	12.5	650	16.5
18	350	9	450	12.5	650	16.5
20	300	10	400	13	600	18
22	300	11	400	14	600	18
24	300	11	400	14	600	18
26	300	12	400	16	600	20
29	300	12	400	16	600	20
32	300	12	400	16	600	20

Recommended Drilling Data | Imperial (inch)

GEN3SYS XT Pro

ISO	Material	Hardness (BHN)	Speed (SFM)	Feed Rate (IPR) by Diameter			
				11 series 0.4331 - 0.4723	12 series 0.4724 - 0.5117	13 series 0.5118 - 0.5511	14 series 0.5512 - 0.5905
H	Wear Plate Hardox, AR400, T-1, etc.	400	160	0.005	0.005	0.006	0.006
		500	130	0.004	0.004	0.005	0.006
		600	90	0.004	0.004	0.004	0.005
	Hardened Steel	300 - 400	170	0.005	0.005	0.006	0.006
400 - 500		130	0.004	0.004	0.005	0.006	
K	SG / Nodular Cast Iron	120 - 150	550	0.010	0.012	0.013	0.014
		150 - 200	520	0.010	0.011	0.012	0.013
		200 - 220	465	0.008	0.010	0.011	0.012
		220 - 260	405	0.008	0.009	0.010	0.011
		260 - 320	365	0.008	0.008	0.009	0.010
	Grey / White Iron	120 - 150	575	0.012	0.013	0.014	0.015
		150 - 200	550	0.011	0.012	0.013	0.014
		200 - 220	495	0.010	0.011	0.012	0.013
		220 - 260	425	0.009	0.010	0.011	0.012
		260 - 320	380	0.009	0.010	0.011	0.012
N	Cast Aluminum	30	1150	0.012	0.013	0.014	0.015
		180	860	0.011	0.012	0.013	0.014
	Wrought Aluminum	30	1600	0.013	0.015	0.016	0.017
		180	1150	0.012	0.014	0.015	0.016
	Aluminum Bronze	100 - 200	415	0.010	0.011	0.012	0.012
		200 - 250	335	0.008	0.009	0.010	0.011
Brass	100	755	0.010	0.012	0.013	0.014	
Copper	60	490	0.003	0.003	0.003	0.004	

7xD Adjustment Example (0.80 Adjustment)

Data • Adjustment Value	Speed/Feed (7xD)
200 SFM • 0.80	= 160 SFM
0.008 IPR • 0.80	= 0.0064 IPR

10xD Adjustment Example (0.70 Adjustment)

Speed • Adjustment Value	Speed/Feed (10xD)
200 SFM • 0.70	= 140 SFM
0.008 IPR • 0.70	= 0.0056 IPR

⚠ WARNING Tool failure can cause serious injury. To prevent:

- When using holders without support bushing, use a short GEN3SYS holder to establish an initial hole that is a minimum of 2 diameters deep.
- Do not rotate tool holders more than 50 RPM unless it is engaged with the workpiece or fixture.

Visit www.alliedmachine.com/DeepHoleGuidelines for the most up-to-date information and procedures. Factory technical assistance is available for your specific applications through our Application Engineering Team.

IMPORTANT: The speeds and feeds listed above are a general starting point for all applications. Refer to the coolant recommendation charts for coolant requirements to run at the recommended speeds and feeds. Factory technical assistance is available through our Application Engineering department. For 7xD and 10xD holder lengths, see adjustment example above.

A
DRILLING
B
BORING
C
REAMING
D
BURNISHING
E
THREADING
X
SPECIALS

Feed Rate (IPR) by Diameter									
15 series 0.5906 - 0.6298	16 series 0.6299 - 0.6692	17 series 0.6693 - 0.7086	18 series 0.7087 - 0.7873	20 series 0.7874 - 0.8660	22 series 0.8661 - 0.9448	24 series 0.9449 - 1.0235	26 series 1.0236 - 1.1416	29 series 1.1417 - 1.2597	32 series 1.2598 - 1.3780
0.007	0.008	0.009	0.010	0.010	0.010	0.011	0.011	0.012	0.012
0.006	0.007	0.008	0.009	0.010	0.010	0.010	0.010	0.011	0.011
0.006	0.006	0.007	0.008	0.009	0.009	0.010	0.010	0.010	0.010
0.007	0.008	0.008	0.009	0.010	0.010	0.010	0.010	0.011	0.011
0.006	0.007	0.008	0.008	0.009	0.009	0.010	0.010	0.010	0.010
0.015	0.016	0.018	0.020	0.020	0.022	0.022	0.024	0.025	0.026
0.014	0.015	0.017	0.019	0.020	0.020	0.022	0.022	0.024	0.024
0.013	0.014	0.016	0.018	0.019	0.020	0.020	0.022	0.022	0.023
0.012	0.013	0.015	0.017	0.018	0.019	0.020	0.020	0.022	0.022
0.011	0.012	0.014	0.015	0.017	0.018	0.019	0.020	0.020	0.021
0.016	0.017	0.019	0.021	0.022	0.023	0.024	0.025	0.026	0.027
0.015	0.016	0.018	0.020	0.021	0.022	0.023	0.024	0.025	0.026
0.014	0.015	0.017	0.020	0.020	0.021	0.022	0.023	0.024	0.025
0.013	0.014	0.016	0.018	0.019	0.020	0.021	0.022	0.023	0.024
0.013	0.014	0.015	0.017	0.018	0.019	0.020	0.021	0.022	0.023
0.016	0.017	0.018	0.019	0.020	0.021	0.022	0.023	0.024	0.025
0.015	0.016	0.017	0.018	0.019	0.020	0.021	0.022	0.023	0.023
0.018	0.019	0.020	0.022	0.023	0.024	0.026	0.027	0.029	0.030
0.017	0.018	0.019	0.021	0.022	0.023	0.025	0.026	0.028	0.029
0.013	0.014	0.015	0.015	0.016	0.017	0.018	0.019	0.019	0.019
0.012	0.012	0.013	0.014	0.015	0.016	0.017	0.018	0.018	0.019
0.015	0.016	0.017	0.019	0.020	0.022	0.023	0.024	0.026	0.026
0.005	0.006	0.006	0.007	0.008	0.008	0.008	0.010	0.010	0.011

Coolant Recommendations

Series	Stub, 3xD, 5xD		7xD		10xD	
	Pressure PSI	Flow Rate GPM	Pressure PSI	Flow Rate GPM	Pressure PSI	Flow Rate GPM
11	450	5	600	8	800	10
12	450	5	600	8	800	10
13	400	6	500	9.5	750	12
14	400	7	500	9.5	750	12
15	380	7	475	11	700	14
16	380	8	475	12	700	15
17	350	8	450	12.5	650	16.5
18	350	9	450	12.5	650	16.5
20	300	10	400	13	600	18
22	300	11	400	14	600	18
24	300	11	400	14	600	18
26	300	12	400	16	600	20
29	300	12	400	16	600	20
32	300	12	400	16	600	20

Recommended Drilling Data | Imperial (inch)

GEN3SYS XT

ISO	Material	Hardness (BHN)	Speed (SFM)	Feed Rate (IPR) by Diameter			
				11 series 0.4331 - 0.4723	12 series 0.4724 - 0.5117	13 series 0.5118 - 0.5511	14 series 0.5512 - 0.5905
P	Free Machining Steel 1118, 1215, 12L14, etc.	100 - 150	480	0.009	0.011	0.012	0.013
		150 - 200	415	0.009	0.010	0.011	0.012
		200 - 250	390	0.007	0.008	0.009	0.010
	Low Carbon Steel 1010, 1020, 1025, 1522, 1144, etc.	85 - 125	450	0.010	0.011	0.012	0.013
		125 - 175	390	0.009	0.010	0.011	0.012
		175 - 225	355	0.008	0.009	0.010	0.011
	Medium Carbon Steel 1030, 1040, 1050, 1527, 1140, 1151, etc.	225 - 275	310	0.006	0.007	0.008	0.009
		125 - 175	390	0.009	0.010	0.011	0.012
		175 - 225	355	0.008	0.009	0.010	0.011
	Alloy Steel 4140, 5140, 8640, etc.	225 - 275	310	0.007	0.008	0.009	0.010
		275 - 325	265	0.006	0.007	0.008	0.009
		125 - 175	375	0.009	0.010	0.011	0.012
		175 - 225	345	0.008	0.009	0.010	0.011
	High Strength Alloy 4340, 4330V, 300M, etc.	225 - 275	310	0.007	0.008	0.009	0.010
		275 - 325	285	0.006	0.006	0.007	0.008
		325 - 375	255	0.006	0.006	0.006	0.007
	Structural Steel A36, A285, A516, etc.	100 - 150	355	0.009	0.010	0.011	0.012
		150 - 250	285	0.007	0.008	0.009	0.010
		250 - 350	265	0.006	0.007	0.008	0.009
	Tool Steel H-13, H-21, A-4, O-2, S-3, etc.	150 - 200	255	0.006	0.006	0.006	0.007
200 - 250		195	0.005	0.006	0.006	0.006	
S	High Temp Alloy Hastelloy B, Inconel 600, etc.	140 - 220	120	0.006	0.006	0.006	0.007
		220 - 310	95	0.005	0.006	0.006	0.006
	Titanium Alloy	140 - 220	140	0.005	0.006	0.006	0.007
		220 - 310	110	0.004	0.005	0.006	0.006
	Aerospace Alloy S82	185 - 275	145	0.004	0.004	0.005	0.005
275 - 350		120	0.003	0.003	0.004	0.005	
M	Stainless Steel 400 Series 416, 420, etc.	185 - 275	240	0.006	0.007	0.007	0.008
		275 - 350	185	0.005	0.006	0.006	0.007
	Stainless Steel 300 Series 304, 316, 17-4PH, etc.	135 - 185	220	0.004	0.005	0.005	0.006
		185 - 275	160	0.003	0.004	0.004	0.005
	Super Duplex Stainless Steel	135 - 185	125	0.003	0.003	0.003	0.004
185 - 275		100	0.002	0.002	0.003	0.003	

7xD Adjustment Example (0.80 Adjustment)

Data • Adjustment Value	Speed/Feed (7xD)
200 SFM • 0.80	= 160 SFM
0.008 IPR • 0.80	= 0.0064 IPR

10xD Adjustment Example (0.70 Adjustment)

Speed • Adjustment Value	Speed/Feed (10xD)
200 SFM • 0.70	= 140 SFM
0.008 IPR • 0.70	= 0.0056 IPR

⚠ WARNING Tool failure can cause serious injury. To prevent:

- When using holders without support bushing, use a short GEN3SYS holder to establish an initial hole that is a minimum of 2 diameters deep.
- Do not rotate tool holders more than 50 RPM unless it is engaged with the workpiece or fixture.

Visit www.alliedmachine.com/DeepHoleGuidelines for the most up-to-date information and procedures. Factory technical assistance is available for your specific applications through our Application Engineering Team.

IMPORTANT: The speeds and feeds listed above are a general starting point for all applications. Refer to the coolant recommendation charts for coolant requirements to run at the recommended speeds and feeds. Factory technical assistance is available through our Application Engineering department. For 7xD and 10xD holder lengths, see adjustment example above.

A
DRILLING
B
BORING
C
REAMING
D
BURNISHING
E
THREADING
X
SPECIALS

Feed Rate (IPR) by Diameter									
15 series 0.5906 - 0.6298	16 series 0.6299 - 0.6692	17 series 0.6693 - 0.7086	18 series 0.7087 - 0.7873	20 series 0.7874 - 0.8660	22 series 0.8661 - 0.9448	24 series 0.9449 - 1.0235	26 series 1.0236 - 1.1416	29 series 1.1417 - 1.2597	32 series 1.2598 - 1.3780
0.014	0.015	0.016	0.017	0.019	0.020	0.021	0.022	0.023	0.024
0.013	0.014	0.015	0.016	0.017	0.018	0.019	0.020	0.021	0.022
0.011	0.012	0.013	0.015	0.017	0.017	0.018	0.019	0.020	0.021
0.014	0.015	0.016	0.017	0.019	0.020	0.021	0.022	0.023	0.024
0.013	0.014	0.015	0.016	0.017	0.018	0.019	0.020	0.021	0.022
0.012	0.013	0.014	0.015	0.016	0.017	0.018	0.019	0.020	0.021
0.010	0.011	0.012	0.014	0.015	0.016	0.017	0.017	0.018	0.019
0.013	0.014	0.015	0.017	0.018	0.019	0.020	0.021	0.022	0.023
0.012	0.013	0.014	0.016	0.017	0.018	0.019	0.020	0.021	0.022
0.011	0.012	0.013	0.015	0.016	0.017	0.018	0.019	0.020	0.021
0.010	0.011	0.012	0.014	0.015	0.016	0.017	0.017	0.018	0.019
0.013	0.014	0.015	0.017	0.018	0.019	0.020	0.021	0.022	0.023
0.012	0.013	0.014	0.016	0.017	0.018	0.019	0.020	0.021	0.022
0.011	0.012	0.013	0.015	0.015	0.017	0.018	0.019	0.020	0.021
0.009	0.010	0.011	0.013	0.014	0.015	0.016	0.017	0.018	0.018
0.008	0.009	0.010	0.012	0.013	0.014	0.015	0.016	0.017	0.017
0.010	0.011	0.012	0.013	0.014	0.015	0.016	0.017	0.017	0.018
0.009	0.010	0.010	0.011	0.012	0.013	0.014	0.015	0.016	0.017
0.008	0.009	0.009	0.010	0.011	0.012	0.013	0.014	0.015	0.016
0.012	0.014	0.014	0.016	0.017	0.019	0.020	0.021	0.022	0.023
0.011	0.012	0.013	0.014	0.016	0.017	0.018	0.019	0.020	0.021
0.010	0.011	0.012	0.013	0.014	0.016	0.017	0.018	0.019	0.020
0.007	0.008	0.008	0.009	0.010	0.011	0.012	0.013	0.014	0.015
0.006	0.007	0.007	0.008	0.009	0.010	0.011	0.012	0.013	0.014
0.007	0.008	0.008	0.009	0.010	0.010	0.011	0.011	0.012	0.013
0.006	0.007	0.007	0.008	0.009	0.009	0.010	0.010	0.011	0.012
0.007	0.008	0.008	0.009	0.010	0.010	0.011	0.011	0.012	0.013
0.006	0.007	0.007	0.008	0.009	0.009	0.010	0.010	0.011	0.011
0.006	0.006	0.006	0.006	0.007	0.007	0.008	0.009	0.010	0.011
0.005	0.006	0.006	0.006	0.006	0.007	0.007	0.008	0.009	0.010
0.008	0.009	0.010	0.011	0.012	0.013	0.014	0.015	0.016	0.017
0.007	0.008	0.009	0.010	0.011	0.012	0.013	0.014	0.015	0.016
0.006	0.007	0.007	0.008	0.008	0.009	0.009	0.010	0.010	0.011
0.005	0.006	0.006	0.007	0.007	0.008	0.008	0.009	0.009	0.010
0.004	0.005	0.005	0.006	0.006	0.007	0.008	0.008	0.008	0.010
0.004	0.004	0.005	0.005	0.006	0.006	0.007	0.007	0.008	0.008

Coolant Recommendations

Series	Stub, 3xD, 5xD		7xD		10xD	
	Pressure PSI	Flow Rate GPM	Pressure PSI	Flow Rate GPM	Pressure PSI	Flow Rate GPM
11	450	5	600	8	800	10
12	450	5	600	8	800	10
13	400	6	500	9.5	750	12
14	400	7	500	9.5	750	12
15	380	7	475	11	700	14
16	380	8	475	12	700	15
17	350	8	450	12.5	650	16.5
18	350	9	450	12.5	650	16.5
20	300	10	400	13	600	18
22	300	11	400	14	600	18
24	300	11	400	14	600	18
26	300	12	400	16	600	20
29	300	12	400	16	600	20
32	300	12	400	16	600	20

Recommended Drilling Data | Imperial (inch)

GEN3SYS XT

ISO	Material	Hardness (BHN)	Speed (SFM)	Feed Rate (IPR) by Diameter			
				11 series 0.4331 - 0.4723	12 series 0.4724 - 0.5117	13 series 0.5118 - 0.5511	14 series 0.5512 - 0.5905
H	Wear Plate Hardox, AR400, T-1, etc.	400	145	0.005	0.005	0.006	0.006
		500	110	0.004	0.004	0.005	0.006
		600	80	0.004	0.004	0.004	0.005
	Hardened Steel	300 - 400	155	0.005	0.005	0.006	0.006
400 - 500		120	0.004	0.004	0.005	0.006	
K	SG / Nodular Cast Iron	120 - 150	480	0.009	0.011	0.012	0.013
		150 - 200	450	0.009	0.010	0.011	0.012
		200 - 220	400	0.007	0.009	0.010	0.011
		220 - 260	350	0.007	0.008	0.009	0.010
		260 - 320	320	0.007	0.007	0.008	0.009
	Grey / White Iron	120 - 150	500	0.011	0.012	0.013	0.014
		150 - 200	480	0.010	0.011	0.012	0.013
		200 - 220	430	0.009	0.010	0.011	0.012
		220 - 260	370	0.008	0.009	0.010	0.011
		260 - 320	335	0.008	0.009	0.010	0.011
N	Cast Aluminum	30	1000	0.011	0.012	0.013	0.014
		180	750	0.010	0.011	0.012	0.013
	Wrought Aluminum	30	1400	0.012	0.014	0.015	0.016
		180	1000	0.011	0.013	0.014	0.015
	Aluminum Bronze	100 - 200	360	0.009	0.010	0.011	0.011
		200 - 250	295	0.007	0.008	0.009	0.010
	Brass	100	660	0.009	0.011	0.012	0.013
Copper	60	425	0.003	0.003	0.003	0.004	

7xD Adjustment Example (0.80 Adjustment)

Data • Adjustment Value	Speed/Feed (7xD)
200 SFM • 0.80	= 160 SFM
0.008 IPR • 0.80	= 0.0064 IPR

10xD Adjustment Example (0.70 Adjustment)

Speed • Adjustment Value	Speed/Feed (10xD)
200 SFM • 0.70	= 140 SFM
0.008 IPR • 0.70	= 0.0056 IPR

⚠ WARNING Tool failure can cause serious injury. To prevent:

- When using holders without support bushing, use a short GEN3SYS holder to establish an initial hole that is a minimum of 2 diameters deep.
- Do not rotate tool holders more than 50 RPM unless it is engaged with the workpiece or fixture.

Visit www.alliedmachine.com/DeepHoleGuidelines for the most up-to-date information and procedures. Factory technical assistance is available for your specific applications through our Application Engineering Team.

IMPORTANT: The speeds and feeds listed above are a general starting point for all applications. Refer to the coolant recommendation charts for coolant requirements to run at the recommended speeds and feeds. Factory technical assistance is available through our Application Engineering department. For 7xD and 10xD holder lengths, see adjustment example above.

A
DRILLING
B
BORING
C
REAMING
D
BURNISHING
E
THREADING
X
SPECIALS

Feed Rate (IPR) by Diameter									
15 series 0.5906 - 0.6298	16 series 0.6299 - 0.6692	17 series 0.6693 - 0.7086	18 series 0.7087 - 0.7873	20 series 0.7874 - 0.8660	22 series 0.8661 - 0.9448	24 series 0.9449 - 1.0235	26 series 1.0236 - 1.1416	29 series 1.1417 - 1.2597	32 series 1.2598 - 1.3780
0.006	0.007	0.008	0.009	0.009	0.009	0.010	0.010	0.011	0.011
0.006	0.006	0.007	0.008	0.009	0.009	0.009	0.009	0.010	0.010
0.006	0.006	0.006	0.007	0.008	0.008	0.009	0.009	0.009	0.009
0.006	0.007	0.007	0.008	0.009	0.009	0.009	0.009	0.010	0.010
0.006	0.006	0.007	0.007	0.008	0.008	0.009	0.009	0.009	0.009
0.014	0.015	0.017	0.018	0.018	0.020	0.020	0.022	0.023	0.024
0.013	0.014	0.016	0.017	0.018	0.018	0.020	0.020	0.022	0.022
0.012	0.013	0.015	0.016	0.017	0.018	0.018	0.020	0.020	0.021
0.011	0.012	0.014	0.015	0.016	0.017	0.018	0.018	0.020	0.020
0.010	0.011	0.013	0.014	0.015	0.016	0.017	0.018	0.018	0.019
0.015	0.016	0.018	0.019	0.020	0.021	0.022	0.023	0.024	0.025
0.014	0.015	0.017	0.018	0.019	0.020	0.021	0.022	0.023	0.024
0.013	0.014	0.016	0.018	0.018	0.019	0.020	0.021	0.022	0.023
0.012	0.013	0.015	0.017	0.017	0.018	0.019	0.020	0.021	0.022
0.012	0.013	0.014	0.016	0.016	0.017	0.018	0.019	0.020	0.021
0.015	0.016	0.017	0.017	0.018	0.019	0.020	0.021	0.022	0.023
0.014	0.015	0.016	0.016	0.017	0.018	0.019	0.020	0.021	0.021
0.017	0.017	0.018	0.020	0.021	0.022	0.024	0.025	0.027	0.028
0.016	0.016	0.017	0.019	0.020	0.021	0.023	0.024	0.026	0.027
0.012	0.013	0.014	0.014	0.015	0.016	0.017	0.017	0.017	0.017
0.011	0.011	0.012	0.013	0.014	0.015	0.016	0.016	0.016	0.016
0.014	0.015	0.016	0.017	0.018	0.020	0.021	0.022	0.024	0.024
0.005	0.006	0.006	0.006	0.007	0.007	0.007	0.009	0.009	0.010

Coolant Recommendations

Series	Stub, 3xD, 5xD		7xD		10xD	
	Pressure PSI	Flow Rate GPM	Pressure PSI	Flow Rate GPM	Pressure PSI	Flow Rate GPM
11	450	5	600	8	800	10
12	450	5	600	8	800	10
13	400	6	500	9.5	750	12
14	400	7	500	9.5	750	12
15	380	7	475	11	700	14
16	380	8	475	12	700	15
17	350	8	450	12.5	650	16.5
18	350	9	450	12.5	650	16.5
20	300	10	400	13	600	18
22	300	11	400	14	600	18
24	300	11	400	14	600	18
26	300	12	400	16	600	20
29	300	12	400	16	600	20
32	300	12	400	16	600	20

Recommended Drilling Data | Metric (mm)

GEN3SYS XT Pro

ISO	Material	Hardness (BHN)	Speed (M/mm)	Feed Rate (mm/rev) by Diameter			
				11 series 11.00 - 11.99	12 series 12.00 - 12.99	13 series 13.00 - 13.99	14 series 14.00 - 14.99
P	Free Machining Steel 1118, 1215, 12L14, etc.	100 - 150	168	0.28	0.30	0.33	0.36
		150 - 200	145	0.25	0.28	0.30	0.33
		200 - 250	130	0.20	0.23	0.25	0.28
	Low Carbon Steel 1010, 1020, 1025, 1522, 1144, etc.	85 - 125	158	0.28	0.3	0.33	0.36
		125 - 175	137	0.25	0.28	0.30	0.33
		175 - 225	125	0.23	0.25	0.28	0.30
	Medium Carbon Steel 1030, 1040, 1050, 1527, 1140, 1151, etc.	225 - 275	107	0.18	0.20	0.23	0.25
		125 - 175	137	0.25	0.28	0.30	0.33
		175 - 225	125	0.23	0.25	0.28	0.30
	Alloy Steel 4140, 5140, 8640, etc.	225 - 275	107	0.20	0.23	0.25	0.28
		275 - 325	91	0.18	0.20	0.23	0.25
		125 - 175	126	0.25	0.28	0.30	0.33
		175 - 225	116	0.23	0.25	0.28	0.30
	High Strength Alloy 4340, 4330V, 300M, etc.	225 - 275	104	0.20	0.23	0.25	0.28
		275 - 325	94	0.15	0.18	0.20	0.23
		325 - 375	85	0.15	0.15	0.18	0.20
	Structural Steel A36, A285, A516, etc.	300 - 350	69	0.15	0.18	0.20	0.23
		350 - 400	61	0.13	0.18	0.18	0.20
100 - 150		125	0.25	0.28	0.30	0.33	
Tool Steel H-13, H-21, A-4, O-2, S-3, etc.	150 - 250	101	0.20	0.23	0.25	0.28	
	250 - 350	93	0.18	0.20	0.23	0.25	
S	High Temp Alloy Hastelloy B, Inconel 600, etc.	150 - 200	81	0.15	0.18	0.18	0.20
		200 - 250	62	0.13	0.15	0.15	0.18
	Titanium Alloy	140 - 220	40	0.15	0.18	0.18	0.20
		220 - 310	30	0.13	0.15	0.15	0.18
	Aerospace Alloy S82	140 - 220	43	0.13	0.15	0.18	0.20
220 - 310		34	0.10	0.13	0.15	0.18	
M	Stainless Steel 400 Series 416, 420, etc.	185 - 275	50	0.10	0.10	0.12	0.14
		275 - 350	41	0.09	0.09	0.10	0.12
	Stainless Steel 300 Series 304, 316, 17-4PH, etc.	185 - 275	73	0.15	0.18	0.18	0.20
		275 - 350	56	0.13	0.15	0.15	0.18
	Super Duplex Stainless Steel	135 - 185	64	0.10	0.13	0.13	0.15
135 - 185		47	0.08	0.10	0.10	0.13	
185 - 275	38	0.08	0.08	0.08	0.10		
185 - 275	30	0.05	0.05	0.08	0.08		

7xD Adjustment Example (0.80 Adjustment)

Data • Adjustment Value	Speed/Feed (7xD)
61 M/min • 0.80	= 48.8 M/min
0.20 mm/rev • 0.80	= 0.16 mm/rev

10xD Adjustment Example (0.70 Adjustment)

Speed • Adjustment Value	Speed/Feed (10xD)
61 M/min • 0.70	= 42.7 M/min
0.20 mm/rev • 0.70	= 0.14 mm/rev

⚠ WARNING Tool failure can cause serious injury. To prevent:

- When using holders without support bushing, use a short GEN3SYS holder to establish an initial hole that is a minimum of 2 diameters deep.
- Do not rotate tool holders more than 50 RPM unless it is engaged with the workpiece or fixture.

Visit www.alliedmachine.com/DeepHoleGuidelines for the most up-to-date information and procedures. Factory technical assistance is available for your specific applications through our Application Engineering Team.

IMPORTANT: The speeds and feeds listed above are a general starting point for all applications. Refer to the coolant recommendation charts for coolant requirements to run at the recommended speeds and feeds. Factory technical assistance is available through our Application Engineering department. For 7xD and 10xD holder lengths, see adjustment example above.

A
DRILLING
B
BORING
C
REAMING
D
BURNISHING
E
THREADING
X
SPECIALS

Feed Rate (mm/rev) by Diameter									
15 series 15.00 - 15.99	16 series 16.00 - 16.99	17 series 17.00 - 17.99	18 series 18.00 - 19.99	20 series 20.00 - 21.99	22 series 22.00 - 23.99	24 series 24.00 - 25.99	26 series 26.00 - 28.99	29 series 29.00 - 31.99	32 series 32.00 - 35.00
0.38	0.41	0.43	0.48	0.53	0.56	0.58	0.61	0.64	0.66
0.36	0.38	0.41	0.43	0.48	0.51	0.53	0.56	0.58	0.61
0.30	0.33	0.36	0.41	0.46	0.48	0.51	0.53	0.56	0.58
0.38	0.41	0.43	0.48	0.53	0.56	0.58	0.61	0.64	0.66
0.36	0.38	0.41	0.46	0.48	0.51	0.53	0.56	0.58	0.61
0.33	0.36	0.38	0.42	0.46	0.48	0.51	0.53	0.56	0.58
0.28	0.30	0.33	0.38	0.41	0.42	0.46	0.48	0.51	0.53
0.36	0.38	0.41	0.46	0.51	0.53	0.56	0.58	0.61	0.64
0.33	0.36	0.38	0.43	0.48	0.51	0.53	0.56	0.58	0.61
0.30	0.33	0.36	0.41	0.46	0.48	0.51	0.53	0.56	0.58
0.28	0.30	0.33	0.38	0.41	0.43	0.46	0.48	0.51	0.53
0.36	0.38	0.41	0.46	0.51	0.53	0.56	0.58	0.61	0.64
0.33	0.36	0.38	0.43	0.48	0.51	0.53	0.56	0.58	0.61
0.30	0.33	0.36	0.41	0.46	0.48	0.51	0.53	0.56	0.58
0.25	0.28	0.30	0.36	0.38	0.41	0.43	0.46	0.48	0.51
0.23	0.25	0.28	0.33	0.36	0.38	0.41	0.43	0.46	0.48
0.28	0.30	0.33	0.36	0.38	0.41	0.43	0.46	0.48	0.51
0.25	0.28	0.28	0.30	0.33	0.36	0.38	0.41	0.43	0.46
0.23	0.25	0.25	0.28	0.30	0.33	0.36	0.38	0.41	0.43
0.33	0.38	0.38	0.43	0.48	0.53	0.56	0.58	0.61	0.64
0.30	0.33	0.36	0.38	0.43	0.48	0.51	0.53	0.56	0.58
0.28	0.30	0.33	0.36	0.38	0.43	0.48	0.51	0.53	0.56
0.20	0.23	0.23	0.25	0.28	0.30	0.33	0.36	0.38	0.41
0.18	0.20	0.20	0.23	0.25	0.28	0.30	0.33	0.36	0.38
0.20	0.23	0.23	0.25	0.28	0.28	0.30	0.30	0.33	0.36
0.18	0.20	0.20	0.23	0.25	0.25	0.28	0.28	0.30	0.33
0.20	0.23	0.23	0.25	0.28	0.28	0.30	0.30	0.33	0.33
0.18	0.20	0.20	0.23	0.25	0.25	0.28	0.28	0.30	0.30
0.15	0.16	0.18	0.18	0.20	0.22	0.24	0.26	0.28	0.31
0.14	0.15	0.16	0.16	0.18	0.20	0.22	0.24	0.26	0.29
0.20	0.23	0.25	0.28	0.30	0.33	0.36	0.38	0.41	0.43
0.18	0.20	0.23	0.25	0.28	0.30	0.33	0.36	0.38	0.41
0.15	0.18	0.18	0.20	0.20	0.23	0.23	0.25	0.25	0.28
0.13	0.15	0.15	0.18	0.18	0.20	0.20	0.23	0.23	0.25
0.10	0.13	0.13	0.15	0.15	0.18	0.20	0.20	0.20	0.25
0.10	0.10	0.13	0.13	0.15	0.15	0.18	0.18	0.20	0.20

Coolant Recommendations

Series	Stub, 3xD, 5xD		7xD		10xD	
	Pressure BAR	Flow Rate LPM	Pressure BAR	Flow Rate LPM	Pressure BAR	Flow Rate LPM
11	31	19	41	30	55	38
12	31	19	41	30	55	38
13	28	23	34	36	52	45
14	28	26	34	36	52	45
15	26	26	33	42	48	53
16	26	30	33	45	48	57
17	24	30	31	47	45	62
18	24	34	31	47	45	62
20	21	38	28	49	41	68
22	21	42	28	53	41	68
24	21	42	28	53	41	68
26	21	45	28	61	41	76
29	21	45	28	61	41	76
32	21	45	28	61	41	76

Recommended Drilling Data | Metric (mm)

GEN3SYS XT Pro

ISO	Material	Hardness (BHN)	Speed (M/min)	Feed Rate (mm/rev) by Diameter			
				11 series 11.00 - 11.99	12 series 12.00 - 12.99	13 series 13.00 - 13.99	14 series 14.00 - 14.99
H	Wear Plate Hardox, AR400, T-1, etc.	400	50	0.13	0.13	0.15	0.17
		500	40	0.11	0.11	0.13	0.15
		600	27	0.10	0.10	0.11	0.13
	Hardened Steel	300 - 400	51	0.13	0.13	0.15	0.17
		400 - 500	40	0.11	0.11	0.13	0.15
K	SG / Nodular Cast Iron	120 - 150	168	0.27	0.30	0.33	0.36
		150 - 200	159	0.25	0.28	0.30	0.33
		200 - 220	141	0.22	0.25	0.28	0.30
		220 - 260	124	0.20	0.23	0.25	0.28
		260 - 320	112	0.20	0.21	0.23	0.25
	Grey / White Iron	120 - 150	175	0.30	0.33	0.36	0.38
		150 - 200	168	0.28	0.30	0.33	0.36
		200 - 220	151	0.25	0.28	0.30	0.33
		220 - 260	130	0.23	0.25	0.28	0.30
		260 - 320	116	0.23	0.25	0.28	0.30
N	Cast Aluminum	30	351	0.30	0.33	0.36	0.38
		180	262	0.28	0.30	0.33	0.36
	Wrought Aluminum	30	488	0.33	0.38	0.41	0.43
		180	351	0.30	0.36	0.38	0.41
	Aluminum Bronze	100 - 200	126	0.26	0.28	0.30	0.32
		200 - 250	103	0.22	0.24	0.26	0.28
	Brass	100	230	0.29	0.30	0.33	0.36
Copper	60	149	0.07	0.08	0.09	0.11	

7xD Adjustment Example (0.80 Adjustment)

Data • Adjustment Value	Speed/Feed (7xD)
61 M/min • 0.80	= 48.8 M/min
0.20 mm/rev • 0.80	= 0.16 mm/rev

10xD Adjustment Example (0.70 Adjustment)

Speed • Adjustment Value	Speed/Feed (10xD)
61 M/min • 0.70	= 42.7 M/min
0.20 mm/rev • 0.70	= 0.14 mm/rev

⚠ WARNING Tool failure can cause serious injury. To prevent:

- When using holders without support bushing, use a short GEN3SYS holder to establish an initial hole that is a minimum of 2 diameters deep.
- Do not rotate tool holders more than 50 RPM unless it is engaged with the workpiece or fixture.

Visit www.alliedmachine.com/DeepHoleGuidelines for the most up-to-date information and procedures. Factory technical assistance is available for your specific applications through our Application Engineering Team.

IMPORTANT: The speeds and feeds listed above are a general starting point for all applications. Refer to the coolant recommendation charts for coolant requirements to run at the recommended speeds and feeds. Factory technical assistance is available through our Application Engineering department. For 7xD and 10xD holder lengths, see adjustment example above.

A
DRILLING
B
BORING
C
REAMING
D
BURNISHING
E
THREADING
X
SPECIALS

Feed Rate (mm/rev) by Diameter									
15 series 15.00 - 15.99	16 series 16.00 - 16.99	17 series 17.00 - 17.99	18 series 18.00 - 19.99	20 series 20.00 - 21.99	22 series 22.00 - 23.99	24 series 24.00 - 25.99	26 series 26.00 - 28.99	29 series 29.00 - 31.99	32 series 32.00 - 35.00
0.19	0.21	0.23	0.25	0.27	0.27	0.29	0.29	0.31	0.31
0.17	0.19	0.21	0.23	0.25	0.25	0.27	0.27	0.29	0.29
0.15	0.17	0.19	0.21	0.23	0.23	0.25	0.25	0.25	0.27
0.19	0.21	0.22	0.23	0.25	0.25	0.27	0.27	0.29	0.29
0.17	0.19	0.20	0.21	0.23	0.23	0.25	0.25	0.27	0.27
0.38	0.41	0.46	0.51	0.53	0.56	0.58	0.61	0.64	0.66
0.36	0.38	0.43	0.48	0.51	0.53	0.56	0.58	0.61	0.63
0.33	0.36	0.41	0.46	0.48	0.51	0.53	0.56	0.58	0.60
0.30	0.33	0.38	0.43	0.46	0.48	0.51	0.53	0.56	0.58
0.28	0.30	0.36	0.38	0.43	0.46	0.48	0.51	0.53	0.55
0.41	0.43	0.48	0.53	0.56	0.58	0.61	0.64	0.66	0.69
0.38	0.41	0.46	0.51	0.53	0.56	0.58	0.61	0.64	0.66
0.36	0.38	0.43	0.51	0.51	0.53	0.56	0.58	0.61	0.64
0.33	0.36	0.41	0.46	0.48	0.51	0.53	0.56	0.58	0.61
0.33	0.36	0.38	0.43	0.46	0.48	0.51	0.53	0.56	0.58
0.41	0.43	0.46	0.48	0.51	0.53	0.56	0.58	0.61	0.64
0.38	0.41	0.43	0.46	0.48	0.51	0.53	0.56	0.58	0.58
0.46	0.48	0.51	0.53	0.56	0.61	0.66	0.69	0.74	0.76
0.43	0.46	0.48	0.53	0.56	0.58	0.64	0.66	0.71	0.74
0.34	0.36	0.38	0.40	0.42	0.44	0.46	0.48	0.48	0.50
0.30	0.32	0.34	0.36	0.38	0.42	0.46	0.46	0.46	0.48
0.38	0.41	0.43	0.48	0.53	0.56	0.60	0.63	0.66	0.66
0.13	0.15	0.16	0.18	0.20	0.20	0.22	0.25	0.25	0.28

Coolant Recommendations

Series	Stub, 3xD, 5xD		7xD		10xD	
	Pressure BAR	Flow Rate LPM	Pressure BAR	Flow Rate LPM	Pressure BAR	Flow Rate LPM
11	31	19	41	30	55	38
12	31	19	41	30	55	38
13	28	23	34	36	52	45
14	28	26	34	36	52	45
15	26	26	33	42	48	53
16	26	30	33	45	48	57
17	24	30	31	47	45	62
18	24	34	31	47	45	62
20	21	38	28	49	41	68
22	21	42	28	53	41	68
24	21	42	28	53	41	68
26	21	45	28	61	41	76
29	21	45	28	61	41	76
32	21	45	28	61	41	76

Recommended Drilling Data | Metric (mm)

GEN3SYS XT

ISO	Material	Hardness (BHN)	Speed (M/mm)	Feed Rate (mm/rev) by Diameter			
				11 series 11.00 - 11.99	12 series 12.00 - 12.99	13 series 13.00 - 13.99	14 series 14.00 - 14.99
P	Free Machining Steel 1118, 1215, 12L14, etc.	100 - 150	146	0.23	0.28	0.30	0.33
		150 - 200	126	0.23	0.26	0.28	0.30
		200 - 250	119	0.19	0.21	0.23	0.26
	Low Carbon Steel 1010, 1020, 1025, 1522, 1144, etc.	85 - 125	137	0.26	0.28	0.30	0.33
		125 - 175	119	0.23	0.26	0.28	0.30
		175 - 225	108	0.21	0.23	0.26	0.28
	Medium Carbon Steel 1030, 1040, 1050, 1527, 1140, 1151, etc.	225 - 275	95	0.16	0.19	0.21	0.23
		125 - 175	119	0.23	0.26	0.28	0.30
		175 - 225	108	0.21	0.23	0.26	0.28
	Alloy Steel 4140, 5140, 8640, etc.	225 - 275	95	0.19	0.21	0.23	0.26
		275 - 325	81	0.16	0.19	0.21	0.23
		125 - 175	114	0.23	0.26	0.28	0.30
		175 - 225	105	0.21	0.23	0.26	0.28
	High Strength Alloy 4340, 4330V, 300M, etc.	225 - 275	95	0.19	0.21	0.23	0.26
		275 - 325	87	0.14	0.16	0.19	0.21
		325 - 375	78	0.14	0.14	0.16	0.19
	Structural Steel A36, A285, A516, etc.	300 - 350	63	0.14	0.16	0.19	0.21
		100 - 150	108	0.23	0.26	0.28	0.30
150 - 250		87	0.19	0.21	0.23	0.26	
Tool Steel H-13, H-21, A-4, O-2, S-3, etc.	250 - 350	81	0.16	0.19	0.21	0.23	
	150 - 200	78	0.14	0.16	0.16	0.19	
S	High Temp Alloy Hastelloy B, Inconel 600, etc.	200 - 250	59	0.12	0.14	0.14	0.16
		140 - 220	37	0.14	0.16	0.16	0.19
	Titanium Alloy	220 - 310	29	0.12	0.14	0.14	0.16
		140 - 220	42	0.12	0.14	0.16	0.19
	Aerospace Alloy S82	220 - 310	33	0.09	0.12	0.14	0.16
185 - 275		45	0.09	0.09	0.12	0.12	
M	Stainless Steel 400 Series 416, 420, etc.	275 - 350	30	0.07	0.07	0.09	0.12
		185 - 275	73	0.15	0.18	0.18	0.20
	Stainless Steel 300 Series 304, 316, 17-4PH, etc.	185 - 275	47	0.08	0.10	0.10	0.13
		135 - 185	64	0.10	0.13	0.13	0.15
	Super Duplex Stainless Steel	135 - 185	38	0.08	0.08	0.08	0.10
		185 - 275	30	0.05	0.05	0.08	0.08

7xD Adjustment Example (0.80 Adjustment)

Data • Adjustment Value	Speed/Feed (7xD)
61 M/min • 0.80	= 48.8 M/min
0.20 mm/rev • 0.80	= 0.16 mm/rev

10xD Adjustment Example (0.70 Adjustment)

Speed • Adjustment Value	Speed/Feed (10xD)
61 M/min • 0.70	= 42.7 M/min
0.20 mm/rev • 0.70	= 0.14 mm/rev

⚠ WARNING Tool failure can cause serious injury. To prevent:

- When using holders without support bushing, use a short GEN3SYS holder to establish an initial hole that is a minimum of 2 diameters deep.
- Do not rotate tool holders more than 50 RPM unless it is engaged with the workpiece or fixture.

Visit www.alliedmachine.com/DeepHoleGuidelines for the most up-to-date information and procedures. Factory technical assistance is available for your specific applications through our Application Engineering Team.

IMPORTANT: The speeds and feeds listed above are a general starting point for all applications. Refer to the coolant recommendation charts for coolant requirements to run at the recommended speeds and feeds. Factory technical assistance is available through our Application Engineering department. For 7xD and 10xD holder lengths, see adjustment example above.

A
DRILLING
B
BORING
C
REAMING
D
BURNISHING
E
THREADING
X
SPECIALS

Feed Rate (mm/rev) by Diameter									
15 series 15.00 - 15.99	16 series 16.00 - 16.99	17 series 17.00 - 17.99	18 series 18.00 - 19.99	20 series 20.00 - 21.99	22 series 22.00 - 23.99	24 series 24.00 - 25.99	26 series 26.00 - 28.99	29 series 29.00 - 31.99	32 series 32.00 - 35.00
0.35	0.37	0.40	0.44	0.49	0.51	0.54	0.56	0.58	0.61
0.33	0.35	0.37	0.40	0.44	0.47	0.49	0.51	0.54	0.56
0.28	0.30	0.33	0.37	0.42	0.44	0.47	0.49	0.51	0.54
0.35	0.37	0.40	0.44	0.49	0.51	0.54	0.56	0.58	0.61
0.33	0.35	0.37	0.41	0.44	0.47	0.49	0.51	0.54	0.56
0.30	0.33	0.35	0.38	0.41	0.44	0.47	0.49	0.51	0.54
0.26	0.28	0.30	0.35	0.37	0.40	0.42	0.44	0.47	0.49
0.33	0.35	0.37	0.42	0.47	0.49	0.51	0.54	0.56	0.58
0.30	0.33	0.35	0.40	0.44	0.47	0.49	0.51	0.54	0.56
0.28	0.30	0.33	0.37	0.41	0.44	0.47	0.49	0.51	0.54
0.26	0.28	0.30	0.35	0.37	0.40	0.42	0.44	0.47	0.49
0.33	0.35	0.37	0.42	0.47	0.49	0.51	0.54	0.56	0.58
0.30	0.33	0.35	0.40	0.44	0.47	0.49	0.51	0.54	0.56
0.28	0.30	0.33	0.37	0.38	0.44	0.47	0.49	0.51	0.54
0.23	0.26	0.28	0.33	0.35	0.37	0.40	0.42	0.46	0.47
0.21	0.23	0.26	0.30	0.33	0.35	0.37	0.40	0.42	0.44
0.26	0.28	0.30	0.33	0.35	0.37	0.40	0.42	0.44	0.47
0.23	0.26	0.26	0.28	0.30	0.33	0.35	0.37	0.40	0.42
0.21	0.23	0.23	0.26	0.28	0.30	0.33	0.35	0.37	0.40
0.30	0.35	0.35	0.40	0.44	0.49	0.51	0.54	0.56	0.58
0.28	0.30	0.33	0.35	0.40	0.44	0.47	0.49	0.51	0.54
0.26	0.28	0.30	0.33	0.35	0.40	0.44	0.47	0.49	0.51
0.19	0.21	0.21	0.23	0.26	0.28	0.30	0.33	0.35	0.37
0.16	0.19	0.19	0.21	0.23	0.26	0.28	0.30	0.33	0.35
0.19	0.21	0.21	0.23	0.26	0.26	0.28	0.28	0.30	0.33
0.16	0.19	0.19	0.21	0.23	0.23	0.26	0.26	0.28	0.30
0.19	0.21	0.21	0.23	0.26	0.26	0.28	0.28	0.30	0.33
0.16	0.19	0.19	0.21	0.23	0.23	0.26	0.26	0.28	0.28
0.14	0.14	0.16	0.16	0.19	0.19	0.21	0.23	0.26	0.28
0.12	0.14	0.14	0.14	0.16	0.19	0.19	0.21	0.23	0.26
0.20	0.23	0.25	0.28	0.30	0.33	0.36	0.38	0.41	0.43
0.18	0.20	0.23	0.25	0.28	0.30	0.33	0.36	0.38	0.41
0.15	0.18	0.18	0.20	0.20	0.23	0.23	0.25	0.25	0.28
0.13	0.15	0.15	0.18	0.18	0.20	0.20	0.23	0.23	0.25
0.10	0.13	0.13	0.15	0.15	0.18	0.20	0.20	0.20	0.25
0.10	0.10	0.13	0.13	0.15	0.15	0.18	0.18	0.20	0.20

Coolant Recommendations

Series	Stub, 3xD, 5xD		7xD		10xD	
	Pressure BAR	Flow Rate LPM	Pressure BAR	Flow Rate LPM	Pressure BAR	Flow Rate LPM
11	31	19	41	30	55	38
12	31	19	41	30	55	38
13	28	23	34	36	52	45
14	28	26	34	36	52	45
15	26	26	33	42	48	53
16	26	30	33	45	48	57
17	24	30	31	47	45	62
18	24	34	31	47	45	62
20	21	38	28	49	41	68
22	21	42	28	53	41	68
24	21	42	28	53	41	68
26	21	45	28	61	41	76
29	21	45	28	61	41	76
32	21	45	28	61	41	76

Recommended Drilling Data | Metric (mm)

GEN3SYS XT

ISO	Material	Hardness (BHN)	Speed (M/min)	Feed Rate (mm/rev) by Diameter			
				11 series 11.00 - 11.99	12 series 12.00 - 12.99	13 series 13.00 - 13.99	14 series 14.00 - 14.99
H	Wear Plate Hardox, AR400, T-1, etc.	400	45	0.12	0.12	0.14	0.14
		500	37	0.09	0.09	0.12	0.14
		600	25	0.09	0.09	0.09	0.12
	Hardened Steel	300 - 400	47	0.12	0.12	0.14	0.14
		400 - 500	37	0.09	0.09	0.12	0.14
K	SG / Nodular Cast Iron	120 - 150	146	0.23	0.28	0.30	0.33
		150 - 200	138	0.23	0.26	0.28	0.30
		200 - 220	123	0.19	0.23	0.26	0.28
		220 - 260	108	0.19	0.21	0.23	0.26
		260 - 320	97	0.19	0.19	0.21	0.23
	Grey / White Iron	120 - 150	152	0.28	0.30	0.33	0.35
		150 - 200	146	0.26	0.28	0.30	0.33
		200 - 220	131	0.23	0.26	0.28	0.30
		220 - 260	113	0.21	0.23	0.26	0.28
		260 - 320	102	0.21	0.23	0.26	0.28
N	Cast Aluminum	30	300	0.28	0.30	0.33	0.35
		180	225	0.26	0.28	0.30	0.33
	Wrought Aluminum	30	425	0.30	0.35	0.37	0.40
		180	300	0.28	0.33	0.35	0.37
	Aluminum Bronze	100 - 200	110	0.23	0.26	0.28	0.28
		200 - 250	90	0.19	0.21	0.23	0.26
	Brass	100	200	0.23	0.28	0.30	0.33
Copper	60	130	0.07	0.07	0.07	0.09	

7xD Adjustment Example (0.80 Adjustment)

Data • Adjustment Value	Speed/Feed (7xD)
61 M/min • 0.80	= 48.8 M/min
0.20 mm/rev • 0.80	= 0.16 mm/rev

10xD Adjustment Example (0.70 Adjustment)

Speed • Adjustment Value	Speed/Feed (10xD)
61 M/min • 0.70	= 42.7 M/min
0.20 mm/rev • 0.70	= 0.14 mm/rev

⚠ WARNING Tool failure can cause serious injury. To prevent:

- When using holders without support bushing, use a short GEN3SYS holder to establish an initial hole that is a minimum of 2 diameters deep.
- Do not rotate tool holders more than 50 RPM unless it is engaged with the workpiece or fixture.

Visit www.alliedmachine.com/DeepHoleGuidelines for the most up-to-date information and procedures. Factory technical assistance is available for your specific applications through our Application Engineering Team.

IMPORTANT: The speeds and feeds listed above are a general starting point for all applications. Refer to the coolant recommendation charts for coolant requirements to run at the recommended speeds and feeds. Factory technical assistance is available through our Application Engineering department. For 7xD and 10xD holder lengths, see adjustment example above.

A
DRILLING
B
BORING
C
REAMING
D
BURNISHING
E
THREADING
X
SPECIALS

Feed Rate (mm/rev) by Diameter									
15 series 15.00 - 15.99	16 series 16.00 - 16.99	17 series 17.00 - 17.99	18 series 18.00 - 19.99	20 series 20.00 - 21.99	22 series 22.00 - 23.99	24 series 24.00 - 25.99	26 series 26.00 - 28.99	29 series 29.00 - 31.99	32 series 32.00 - 35.00
0.16	0.19	0.21	0.23	0.23	0.23	0.26	0.26	0.28	0.28
0.14	0.16	0.19	0.21	0.23	0.23	0.23	0.23	0.26	0.26
0.14	0.14	0.16	0.19	0.21	0.21	0.23	0.23	0.23	0.23
0.16	0.19	0.19	0.21	0.23	0.23	0.23	0.23	0.26	0.26
0.14	0.16	0.19	0.19	0.21	0.21	0.23	0.23	0.23	0.23
0.35	0.37	0.42	0.47	0.47	0.51	0.51	0.56	0.58	0.61
0.33	0.35	0.40	0.44	0.47	0.47	0.51	0.51	0.56	0.56
0.30	0.33	0.37	0.41	0.44	0.47	0.47	0.51	0.51	0.54
0.28	0.30	0.35	0.38	0.41	0.44	0.47	0.47	0.51	0.51
0.26	0.28	0.33	0.35	0.38	0.41	0.44	0.47	0.47	0.49
0.37	0.40	0.46	0.49	0.51	0.54	0.56	0.58	0.61	0.63
0.35	0.37	0.42	0.47	0.49	0.51	0.54	0.56	0.58	0.61
0.33	0.35	0.40	0.47	0.47	0.49	0.51	0.54	0.56	0.58
0.30	0.33	0.37	0.42	0.44	0.47	0.49	0.51	0.54	0.56
0.30	0.33	0.35	0.40	0.41	0.44	0.47	0.49	0.51	0.54
0.37	0.40	0.42	0.44	0.47	0.49	0.51	0.54	0.56	0.58
0.35	0.37	0.40	0.41	0.44	0.47	0.49	0.51	0.54	0.54
0.42	0.44	0.47	0.51	0.54	0.56	0.61	0.63	0.68	0.70
0.40	0.41	0.44	0.49	0.51	0.54	0.58	0.61	0.65	0.68
0.30	0.33	0.35	0.35	0.37	0.40	0.42	0.44	0.44	0.44
0.28	0.28	0.30	0.33	0.35	0.37	0.40	0.41	0.41	0.41
0.35	0.37	0.40	0.44	0.47	0.51	0.54	0.56	0.61	0.61
0.12	0.14	0.14	0.16	0.19	0.19	0.19	0.23	0.23	0.26

Coolant Recommendations

Series	Stub, 3xD, 5xD		7xD		10xD	
	Pressure BAR	Flow Rate LPM	Pressure BAR	Flow Rate LPM	Pressure BAR	Flow Rate LPM
11	31	19	41	30	55	38
12	31	19	41	30	55	38
13	28	23	34	36	52	45
14	28	26	34	36	52	45
15	26	26	33	42	48	53
16	26	30	33	45	48	57
17	24	30	31	47	45	62
18	24	34	31	47	45	62
20	21	38	28	49	41	68
22	21	42	28	53	41	68
24	21	42	28	53	41	68
26	21	45	28	61	41	76
29	21	45	28	61	41	76
32	21	45	28	61	41	76

Tap Drill Information and Formulas | Imperial (inch)

American - Unified Inch Screw Thread

Tap Size	Tap Drill Size	Decimal Equivalent	* Theo % Thread	Probable Mean Oversize	Probable Hole Size	** Probable % Thread
1/2 - 20	29/64	0.4531	72%	0.003	0.4561	68%
9/16 - 12	12.0 mm	0.4724	72%	0.003	0.4754	69%
	31/64	0.4844	83%	0.003	0.4874	80%
9/16 - 18	1/2	0.5000	87%	0.003	0.5030	82%
	13.0 mm	0.5118	70%	0.003	0.5148	66%
	31/64	0.5156	65%	0.003	0.5186	61%
5/8 - 11	17/32	0.5313	79%	0.003	0.5343	77%
5/8 - 12	35/64	0.5469	72%	0.003	0.5499	69%
5/8 - 18	9/16	0.5625	87%	0.003	0.5655	82%
	14.5 mm	0.5709	75%	0.003	0.5739	71%
	37/64	0.5781	65%	0.003	0.5811	61%
11/16 - 12	39/64	0.6094	72%	0.003	0.6124	69%
3/4 - 10	41/64	0.6406	84%	0.003	0.6436	82%
	16.5 mm	0.6496	77%	0.003	0.6526	75%
	21/32	0.6563	72%	0.003	0.6593	70%
3/4 - 12	43/64	0.6719	72%	0.003	0.6749	69%
3/4 - 16	11/16	0.6875	77%	0.003	0.6905	73%
	17.5 mm	0.6890	75%	0.003	0.6920	71%
7/8 - 9	49/64	0.7656	76%	0.003	0.7686	74%
	25/32	0.7813	65%	0.003	0.7843	63%
7/8 - 14	51/64	0.7969	84%	0.003	0.7999	81%
	13/16	0.8125	67%	0.003	0.8155	64%
15/16 - 12	55/64	0.8594	72%	0.003	0.8624	69%
15/16 - 20	57/64	0.8906	72%	0.003	0.8936	68%
1 - 8	22.0 mm	0.8661	82%	0.003	0.8691	81%
	7/8	0.8750	77%	0.003	0.8780	75%
	57/64	0.8906	67%	0.003	0.8936	65%
1 - 12	29/32	0.9063	87%	0.003	0.9093	84%
	59/64	0.9219	72%	0.003	0.9249	69%
1 - 14	15/16	0.9375	67%	0.003	0.9405	64%
1-1/8 - 12	1-1/32	1.0313	87%	0.003	1.0343	84%
	1-3/64	1.0469	72%	0.003	1.0499	69%
1-1/4 - 7	1-7/64	1.1094	76%	0.003	1.1124	74%

Taper Pipe Thread (NPT)

Tap Size	Tap Drill Size	Decimal Equivalent	* Theo % Thread	Probable Mean Oversize	Probable Hole Size	** Probable % Thread
1/4 - 18	7/16	0.4375	-	0.003	0.4405	-
3/8 - 18	9/16	0.5625	-	0.003	0.5655	-
1/2 - 14	45/64	0.7031	-	0.003	0.7061	-
3/4 - 14	29/32	0.9063	-	0.003	0.9093	-

* Based on nominal tap drill diameter

** Based on .003" probable mean oversize

To calculate the percent of full thread for a given hole diameter:

$$\% \text{ Thread} = \# \text{ of threads per inch} \cdot \frac{(\text{Basic major diameter of thread} - \text{Drill hole size})}{.0130}$$

Notes

- The above tap drill information represents probable thread percentages for the standard tap drills stocked at Allied Machine. Special insert diameters may be required in order to meet a user specific percentage of thread requirement.
- The .003 probable mean oversize hole condition is based on optimum cutting conditions. Probable percent of full thread may vary based on less ideal cutting conditions.
- The table and equations on this page are found in the *Machinery's Handbook*. Permission to simplify and print the equations is granted by the Editor of the *Machinery's Handbook*.

Formulas

1.	RPM	= (3.82 • SFM) / DIA
	where:	
	RPM	= revolutions per minute (rev/min)
	SFM	= speed (ft/min)
	DIA	= diameter of drill (inch)
2.	IPM	= RPM • IPR
	where:	
	IPM	= inches per minute (in/min)
	RPM	= revolutions per minute (rev/min)
	IPR	= feed rate (in/rev)
3.	SFM	= RPM • 0.262 • DIA
	where:	
	SFM	= speed (ft/min)
	RPM	= revolutions per minute (rev/min)
	DIA	= diameter of drill (inch)
4.	Thrust	= 153,700 • IPR • DIA • Km
	where:	
	Thrust	= axial thrust (lbs)
	IPR	= feed rate (in/rev)
	DIA	= diameter of drill (inch)
	Km	= specific cutting energy (lbs/in ²)
5.	Tool Power	= .6991 • IPR • RPM • Km • DIA²
	where:	
	Tool Power	= tool power (HP)
	IPR	= feed rate (in/rev)
	RPM	= revolutions per minute (rev/min)
	Km	= specific cutting energy (lbs/in ²)
	DIA	= diameter of drill (inch)

Material Constants

Type of Material	Hardness	Km (lbs/in ²)
Plain Carbon and Alloy Steel	85 - 200 BHN	0.79
	200 - 275 BHN	0.94
	275 - 375 BHN	1.00
High Temperature Alloys	-	1.44
Titanium Alloy	-	0.72
Stainless Steels	135 - 275 BHN	0.94
	30 - 45 RC	1.08
Cast Iron	100 - 200 BHN	0.50
	200 - 300 BHN	1.08
Copper Alloy	20 - 80 RB	0.43
	80 - 100 RB	0.72
Aluminum Alloy	-	0.22
Magnesium Alloy	-	0.16

Tap Drill Information and Formulas | Metric (mm)

Tap Size	Tap Drill Size	Decimal Equivalent (inch)	* Theo % Thread	Probable Mean Oversize	Probable Hole Size	** Probable % Thread
12 X 1.25	27/64	0.4219	79%	0.075 mm	10.79 mm	74%
	10.8 mm	0.4252	74%	0.075 mm	10.88 mm	69%
14 X 2.0	15/32	0.4688	81%	0.075 mm	11.98 mm	78%
	12.0 mm	0.4724	77%	0.075 mm	12.08 mm	74%
14 X 1.5	12.5 mm	0.4921	77%	0.075 mm	12.58 mm	73%
16 X 2.0	14.0 mm	0.5512	77%	0.075 mm	14.08 mm	74%
16 X 1.5	14.5 mm	0.5709	77%	0.075 mm	14.58 mm	73%
	37/64	0.5781	68%	0.075 mm	14.76 mm	64%
18 X 2.5	15.5 mm	0.6102	77%	0.075 mm	15.58 mm	75%
18 X 1.5	16.5 mm	0.6496	77%	0.075 mm	16.58 mm	73%
	21/32	0.6563	68%	0.075 mm	16.75 mm	64%
20 X 2.5	11/16	0.6875	78%	0.075 mm	17.54 mm	76%
	17.5 mm	0.6890	77%	0.075 mm	17.58 mm	74%
20 X 1.5	18.5 mm	0.7283	77%	0.075 mm	18.58 mm	73%
	47/64	0.7344	69%	0.075 mm	18.66 mm	65%
22 X 2.5	49/64	0.7656	79%	0.075 mm	19.52 mm	76%
	19.5 mm	0.7677	77%	0.075 mm	19.58 mm	75%
22 X 1.5	20.5 mm	0.8071	77%	0.075 mm	20.58 mm	73%
	13/16	0.8125	70%	0.075 mm	20.71 mm	66%
24 X 3	13/16	0.8125	86%	0.075 mm	20.71 mm	84%
	21.0 mm	0.8268	76%	0.075 mm	21.08 mm	75%
24 X 2	22.0 mm	0.8661	77%	0.075 mm	22.08 mm	74%
	7/8	0.8750	68%	0.075 mm	22.30 mm	65%
27 X 3	24.0 mm	0.9449	77%	0.075 mm	24.08 mm	75%

Formulas

1.	RPM	= (318.47 • M/min) / DIA
	where:	
	RPM	= revolutions per minute (rev/min)
	M/min	= speed (M/min)
	DIA	= diameter of drill (mm)
2.	mm/min	= RPM • mm/rev
	where:	
	mm/min	= mm per minute (mm/min)
	RPM	= revolutions per minute (rev/min)
	mm/rev	= feed rate (mm/rev)
3.	M/min	= RPM • 0.003 • DIA
	where:	
	M/min	= speed (M/min)
	RPM	= revolutions per minute (rev/min)
	DIA	= diameter of drill (mm)
4.	Thrust	= 154 • (mm/rev) • DIA • K_m
	where:	
	Thrust	= axial thrust (N)
	mm/rev	= feed rate (mm/rev)
	DIA	= diameter of drill (mm)
	K _m	= specific cutting energy (kPa)
5.	Tool Power	= ((mm/rev) • RPM • K_m • DIA²) / 218604.8
	where:	
	Tool Power	= tool power (HP)
	mm/rev	= feed rate (mm/rev)
	RPM	= revolutions per minute (rev/min)
	K _m	= specific cutting energy (kPa)
	DIA	= diameter of drill (mm)

BSP and ISO 7-1

Tap Size	Tap Drill Size	Decimal Equivalent	* Theo % Thread	Probable Mean Oversize	Probable Hole Size	** Probable % Thread
1/4-19	7/16"	0.4375"	-	0.075 mm	11.19 mm	-
3/8-19	37/64"	0.5781"	-	0.075 mm	14.76 mm	-
1/2-14	23/32"	0.7188"	-	0.075 mm	18.33 mm	-
3/4-14	15/16"	0.9375"	-	0.075 mm	23.89 mm	-

* Based on nominal tap drill diameter

** Based on 0.075mm probable mean oversize

To calculate the percent of full thread for a given hole diameter:

$$\% \text{ Thread} = \frac{76.93}{\text{Pitch (mm)}} \cdot (\text{Basic major diameter} - \text{Drill hole size})$$

Notes

- The above tap drill information represents probable thread percentages for the standard tap drills stocked at Allied Machine. Special insert diameters may be required in order to meet a user specific percentage of thread requirement.
- The .075mm probable mean oversize hole condition is based on optimum cutting conditions. Probable percent of full thread may vary based on less ideal cutting conditions.
- The table and equations on this page are found in the *Machinery's Handbook*. Permission to simplify and print the equations is granted by the Editor of the *Machinery's Handbook*.

Material Constants

Type of Material	Hardness	Km (kPa)
Plain Carbon and Alloy Steel	85 - 200 BHN	5.45
	200 - 275 BHN	6.48
	275 - 375 BHN	6.89
	375 - 425 BHN	7.93
High Temperature Alloys	-	9.93
Titanium Alloy	-	4.96
Stainless Steels	135 - 275 BHN	6.48
	30 - 45 RC	7.45
Cast Iron	100 - 200 BHN	3.45
	200 - 300 BHN	7.45
Copper Alloy	20 - 80 RB	2.96
	80 - 100 RB	4.96
Aluminum Alloy	-	1.52
Magnesium Alloy	-	1.10

Deep Hole Drilling Guidelines

GEN3SYS XT Pro | 10xD Holders

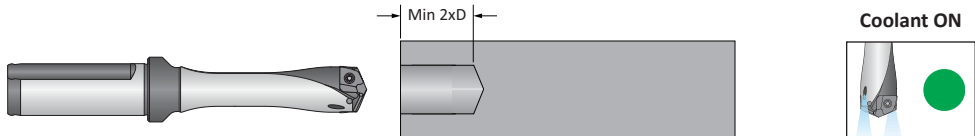
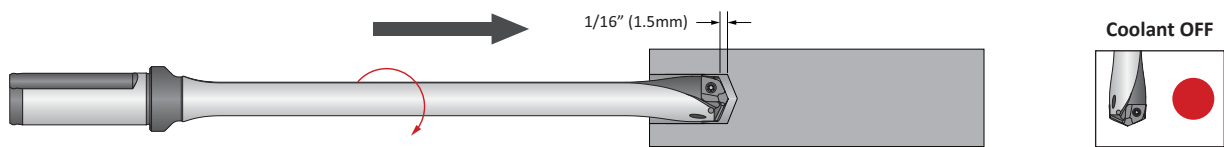
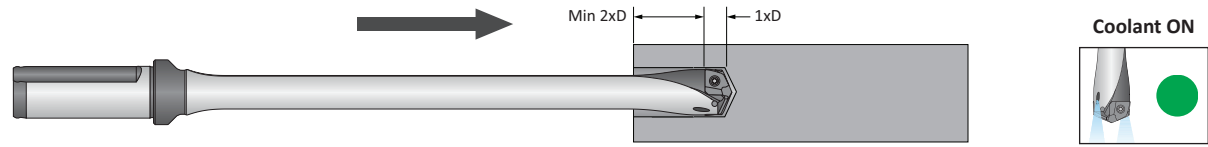
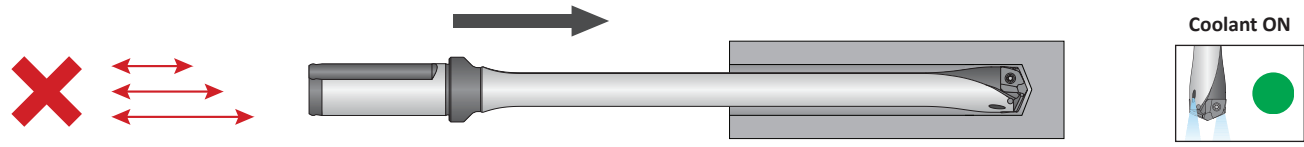
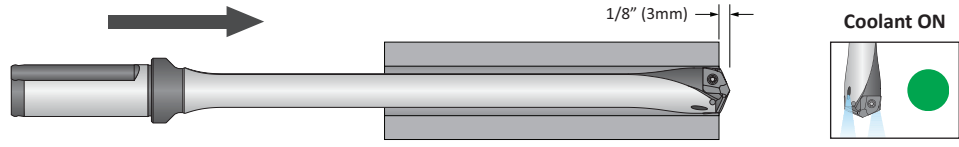
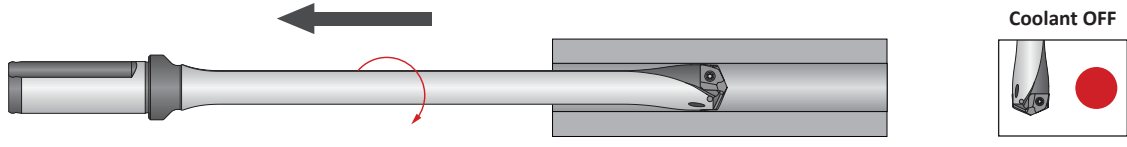
A DRILLING	<p>1. Pilot Hole 100 % RPM 100% IPR (mm/rev)</p>	<p>Establish the pilot hole using the same diameter short drill to a depth of 2xD minimum. Utilize a pilot drill with the same or larger included point angle.</p>	
B BORING	<p>2. Feed-in 50 RPM max 12 IPM (300 mm/min)</p>	<p>Feed the longer drill within 1/16" (1.5mm) short of the established pilot hole bottom at a maximum of 50 RPM and 12 IPM (300 mm/min) feed rate.</p>	
C REAMING	<p>3. Deep Hole Transition Drilling 50 % RPM 75% IPR (mm/rev)</p>	<p>Drill additional 1xD past the bottom of the pilot hole at 50% reduction of recommended speed and 25% reduction of recommended feed. Minimum of 1 second dwell is required to meet full speed before feeding.</p>	
D BURNISHING	<p>4. Deep Hole Drilling - Blind 100% RPM 100% IPR (mm/rev)</p>	<p>Drill to full depth at recommended speed and feed for longer drill according to Allied speed and feed charts. No peck cycle recommended.</p>	
E THREADING	<p>5. Deep Hole Drilling - at Breakout 50% RPM 75% IPR (mm/rev)</p>	<p>For through holes only: Reduce speed by 50% and feed by 25% prior to breakout. Do not breakout more than 1/8" (3mm) past the full diameter of the drill.</p>	
X SPECIALS	<p>6. Drill Retract 50 RPM max</p>	<p>Reduce speed to a maximum of 50 RPM before retracting from the hole.</p>	

1. WARNING Tool failure can cause serious injury. To prevent:

- When using holders without support bushing, use a short GEN3SYS holder to establish an initial hole that is a minimum of 2 diameters deep.
- Do not rotate tool holders more than 50 RPM unless it is engaged with the workpiece or fixture.

Visit www.alliedmachine.com/DeepHoleGuidelines for the most up-to-date information and procedures. Factory technical assistance is available for your specific applications through our Application Engineering Team.

Troubleshooting Guide

	Potential Problem																				Possible Solutions
	Accelerated corner wear	Barber pole	Bell mouth hole	Insert chipping	Blue chips	Build Up Edge (BUE)	Chatter	Chip packing	Chipping of point	Damaged or broken tools	Excessive margin wear	High flank wear	Hole lead off	Hole out of position	Hole out of round	Overize hole	Poor hole finish	Poor tool life	Power spikes - Load meter	Retract spiral	
Setup Condition	1	2	3	4	5	6	7	8	9	10	11	12	13	14	15	16	17	18	19	20	Possible Solutions
Worn or misaligned spindle (lathe, screw machine, chucker)	1		3				7		9	10	11		13			16	17			20	<ul style="list-style-type: none"> Align spindle and turret or tailstock. Repair spindle.
Use of low rigidity machine tools		2	3	4			7		9	10			13	14						20	<ul style="list-style-type: none"> Reduce penetration rate to fall within the physical limits of the machine or setup (NOTICE: Do not reduce feed below threshold of good chip formation).
Poor work piece support		2		4			7			10	11				15		17			20	<ul style="list-style-type: none"> Provide additional support for the work piece. Reduce penetration rate to fall within the physical limits of the machine or setup (NOTICE: Do not reduce feed below threshold of good chip formation).
Flood coolant, low coolant pressure, or low coolant volume	1				5	6		8		10		12				16	17	18	19		<ul style="list-style-type: none"> Run coolant through tool holder when drilling greater than 1xD. Increase coolant pressure and volume through the tool holder. Reduce penetration rate to fall within the coolant limitations (NOTICE: Do not reduce feed below threshold of good chip formation). Add a peck cycle to help clear chips.
Interrupted cuts. Entry or exit surfaces that are not perpendicular to the spindle (draft angles, parting lines, curved or stepped surfaces, cross holes, and cast or forged surfaces)				4			7		9	10	11		13	14	15	16	17	18			<ul style="list-style-type: none"> Pre-mill (spot face) entry or exit surface to remove interruption. Decrease feed as much as 50% through entry or exit interruption. Use short holders in low impact entry cuts.
Material harder than expected or running tools beyond recommended speed	1				5	6				10		12							18		<ul style="list-style-type: none"> Reduce speed. Increase coolant pressure and volume. Improve coolant condition by use of quality products and regular maintenance.
Poor material micro-structure or foreign particles (forgings and castings that have not been normalized or annealed, poorly prepared steel, flame cut parts, and sand casting)				4		6				10		12	13						18		<ul style="list-style-type: none"> Compare performance of other tools for similar wear problems, which may indicate poor micro-structure. Anneal or normalize parts to improve micro-structure for machining. Reduce feeds (NOTICE: Do not reduce feed below threshold of good chip formation).
Poor chip control								8		10	11		13			16	17	18	19		<ul style="list-style-type: none"> Increase feed to recommended levels. Contact Allied Application Engineering group for technical recommendations. Increase coolant pressure and volume. Improve coolant condition by use of quality products and regular maintenance.
Spot drilled holes with included angle less than that matching GEN3SYS XT or cored holes	1			4			7							13					18		<ul style="list-style-type: none"> Spot hole with short tool of same or greater included angle as GEN3SYS XT drill insert. Reduce feed (NOTICE: Do not reduce feed below threshold of good chip formation). If possible, drill from solid.

A

DRILLING

B

BORING

C

REAMING

D

BURNISHING

E

THREADING

X

SPECIALS

T-A[®] Drilling System

Replaceable Insert Drilling System | GEN2 T-A[®] | Original T-A[®]

► **Diameter Range:** 0.374" - 4.507" (9.50mm - 114.48mm)



This is Not Yesterday's Spade Drill

The T-A drilling system is an innovation inspired by the Universal replaceable spade insert drilling system. However, with the development of the GEN2 T-A insert, along with the countless geometry options for the Original T-A, this drilling system provides benefits and performance that spade blade inserts of the past never could.

With constant innovations in holder designs, insert geometries and coatings, and coolant dispersion, the T-A drilling system continues to evolve and become much more productive and powerful than ever before.

Excellent hole size and finish	Optimizes chip evacuation	Wide range of geometry options available
--------------------------------	---------------------------	--

Applicable Industries



Aerospace



Agriculture



Automotive



Firearms



General Machining



Oil & Gas



Renewable Energy

Your safety and the safety of others is very important. This catalog contains important safety messages. Always read and follow all safety precautions.



This triangle is a safety hazard symbol. It alerts you to potential safety hazards that can cause tool failure and serious injury.

When you see this symbol in the catalog, look for a related safety message that may be near this triangle or referred to in the nearby text.

There are safety signal words also used in the catalog. Safety messages follow these words.

WARNING

WARNING (shown above) means that failure to follow the precautions in this message could result in tool failure and serious injury.

NOTICE means that failure to follow the precautions in this message could result in damage to the tool or machine but not result in personal injury.

NOTE and **IMPORTANT** are also used. These are important that you read and follow but are not safety-related.

Visit www.alliedmachine.com for the most up-to-date information and procedures.

Reference Icons

The following icons will appear throughout the catalog to help you navigate between products.

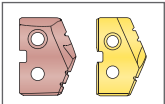

T-A Inserts

Refers to the range of inserts that connect with the corresponding holders

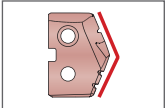

Available Insert Geometries

Details for the different geometry options available for each T-A insert style

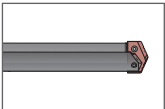

T-A Holders

Refers to the range of holders that connect with the corresponding inserts

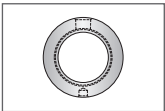

Rotary Coolant Adapter (RCA) Information

Detailed instructions and information regarding the corresponding part(s)



T-ACR Chamfer Rings

Refers to the range of T-ACR chamfer rings available for the corresponding holders



Technical Information

Detailed instructions and information regarding the corresponding part(s)

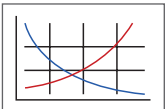

Recommended Cutting Data

Speed and feed recommendations for optimum and safe drilling

Series	Diameter Range	
	Imperial (inch)	Metric (mm)
Y	0.374 - 0.436	9.50 - 11.07
Z	0.437 - 0.510	11.10 - 12.95
0	0.511 - 0.695	12.98 - 17.65
1	0.690 - 0.960	17.53 - 24.38
2	0.961 - 1.380	24.41 - 35.05
3	1.353 - 1.882	34.36 - 47.80
4	1.850 - 2.570	46.99 - 65.28
5	2.456 - 3.000	62.38 - 76.20
6	3.001 - 3.507	76.22 - 89.08
7	3.508 - 4.000	89.10 - 101.60
8	4.001 - 4.507	101.63 - 114.48

Introduction Information

T-A Inserts Overview 2 - 3
 T-A Insert Geometries 4 - 6
 T-A Holders Overview 7
 Technical Information 8 - 9
 Product Nomenclature 10 - 11

T-A Drill Series

Y Series 12 - 21
 Z Series 22 - 31
 0 Series 32 - 43
 1 Series 44 - 57
 2 Series 58 - 73
 3 Series 74 - 85
 4 Series 86 - 93
 5 and 6 Series 94 - 101
 7 and 8 Series 102 - 109

T-A Drill Adapters

Rotary Coolant Adapters (RCA) 110
 T-ACR Chamfer Rings 111















Recommended Cutting Data

Imperial (inch)	GEN2 T-A 112 - 115
	Original T-A 116 - 119
	Flat Bottom Geometry 120 - 123
	Diamond Coating 124
	Tap Drill Information 125
	Coolant Recommendations 126 - 127
Metric (mm)	GEN2 T-A 128 - 131
	Original T-A 132 - 135
	Flat Bottom Geometry 136 - 139
	Diamond Coating 140
	Tap Drill Information 141
	Coolant Recommendations 142 - 143















Troubleshooting Guide 144 - 145

Deep Hole Drilling Guidelines 146



T-A Drilling System Overview | Drill Inserts







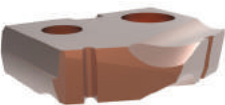
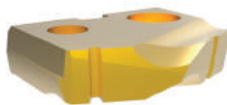

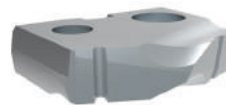
Series	Y Series	Z Series	0 Series	1 Series	2 Series	3 Series	4 Series
GEN2 T-A							
D ₁ inch	0.374 - 0.436	0.437 - 0.510	0.511 - 0.695	0.690 - 0.960	0.961 - 1.380	1.353 - 1.882	1.850 - 2.570
D ₁ mm	9.5 - 11.07	11.10 - 12.95	12.98 - 17.65	17.53 - 24.38	24.41 - 35.05	34.36 - 47.80	46.99 - 65.28
Half Series Option*							
HSS Substrates	Super Cobalt	Super Cobalt	Super Cobalt	Super Cobalt	Super Cobalt	HSS Super Cobalt Premium Cobalt	HSS Super Cobalt
Carbide Substrates	C1 (K35) C2 (K20)	C1 (K35) C2 (K20)	C1 (K35) C2 (K20)	C1 (K35) C2 (K20)	C1 (K35) C2 (K20)	-	-
Coatings	AM200®	AM200®	AM200®	AM200®	AM200®	AM200® TiN	AM200® TiN









*See page A30: 7 for more information regarding half series options

Series	Y Series	Z Series	0 Series	1 Series	2 Series	3 Series	4 Series
Original T-A							
D ₁ inch	0.374 - 0.436	0.437 - 0.510	0.511 - 0.695	0.690 - 0.960	0.961 - 1.380	1.353 - 1.882	1.850 - 2.570
D ₁ mm	9.5 - 11.07	11.10 - 12.95	12.98 - 17.65	17.53 - 24.38	24.41 - 35.05	34.36 - 47.80	46.99 - 65.28
Half Series Option*							
HSS Substrates	Super Cobalt Premium Cobalt	Super Cobalt Premium Cobalt	Super Cobalt Premium Cobalt	HSS Super Cobalt Premium Cobalt	HSS Super Cobalt Premium Cobalt	Super Cobalt	Super Cobalt
Carbide Substrates	C2 (K20) C3 (K10) C5 (P40) N2	C2 (K20) C3 (K10) C5 (P40) N2	C2 (K20) C3 (K10) C5 (P40) N2	C2 (K20) C3 (K10) C5 (P40) N2	C2 (K20) C3 (K10) C5 (P40) N2	C2 (K20) C5 (P40)	-
Coatings	TiN TiAlN TiCN	TiN TiAlN TiCN	TiN TiAlN TiCN	TiN TiAlN TiCN	TiN TiAlN TiCN	TiN	TiN

*See page A30: 7 for more information regarding half series options

Drill Insert Coatings			
 <p>AM200®</p> <ul style="list-style-type: none"> • First choice for increased heat resistance over TiN, TiCN, and TiAlN with improved wear capabilities • Allows for improved tool life and higher penetration rates • Over 20% increase in tool life compared to TiAlN coating • Color: copper/bronze 	 <p>TiN</p> <ul style="list-style-type: none"> • General purpose coating • Improved tool life over non-coated inserts • Excellent choice for aluminum • Color: gold/yellow 	 <p>TiAlN</p> <ul style="list-style-type: none"> • Excellent choice for wear resistance over high surface speeds • Excellent oxidation resistance • Maximum working temperature 800°C • Color: violet/gray 	 <p>TiCN</p> <ul style="list-style-type: none"> • Excellent choice for wear resistance over low surface speeds • High hardness/wear resistance • Maximum working temperature 400°C • Hardness HV 3500 • Color: blue/gray

5 Series	6 Series	7 Series	8 Series
			
2.456 - 3.000	3.001 - 3.507	3.508 - 4.000	4.001 - 4.507
62.38 - 76.20	76.22 - 89.08	89.10 - 101.60	101.63 - 114.48
			
HSS Super Cobalt	HSS Super Cobalt	HSS Super Cobalt	HSS Super Cobalt
-	-	-	-
AM200® TiN	AM200® TiN	AM200® TiN	AM200® TiN

5 Series	6 Series	7 Series	8 Series
			
2.456 - 3.000	3.001 - 3.507	3.508 - 4.000	4.001 - 4.507
62.38 - 76.20	76.22 - 89.08	89.10 - 101.60	101.63 - 114.48
			
HSS	HSS	HSS	HSS
-	-	-	-
TiN	TiN	TiN	TiN

Drill Insert Grades			
<p>HSS (Original / GEN2)</p> <p>First choice for general purpose use. Suited for difficult machining applications with low rigidity, as well as deep hole drilling. Recommended for drilling most steels, cast irons, and aluminum alloys up to 275 BHN 96kg.</p>	<p>HSS Super Cobalt (Original / GEN2)</p> <p>Suited for good-to-rigid machining applications, used for drilling exotic and high alloy materials, or general use when surface speed needs to be increased. For use in material hardness up to 350 BHN 121kg.</p>	<p>HSS Premium Cobalt (Original / GEN2)</p> <p>Suited for rigid machining applications, used for drilling exotic and high alloy materials, or general use when surface speed needs to be increased. For material hardness up to 400 BHN 139kg.</p>	<p>Carbide C5 (P40) (Original only)</p> <p>Excellent for drilling free machining steel, low/medium carbon steels, alloy steels, high strength steels, tool steels, and hardened steels.</p>
<p>Carbide C3 (K10) (Original only)</p> <p>Designed for drilling grey/white cast irons. The special geometry offers substantial increase in penetration rates and provides exceptional edge strength and tool life.</p>	<p>Carbide C2 (K20) (Original / GEN2)</p> <p>Excellent for drilling high temperature alloys, titanium alloys, cast aluminum, SG/Nodular cast iron, grey/white iron, aluminum bronze, brass, copper, and certain stainless steels.</p>	<p>Carbide C1 (K35) (GEN2 only)</p> <p>Excellent for drilling free machining steel, low/medium carbon steels, alloy steels, high strength steels, tool steels, and hardened steels.</p>	<p>Carbide N2 (Original only)</p> <p>Allied's N2 carbide is used with CVD diamond coating. This improves the insert's hardness, durability, and performance, which extends tool life between 30 - 50x over uncoated carbide.</p>

Insert Geometries

There's a Geometry for That

Allied Machine knows there isn't a one-size-fits-all solution when it comes to holemaking. To better accommodate the countless holes our customers drill, we have developed multiple geometry options, with new geometries in development at all times.

If you're unsure which geometry would be best for your application, give our Application Engineers a call. They're standing by, ready to point you in the right direction.

☎ 1.330.343.4283

☎ 1.800.321.5537 (toll free United States and Canada)

✉ appeng@alliedmachine.com

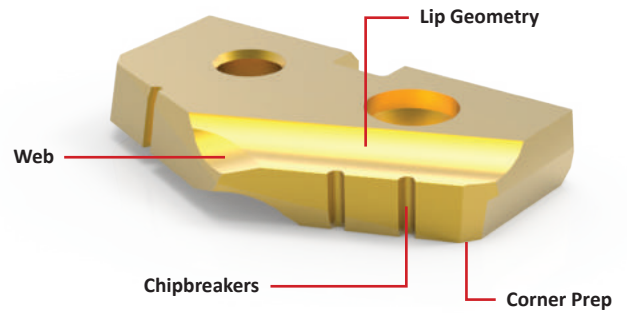

GEN2 T-A Drill Inserts

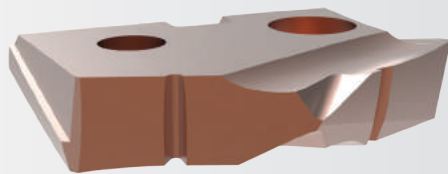

Original T-A Drill Inserts

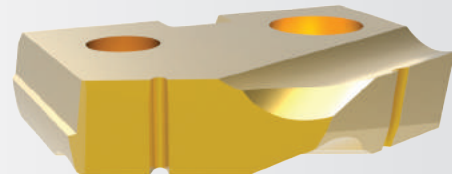

Standard

- Offers substantial increases in penetration rates and tool life
- Improves centering, drill stability, chip formation, and lowers drill forces
- Provides smoother break-out on through hole applications



Standard

- Offers excellent penetration rates and tool life
- Smooth break-out on through holes
- Increases drill stability and chip formation
- Ideally suited for low-to-high rigidity machining applications

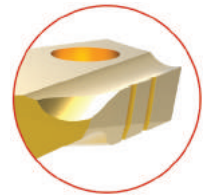

High Efficiency (-HE)

- Excellent chip formation in materials with very high elasticity/ductility and poor chip forming conditions
- Effective in lower powered machines
- Material example: low carbon steel (not suitable for stainless steel)



Tiny Chip (-TC)

- Unique lip and point design for excellent chip control
- Improves drilling capabilities in long-chipping materials
- Enhanced performance in lower-powered machines

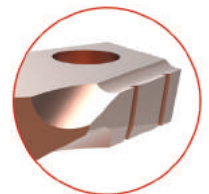

Corner Radius (-CR)

- Improves exit burrs
- Excellent surface finish in most applications
- Improves heat dispersion and tool life
- Can be used in addition to other geometries (as a special)

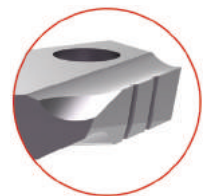

Special Corner Preparation (-SK)

- Ideal for machining cast iron materials
- Larger than a standard corner clip
- Improves heat resistance
- Standard feature on CI, HI, and HR geometries

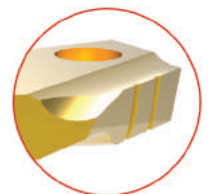

continued on next page

Cam Point (-CP)

- Helical cam ground point
- Improves drill stability and centering characteristics
- Reduces bell mouching when using longer holders
- Target materials: steels, cast/forged steels, cast iron

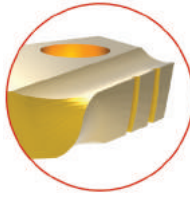

Notch Point® (-NP)

- Reduces bell mouth and lead-off
- Increases stability in deep hole applications
- Reduces thrust
- Can be used in addition to other geometries like Cast Iron, High Rake, and High Impact

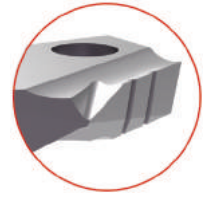

High Impact (-HI)

- Designed for materials with hardness > 200 BHN (700 N/mm²)
- Enhances chip formation in materials with high elasticity/ductility and poor chip forming characteristics
- SK corner clip improves tool life
- Target materials: structural/cast and forged steels (not suitable for stainless steel)



High Impact Notch Point® (-IN)

- Combination of High Impact and Notch Point geometries
- Increases stability in deep hole applications
- Enhances chip formation in materials with high elasticity/ductility and poor chip forming characteristics



High Rake (-HR)

- Designed for materials with hardness < 200 BHN (700 N/mm²)
- Improves chip formation in materials with very high elasticity/ductility, extremely poor chip forming characteristics, and low material hardness
- SK corner clip improves tool life
- Target materials: soft steels, steel castings and forgings (not suitable for stainless steel)

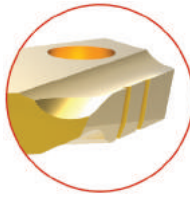

High Rake Notch Point® (-RN)

- Combination of High Rake and Notch Point geometries
- Reduces bell mouth and lead-off
- Improves chip formation in materials with very high elasticity/ductility, extremely poor chip forming characteristics, and low material hardness

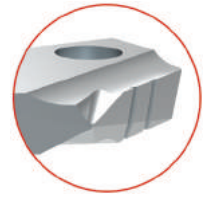

Cast Iron (-CI)

- Specifically designed for use in grey and white cast irons
- Exceptional edge strength
- SK2 corner preparation for improved tool life
- Standard geometry on C3 (K10) carbide inserts

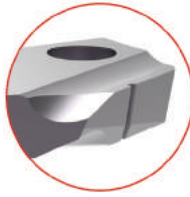

Cast Iron Notch Point® (-CN)

- Combination of Cast Iron and Notch Point geometries
- Increases stability in deep hole applications
- Specifically designed for use in grey and white cast irons

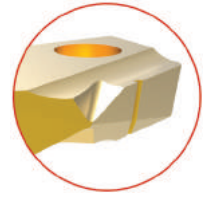

Aluminum (-AN)

- First choice for machining aluminum
- Enhanced geometry improves chip formation and hole quality
- TiN coating improves heat resistance and extends tool life

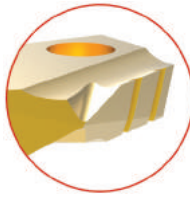

Brass (-BR)

- Improves tool life due to the specialized geometry and edge preparation
- Reduces self-feed tendency

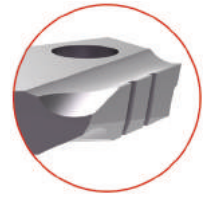

90° Spot and Chamfer (-SP)

- Center cutting web design improves stability and strength
- Eliminates the need for a secondary chamfering operation
- Available with chipbreakers (see -SW below)

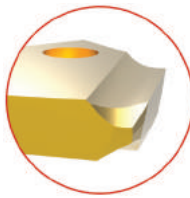

Flat Bottom (-FB)

- Ideal for flattening or squaring the bottom of pre-existing holes with high rigidity
- Includes small 10° point on the nose of the insert
- Available without chipbreakers (see -FN below)

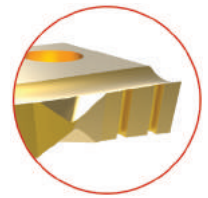

90° Spot and Chamfer (-SW)

- Center cutting web design improves stability and strength
- Eliminates the need for a secondary chamfering operation
- With added chipbreakers

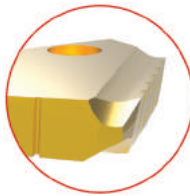

Flat Bottom (-FN)

- Ideal for flattening or squaring the bottom of pre-existing holes with high rigidity
- Includes small 10° point on the nose of the insert
- Available with chipbreakers (see -FB above)

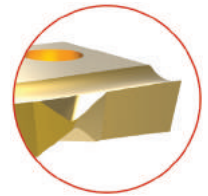



Available Standard Insert Geometries

The following table shows which geometries are available as a standard item (based on insert type and series). If you need a geometry on your insert, but it is not listed as available, please call the Application Engineering department to discuss quoting your insert as a special to include the desired geometry.

Additional lead time and process fees may apply.

Available Additional Geometries		GEN2 T-A			Original T-A					
		Y - 2 Series	3 - 4 Series	5 - 8 Series	HSS Inserts			Carbide Inserts		
					Y - 2 Series	3 - 4 Series	5 - 8 Series	Y - 2 Series	3 Series	
-AN	Aluminum				●				●	
-BR	Brass		●	●	●	●	●		●	●
-CI	Cast Iron		●		●	●			●	●
-CN	Notch Point® Cast Iron				●				●	●
-CP	Cam Point				●				●	
-CR	Corner Radius		●	●	●	●	●		●	●
-HE	High Elasticity	●	●							
-HI	High Impact		●	●	●	●	●		●	●
-HR	High Rake		●	●	●	●	●		●	●
-IN	Notch Point® High Impact				●				●	●
-NC	No Chipbreaker		●	●	●	●	●		●	●
-NP	Notch Point®				●				●	●
-RN	Notch Point® High Rake				●				●	●
-SK	Special Corner Preparation		●	●	●	●	●		●	●
-TC	Tiny Chip				●				●	
-WC	No Corner Clips		●	●	●	●	●		●	●

Drill Holders

Holder Length Options (for use with both GEN2 and Original T-A inserts)



Stub Length | Series: Y - 3 (straight flute flanged shank only)



Short Length | Series: ALL



Intermediate Length | Series: ALL



Standard Length | Series: ALL



Standard Plus Length | Series: Y - 2 (helical flute flanged shank only)



Extended Length | Series: 0 - 3



Long Length | Series: 0 - 2



Long Plus Length | Series: 0



XL Length | Series: ALL



3XL Length | Series: ALL

Holder Shank Options



ER Collet Shank
Series: Y, Z, 0



Straight Shank
Series: ALL



Morse Taper Shank
Series: ALL



Flanged Shank
Series: ALL

Half Series Holders (0.5, 1.5, 2.5)

Half series holders are recommended when running carbide inserts toward the upper end of the series drill range, as well as in tougher applications requiring more insert support and holder strength. **NOTE:** Only specified half series inserts should be used with half series holders.



Standard Series Insert +
Standard Series Holder

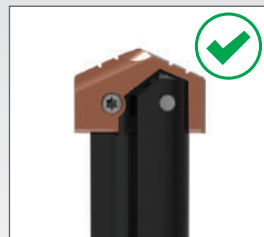

Half Series Insert +
Standard Series Holder



Half Series Insert +
Half Series Holder



Standard Series Insert +
Half Series Holder

⚠ WARNING Refer to Speed and Feed charts for recommended adjustments to speeds and feeds. Refer to page A30: 146 for deep hole drilling guidelines in this section of the catalog. Visit www.alliedmachine.com/DeepHoleGuidelines for the most up-to-date information and procedures. Factory technical assistance is available for your specific applications through our Application Engineering Team.

Technical Information

Next Level Solutions: GEN2 T-A

What takes a solution to the next level? When you make innovative designs and enhancements to a product that already achieves high performance results, you push the boundaries of what is known. And when you push the known boundaries, the unknown becomes the next level.

After all, everything begins as unknown.

AM200® Coating

- **Improves heat resistance** over TiN, TiCN, and TiAlN with improved wear capabilities
- **Increases penetration rates**
- **Increases tool life** more than 20% over TiAlN coating

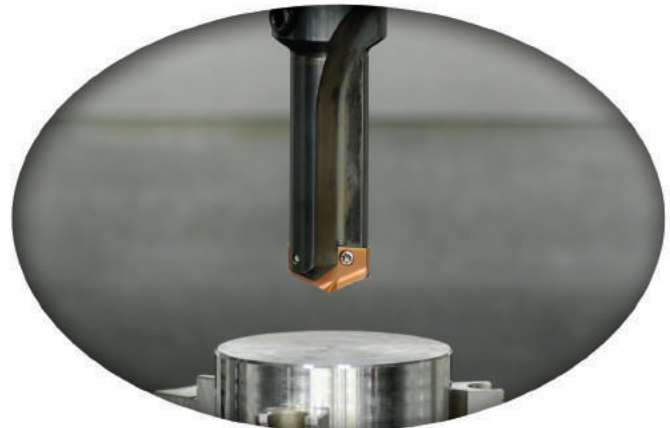
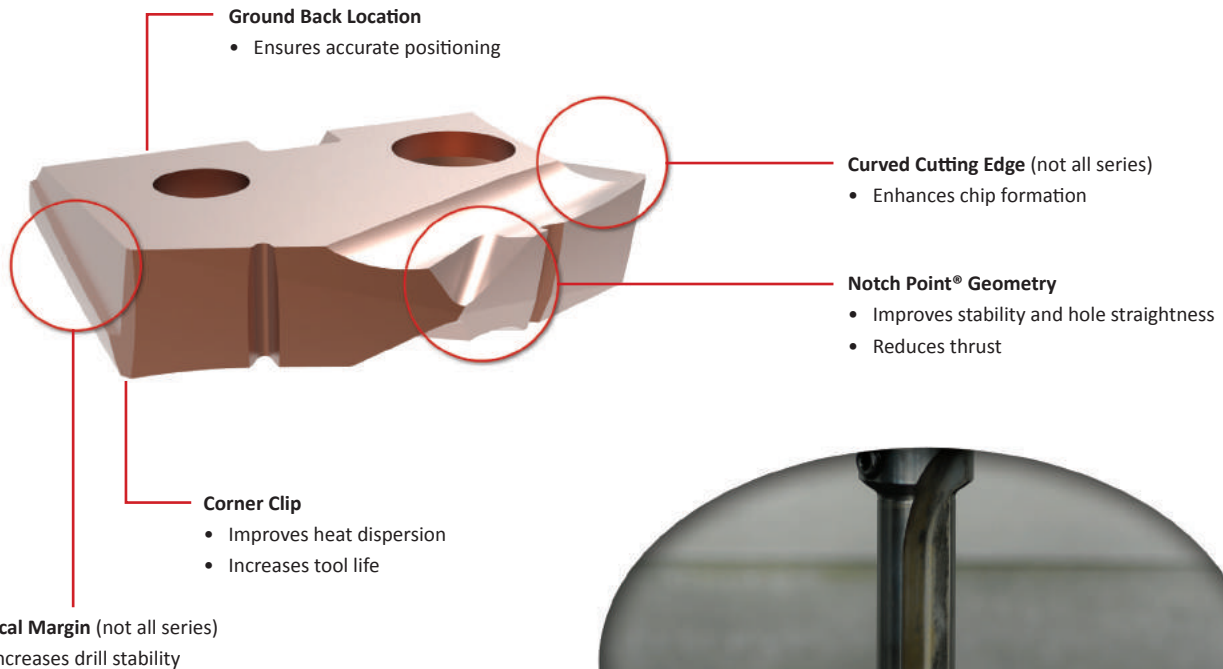

Improving Chip Formation

Achieving optimal chip formation is crucial. The quality of the chips being produced directly affects everything in the entire process: the cycle time, the tool life, the scrap rate, and the quality and condition of the final machined hole.

We know how important chip formation is. That's why we constantly improve and develop new geometries to create a better, more productive T-A product.

Setting Up New Applications

- Check coolant flows adequately through the tool before beginning
- Drill a short hole 1xD deep initially
- The chips produced should be short in length and material colored, not straw or blue
- Measure the hole produced to check that it is within the desired tolerance
- If all is correct, continue to machine the remainder of the hole
- Ensure the drilling process is quiet and smooth with no chip packing

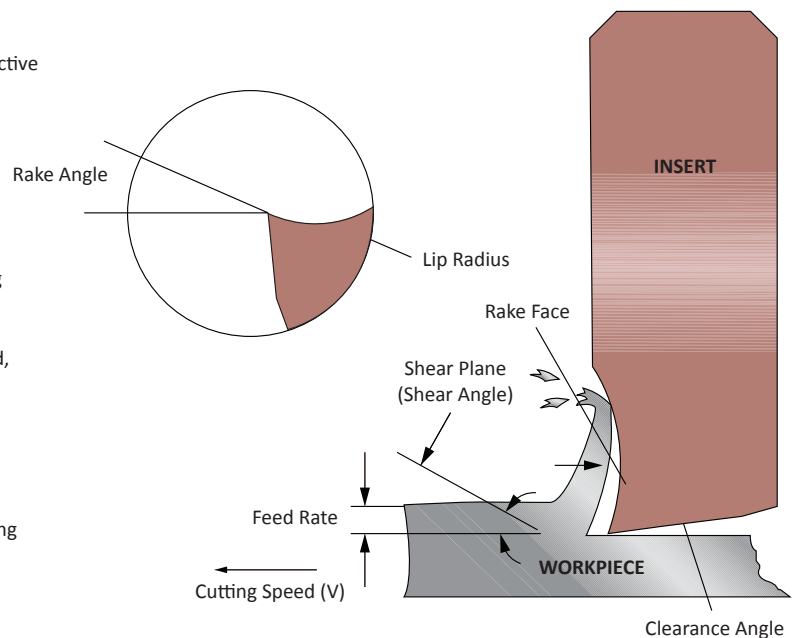

Wear vs Toughness

When selecting a grade of cutting tool material for your application, both wear resistance and grade toughness should be considered. The greater the wear resistance a cutting tool material exhibits, the more likely chipping or fracture is to occur. This requires more rigid machining conditions.

On the other hand, to effectively machine some materials, cobalt or carbide grades of cutting tool material may be required. The graph will aid you in the selection of a cutting tool material with the right combination of wear resistance and toughness to make your application both efficient and cost effective.

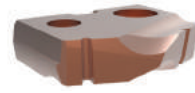

AM200°

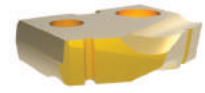

TiN



TiAlN

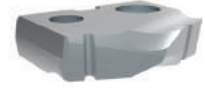

TiCN

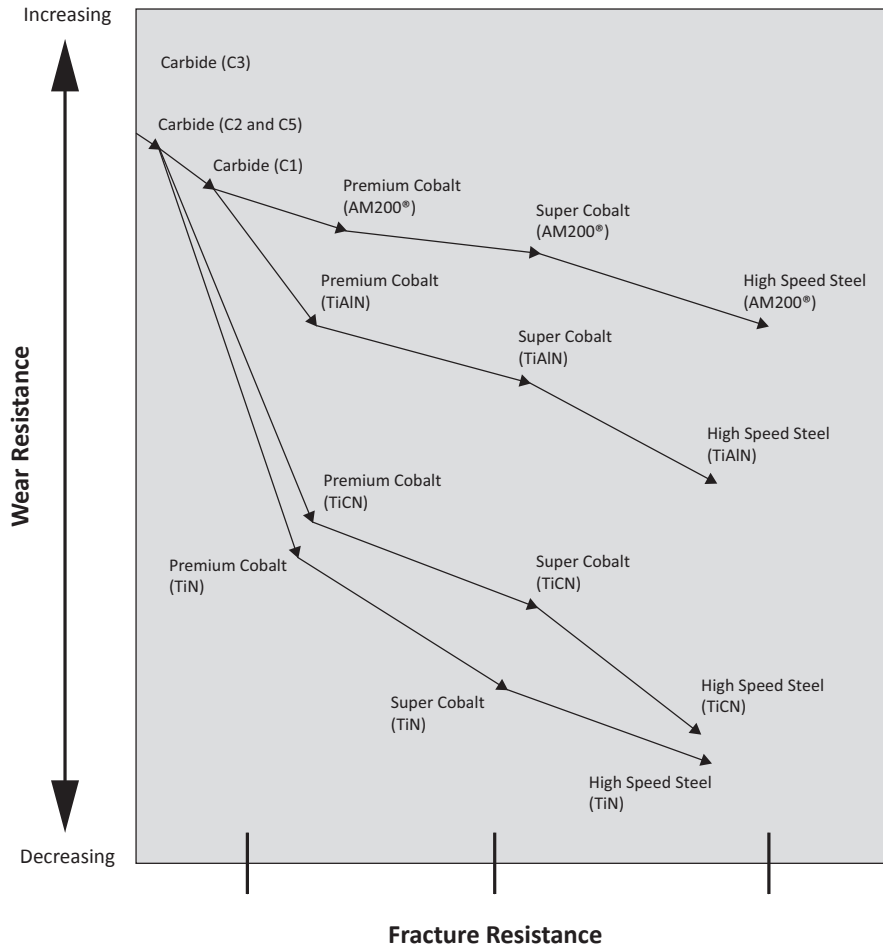

T-A System Guidelines for Use

- Select the shortest holder possible for the application
- Ensure the T-A holder is held securely and is within 0.003" (0.08mm) of center line
- The T-A insert should be installed in the slot of the holder using the TORX Plus screws provided. These should be tightened to the values listed on the T-A holder pages
- The holder slot should be clean from dirt or debris
- Check that the insert outer diameter is a minimum of 0.012" (0.30mm) larger than the holder body diameter
- Use the recommended cutting data section for guidance when selecting correct insert grades, along with speeds and feeds
- **NOTE:** These cutting parameters are starting conditions only and make no allowance for machine or component rigidity



Product Nomenclature

T-A Drill Inserts

4	5	3	H	-	0115
1	2	3	4		5

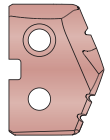

1. Insert	2. Material	3. Series	4. Coating	5. Diameter
<p>1 = Original T-A</p> <p>4 = GEN2 T-A</p>	<p>3 = HSS</p> <p>5 = Super cobalt</p> <p>8 = Premium cobalt</p> <p>C1 = C1 (K35) carbide</p> <p>C2 = C2 (K20) carbide</p> <p>C3 = C3 (K10) carbide</p> <p>C5 = C5 (P40) carbide</p>	<p>Y = Y series 4 = 4 series</p> <p>Z = Z series 5 = 5 series</p> <p>0 = 0 series 6 = 6 series</p> <p>1 = 1 series 7 = 7 series</p> <p>2 = 2 series 8 = 8 series</p> <p>3 = 3 series</p>	<p>H = AM200®</p> <p>A = TiAlN</p> <p>N = TiCN</p> <p>T = TiN</p>	<p>0017 = Inch</p> <p>.515 = Decimal</p> <p>13 = Metric</p>

Ordering Instructions

► Standard Items:

All orders are processed through Allied Machine's computerized order entry and invoicing system. Please specify the correct catalog number as well as a full description of the desired item(s) so we can process your order accurately and efficiently. Incorrect item numbers and/or descriptions will cause unnecessary delays and possible returns that are subject to a 10% restocking charge. Your assistance is critical if we are to achieve our goal of processing orders and shipping in-stock items error free within 24 hours.

► Non-Standard Sizes and Geometries:

Non-standard diameter	Substitute the required diameter in place of the standard diameter.
Ex: Standard item number	132T-0101
Non-standard diameter with standard geometry (inch)	132T-1.0200 (Note: 4 decimal places)
Non-standard diameter with standard geometry (metric)	132T-34.20 (Note: 2 decimal places)
Special geometry	Add the special geometry code at the end of the standard item number (see pages A30: 4 - 6 for geometry options).
Ex: Standard item number	132T-0101
Standard diameter with special geometry (inch)	132T-0101-SK
Non-standard diameter with special geometry	Replace the standard diameter and add the special geometry code.
Ex: Standard item number	132T-0101
Non-standard diameter with special geometry (inch)	132T-1.0200-SK (Note: 4 decimal places)

Reference Key

Symbol	Attribute
D_1	Insert diameter
T_1	Insert thickness

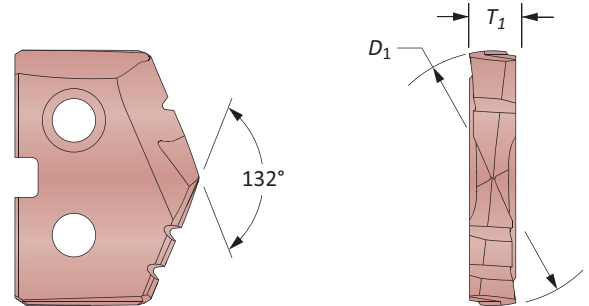

Product Nomenclature

T-A Drill Holders

2	30	20	S	-	004	I
1	2	3	4		5	6

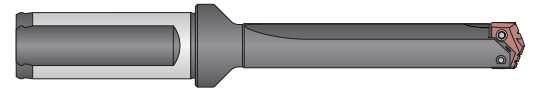

<p>1. Holder</p> <p>2 = T-A holder</p>	<p>2. Length</p> <p>10 = Stub 20 = Short 30 = Intermediate 40 = Standard 45 = Standard Plus 50 = Extended 60 = Long 65 = Long Plus 70 = XL 90 = 3XL</p>	<p>3. Series</p> <p>Y0 = Y series 20 = 2 series Z0 = Z series 25 = 2.5 series 00 = 0 series 30 = 3 series 05 = 0.5 series 40 = 4 series 10 = 1 series 50 = 5 series 15 = 1.5 series 70 = 7 series</p>	<p>4. Flute</p> <p>S = Straight H = Helical</p>																									
<p>5. Shank Designator</p> <table border="1"> <thead> <tr> <th>Morse Taper</th> <th>Imperial</th> <th>Metric</th> </tr> </thead> <tbody> <tr> <td>002 = 2MT</td> <td>063 = 5/8"</td> <td>16 = 16mm</td> </tr> <tr> <td>003 = 3MT</td> <td>075 = 3/4"</td> <td>20 = 20mm</td> </tr> <tr> <td>004 = 4MT</td> <td>100 = 1"</td> <td>25 = 25mm</td> </tr> <tr> <td>005 = 5MT</td> <td>125 = 1-1/4"</td> <td>32 = 32mm</td> </tr> <tr> <td></td> <td>150 = 1-1/2"</td> <td>40 = 40mm</td> </tr> <tr> <td></td> <td>175 = 1-3/4"</td> <td>50 = 50mm</td> </tr> <tr> <td></td> <td>200 = 2"</td> <td></td> </tr> <tr> <td></td> <td>300 = 3"</td> <td></td> </tr> </tbody> </table>	Morse Taper	Imperial	Metric	002 = 2MT	063 = 5/8"	16 = 16mm	003 = 3MT	075 = 3/4"	20 = 20mm	004 = 4MT	100 = 1"	25 = 25mm	005 = 5MT	125 = 1-1/4"	32 = 32mm		150 = 1-1/2"	40 = 40mm		175 = 1-3/4"	50 = 50mm		200 = 2"			300 = 3"		<p>6. Shank Code</p> <p>I = Imperial Morse taper M = Metric Morse taper L = Lathe shank F = Flanged shank FM = Flanged metric shank</p>
Morse Taper	Imperial	Metric																										
002 = 2MT	063 = 5/8"	16 = 16mm																										
003 = 3MT	075 = 3/4"	20 = 20mm																										
004 = 4MT	100 = 1"	25 = 25mm																										
005 = 5MT	125 = 1-1/4"	32 = 32mm																										
	150 = 1-1/2"	40 = 40mm																										
	175 = 1-3/4"	50 = 50mm																										
	200 = 2"																											
	300 = 3"																											

Reference Key

Symbol	Attribute
D_1	Drill insert range
D_2	Shank diameter
L_1	Overall length
L_2	Drill depth
L_3	Holder reference length
L_4	Holder length
L_7	Shank length
P_1	Rear pipe tap
P_2	Side pipe tap
RCA	Corresponding RCA item number
MT	Morse taper size
ER	ER collet size

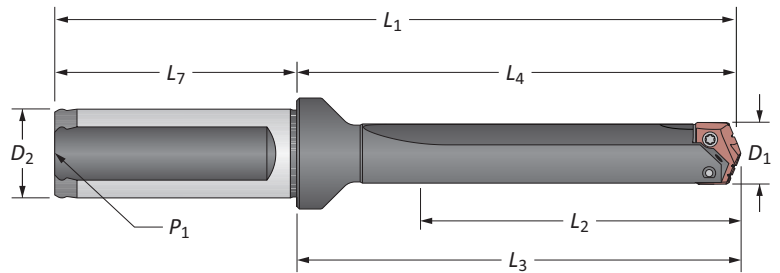

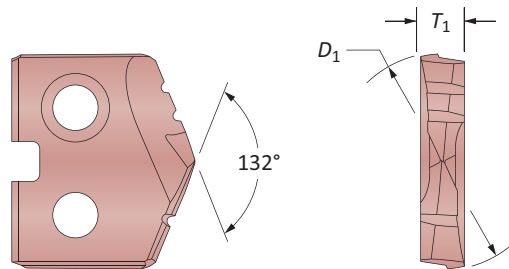
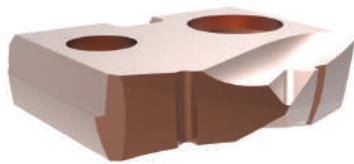

GEN2 T-A Drill Inserts

Y Series | Diameter Range: 0.374" - 0.436" (9.5mm - 11.07mm)



HSS Inserts – Super Cobalt • Carbide Inserts – C2 (K20) | C1 (K35)

Fractional Equivalent	Insert			HSS Part No.	Carbide Part No.	
	D_1 inch	D_1 mm	T_1	 Super Cobalt	 C2 (K20)	 C1 (K35)
–	0.3740	9.50	3/32	45YH-9.5	4C2YH-9.5	4C1YH-9.5
3/8	0.3750	9.53	3/32	45YH-0012	4C2YH-0012	4C1YH-0012
W	0.3860	9.80	3/32	45YH-.386	4C2YH-.386	4C1YH-.386
25/64	0.3906	9.92	3/32	45YH-.390	4C2YH-.390	4C1YH-.390
–	0.3937	10.00	3/32	45YH-10	4C2YH-10	4C1YH-10
–	0.4016	10.20	3/32	45YH-10.2	4C2YH-10.2	4C1YH-10.2
13/32	0.4063	10.32	3/32	45YH-0013	4C2YH-0013	4C1YH-0013
–	0.4134	10.50	3/32	45YH-10.5	4C2YH-10.5	4C1YH-10.5
27/64	0.4219	10.72	3/32	45YH-.421	4C2YH-.421	4C1YH-.421
–	0.4252	10.80	3/32	45YH-10.8	4C2YH-10.8	4C1YH-10.8
–	0.4331	11.00	3/32	45YH-11	4C2YH-11	4C1YH-11

A30: 112 - 143

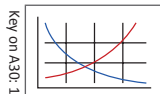

A30: 18 - 21

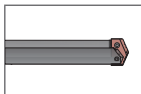

A30: 4 - 6



Coatings not listed above can be supplied as non-stocked standards. Process fees apply. →

TiN = 131T-XXXX

TiAlN = 131A-XXXX

TiCN = 131N-XXXX

AM200® = 131H-XXXX



Inserts sold in quantities of 2

Original T-A Drill Inserts

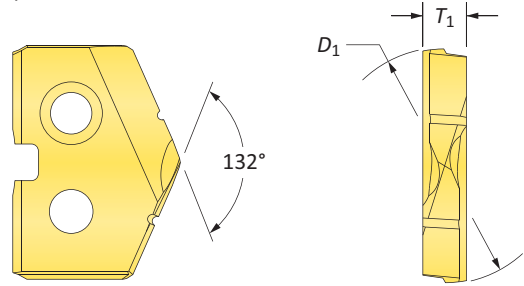
Y Series | HSS | Diameter Range: 0.374" - 0.436" (9.5mm - 11.07mm)



HSS Inserts – Premium Cobalt

Fractional Equivalent	Insert			Part No.		
	D_1 inch	D_1 mm	T_1	 TiN	 TiAlN	 TiCN
-	0.3740	9.50	3/32	18YT-9.5	18YA-9.5	18YN-9.5
3/8	0.3750	9.53	3/32	18YT-0012	18YA-0012	18YN-0012
W	0.3860	9.80	3/32	18YT-.386	18YA-.386	18YN-.386
25/64	0.3906	9.92	3/32	18YT-.390	18YA-.390	18YN-.390
-	0.3937	10.00	3/32	18YT-10	18YA-10	18YN-10
-	0.4016	10.20	3/32	18YT-10.2	18YA-10.2	18YN-10.2
13/32	0.4063	10.32	3/32	18YT-0013	18YA-0013	18YN-0013
-	0.4134	10.50	3/32	18YT-10.5	18YA-10.5	18YN-10.5
27/64	0.4219	10.72	3/32	18YT-.421	18YA-.421	18YN-.421
-	0.4252	10.80	3/32	18YT-10.8	18YA-10.8	18YN-10.8
-	0.4331	11.00	3/32	18YT-11	18YA-11	18YN-11

Key on A30-1

A30: 112 - 143

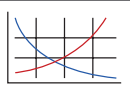

A30: 18 - 21



A30: 4 - 6

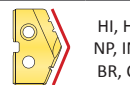

HI, HR, CR, TC, SK, NP, IN, RN, CN, AN, BR, CI, CP, NC, WC

Coatings not listed above can be supplied as non-stocked standards. Process fees apply. →

Inserts sold in quantities of 2



TiN = 131T-XXXX	TiAlN = 131A-XXXX
TiCN = 131N-XXXX	AM200® = 131H-XXXX

Original T-A Drill Inserts

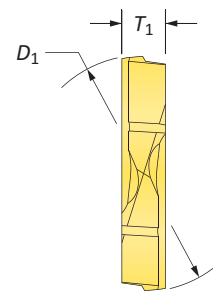
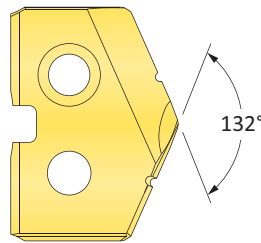
Y Series | HSS | Diameter Range: 0.374" - 0.436" (9.5mm - 11.07mm)



HSS Inserts – Super Cobalt

Fractional Equivalent	Insert			Part No.		
	D_1 inch	D_1 mm	T_1	 TiN	 TiAlN	 TiCN
–	0.3740	9.50	3/32	15YT-9.5	15YA-9.5	15YN-9.5
3/8	0.3750	9.53	3/32	15YT-0012	15YA-0012	15YN-0012
W	0.3860	9.80	3/32	15YT-.386	15YA-.386	15YN-.386
25/64	0.3906	9.92	3/32	15YT-.390	15YA-.390	15YN-.390
–	0.3937	10.00	3/32	15YT-10	15YA-10	15YN-10
–	0.4016	10.20	3/32	15YT-10.2	15YA-10.2	15YN-10.2
13/32	0.4063	10.32	3/32	15YT-0013	15YA-0013	15YN-0013
–	0.4134	10.50	3/32	15YT-10.5	15YA-10.5	15YN-10.5
27/64	0.4219	10.72	3/32	15YT-.421	15YA-.421	15YN-.421
–	0.4252	10.80	3/32	15YT-10.8	15YA-10.8	15YN-10.8
–	0.4331	11.00	3/32	15YT-11	15YA-11	15YN-11

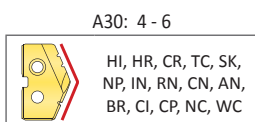
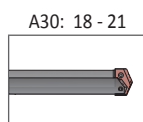
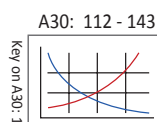

Coatings not listed above can be supplied as non-stocked standards. Process fees apply. →

TiN = 131T-XXXX	TiAlN = 131A-XXXX
TiCN = 131N-XXXX	AM200® = 131H-XXXX

Inserts sold in quantities of 2

Original T-A Drill Inserts

Y Series | HSS | Diameter Range: 0.374" - 0.436" (9.5mm - 11.07mm)

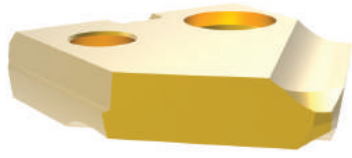



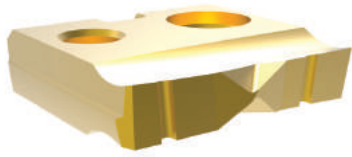
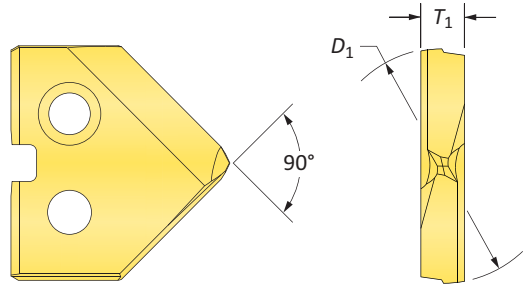

90° Spot & Chamfer

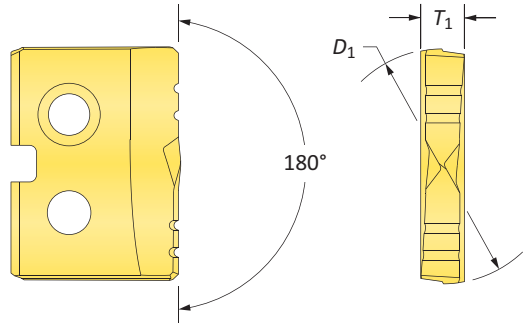

Flat Bottom



HSS Inserts – Super Cobalt

Fractional Equivalent	Insert			90° Spot & Chamfer Part No.			Flat Bottom Part No.
	D_1 inch	D_1 mm	T_1	 TiN	 TiAlN	 TiCN	 TiN
–	0.3740	9.50	3/32	15YT-9.5-SP	15YA-9.5-SP	15YN-9.5-SP	15YT-9.5-FB
3/8	0.3750	9.53	3/32	15YT-0012-SP	15YA-0012-SP	15YN-0012-SP	15YT-0012-FB
W	0.3860	9.80	3/32	15YT-.386-SP	15YA-.386-SP	15YN-.386-SP	15YT-.386-FB
25/64	0.3906	9.92	3/32	15YT-.390-SP	15YA-.390-SP	15YN-.390-SP	15YT-.390-FB
–	0.3937	10.00	3/32	15YT-10-SP	15YA-10-SP	15YN-10-SP	15YT-10-FB
–	0.4016	10.20	3/32	15YT-10.2-SP	15YA-10.2-SP	15YN-10.2-SP	15YT-10.2-FB
13/32	0.4063	10.32	3/32	15YT-0013-SP	15YA-0013-SP	15YN-0013-SP	15YT-0013-FB
–	0.4134	10.50	3/32	15YT-10.5-SP	15YA-10.5-SP	15YN-10.5-SP	15YT-10.5-FB
27/64	0.4219	10.72	3/32	15YT-.421-SP	15YA-.421-SP	15YN-.421-SP	15YT-.421-FB
–	0.4252	10.80	3/32	15YT-10.8-SP	15YA-10.8-SP	15YN-10.8-SP	15YT-10.8-FB
–	0.4331	11.00	3/32	15YT-11-SP	15YA-11-SP	15YN-11-SP	15YT-11-FB

A30: 112 - 143

A30: 18 - 21

A30: 4 - 6

A30: 4 - 6

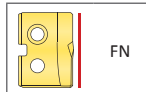
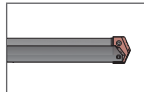
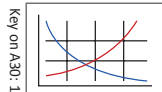

Inserts sold in quantities of 2

Coatings not listed above can be supplied as non-stocked standards. Process fees apply. →

TiN = 131T-XXXX	TiAlN = 131A-XXXX
TiCN = 131N-XXXX	AM200® = 131H-XXXX

Original T-A Drill Inserts

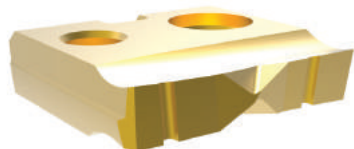
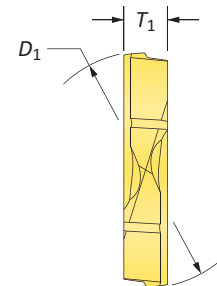
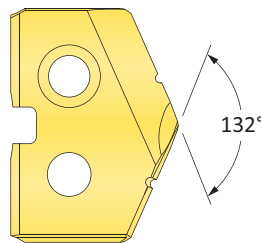

Y Series | Carbide | Diameter Range: 0.374" - 0.436" (9.5mm - 11.07mm)

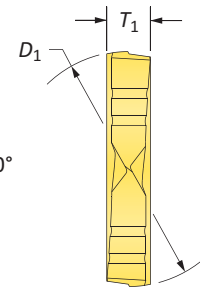
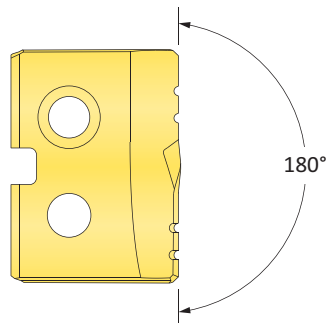

Flat Bottom



Carbide Inserts – C2 (K20)

Fractional Equivalent	Insert			Part No.		Flat Bottom Part No.
	D_1 inch	D_1 mm	T_1	 TiN	 TiAlN	 TiN
-	0.3740	9.50	3/32	1C2YT-9.5	1C2YA-9.5	1C2YT-9.5-FB
3/8	0.3750	9.53	3/32	1C2YT-0012	1C2YA-0012	1C2YT-0012-FB
W	0.3860	9.80	3/32	1C2YT-.386	1C2YA-.386	1C2YT-.386-FB
25/64	0.3906	9.92	3/32	1C2YT-.390	1C2YA-.390	1C2YT-.390-FB
-	0.3937	10.00	3/32	1C2YT-10	1C2YA-10	1C2YT-10-FB
-	0.4016	10.20	3/32	1C2YT-10.2	1C2YA-10.2	1C2YT-10.2-FB
13/32	0.4063	10.32	3/32	1C2YT-0013	1C2YA-0013	1C2YT-0013-FB
-	0.4134	10.50	3/32	1C2YT-10.5	1C2YA-10.5	1C2YT-10.5-FB
27/64	0.4219	10.72	3/32	1C2YT-.421	1C2YA-.421	1C2YT-.421-FB
-	0.4252	10.80	3/32	1C2YT-10.8	1C2YA-10.8	1C2YT-10.8-FB
-	0.4331	11.00	3/32	1C2YT-11	1C2YA-11	1C2YT-11-FB

Inserts sold in quantities of 2

A30: 112 - 143

A30: 18 - 21

A30: 4 - 6

A30: 4 - 6

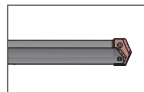
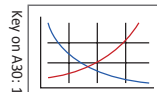

HI, HR, CR, TC, SK,
NP, IN, RN, CN, AN,
BR, CI, CP, NC, WC

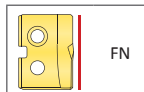

Coatings not listed above
can be supplied as
non-stocked standards.
Process fees apply. →



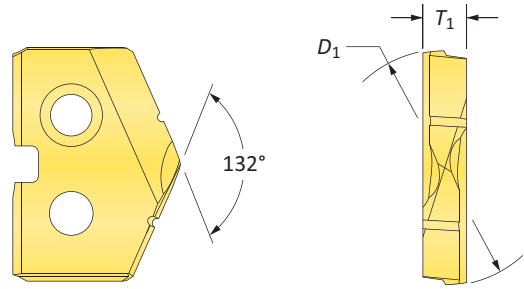

TiN = 131T-XXXX	TiAlN = 131A-XXXX
TiCN = 131N-XXXX	AM200® = 131H-XXXX

Original T-A Drill Inserts

Y Series | Carbide | Diameter Range: 0.374" - 0.436" (9.5mm - 11.07mm)



Carbide Inserts – C5 (P40) | C3 (K10) | N2

Fractional Equivalent	Insert			C5 Part No.		C3 Part No.	N2 Part No.
	D ₁ inch	D ₁ mm	T ₁	 TiN	 TiAlN	 TiAlN (Cast Iron)	 Diamond Film
-	0.3740	9.50	3/32	1C5YT-9.5	1C5YA-9.5	1C3YA-9.5-CI	1N2YD-9.5
3/8	0.3750	9.53	3/32	1C5YT-0012	1C5YA-0012	1C3YA-0012-CI	1N2YD-0012
W	0.3860	9.80	3/32	1C5YT-.386	1C5YA-.386	1C3YA-.386-CI	1N2YD-.386
25/64	0.3906	9.92	3/32	1C5YT-.390	1C5YA-.390	1C3YA-.390-CI	1N2YD-.390
-	0.3937	10.00	3/32	1C5YT-10	1C5YA-10	1C3YA-10-CI	1N2YD-10
-	0.4016	10.20	3/32	1C5YT-10.2	1C5YA-10.2	1C3YA-10.2-CI	1N2YD-10.2
13/32	0.4063	10.32	3/32	1C5YT-0013	1C5YA-0013	1C3YA-0013-CI	1N2YD-0013
-	0.4134	10.50	3/32	1C5YT-10.5	1C5YA-10.5	1C3YA-10.5-CI	1N2YD-10.5
27/64	0.4219	10.72	3/32	1C5YT-.421	1C5YA-.421	1C3YA-.421-CI	1N2YD-.421
-	0.4252	10.80	3/32	1C5YT-10.8	1C5YA-10.8	1C3YA-10.8-CI	1N2YD-10.8
-	0.4331	11.00	3/32	1C5YT-11	1C5YA-11	1C3YA-11-CI	1N2YD-11

A30: 112 - 143

Key on A30-1

A30: 18 - 21

A30: 4 - 6

HI, HR, CR, TC, SK, NP, IN, RN, CN, AN, BR, CI, CP, NC, WC

Coatings not listed above can be supplied as non-stocked standards. Process fees apply. →

Inserts sold in quantities of 2

TiN = 131T-XXXX	TiAlN = 131A-XXXX
TiCN = 131N-XXXX	AM200® = 131H-XXXX

T-A Drill Insert Holders

Y Series | Flange Shank

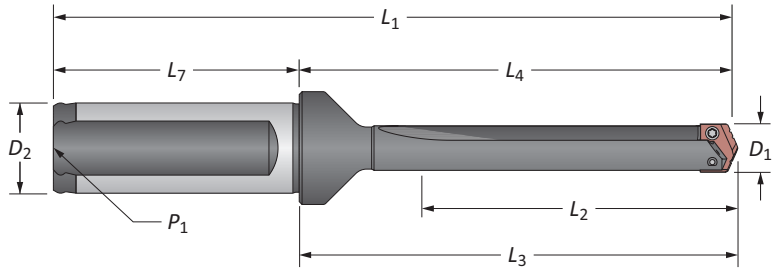

Stub Length

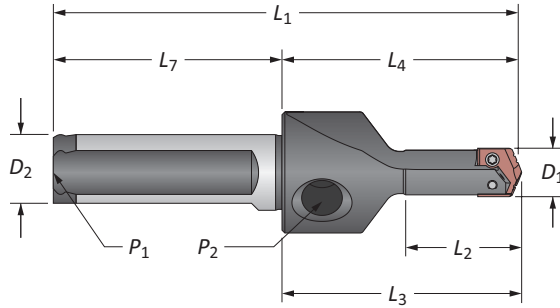

Straight Flute

	Length	Body					Shank			Part No.
		D_1	L_2	L_4	L_3	L_1	D_2	L_7	P_1	
i	Stub	3/8 - 27/64	3/4	1-7/8	1-31/32	3-3/4	5/8	1-7/8	1/16	210Y0S-063F
	Short	3/8 - 27/64	1-1/4	2-13/32	2-1/2	4-7/16	3/4	2-1/32	1/8	220Y0S-075F
	Standard	3/8 - 27/64	2-3/8	3-17/32	3-5/8	5-9/16	3/4	2-1/32	1/8	240Y0S-075F
	Extended	3/8 - 27/64	4-3/8	5-17/32	5-5/8	7-9/16	3/4	2-1/32	1/8	250Y0S-075F
m	Stub	9.5 - 11.0	19.1	47.6	50.0	95.6	16.0	48.0	1/16*	210Y0S-16FM
	Short	9.5 - 11.0	31.8	61.1	63.5	111.1	20.0	50.0	1/8*	220Y0S-20FM
	XL	9.5 - 11.0	222	251.7	254.1	301.7	20.0	50.0	1/8*	270Y0S-20FM
	3XL	9.5 - 11.0	290	319.9	322.3	369.9	20.0	50.0	1/8*	290Y0S-20FM

*Metric thread to BSP and ISO 7-1

NOTE: Stub length holders have a 1/8" side pipe tap (P_2)

Connection Accessories

Insert Screws	Nylon Locking Screws	Insert Driver	Preset Torque Hand Driver	Replacement Tips	Admissible Tightening Torque*
724-IP7-1	724N-IP7-1	8IP-7	8IP-7TL	8IP-7B	7.4 in-lbs (84 N-cm)

*Tightening torques are calculated with a friction coefficient of $\mu = 0.14$ and develop 90% of ultimate yield strength

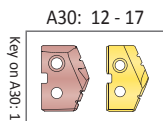

i = Imperial (in)
m = Metric (mm)

Screws sold in quantities of 10

WARNING Refer to Speed and Feed charts for recommended adjustments to speeds and feeds. Refer to page A30: 146 for deep hole drilling guidelines in this section of the catalog. Visit www.alliedmachine.com/DeepHoleGuidelines for the most up-to-date information and procedures. Factory technical assistance is available for your specific applications through our Application Engineering Team.



T-A Drill Insert Holders

Y Series | Flange Shank

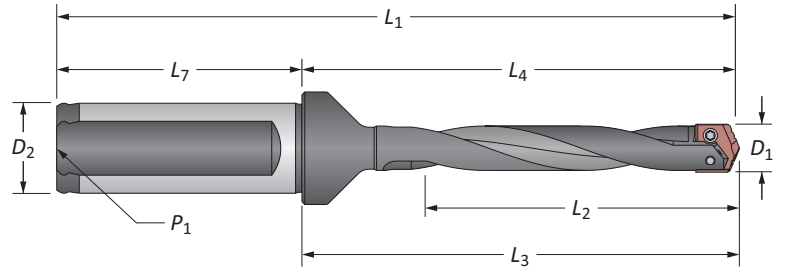

Helical Flute

Length	D ₁	Body				Shank			Part No.	
		L ₂	L ₄	L ₃	L ₁	D ₂	L ₇	P ₁		
i	Standard	3/8 - 27/64	2-3/8	3-17/32	3-5/8	5-9/16	3/4	2-1/32	1/8	240Y0H-075F
	Standard Plus	3/8 - 27/64	3-3/8	4-35/64	4-41/64	6-43/64	3/4	2-1/32	1/8	245Y0H-075F
	Extended	3/8 - 27/64	4-3/8	5-17/32	5-5/8	7-9/16	3/4	2-1/32	1/8	250Y0H-075F
m	Standard	9.5 - 11.0	60.3	89.7	92.1	139.7	20.0	50.0	1/8*	240Y0H-20FM
	Standard Plus	9.5 - 11.0	86.0	115.4	117.8	165.4	20.0	50.0	1/8*	245Y0H-20FM
	Extended	9.5 - 11.0	111.1	140.5	142.9	190.5	20.0	50.0	1/8*	250Y0H-20FM

*Metric thread to BSP and ISO 7-1

Connection Accessories

Insert Screws	Nylon Locking Screws	Insert Driver	Preset Torque Hand Driver	Replacement Tips	Admissible Tightening Torque*
724-IP7-1	724N-IP7-1	8IP-7	8IP-7TL	8IP-7B	7.4 in-lbs (84 N-cm)

*Tightening torques are calculated with a friction coefficient of $\mu = 0.14$ and develop 90% of ultimate yield strength

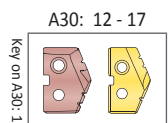

i = Imperial (in)
m = Metric (mm)

Screws sold in quantities of 10

WARNING Refer to Speed and Feed charts for recommended adjustments to speeds and feeds. Refer to page A30: 146 for deep hole drilling guidelines in this section of the catalog. Visit www.alliedmachine.com/DeepHoleGuidelines for the most up-to-date information and procedures. Factory technical assistance is available for your specific applications through our Application Engineering Team.

T-A Drill Insert Holders

Y Series | Taper Shank

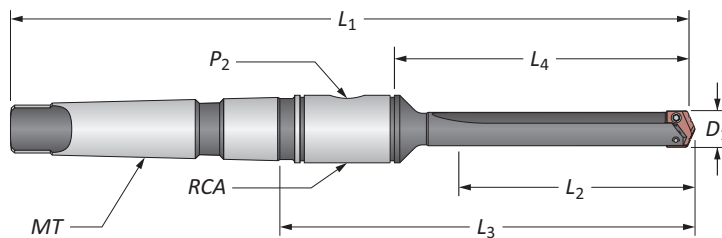

Straight Flute

	Length	D_1	Body				Shank			Part No.
			L_2	L_4	L_3	L_1	MT	P_2	RCA	
i	Short	3/8 - 27/64	1-1/4	2-1/32	3-15/32	6-5/16	#2	1/16	2T-2SR	220Y0S-002I
	Standard	3/8 - 27/64	2-3/8	3-5/32	4-19/32	7-7/16	#2	1/16	2T-2SR	240Y0S-002I
	Extended	3/8 - 27/64	4-3/8	5-5/32	6-19/32	9-7/16	#2	1/16	2T-2SR	250Y0S-002I
m	Short	9.5 - 11.0	31.8	51.5	88.0	160.3	#2**	1/16*	2T-2SRM	220Y0S-002M

*Metric thread to BSP and ISO 7-1

**Per ISO 296 type BEK

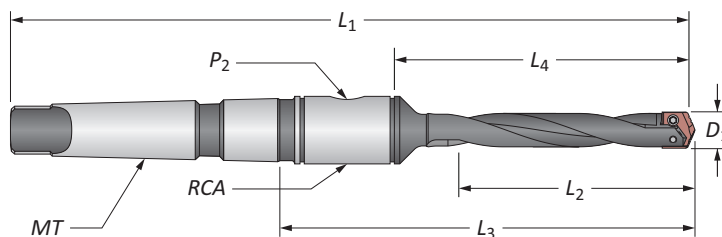

Helical Flute

	Length	D_1	Body				Shank			Part No.
			L_2	L_4	L_3	L_1	MT	P_2	RCA	
i	Standard	3/8 - 27/64	2-3/8	3-5/32	4-19/32	7-7/16	#2	1/16	2T-2SR	240Y0H-002I
	Extended	3/8 - 27/64	4-3/8	5-5/32	6-19/32	9-7/16	#2	1/16	2T-2SR	250Y0H-002I
m	Standard	9.5 - 11.0	60.3	80.2	116.7	188.9	#2**	1/16*	2T-2SRM	240Y0H-002M
	Extended	9.5 - 11.0	111.1	130.9	167.4	239.7	#2**	1/16*	2T-2SRM	250Y0H-002M

*Metric thread to BSP and ISO 7-1

**Per ISO 296 type BEK

Connection Accessories

Insert Screws	Nylon Locking Screws	Insert Driver	Preset Torque Hand Driver	Replacement Tips	Admissible Tightening Torque*
724-IP7-1	724N-IP7-1	8IP-7	8IP-7TL	8IP-7B	7.4 in-lbs (84 N-cm)

*Tightening torques are calculated with a friction coefficient of $\mu = 0.14$ and develop 90% of ultimate yield strength

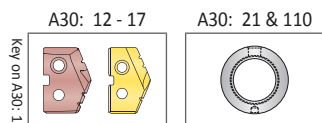

i = Imperial (in)

m = Metric (mm)

Screws sold in quantities of 10

WARNING Refer to Speed and Feed charts for recommended adjustments to speeds and feeds. Refer to page A30: 146 for deep hole drilling guidelines in this section of the catalog. Visit www.alliedmachine.com/DeepHoleGuidelines for the most up-to-date information and procedures. Factory technical assistance is available for your specific applications through our Application Engineering Team.

T-A Drill Insert Holders

Y Series | Straight Shank | ER Collet

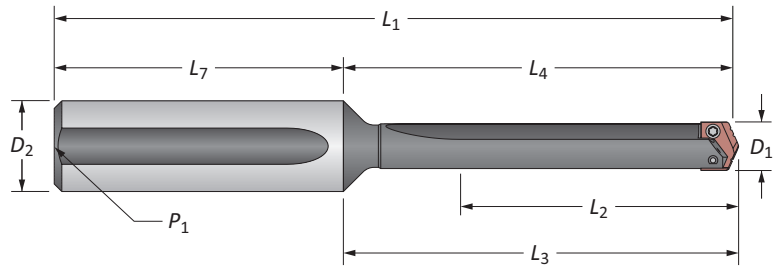

Straight Flute

Length	D ₁	Body				Shank			Part No.
		L ₂	L ₄	L ₃	L ₁	D ₂	L ₇	P ₁	
Short	3/8 - 27/64	1-1/4	2-1/32	2-1/8	4-13/32	3/4	2-3/8	1/8	220Y0S-075L
Standard	3/8 - 27/64	2-3/8	3-5/32	3-1/4	5-17/32	3/4	2-3/8	1/8	240Y0S-075L
Extended	3/8 - 27/64	4-3/8	5-5/32	5-1/4	7-17/32	3/4	2-3/8	1/8	250Y0S-075L
XL	3/8 - 27/64	8-3/4	9-17/32	9-5/8	11-29/32	3/4	2-3/8	1/8	270Y0S-075L
3XL	3/8 - 27/64	11-7/16	12-7/32	12-5/16	14-19/32	3/4	2-3/8	1/8	290Y0S-075L

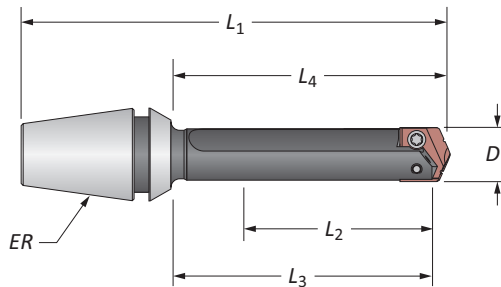

ER Collet Holder

D ₁	L ₂	Body			ER	Part No.	Collet Nut without Retaining Ring
		L ₄	L ₃	L ₁			
3/8 - 27/64	1-3/8	1-29/32	2	3-5/64	ER-16	210Y0S-16ER	ER-16N
3/8 - 27/64	1-3/8	1-29/32	2	3-15/64	ER-20	210Y0S-20ER	ER-20N

T-A Drill Accessories

Y Series | Rotary Coolant Adapters | Torx® Plus Screws

Rotary Coolant Adapter (RCA) and Accessories

ID	OD	L ₁	Driving Rod Thread	P ₁	Part No.	RCA O-Rings	
						Kit Part No.**	Replacements
3/4	1-3/4	7/8	5/16-18	1/8	2T-2SR	2T1-2SR	2T1-2OR-10
19.05	44.45	22.23	M8 x 1.25	1/8*	2T-2SRM	2T1-2SR	2T1-2OR-10

*Thread to BSP and ISO 7-1 | **RCA Repair Kit includes (2) O-rings, (2) snap rings, and (2) thrust washers

▲ Refer to page A30: 110 for proper RCA assembly and safety information

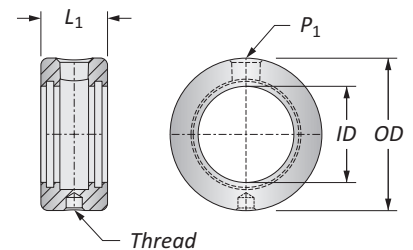

Connection Accessories

Insert Screws	Nylon Locking Screws	Insert Driver	Preset Torque Hand Driver	Replacement Tips	Admissible Tightening Torque*
724-IP7-1	724N-IP7-1	8IP-7	8IP-7TL	8IP-7B	7.4 in-lbs (84 N-cm)

*Tightening torques are calculated with a friction coefficient of $\mu = 0.14$ and develop 90% of ultimate yield strength

WARNING Refer to Speed and Feed charts for recommended adjustments to speeds and feeds. Refer to page A30: 146 for deep hole drilling guidelines in this section of the catalog. Visit www.alliedmachine.com/DeepHoleGuidelines for the most up-to-date information and procedures. Factory technical assistance is available for your specific applications through our Application Engineering Team.

ⓘ = Imperial (in)
 ⓘ = Metric (mm)
 Screws sold in packs of 10
 O-rings sold in packs of 10



Y
A DRILLING
B BORING
C REAMING
D BURNISHING
E THREADING
X SPECIALS

GEN2 T-A Drill Inserts

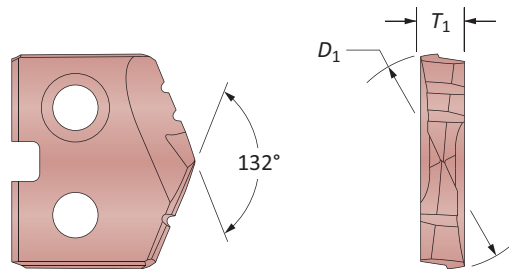
Z Series | Diameter Range: 0.437" - 0.510" (11.10mm - 12.95mm)



HSS Inserts – Super Cobalt • Carbide Inserts – C2 (K20) | C1 (K35)

Fractional Equivalent	Insert			HSS Part No.	Carbide Part No.	
	D_1 inch	D_1 mm	T_1	 Super Cobalt	 C2 (K20)	 C1 (K35)
7/16	0.4375	11.11	3/32	45ZH-0014	4C2ZH-0014	4C1ZH-0014
-	0.4510	11.46	3/32	45ZH-.451	4C2ZH-.451	4C1ZH-.451
-	0.4528	11.50	3/32	45ZH-11.5	4C2ZH-11.5	4C1ZH-11.5
29/64	0.4531	11.51	3/32	45ZH-.453	4C2ZH-.453	4C1ZH-.453
15/32	0.4688	11.91	3/32	45ZH-0015	4C2ZH-0015	4C1ZH-0015
-	0.4724	12.00	3/32	45ZH-12	4C2ZH-12	4C1ZH-12
31/64	0.4844	12.30	3/32	45ZH-.484	4C2ZH-.484	4C1ZH-.484
-	0.4921	12.50	3/32	45ZH-12.5	4C2ZH-12.5	4C1ZH-12.5
1/2	0.5000	12.70	3/32	45ZH-0016	4C2ZH-0016	4C1ZH-0016
-	0.5060	12.85	3/32	45ZH-.506	4C2ZH-.506	4C1ZH-.506
-	0.5100	12.95	3/32	45ZH-.510	4C2ZH-.510	4C1ZH-.510

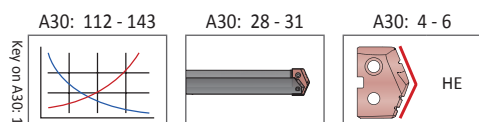

Coatings not listed above can be supplied as non-stocked standards. Process fees apply. →



Inserts sold in quantities of 2	
TiN = 131T-XXXX	TiAlN = 131A-XXXX
TiCN = 131N-XXXX	AM200® = 131H-XXXX

Original T-A Drill Inserts

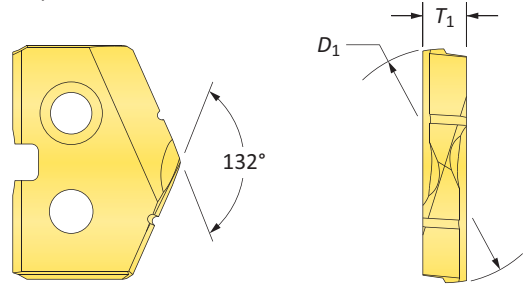
Z Series | HSS | Diameter Range: 0.437" - 0.510" (11.10mm - 12.95mm)



HSS Inserts – Premium Cobalt

Fractional Equivalent	Insert			Part No.		
	D_1 inch	D_1 mm	T_1	 TiN	 TiAlN	 TiCN
7/16	0.4375	11.11	3/32	18ZT-0014	18ZA-0014	18ZN-0014
-	0.4510	11.46	3/32	18ZT-.451	18ZA-.451	18ZN-.451
-	0.4528	11.50	3/32	18ZT-11.5	18ZA-11.5	18ZN-11.5
29/64	0.4531	11.51	3/32	18ZT-.453	18ZA-.453	18ZN-.453
15/32	0.4688	11.91	3/32	18ZT-0015	18ZA-0015	18ZN-0015
-	0.4724	12.00	3/32	18ZT-12	18ZA-12	18ZN-12
31/64	0.4844	12.30	3/32	18ZT-.484	18ZA-.484	18ZN-.484
-	0.4921	12.50	3/32	18ZT-12.5	18ZA-12.5	18ZN-12.5
1/2	0.5000	12.70	3/32	18ZT-0016	18ZA-0016	18ZN-0016
-	0.5060	12.85	3/32	18ZT-.506	18ZA-.506	18ZN-.506
-	0.5100	12.95	3/32	18ZT-.510	18ZA-.510	18ZN-.510

A30: 112 - 143

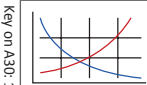

A30: 28 - 31



A30: 4 - 6



HI, HR, CR, TC, SK, NP, IN, RN, CN, AN, BR, CI, CP, NC, WC

Coatings not listed above can be supplied as non-stocked standards. Process fees apply. →

Inserts sold in quantities of 2



TiN = 131T-XXXX	TiAlN = 131A-XXXX
TiCN = 131N-XXXX	AM200® = 131H-XXXX

Original T-A Drill Inserts

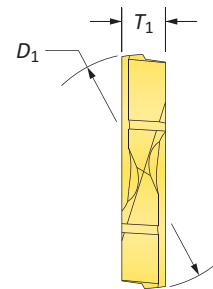
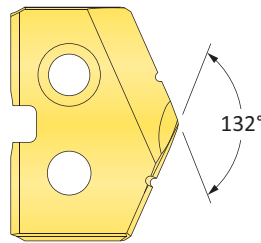
Z Series | HSS | Diameter Range: 0.437" - 0.510" (11.10mm - 12.95mm)



HSS Inserts – Super Cobalt

Fractional Equivalent	Insert			Part No.		
	D_1 inch	D_1 mm	T_1	 TiN	 TiAlN	 TiCN
7/16	0.4375	11.11	3/32	15ZT-0014	15ZA-0014	15ZN-0014
-	0.4510	11.46	3/32	15ZT-.451	15ZA-.451	15ZN-.451
-	0.4528	11.50	3/32	15ZT-11.5	15ZA-11.5	15ZN-11.5
29/64	0.4531	11.51	3/32	15ZT-.453	15ZA-.453	15ZN-.453
15/32	0.4688	11.91	3/32	15ZT-0015	15ZA-0015	15ZN-0015
-	0.4724	12.00	3/32	15ZT-12	15ZA-12	15ZN-12
31/64	0.4844	12.30	3/32	15ZT-.484	15ZA-.484	15ZN-.484
-	0.4921	12.50	3/32	15ZT-12.5	15ZA-12.5	15ZN-12.5
1/2	0.5000	12.70	3/32	15ZT-0016	15ZA-0016	15ZN-0016
-	0.5060	12.85	3/32	15ZT-.506	15ZA-.506	15ZN-.506
-	0.5100	12.95	3/32	15ZT-.510	15ZA-.510	15ZN-.510

A30: 112 - 143

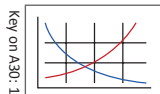

A30: 28 - 31

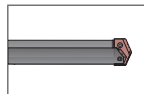

A30: 4 - 6

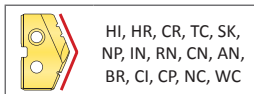

HI, HR, CR, TC, SK,
NP, IN, RN, CN, AN,
BR, CI, CP, NC, WC

Coatings not listed above
can be supplied as
non-stocked standards.
Process fees apply. →

TiN = 131T-XXXX

TiAlN = 131A-XXXX

TiCN = 131N-XXXX

AM200® = 131H-XXXX

Inserts sold in quantities of 2

Original T-A Drill Inserts

Z Series | HSS | Diameter Range: 0.437" - 0.510" (11.10mm - 12.95mm)

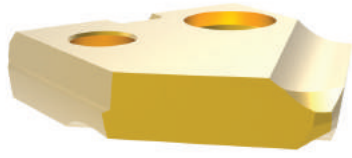



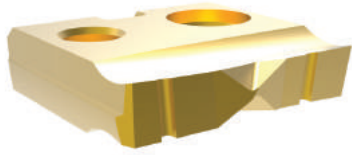
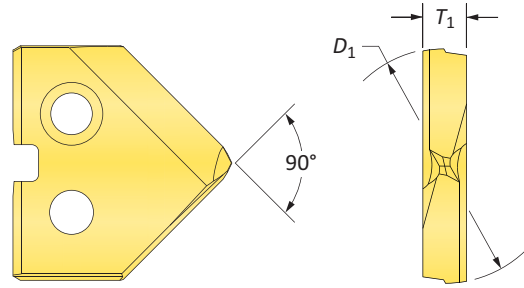

90° Spot & Chamfer

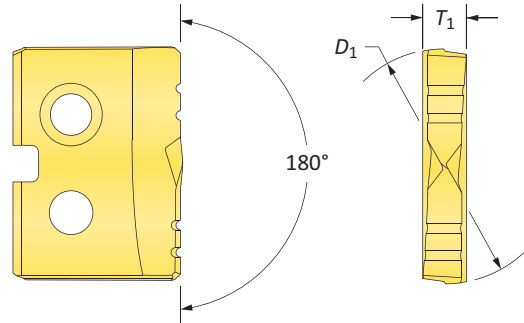

Flat Bottom



HSS Inserts – Super Cobalt

Fractional Equivalent	Insert			90° Spot & Chamfer Part No.			Flat Bottom Part No.
	D ₁ inch	D ₁ mm	T ₁	 TiN	 TiAlN	 TiCN	 TiN
7/16	0.4375	11.11	3/32	15ZT-0014-SP	15ZA-0014-SP	15ZN-0014-SP	15ZT-0014-FB
–	0.4510	11.46	3/32	15ZT-.451-SP	15ZA-.451-SP	15ZN-.451-SP	15ZT-.451-FB
–	0.4528	11.50	3/32	15ZT-11.5-SP	15ZA-11.5-SP	15ZN-11.5-SP	15ZT-11.5-FB
29/64	0.4531	11.51	3/32	15ZT-.453-SP	15ZA-.453-SP	15ZN-.453-SP	15ZT-.453-FB
15/32	0.4688	11.91	3/32	15ZT-0015-SP	15ZA-0015-SP	15ZN-0015-SP	15ZT-0015-FB
–	0.4724	12.00	3/32	15ZT-12-SP	15ZA-12-SP	15ZN-12-SP	15ZT-12-FB
31/64	0.4844	12.30	3/32	15ZT-.484-SP	15ZA-.484-SP	15ZN-.484-SP	15ZT-.484-FB
–	0.4921	12.50	3/32	15ZT-12.5-SP	15ZA-12.5-SP	15ZN-12.5-SP	15ZT-12.5-FB
1/2	0.5000	12.70	3/32	15ZT-0016-SP	15ZA-0016-SP	15ZN-0016-SP	15ZT-0016-FB
–	0.5060	12.85	3/32	15ZT-.506-SP	15ZA-.506-SP	15ZN-.506-SP	15ZT-.506-FB
–	0.5100	12.95	3/32	15ZT-.510-SP	15ZA-.510-SP	15ZN-.510-SP	15ZT-.510-FB

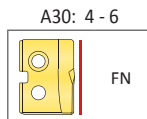
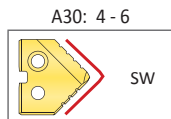
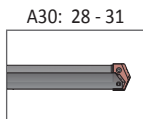
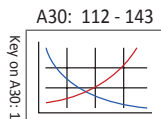

Inserts sold in quantities of 2

Coatings not listed above can be supplied as non-stocked standards. Process fees apply. →

TiN = 131T-XXXX	TiAlN = 131A-XXXX
TiCN = 131N-XXXX	AM200® = 131H-XXXX

Original T-A Drill Inserts

Z Series | Carbide | Diameter Range: 0.437" - 0.510" (11.10mm - 12.95mm)

A DRILLING

B BORING

C REAMING

D BURNISHING

F THREADING

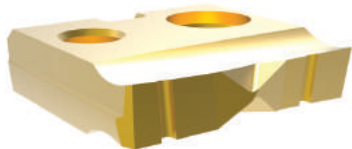
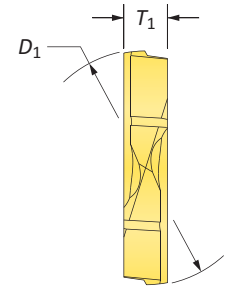
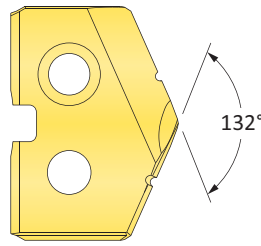

X SPECIALS

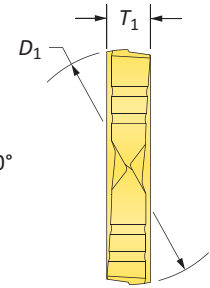
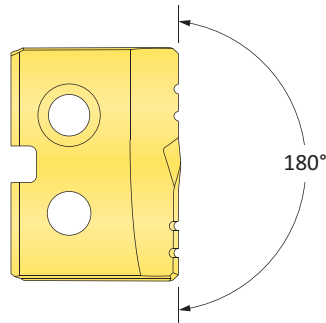

Flat Bottom



Carbide Inserts – C2 (K20)

Fractional Equivalent	Insert			Part No.		Flat Bottom Part No.
	D ₁ inch	D ₁ mm	T ₁	 TiN	 TiAlN	 TiN
7/16	0.4375	11.11	3/32	1C2ZT-0014	1C2ZA-0014	1C2ZT-0014-FB
-	0.4510	11.46	3/32	1C2ZT-.451	1C2ZA-.451	1C2ZT-.451-FB
-	0.4528	11.50	3/32	1C2ZT-11.5	1C2ZA-11.5	1C2ZT-11.5-FB
29/64	0.4531	11.51	3/32	1C2ZT-.453	1C2ZA-.453	1C2ZT-.453-FB
15/32	0.4688	11.91	3/32	1C2ZT-0015	1C2ZA-0015	1C2ZT-0015-FB
-	0.4724	12.00	3/32	1C2ZT-12	1C2ZA-12	1C2ZT-12-FB
31/64	0.4844	12.30	3/32	1C2ZT-.484	1C2ZA-.484	1C2ZT-.484-FB
-	0.4921	12.50	3/32	1C2ZT-12.5	1C2ZA-12.5	1C2ZT-12.5-FB
1/2	0.5000	12.70	3/32	1C2ZT-0016	1C2ZA-0016	1C2ZT-0016-FB
-	0.5060	12.85	3/32	1C2ZT-.506	1C2ZA-.506	1C2ZT-.506-FB
-	0.5100	12.95	3/32	1C2ZT-.510	1C2ZA-.510	1C2ZT-.510-FB

Inserts sold in quantities of 2

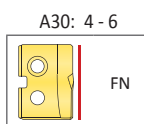
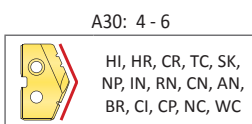
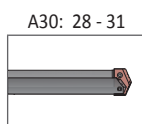
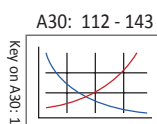

Coatings not listed above can be supplied as non-stocked standards. Process fees apply. →



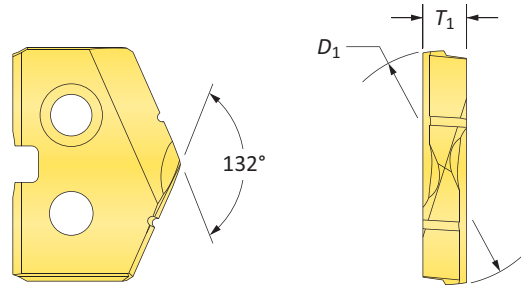

TiN = 131T-XXXX	TiAlN = 131A-XXXX
TiCN = 131N-XXXX	AM200® = 131H-XXXX

Original T-A Drill Inserts

Z Series | Carbide | Diameter Range: 0.437" - 0.510" (11.10mm - 12.95mm)



Carbide Inserts – C5 (P40) | C3 (K10) | N2

Fractional Equivalent	Insert			C5 Part No.		C3 Part No.	N2 Part No.
	D ₁ inch	D ₁ mm	T ₁	 TiN	 TiAlN	 TiAlN (Cast Iron)	 Diamond Film
7/16	0.4375	11.11	3/32	1C5ZT-0014	1C5ZA-0014	1C3ZA-0014-CI	1N2ZD-0014
-	0.4510	11.46	3/32	1C5ZT-.451	1C5ZA-.451	1C3ZA-.451-CI	1N2ZD-.451
-	0.4528	11.50	3/32	1C5ZT-11.5	1C5ZA-11.5	1C3ZA-11.5-CI	1N2ZD-11.5
29/64	0.4531	11.51	3/32	1C5ZT-.453	1C5ZA-.453	1C3ZA-.453-CI	1N2ZD-.453
15/32	0.4688	11.91	3/32	1C5ZT-0015	1C5ZA-0015	1C3ZA-0015-CI	1N2ZD-0015
-	0.4724	12.00	3/32	1C5ZT-12	1C5ZA-12	1C3ZA-12-CI	1N2ZD-12
31/64	0.4844	12.30	3/32	1C5ZT-.484	1C5ZA-.484	1C3ZA-.484-CI	1N2ZD-.484
-	0.4921	12.50	3/32	1C5ZT-12.5	1C5ZA-12.5	1C3ZA-12.5-CI	1N2ZD-12.5
1/2	0.5000	12.70	3/32	1C5ZT-0016	1C5ZA-0016	1C3ZA-0016-CI	1N2ZD-0016
-	0.5060	12.85	3/32	1C5ZT-.506	1C5ZA-.506	1C3ZA-.506-CI	1N2ZD-.506
-	0.5100	12.95	3/32	1C5ZT-.510	1C5ZA-.510	1C3ZA-.510-CI	1N2ZD-.510

A30: 112 - 143

Key on A30-1

A30: 28 - 31

A30: 4 - 6

HI, HR, CR, TC, SK, NP, IN, RN, CN, AN, BR, CI, CP, NC, WC

Coatings not listed above can be supplied as non-stocked standards. Process fees apply. →

Inserts sold in quantities of 2

TiN = 131T-XXXX	TiAlN = 131A-XXXX
TiCN = 131N-XXXX	AM200® = 131H-XXXX

T-A Drill Insert Holders

Z Series | Flange Shank

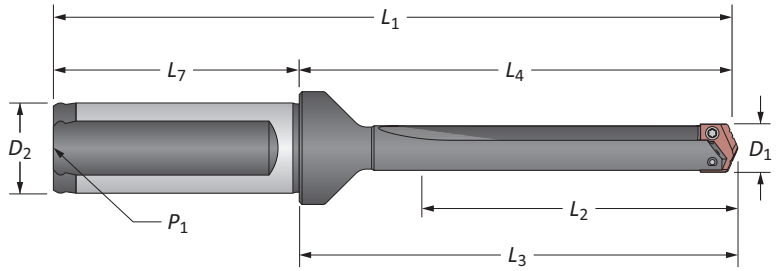

Stub Length

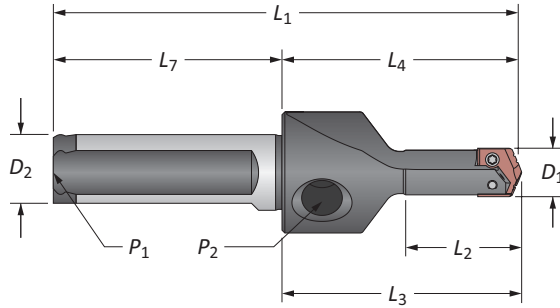

Straight Flute

Length	D ₁	Body				Shank			Part No.
		L ₂	L ₄	L ₃	L ₁	D ₂	L ₇	P ₁	
Stub	7/16 - 1/2	3/4	1-7/8	1-31/32	3-3/4	5/8	1-7/8	1/16	210Z0S-063F
Short	7/16 - 1/2	1-1/4	2-13/32	2-1/2	4-7/16	3/4	2-1/32	1/8	220Z0S-075F
Standard	7/16 - 1/2	2-3/8	3-17/32	3-5/8	5-9/16	3/4	2-1/32	1/8	240Z0S-075F
Extended	7/16 - 1/2	4-3/8	5-17/32	5-5/8	7-9/16	3/4	2-1/32	1/8	250Z0S-075F
Stub	11.5 - 12.5	19.1	47.6	50.0	95.6	16.0	48.0	1/16*	210Z0S-16FM
Short	11.5 - 12.5	31.8	61.1	63.5	111.1	20.0	50.0	1/8*	220Z0S-20FM
XL	11.5 - 12.5	222.3	251.7	254.1	301.7	20.0	50.0	1/8*	270Z0S-20FM
3XL	11.5 - 12.5	290.5	319.9	322.3	369.9	20.0	50.0	1/8*	290Z0S-20FM

*Metric thread to BSP and ISO 7-1

NOTE: Stub length holders have a 1/8" side pipe tap (P₂)

Connection Accessories

Insert Screws	Nylon Locking Screws	Insert Driver	Preset Torque Hand Driver	Replacement Tips	Admissible Tightening Torque*
7247-IP7-1	7247N-IP7-1	8IP-7	8IP-7TL	8IP-7B	7.4 in-lbs (84 N-cm)

*Tightening torques are calculated with a friction coefficient of $\mu = 0.14$ and develop 90% of ultimate yield strength

A30: 22 - 27

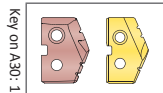

i = Imperial (in)
m = Metric (mm)

Screws sold in quantities of 10

WARNING Refer to Speed and Feed charts for recommended adjustments to speeds and feeds. Refer to page A30: 146 for deep hole drilling guidelines in this section of the catalog. Visit www.alliedmachine.com/DeepHoleGuidelines for the most up-to-date information and procedures. Factory technical assistance is available for your specific applications through our Application Engineering Team.



T-A Drill Insert Holders

Z Series | Flange Shank

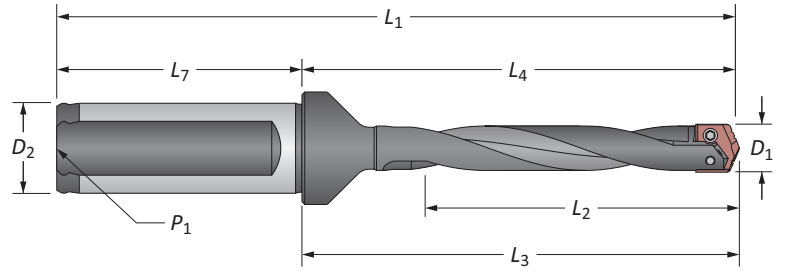

Helical Flute

	Length	D ₁	Body				Shank			Part No.
			L ₂	L ₄	L ₃	L ₁	D ₂	L ₇	P ₁	
i	Standard	7/16 - 1/2	2-3/8	3-17/32	3-5/8	5-9/16	3/4	2-1/32	1/8	240Z0H-075F
	Standard Plus	7/16 - 1/2	3-3/8	4-35/64	4-41/64	6-43/64	3/4	2-1/32	1/8	245Z0H-075F
	Extended	7/16 - 1/2	4-3/8	5-17/32	5-5/8	7-9/16	3/4	2-1/32	1/8	⚠ 250Z0H-075F
	Long	7/16 - 1/2	7-1/16	8-1/4	8-11/32	10-3/8	3/4	2-1/32	1/8	⚠ 260Z0H-075F
m	Standard	11.5 - 12.5	60.3	89.7	92.1	139.7	20.0	50.0	1/8*	240Z0H-20FM
	Standard Plus	11.5 - 12.8	86.0	115.4	117.8	165.4	20.0	50.0	1/8*	245Z0H-20FM
	Extended	11.5 - 12.5	111.1	140.5	142.9	190.5	20.0	50.0	1/8*	⚠ 250Z0H-20FM
	Long	11.5 - 12.8	180.0	209.4	211.8	259.4	20.0	50.0	1/8*	⚠ 260Z0H-20FM

*Metric thread to BSP and ISO 7-1

Connection Accessories

Insert Screws	Nylon Locking Screws	Insert Driver	Preset Torque Hand Driver	Replacement Tips	Admissible Tightening Torque*
7247-IP7-1	7247N-IP7-1	8IP-7	8IP-7TL	8IP-7B	7.4 in-lbs (84 N-cm)

*Tightening torques are calculated with a friction coefficient of $\mu = 0.14$ and develop 90% of ultimate yield strength

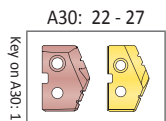

i = Imperial (in)
m = Metric (mm)

Screws sold in quantities of 10

⚠ WARNING Refer to Speed and Feed charts for recommended adjustments to speeds and feeds. Refer to page A30: 146 for deep hole drilling guidelines in this section of the catalog. Visit www.alliedmachine.com/DeepHoleGuidelines for the most up-to-date information and procedures. Factory technical assistance is available for your specific applications through our Application Engineering Team.

T-A Drill Insert Holders

Z Series | Taper Shank

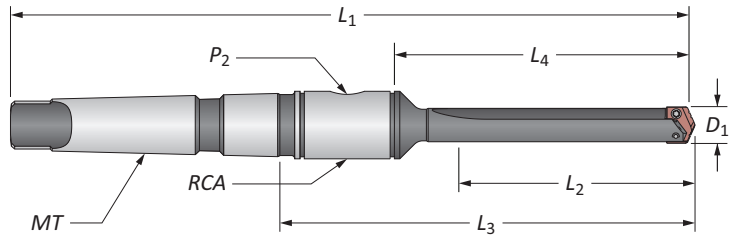

Straight Flute

Length	D ₁	Body				Shank			Part No.
		L ₂	L ₄	L ₃	L ₁	MT	P ₂	RCA	
Short	7/16 - 1/2	1-1/4	2-1/32	3-15/32	6-5/16	#2	1/16	2T-2SR	220Z0S-002I
Standard	7/16 - 1/2	2-3/8	3-5/32	4-19/32	7-7/16	#2	1/16	2T-2SR	240Z0S-002I
Extended	7/16 - 1/2	4-3/8	5-5/32	6-19/32	9-7/16	#2	1/16	2T-2SR	250Z0S-002I
Short	11.5 - 12.5	31.8	51.5	88.0	160.3	#2**	1/16*	2T-2SRM	220Z0S-002M

*Metric thread to BSP and ISO 7-1

**Per ISO 296 type BEK

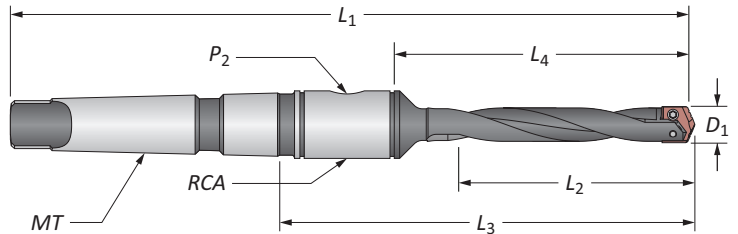

Helical Flute

Length	D ₁	Body				Shank			Part No.
		L ₂	L ₄	L ₃	L ₁	MT	P ₂	RCA	
Standard	7/16 - 1/2	2-3/8	3-5/32	4-19/32	7-7/16	#2	1/16	2T-2SR	240Z0H-002I
Extended	7/16 - 1/2	4-3/8	5-5/32	6-19/32	9-7/16	#2	1/16	2T-2SR	250Z0H-002I
Standard	11.5 - 12.5	60.3	80.2	116.7	188.9	#2**	1/16*	2T-2SRM	240Z0H-002M
Extended	11.5 - 12.5	111.1	130.9	167.4	239.7	#2**	1/16*	2T-2SRM	250Z0H-002M

*Metric thread to BSP and ISO 7-1

**Per ISO 296 type BEK

Connection Accessories

Insert Screws	Nylon Locking Screws	Insert Driver	Preset Torque Hand Driver	Replacement Tips	Admissible Tightening Torque*
7247-IP7-1	7247N-IP7-1	8IP-7	8IP-7TL	8IP-7B	7.4 in-lbs (84 N-cm)

*Tightening torques are calculated with a friction coefficient of $\mu = 0.14$ and develop 90% of ultimate yield strength

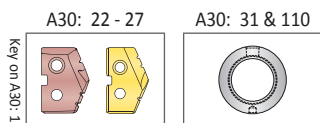

i = Imperial (in)

m = Metric (mm)

Screws sold in quantities of 10

WARNING Refer to Speed and Feed charts for recommended adjustments to speeds and feeds. Refer to page A30: 146 for deep hole drilling guidelines in this section of the catalog. Visit www.alliedmachine.com/DeepHoleGuidelines for the most up-to-date information and procedures. Factory technical assistance is available for your specific applications through our Application Engineering Team.



T-A Drill Insert Holders

Z Series | Straight Shank | ER Collet

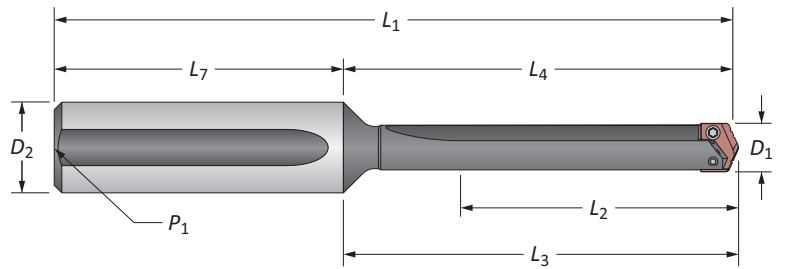

Straight Flute

Length	D ₁	Body				Shank			Part No.
		L ₂	L ₄	L ₃	L ₁	D ₂	L ₇	P ₁	
Short	7/16 - 1/2	1-1/4	2-1/32	2-1/8	4-13/32	3/4	2-3/8	1/8	220Z0S-075L
Standard	7/16 - 1/2	2-3/8	3-5/32	3-1/4	5-17/32	3/4	2-3/8	1/8	240Z0S-075L
Extended	7/16 - 1/2	4-3/8	5-5/32	5-1/4	7-17/32	3/4	2-3/8	1/8	250Z0S-075L
XL	7/16 - 1/2	8-3/4	9-17/32	9-5/8	11-29/32	3/4	2-3/8	1/8	270Z0S-075L
3XL	7/16 - 1/2	11-7/16	12-7/32	12-5/16	14-19/32	3/4	2-3/8	1/8	290Z0S-075L

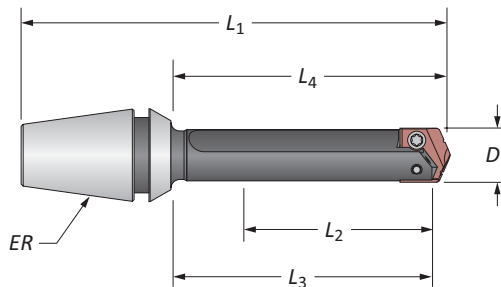

ER Collet Holder

D ₁	L ₂	Body			ER	Part No.	Collet Nut without Retaining Ring
		L ₄	L ₃	L ₁			
7/16 - 1/2	1-3/8	1-29/32	2	3-5/64	ER-16	210Z0S-16ER	ER-16N
7/16 - 1/2	1-3/8	1-29/32	2	3-15/64	ER-20	210Z0S-20ER	ER-20N

T-A Drill Accessories

Z Series | Rotary Coolant Adapters | Torx® Plus Screws

Rotary Coolant Adapter (RCA) and Accessories

ID	OD	L ₁	Driving Rod Thread	P ₁	Part No.	RCA O-Rings	
						Kit Part No.**	Replacements
3/4	1-3/4	7/8	5/16-18	1/8	2T-2SR	2T1-2SR	2T1-2OR-10
19.05	44.45	22.23	M8 x 1.25	1/8*	2T-2SRM	2T1-2SR	2T1-2OR-10

*Thread to BSP and ISO 7-1 | **RCA Repair Kit includes (2) O-rings, (2) snap rings, and (2) thrust washers

▲ Refer to page A30: 110 for proper RCA assembly and safety information

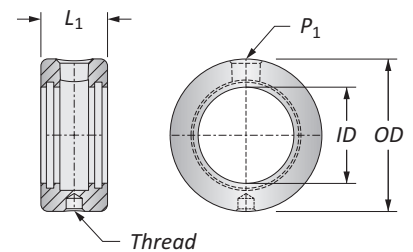

Connection Accessories

Insert Screws	Nylon Locking Screws	Insert Driver	Preset Torque Hand Driver	Replacement Tips	Admissible Tightening Torque*
7247-IP7-1	7247N-IP7-1	8IP-7	8IP-7TL	8IP-7B	7.4 in-lbs (84 N-cm)

*Tightening torques are calculated with a friction coefficient of $\mu = 0.14$ and develop 90% of ultimate yield strength

WARNING Refer to Speed and Feed charts for recommended adjustments to speeds and feeds. Refer to page A30: 146 for deep hole drilling guidelines in this section of the catalog. Visit www.alliedmachine.com/DeepHoleGuidelines for the most up-to-date information and procedures. Factory technical assistance is available for your specific applications through our Application Engineering Team.

ⓘ = Imperial (in)
Ⓜ = Metric (mm)

Screws sold in packs of 10
O-rings sold in packs of 10

GEN2 T-A Drill Inserts

0 Series | Diameter Range: 0.511" - 0.695" (12.98mm - 17.65mm)

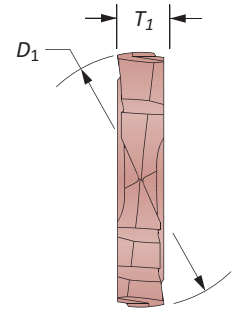
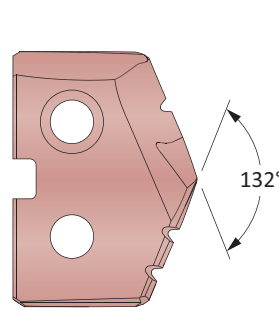
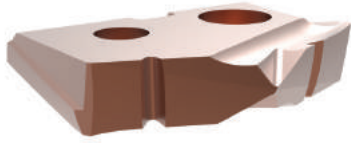

HSS Inserts – Super Cobalt • Carbide Inserts – C2 (K20) | C1 (K35)

Series	Fractional Equivalent	Insert			HSS Part No.			Carbide Part No.		
		D_1 inch	D_1 mm	T_1	Super Cobalt	C2 (K20)	C1 (K35)			
0	-	0.5118	13.00	1/8	450H-13	4C20H-13	4C10H-13			
	33/64	0.5156	13.10	1/8	450H-.515	4C20H-.515	4C10H-.515			
	17/32	0.5313	13.49	1/8	450H-0017	4C20H-0017	4C10H-0017			
	-	0.5315	13.50	1/8	450H-13.5	4C20H-13.5	4C10H-13.5			
	35/64	0.5469	13.89	1/8	450H-.546	4C20H-.546	4C10H-.546			
	-	0.5512	14.00	1/8	450H-14	4C20H-14	4C10H-14			
	9/16	0.5625	14.29	1/8	450H-0018	4C20H-0018	4C10H-0018			
	-	0.5709	14.50	1/8	450H-14.5	4C20H-14.5	4C10H-14.5			
	37/64	0.5781	14.68	1/8	450H-.578	4C20H-.578	4C10H-.578			
	-	0.5906	15.00	1/8	450H-15	4C20H-15	4C10H-15			
0.5	19/32	0.5938	15.08	1/8	450H-0019	4C20H-0019	4C10H-0019			
	39/64	0.6094	15.48	1/8	450H-.609	4C20H-.609	4C10H-.609			
	-	0.6102	15.50	1/8	450H-15.5	4C20H-15.5	4C10H-15.5			
	5/8	0.6250	15.88	1/8	450H-0020	4C20H-0020	4C10H-0020			
	-	0.6299	16.00	1/8	450H-16	4C20H-16	4C10H-16			
	41/64	0.6406	16.27	1/8	450H-.640	4C20H-.640	4C10H-.640			
	-	0.6496	16.50	1/8	450H-16.5	4C20H-16.5	4C10H-16.5			
	21/32	0.6563	16.67	1/8	450H-0021	4C20H-0021	4C10H-0021			
	-	0.6693	17.00	1/8	450H-17	4C20H-17	4C10H-17			
	43/64	0.6719	17.07	1/8	450H-.671	4C20H-.671	4C10H-.671			
11/16	0.6875	17.46	1/8	450H-0022	4C20H-0022	4C10H-0022				
-	0.6890	17.50	1/8	450H-17.5	4C20H-17.5	4C10H-17.5				

NOTE: 0.5 series inserts fit into both 0 and 0.5 series holders. However, 0 series inserts ONLY fit into 0 series holders. See page A30: 7 for visual.

A30: 112 - 143

Key on A30: 1

A30: 38 - 42

A30: 4 - 6

HE

Coatings not listed above can be supplied as non-stocked standards. Process fees apply. →

TiN = 131T-XXXX	TiAlN = 131A-XXXX
TiCN = 131N-XXXX	AM200® = 131H-XXXX



Inserts sold in quantities of 2

Original T-A Drill Inserts

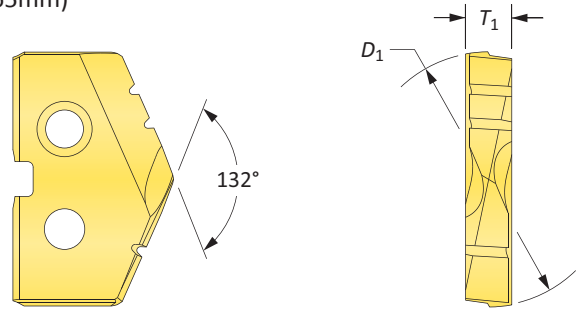
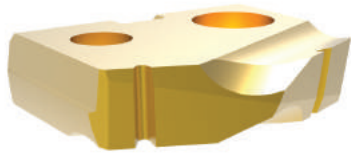
0 Series | HSS | Diameter Range: 0.511" - 0.695" (12.98mm - 17.65mm)



HSS Inserts – Premium Cobalt

Series	Fractional Equivalent	Insert			Part No.		
		D ₁ inch	D ₁ mm	T ₁	 TiN	 TiAlN	 TiCN
0	–	0.5118	13.00	1/8	180T-13	180A-13	180N-13
	33/64	0.5156	13.10	1/8	180T-.515	180A-.515	180N-.515
	17/32	0.5313	13.49	1/8	180T-0017	180A-0017	180N-0017
	–	0.5315	13.50	1/8	180T-13.5	180A-13.5	180N-13.5
	35/64	0.5469	13.89	1/8	180T-.546	180A-.546	180N-.546
	–	0.5512	14.00	1/8	180T-14	180A-14	180N-14
	9/16	0.5625	14.29	1/8	180T-0018	180A-0018	180N-0018
	–	0.5709	14.50	1/8	180T-14.5	180A-14.5	180N-14.5
	37/64	0.5781	14.68	1/8	180T-.578	180A-.578	180N-.578
	–	0.5906	15.00	1/8	180T-15	180A-15	180N-15
19/32	0.5938	15.08	1/8	180T-0019	180A-0019	180N-0019	
0.5	39/64	0.6094	15.48	1/8	180T-.609	180A-.609	180N-.609
	–	0.6102	15.50	1/8	180T-15.5	180A-15.5	180N-15.5
	5/8	0.6250	15.88	1/8	180T-0020	180A-0020	180N-0020
	–	0.6299	16.00	1/8	180T-16	180A-16	180N-16
	41/64	0.6406	16.27	1/8	180T-.640	180A-.640	180N-.640
	–	0.6496	16.50	1/8	180T-16.5	180A-16.5	180N-16.5
	21/32	0.6563	16.67	1/8	180T-0021	180A-0021	180N-0021
	–	0.6693	17.00	1/8	180T-17	180A-17	180N-17
	43/64	0.6719	17.07	1/8	180T-.671	180A-.671	180N-.671
	11/16	0.6875	17.46	1/8	180T-0022	180A-0022	180N-0022
–	0.6890	17.50	1/8	180T-17.5	180A-17.5	180N-17.5	

NOTE: 0.5 series inserts fit into both 0 and 0.5 series holders. However, 0 series inserts ONLY fit into 0 series holders. See page A30: 7 for visual.

A30: 112 - 143

A30: 38 - 42

A30: 4 - 6

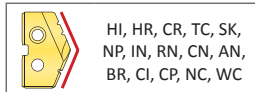
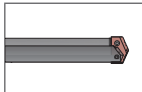
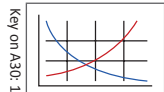

Coatings not listed above can be supplied as non-stocked standards. Process fees apply. →

Inserts sold in quantities of 2



TiN = 131T-XXXX	TiAlN = 131A-XXXX
TiCN = 131N-XXXX	AM200® = 131H-XXXX

Original T-A Drill Inserts

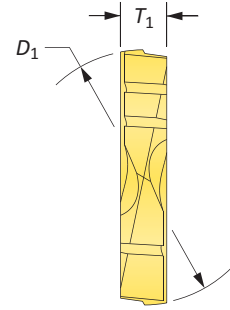
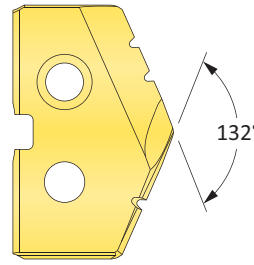
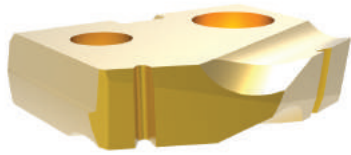
0 Series | HSS | Diameter Range: 0.511" - 0.695" (12.98mm - 17.65mm)



HSS Inserts – Super Cobalt

Series	Fractional Equivalent	Insert			Part No.		
		D_1 inch	D_1 mm	T_1	 TiN	 TiAlN	 TiCN
0	-	0.5118	13.00	1/8	150T-13	150A-13	150N-13
	33/64	0.5156	13.10	1/8	150T-.515	150A-.515	150N-.515
	17/32	0.5313	13.49	1/8	150T-0017	150A-0017	150N-0017
	-	0.5315	13.50	1/8	150T-13.5	150A-13.5	150N-13.5
	35/64	0.5469	13.89	1/8	150T-.546	150A-.546	150N-.546
	-	0.5512	14.00	1/8	150T-14	150A-14	150N-14
	9/16	0.5625	14.29	1/8	150T-0018	150A-0018	150N-0018
	-	0.5709	14.50	1/8	150T-14.5	150A-14.5	150N-14.5
	37/64	0.5781	14.68	1/8	150T-.578	150A-.578	150N-.578
	-	0.5906	15.00	1/8	150T-15	150A-15	150N-15
19/32	0.5938	15.08	1/8	150T-0019	150A-0019	150N-0019	
39/64	0.6094	15.48	1/8	150T-.609	150A-.609	150N-.609	
-	0.6102	15.50	1/8	150T-15.5	150A-15.5	150N-15.5	
5/8	0.6250	15.88	1/8	150T-0020	150A-0020	150N-0020	
-	0.6299	16.00	1/8	150T-16	150A-16	150N-16	
41/64	0.6406	16.27	1/8	150T-.640	150A-.640	150N-.640	
-	0.6496	16.50	1/8	150T-16.5	150A-16.5	150N-16.5	
21/32	0.6563	16.67	1/8	150T-0021	150A-0021	150N-0021	
-	0.6693	17.00	1/8	150T-17	150A-17	150N-17	
43/64	0.6719	17.07	1/8	150T-.671	150A-.671	150N-.671	
11/16	0.6875	17.46	1/8	150T-0022	150A-0022	150N-0022	
-	0.6890	17.50	1/8	150T-17.5	150A-17.5	150N-17.5	

NOTE: 0.5 series inserts fit into both 0 and 0.5 series holders. However, 0 series inserts ONLY fit into 0 series holders. See page A30: 7 for visual.

A30: 112 - 143

A30: 38 - 42

A30: 4 - 6

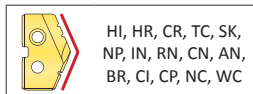
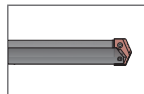
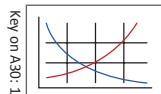

Coatings not listed above can be supplied as non-stocked standards. Process fees apply. →

TiN = 131T-XXXX	TiAlN = 131A-XXXX
TiCN = 131N-XXXX	AM200® = 131H-XXXX

Inserts sold in quantities of 2

Original T-A Drill Inserts

0 Series | HSS | Diameter Range: 0.511" - 0.695" (12.98mm - 17.65mm)





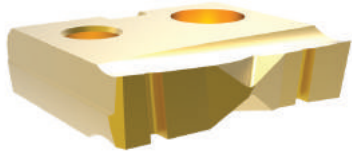
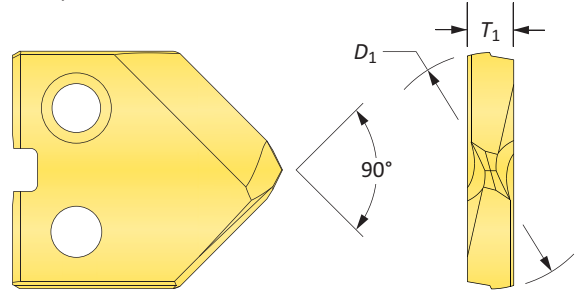

90° Spot & Chamfer

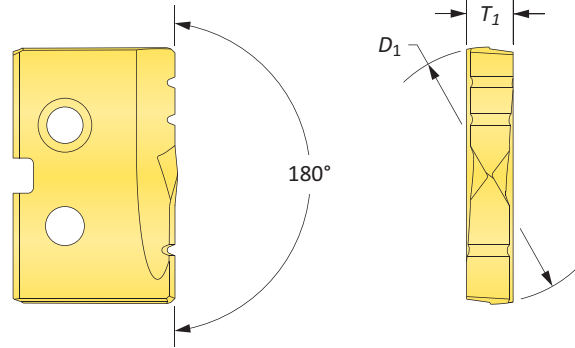

Flat Bottom



HSS Inserts – Super Cobalt

Series	Insert				90° Spot & Chamfer Part No.			Flat Bottom Part No.
	Fractional Equivalent	D ₁ inch	D ₁ mm	T ₁	 TIN	 TiAlN	 TiCN	 TIN
0	-	0.5118	13.00	1/8	150T-13-SP	150A-13-SP	150N-13-SP	150T-13-FB
	33/64	0.5156	13.10	1/8	150T-515-SP	150A-515-SP	150N-515-SP	150T-515-FB
	17/32	0.5313	13.49	1/8	150T-0017-SP	150A-0017-SP	150N-0017-SP	150T-0017-FB
	-	0.5315	13.50	1/8	150T-13.5-SP	150A-13.5-SP	150N-13.5-SP	150T-13.5-FB
	35/64	0.5469	13.89	1/8	150T-546-SP	150A-546-SP	150N-546-SP	150T-546-FB
	-	0.5512	14.00	1/8	150T-14-SP	150A-14-SP	150N-14-SP	150T-14-FB
	9/16	0.5625	14.29	1/8	150T-0018-SP	150A-0018-SP	150N-0018-SP	150T-0018-FB
	-	0.5709	14.50	1/8	150T-14.5-SP	150A-14.5-SP	150N-14.5-SP	150T-14.5-FB
	37/64	0.5781	14.68	1/8	150T-578-SP	150A-578-SP	150N-578-SP	150T-578-FB
0.5	-	0.5906	15.00	1/8	150T-15-SP	150A-15-SP	150N-15-SP	150T-15-FB
	19/32	0.5938	15.08	1/8	150T-0019-SP	150A-0019-SP	150N-0019-SP	150T-0019-FB
	39/64	0.6094	15.48	1/8	150T-609-SP	150A-609-SP	150N-609-SP	150T-609-FB
	-	0.6102	15.50	1/8	150T-15.5-SP	150A-15.5-SP	150N-15.5-SP	150T-15.5-FB
	5/8	0.6250	15.88	1/8	150T-0020-SP	150A-0020-SP	150N-0020-SP	150T-0020-FB
	-	0.6299	16.00	1/8	150T-16-SP	150A-16-SP	150N-16-SP	150T-16-FB
	41/64	0.6406	16.27	1/8	150T-640-SP	150A-640-SP	150N-640-SP	150T-640-FB
	-	0.6496	16.50	1/8	150T-16.5-SP	150A-16.5-SP	150N-16.5-SP	150T-16.5-FB
	21/32	0.6563	16.67	1/8	150T-0021-SP	150A-0021-SP	150N-0021-SP	150T-0021-FB
	-	0.6693	17.00	1/8	150T-17-SP	150A-17-SP	150N-17-SP	150T-17-FB
	43/64	0.6719	17.07	1/8	150T-671-SP	150A-671-SP	150N-671-SP	150T-671-FB
-	0.6875	17.46	1/8	150T-0022-SP	150A-0022-SP	150N-0022-SP	150T-0022-FB	
-	0.6890	17.50	1/8	150T-17.5-SP	150A-17.5-SP	150N-17.5-SP	150T-17.5-FB	

NOTE: 0.5 series inserts fit into both 0 and 0.5 series holders. However, 0 series inserts ONLY fit into 0 series holders. See page A30: 7 for visual.

A30: 112 - 143

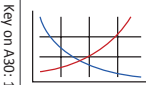

Key on A30: 1

A30: 38 - 42



A30: 4 - 6



SW

A30: 4 - 6

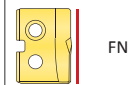

FN

Coatings not listed above can be supplied as non-stocked standards. Process fees apply. →

TiN = 131T-XXXX	TiAlN = 131A-XXXX
TiCN = 131N-XXXX	AM200® = 131H-XXXX

Inserts sold in quantities of 2

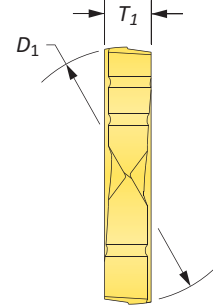
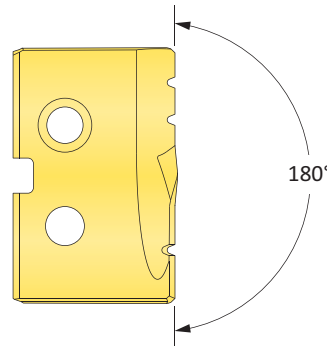
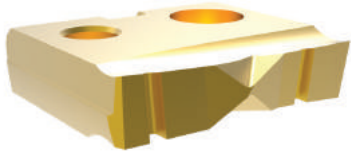
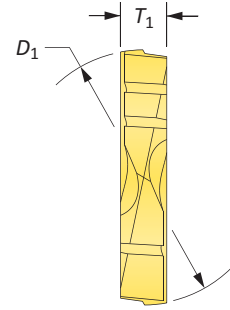
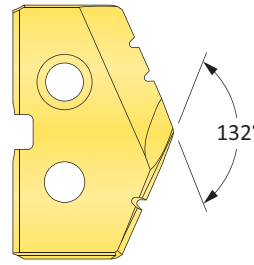
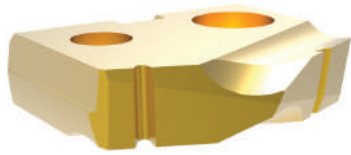

Original T-A Drill Inserts

0 Series | Carbide | Diameter Range: 0.511" - 0.695" (12.98mm - 17.65mm)



Flat Bottom

Carbide Inserts – C2 (K20)

Series	Fractional Equivalent	Insert			Part No.		Flat Bottom Part No.
		D ₁ inch	D ₁ mm	T ₁	 TIN	 TiAlN	 TiN
0	-	0.5118	13.00	1/8	1C20T-13	1C20A-13	1C20T-13-FB
	33/64	0.5156	13.10	1/8	1C20T-.515	1C20A-.515	1C20T-.515-FB
	17/32	0.5313	13.49	1/8	1C20T-0017	1C20A-0017	1C20T-0017-FB
	-	0.5315	13.50	1/8	1C20T-13.5	1C20A-13.5	1C20T-13.5-FB
	35/64	0.5469	13.89	1/8	1C20T-.546	1C20A-.546	1C20T-.546-FB
	-	0.5512	14.00	1/8	1C20T-14	1C20A-14	1C20T-14-FB
	9/16	0.5625	14.29	1/8	1C20T-0018	1C20A-0018	1C20T-0018-FB
	-	0.5709	14.50	1/8	1C20T-14.5	1C20A-14.5	1C20T-14.5-FB
	37/64	0.5781	14.68	1/8	1C20T-.578	1C20A-.578	1C20T-.578-FB
	-	0.5906	15.00	1/8	1C20T-15	1C20A-15	1C20T-15-FB
19/32	0.5938	15.08	1/8	1C20T-0019	1C20A-0019	1C20T-0019-FB	
0.5	39/64	0.6094	15.48	1/8	1C20T-.609	1C20A-.609	1C20T-.609-FB
	-	0.6102	15.50	1/8	1C20T-15.5	1C20A-15.5	1C20T-15.5-FB
	5/8	0.6250	15.88	1/8	1C20T-0020	1C20A-0020	1C20T-0020-FB
	-	0.6299	16.00	1/8	1C20T-16	1C20A-16	1C20T-16-FB
	41/64	0.6406	16.27	1/8	1C20T-.640	1C20A-.640	1C20T-.640-FB
	-	0.6496	16.50	1/8	1C20T-16.5	1C20A-16.5	1C20T-16.5-FB
	21/32	0.6563	16.67	1/8	1C20T-0021	1C20A-0021	1C20T-0021-FB
	-	0.6693	17.00	1/8	1C20T-17	1C20A-17	1C20T-17-FB
	43/64	0.6719	17.07	1/8	1C20T-.671	1C20A-.671	1C20T-.671-FB
	11/16	0.6875	17.46	1/8	1C20T-0022	1C20A-0022	1C20T-0022-FB
-	0.6890	17.50	1/8	1C20T-17.5	1C20A-17.5	1C20T-17.5-FB	

NOTE: 0.5 series inserts fit into both 0 and 0.5 series holders. However, 0 series inserts ONLY fit into 0 series holders. See page A30: 7 for visual.

Inserts sold in quantities of 2

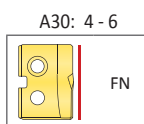
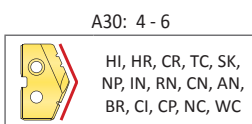
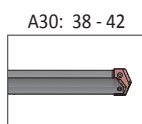
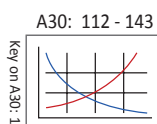

Coatings not listed above can be supplied as non-stocked standards. Process fees apply. →



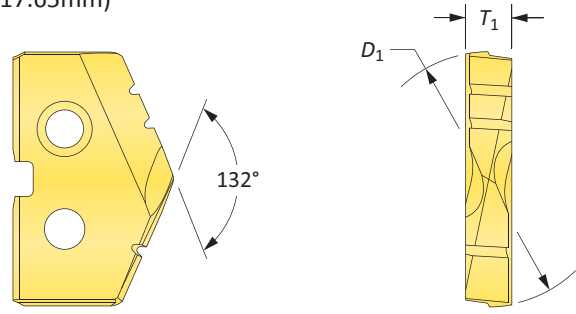
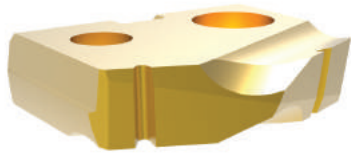

TiN = 131T-XXXX	TiAlN = 131A-XXXX
TiCN = 131N-XXXX	AM200® = 131H-XXXX

Original T-A Drill Inserts

0 Series | Carbide | Diameter Range: 0.511" - 0.695" (12.98mm - 17.65mm)



Carbide Inserts – C5 (P40) | C3 (K10) | N2

Series	Insert				C5 Part No.		C3 Part No.	N2 Part No.
	Fractional Equivalent	D ₁ inch	D ₁ mm	T ₁	 TIN	 TiAlN	 TiAlN (Cast Iron)	 Diamond Film
0	-	0.5118	13.00	1/8	1C50T-13	1C50A-13	1C30A-13-CI	1N20D-13
	33/64	0.5156	13.10	1/8	1C50T-.515	1C50A-.515	1C30A-.515-CI	1N20D-.515
	17/32	0.5313	13.49	1/8	1C50T-0017	1C50A-0017	1C30A-0017-CI	1N20D-0017
	-	0.5315	13.50	1/8	1C50T-13.5	1C50A-13.5	1C30A-13.5-CI	1N20D-13.5
	35/64	0.5469	13.89	1/8	1C50T-.546	1C50A-.546	1C30A-.546-CI	1N20D-.546
	-	0.5512	14.00	1/8	1C50T-14	1C50A-14	1C30A-14-CI	1N20D-14
	9/16	0.5625	14.29	1/8	1C50T-0018	1C50A-0018	1C30A-0018-CI	1N20D-0018
	-	0.5709	14.50	1/8	1C50T-14.5	1C50A-14.5	1C30A-14.5-CI	1N20D-14.5
	37/64	0.5781	14.68	1/8	1C50T-.578	1C50A-.578	1C30A-.578-CI	1N20D-.578
	-	0.5906	15.00	1/8	1C50T-15	1C50A-15	1C30A-15-CI	1N20D-15
19/32	0.5938	15.08	1/8	1C50T-0019	1C50A-0019	1C30A-0019-CI	1N20D-0019	
0.5	39/64	0.6094	15.48	1/8	1C50T-.609	1C50A-.609	1C30A-.609-CI	1N20D-.609
	-	0.6102	15.50	1/8	1C50T-15.5	1C50A-15.5	1C30A-15.5-CI	1N20D-15.5
	5/8	0.6250	15.88	1/8	1C50T-0020	1C50A-0020	1C30A-0020-CI	1N20D-0020
	-	0.6299	16.00	1/8	1C50T-16	1C50A-16	1C30A-16-CI	1N20D-16
	41/64	0.6406	16.27	1/8	1C50T-.640	1C50A-.640	1C30A-.640-CI	1N20D-.640
	-	0.6496	16.50	1/8	1C50T-16.5	1C50A-16.5	1C30A-16.5-CI	1N20D-16.5
	21/32	0.6563	16.67	1/8	1C50T-0021	1C50A-0021	1C30A-0021-CI	1N20D-0021
	-	0.6693	17.00	1/8	1C50T-17	1C50A-17	1C30A-17-CI	1N20D-17
	43/64	0.6719	17.07	1/8	1C50T-.671	1C50A-.671	1C30A-.671-CI	1N20D-.671
	11/16	0.6875	17.46	1/8	1C50T-0022	1C50A-0022	1C30A-0022-CI	1N20D-0022
-	0.6890	17.50	1/8	1C50T-17.5	1C50A-17.5	1C30A-17.5-CI	1N20D-17.5	

NOTE: 0.5 series inserts fit into both 0 and 0.5 series holders. However, 0 series inserts ONLY fit into 0 series holders. See page A30: 7 for visual.

A30: 112 - 143

A30: 38 - 42

A30: 4 - 6

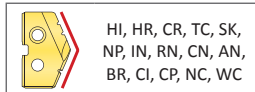
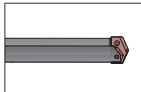
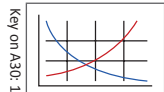

Coatings not listed above can be supplied as non-stocked standards. Process fees apply. →

Inserts sold in quantities of 2

TiN = 131T-XXXX	TiAlN = 131A-XXXX
TiCN = 131N-XXXX	AM200® = 131H-XXXX

T-A Drill Insert Holders

0 Series | Flange Shank

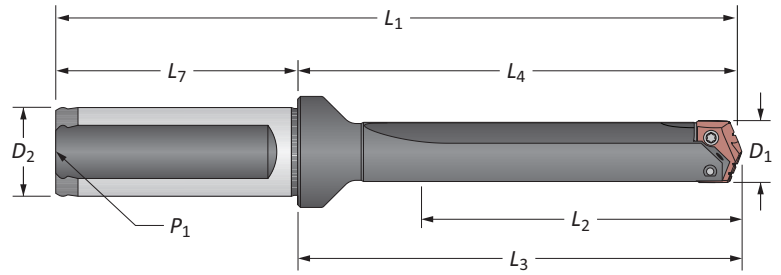

Stub Length

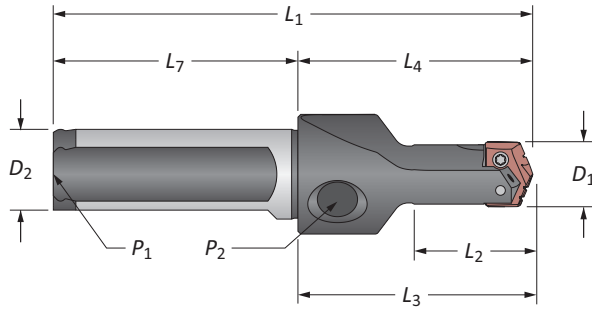

Straight Flute

Series	Length	D ₁	Body				Shank			Part No.	
			L ₂	L ₄	L ₃	L ₁	D ₂	L ₇	P ₁		
0	Stub	33/64 - 11/16	7/8	1-7/8	1-63/64	3-29/32	3/4	2-1/32	1/8	21000S-075F	
	Short	33/64 - 11/16	1-3/8	2-1/2	2-39/64	4-17/32	3/4	2-1/32	1/8	22000S-075F	
	Standard	33/64 - 11/16	2-1/2	3-5/8	3-47/64	5-21/32	3/4	2-1/32	1/8	24000S-075F	
	Extended	33/64 - 11/16	4-1/2	5-5/8	5-47/64	7-21/32	3/4	2-1/32	1/8	▲ 25000S-075F	
0.5	Stub	39/64 - 11/16	7/8	1-7/8	1-63/64	3-29/32	3/4	2-1/32	1/8	21005S-075F	
	Short	39/64 - 11/16	1-3/8	2-1/2	2-39/64	4-17/32	3/4	2-1/32	1/8	22005S-075F	
	Standard	39/64 - 11/16	2-1/2	3-5/8	3-47/64	5-21/32	3/4	2-1/32	1/8	24005S-075F	
	Extended	39/64 - 11/16	4-1/2	5-5/8	5-47/64	7-21/32	3/4	2-1/32	1/8	▲ 25005S-075F	
m	0	Stub	13.0 - 17.5	22.2	47.6	50.4	97.6	20.0	50.0	1/8*	21000S-20FM
		Short	13.0 - 17.5	34.9	63.5	66.3	113.5	20.0	50.0	1/8*	22000S-20FM
		XL	13.0 - 17.5	295.0	323.9	326.7	373.9	20.0	50.0	1/8*	▲ 27000S-20FM
		3XL	13.0 - 17.5	387.0	416.0	418.8	466.0	20.0	50.0	1/8*	▲ 29000S-20FM
	0.5	Stub	15.5 - 17.5	22.2	47.6	50.4	97.6	20.0	50.0	1/8*	21005S-20FM
Short	15.5 - 17.5	34.9	63.5	66.3	113.5	20.0	50.0	1/8*	22005S-20FM		

*Metric thread to BSP and ISO 7-1

NOTE: Stub length holders have a 1/8" side pipe tap (P₂)

Connection Accessories

Series	Insert Screws	Nylon Locking Screws	Insert Driver	Preset Torque Hand Driver	Replacement Tips	Admissible Tightening Torque*
0	72556-IP8-1	72556N-IP8-1	8IP-8	8IP-8TL	8IP-8B	15.5 in-lbs (175 N-cm)
0.5	72567-IP8-1	72567N-IP8-1	8IP-8	8IP-8TL	8IP-8B	15.5 in-lbs (175 N-cm)

*Tightening torques are calculated with a friction coefficient of $\mu = 0.14$ and develop 90% of ultimate yield strength

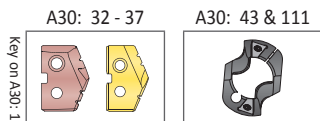

i = Imperial (in)
m = Metric (mm)

Screws sold in quantities of 10

WARNING Refer to Speed and Feed charts for recommended adjustments to speeds and feeds. Refer to page A30: 146 for deep hole drilling guidelines in this section of the catalog. Visit www.alliedmachine.com/DeepHoleGuidelines for the most up-to-date information and procedures. Factory technical assistance is available for your specific applications through our Application Engineering Team.

T-A Drill Insert Holders

O Series | Flange Shank

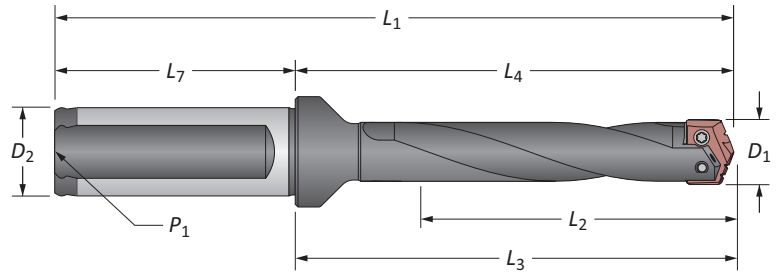





Helical Flute

Series	Length	Body					Shank			Part No.
		D ₁	L ₂	L ₄	L ₃	L ₁	D ₂	L ₇	P ₁	
i	Standard	33/64 - 11/16	2-1/2	3-5/8	3-47/64	5-21/32	3/4	2-1/32	1/8	24000H-075F
	Standard Plus	33/64 - 11/16	3-1/2	4-5/8	4-37/64	6-39/64	3/4	2-1/32	1/8	24500H-075F
	Extended	33/64 - 11/16	4-1/2	5-5/8	5-47/64	7-21/32	3/4	2-1/32	1/8	⚠ 25000H-075F
	Long	33/64 - 11/16	7	8-1/8	8-15/64	10-5/32	3/4	2-1/32	1/8	⚠ 26000H-075F
0	Standard	33/64 - 11/16	9-7/16	10-37/64	10-11/16	12-23/32	3/4	2-1/32	1/8	⚠ 26500H-075F
	Standard	39/64 - 11/16	2-1/2	3-5/8	3-47/64	5-21/32	3/4	2-1/32	1/8	24005H-075F
	Extended	39/64 - 11/16	4-1/2	5-5/8	5-47/64	7-21/32	3/4	2-1/32	1/8	⚠ 25005H-075F
0.5	Long	39/64 - 11/16	7	8-1/8	8-15/64	10-5/32	3/4	2-1/32	1/8	⚠ 26005H-075F
ii	Standard	13.0 - 17.5	63.5	92.1	94.9	142.1	20.0	50.0	1/8*	24000H-20FM
	Standard Plus	13.0 - 17.5	89.0	117.6	120.4	167.6	20.0	50.0	1/8*	24500H-20FM
	Extended	13.0 - 17.5	114.3	142.9	145.7	192.9	20.0	50.0	1/8*	⚠ 25000H-20FM
	Long	13.0 - 17.5	177.8	206.4	209.1	256.4	20.0	50.0	1/8*	⚠ 26000H-20FM
	Long Plus	13.0 - 17.5	240.0	268.6	271.4	318.6	20.0	50.0	1/8*	⚠ 26500H-20FM
	Standard	15.5 - 17.5	63.5	92.1	94.9	142.1	20.0	50.0	1/8*	24005H-20FM
	Extended	15.5 - 17.5	114.3	142.9	145.7	192.9	20.0	50.0	1/8*	⚠ 25005H-20FM
	Long	15.5 - 17.5	177.8	206.4	209.1	256.4	20.0	50.0	1/8*	⚠ 26005H-20FM

*Metric thread to BSP and ISO 7-1

Connection Accessories

Series	 Insert Screws	 Nylon Locking Screws	 Insert Driver	 Preset Torque Hand Driver	 Replacement Tips	Admissible Tightening Torque*
0	72556-IP8-1	72556N-IP8-1	8IP-8	8IP-8TL	8IP-8B	15.5 in-lbs (175 N-cm)
0.5	72567-IP8-1	72567N-IP8-1	8IP-8	8IP-8TL	8IP-8B	15.5 in-lbs (175 N-cm)

*Tightening torques are calculated with a friction coefficient of $\mu = 0.14$ and develop 90% of ultimate yield strength

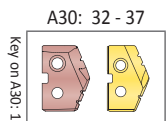

i = Imperial (in)
m = Metric (mm)

Screws sold in quantities of 10

⚠ WARNING Refer to Speed and Feed charts for recommended adjustments to speeds and feeds. Refer to page A30: 146 for deep hole drilling guidelines in this section of the catalog. Visit www.alliedmachine.com/DeepHoleGuidelines for the most up-to-date information and procedures. Factory technical assistance is available for your specific applications through our Application Engineering Team.

T-A Drill Insert Holders

0 Series | Taper Shank

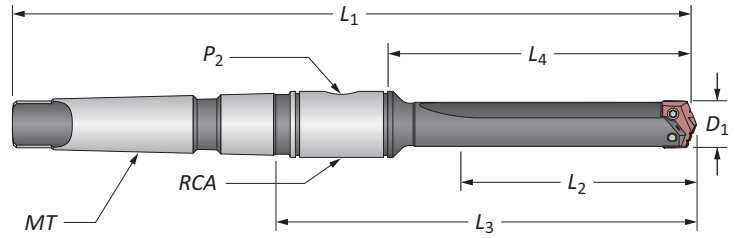

Straight Flute

Series	Length	D ₁	Body				Shank			Part No.
			L ₂	L ₃	L ₄	L ₁	MT	P ₂	RCA	
i 0	Short	33/64 - 11/16	1-3/8	3-41/64	2-3/16	6-15/32	#2	1/16	2T-2SR	22000S-002I
	Standard	33/64 - 11/16	2-1/2	4-49/64	3-5/16	7-19/32	#2	1/16	2T-2SR	24000S-002I
	Extended	33/64 - 11/16	4-1/2	6-49/64	5-5/16	9-19/32	#2	1/16	2T-2SR	25000S-002I
i 0.5	Short	39/64 - 11/16	1-3/8	3-41/64	2-3/16	6-15/32	#2	1/16	2T-2SR	22005S-002I
	Standard	39/64 - 11/16	2-1/2	4-49/64	3-5/16	7-19/32	#2	1/16	2T-2SR	24005S-002I
	Extended	39/64 - 11/16	4-1/2	6-49/64	5-5/16	9-19/32	#2	1/16	2T-2SR	25005S-002I
m 0	Short	13.0 - 17.5	35.0	92.4	55.5	164.3	#2**	1/16*	2T-2SRM	22000S-002M
	0.5	Short	15.5 - 17.5	35.0	92.4	55.5	164.3	#2**	1/16*	2T-2SRM

*Metric thread to BSP and ISO 7-1

**Per ISO 296 type BEK

Connection Accessories

Series	Insert Screws	Nylon Locking Screws	Insert Driver	Preset Torque Hand Driver	Replacement Tips	Admissible Tightening Torque*
0	72556-IP8-1	72556N-IP8-1	8IP-8	8IP-8TL	8IP-8B	15.5 in-lbs (175 N-cm)
0.5	72567-IP8-1	72567N-IP8-1	8IP-8	8IP-8TL	8IP-8B	15.5 in-lbs (175 N-cm)

*Tightening torques are calculated with a friction coefficient of $\mu = 0.14$ and develop 90% of ultimate yield strength

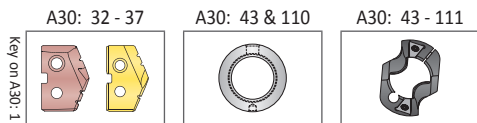

i = Imperial (in)
m = Metric (mm)

Screws sold in quantities of 10

WARNING Refer to Speed and Feed charts for recommended adjustments to speeds and feeds. Refer to page A30: 146 for deep hole drilling guidelines in this section of the catalog. Visit www.alliedmachine.com/DeepHoleGuidelines for the most up-to-date information and procedures. Factory technical assistance is available for your specific applications through our Application Engineering Team.



T-A Drill Insert Holders

O Series | Taper Shank

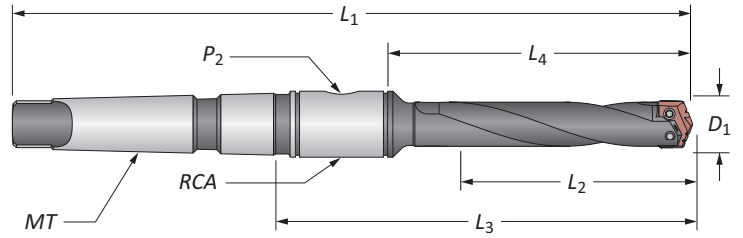

Helical Flute

Series	Length	D ₁	Body				Shank			Part No.
			L ₂	L ₃	L ₄	L ₁	MT	P ₂	RCA	
i	Standard	33/64 - 11/16	2-1/2	4-49/64	3-5/16	7-19/32	#2	1/16	2T-2SR	24000H-002I
	Extended	33/64 - 11/16	4-1/2	6-49/64	5-5/16	9-19/32	#2	1/16	2T-2SR	⚠ 25000H-002I
	Long	33/64 - 11/16	7	8-17/64	7-13/16	12-3/32	#2	1/16	2T-2SR	⚠ 26000H-002I
i	Standard	39/64 - 11/16	2-1/2	4-49/64	3-5/16	7-19/32	#2	1/16	2T-2SR	24005H-002I
	Extended	39/64 - 11/16	4-1/2	6-49/64	5-5/16	9-19/32	#2	1/16	2T-2SR	⚠ 25005H-002I
	Long	39/64 - 11/16	7	8-17/64	7-13/16	12-3/32	#2	1/16	2T-2SR	⚠ 26005H-002I
m	Standard	13.0 - 17.5	63.5	121.0	84.1	192.9	#2**	1/16*	2T-2SRM	24000H-002M
	Extended	13.0 - 17.5	114.3	171.8	135.0	243.7	#2**	1/16*	2T-2SRM	⚠ 25000H-002M
	Long	13.0 - 17.5	177.8	235.3	198.5	307.2	#2**	1/16*	2T-2SRM	⚠ 26000H-002M
m	Standard	15.5 - 17.5	63.5	121.0	84.1	192.9	#2**	1/16*	2T-2SRM	24005H-002M
	Extended	15.5 - 17.5	114.3	171.8	135.0	243.7	#2**	1/16*	2T-2SRM	⚠ 25005H-002M
	Long	15.5 - 17.5	177.8	235.3	198.5	307.2	#2**	1/16*	2T-2SRM	⚠ 26005H-002M

*Metric thread to BSP and ISO 7-1

**Per ISO 296 type BEK

Connection Accessories

Series	Insert Screws	Nylon Locking Screws	Insert Driver	Preset Torque Hand Driver	Replacement Tips	Admissible Tightening Torque*
0	72556-IP8-1	72556N-IP8-1	8IP-8	8IP-8TL	8IP-8B	15.5 in-lbs (175 N-cm)
0.5	72567-IP8-1	72567N-IP8-1	8IP-8	8IP-8TL	8IP-8B	15.5 in-lbs (175 N-cm)

*Tightening torques are calculated with a friction coefficient of $\mu = 0.14$ and develop 90% of ultimate yield strength

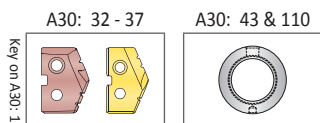

i = Imperial (in)
m = Metric (mm)

Screws sold in quantities of 10

⚠ WARNING Refer to Speed and Feed charts for recommended adjustments to speeds and feeds. Refer to page A30: 146 for deep hole drilling guidelines in this section of the catalog. Visit www.alliedmachine.com/DeepHoleGuidelines for the most up-to-date information and procedures. Factory technical assistance is available for your specific applications through our Application Engineering Team.

T-A Drill Insert Holders

0 Series | Straight Shank | ER Collet

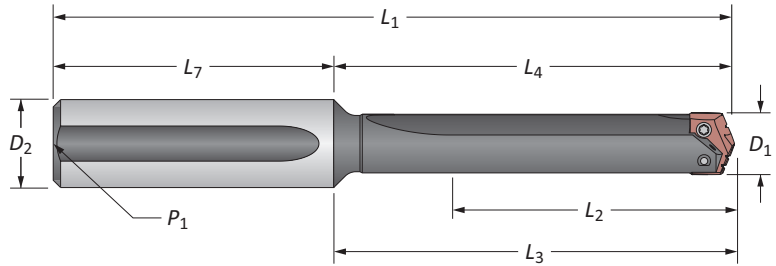

Straight Flute

Series	Length	D ₁	Body				Shank			Part No.
			L ₂	L ₄	L ₃	L ₁	D ₂	L ₇	P ₁	
0	Short	33/64 - 11/16	1-3/8	2-3/16	2-19/64	4-9/16	3/4	2-3/8	1/8	22000S-075L
	Standard	33/64 - 11/16	2-1/2	3-5/16	3-27/64	5-11/16	3/4	2-3/8	1/8	24000S-075L
	Extended	33/64 - 11/16	4-1/2	5-5/16	5-27/64	7-11/16	3/4	2-3/8	1/8	25000S-075L
	Long	33/64 - 11/16	7	7-13/16	7-59/64	10-3/16	3/4	2-3/8	1/8	26000S-075L
	XL	33/64 - 11/16	11-5/8	12-7/16	12-35/64	14-13/16	3/4	2-3/8	1/8	27000S-075L
0.5	3XL	33/64 - 11/16	15-1/4	16-1/16	16-11/64	18-7/16	3/4	2-3/8	1/8	29000S-075L
	Short	39/64 - 11/16	1-3/8	2-3/16	2-19/64	4-9/16	3/4	2-3/8	1/8*	22005S-075L
	Standard	39/64 - 11/16	2-1/2	3-5/16	3-27/64	5-11/16	3/4	2-3/8	1/8*	24005S-075L
	Extended	39/64 - 11/16	4-1/2	5-5/16	5-27/64	7-11/16	3/4	2-3/8	1/8*	25005S-075L
	Long	39/64 - 11/16	7	7-13/16	7-59/64	10-3/16	3/4	2-3/8	1/8*	26005S-075L

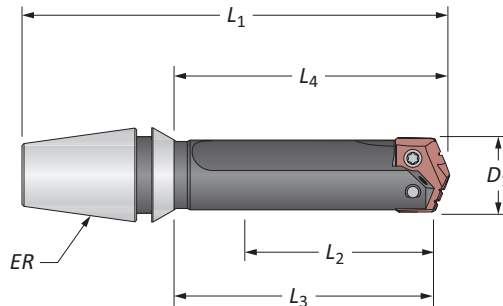

ER Collet Holder

Series	D ₁	L ₂	L ₄	Body			ER	Part No.	Collet Nut without Retaining Ring
				L ₃	L ₁				
0	33/64 - 11/16	1-3/8	1-57/64	2	3-5/64		ER-16	21000S-16ER	ER-16N
	33/64 - 11/16	1-3/8	1-57/64	2	3-15/64		ER-20	21000S-20ER	ER-20N

Connection Accessories

Series	Insert Screws	Nylon Locking Screws	Insert Driver	Preset Torque Hand Driver	Replacement Tips	Admissible Tightening Torque*
0	72556-IP8-1	72556N-IP8-1	8IP-8	8IP-8TL	8IP-8B	15.5 in-lbs (175 N-cm)
0.5	72567-IP8-1	72567N-IP8-1	8IP-8	8IP-8TL	8IP-8B	15.5 in-lbs (175 N-cm)

*Tightening torques are calculated with a friction coefficient of $\mu = 0.14$ and develop 90% of ultimate yield strength

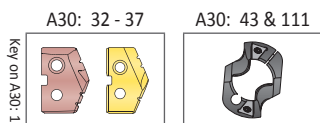

i = Imperial (in)
m = Metric (mm)

Screws sold in quantities of 10

WARNING Refer to Speed and Feed charts for recommended adjustments to speeds and feeds. Refer to page A30: 146 for deep hole drilling guidelines in this section of the catalog. Visit www.alliedmachine.com/DeepHoleGuidelines for the most up-to-date information and procedures. Factory technical assistance is available for your specific applications through our Application Engineering Team.



T-A Drill Accessories

O Series | Chamfer Rings | Rotary Coolant Adapters | Torx® Plus Screws

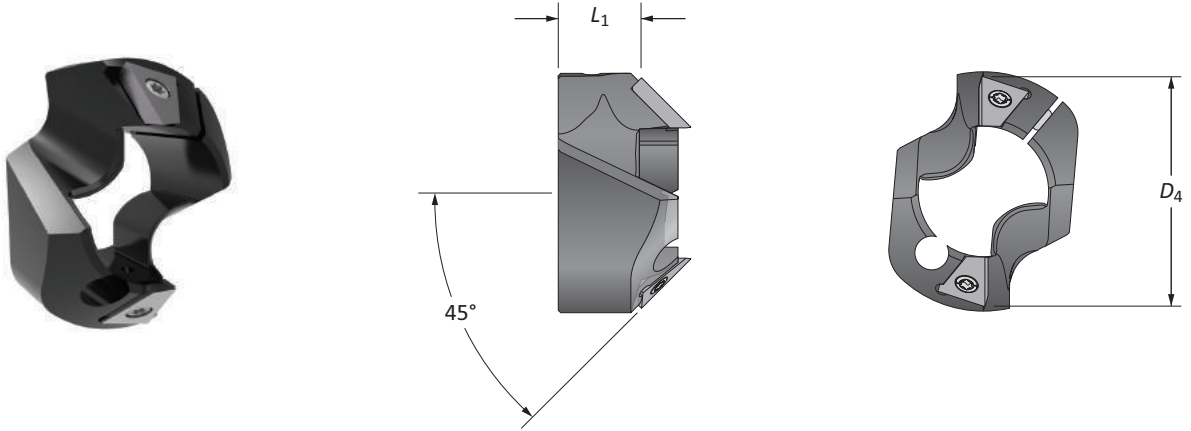

T-ACR 45 Chamfer Ring

Holder Series	D ₁ Range	Chamfer Ring		Part No.	Insert Part No.	Insert Screw	Insert Driver	Clamping Screw	Insert Driver
		D ₄	L ₁						
0	0.5118 - 0.6890	13/16	0.676	T-ACR-45-0	T-ACRI-45-B-C5A	7255-IP8-1	8IP-8	7375-IP9-1	8IP-9

Rotary Coolant Adapter (RCA) and Accessories

ID	OD	L ₁	Driving Rod Thread	P ₁	Part No.	RCA O-Rings	
						Kit Part No.**	Replacements
i 3/4	1-3/4	7/8	5/16-18	1/8	⚠ 2T-2SR	2T1-2SR	2T1-2OR-10
m 19.05	44.45	22.23	M8 x 1.25	1/8*	⚠ 2T-2SRM	2T1-2SR	2T1-2OR-10

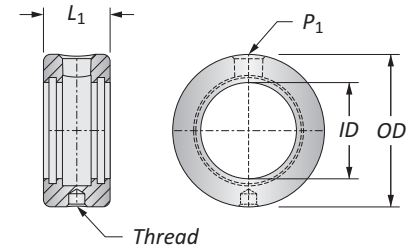

*Thread to BSP and ISO 7-1

**RCA Repair Kit includes (2) O-rings, (2) snap rings, and (2) thrust washers

⚠ Refer to page A30: 110 for proper RCA assembly and safety information

Connection Accessories

Series	Insert Screws	Nylon Locking Screws	Insert Driver	Preset Torque Hand Driver	Replacement Tips	Admissible Tightening Torque*
0	72556-IP8-1	72556N-IP8-1	8IP-8	8IP-8TL	8IP-8B	15.5 in-lbs (175 N-cm)
0.5	72567-IP8-1	72567N-IP8-1	8IP-8	8IP-8TL	8IP-8B	15.5 in-lbs (175 N-cm)

*Tightening torques are calculated with a friction coefficient of $\mu = 0.14$ and develop 90% of ultimate yield strength

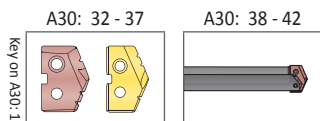

i = Imperial (in)

m = Metric (mm)

Chamfer Ring Inserts sold separately
Screws sold in packs of 10
O-rings sold in packs of 10



⚠ WARNING RCA rotation during drilling can cause hose and/or hose fitting failure, machinery damage, and/or serious injury. To prevent, use RCA and positive stop studs when drilling. Factory technical assistance is also available for your specific applications.

GEN2 T-A Drill Inserts

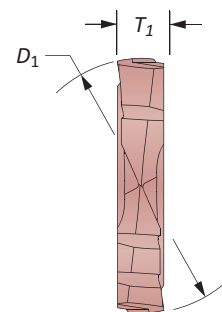
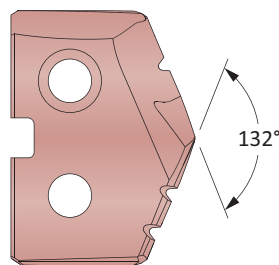
1 Series | Diameter Range: 0.690" - 0.960" (17.53mm - 24.38mm)



HSS Inserts – Super Cobalt • Carbide Inserts – C2 (K20) | C1 (K35)

Series	Fractional Equivalent	Insert			HSS Part No.	Carbide Part No.	
		D_1 inch	D_1 mm	T_1	 Super Cobalt	 C2	 C1
1	45/64	0.7031	17.86	5/32	451H-.703	4C21H-.703	4C11H-.703
	-	0.7087	18.00	5/32	451H-18	4C21H-18	4C11H-18
	23/32	0.7188	18.26	5/32	451H-0023	4C21H-0023	4C11H-0023
	-	0.7283	18.50	5/32	451H-18.5	4C21H-18.5	4C11H-18.5
	47/64	0.7344	18.65	5/32	451H-.734	4C21H-.734	4C11H-.734
	-	0.7480	19.00	5/32	451H-19	4C21H-19	4C11H-19
	3/4	0.7500	19.05	5/32	451H-0024	4C21H-0024	4C11H-0024
	49/64	0.7656	19.45	5/32	451H-.765	4C21H-.765	4C11H-.765
	-	0.7677	19.50	5/32	451H-19.5	4C21H-19.5	4C11H-19.5
	25/32	0.7813	19.84	5/32	451H-0025	4C21H-0025	4C11H-0025
	-	0.7874	20.00	5/32	451H-20	4C21H-20	4C11H-20
	51/64	0.7969	20.24	5/32	451H-.796	4C21H-.796	4C11H-.796
	-	0.8010	20.34	5/32	451H-.801	4C21H-.801	4C11H-.801
	-	0.8071	20.50	5/32	451H-20.5	4C21H-20.5	4C11H-20.5
	13/16	0.8125	20.64	5/32	451H-0026	4C21H-0026	4C11H-0026
	-	0.8268	21.00	5/32	451H-21	4C21H-21	4C11H-21
27/32	0.8438	21.43	5/32	451H-0027	4C21H-0027	4C11H-0027	
-	0.8465	21.50	5/32	451H-21.5	4C21H-21.5	4C11H-21.5	
1.5	55/64	0.8594	21.83	5/32	451H-.859	4C21H-.859	4C11H-.859
	-	0.8661	22.00	5/32	451H-22	4C21H-22	4C11H-22
	7/8	0.8750	22.23	5/32	451H-0028	4C21H-0028	4C11H-0028
	-	0.8858	22.50	5/32	451H-22.5	4C21H-22.5	4C11H-22.5
	57/64	0.8906	20.62	5/32	451H-.890	4C21H-.890	4C11H-.890
	-	0.9055	23.00	5/32	451H-23	4C21H-23	4C11H-23
	29/32	0.9063	23.02	5/32	451H-0029	4C21H-0029	4C11H-0029
	59/64	0.9219	23.42	5/32	451H-.921	4C21H-.921	4C11H-.921
	-	0.9252	23.50	5/32	451H-23.5	4C21H-23.5	4C11H-23.5
	15/16	0.9375	23.81	5/32	451H-0030	4C21H-0030	4C11H-0030
-	0.9449	24.00	5/32	451H-24	4C21H-24	4C11H-24	

NOTE: 1.5 series inserts fit into both 1 and 1.5 series holders. However, 1 series inserts ONLY fit into 1 series holders. See page A30: 7 for visual.

A30: 112 - 143

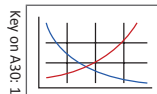

A30: 52 - 56

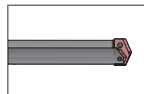

A30: 4 - 6

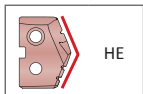

Coatings not listed above can be supplied as non-stocked standards. Process fees apply. →

TiN = 131T-XXXX

TiAlN = 131A-XXXX

TiCN = 131N-XXXX

AM200® = 131H-XXXX



Inserts sold in quantities of 2

Original T-A Drill Inserts

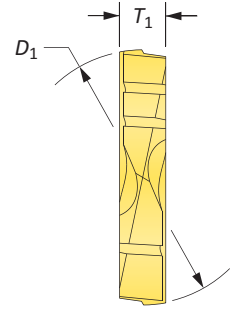
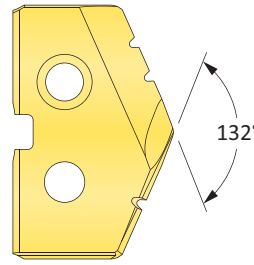
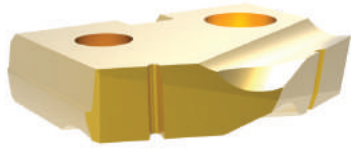
1 Series | HSS | Diameter Range: 0.690" - 0.960" (17.53mm - 24.38mm)





HSS Inserts – Premium Cobalt

Series	Fractional Equivalent	Insert			Part No.		
		D ₁ inch	D ₁ mm	T ₁	 TiN	 TiAlN	 TiCN
1	45/64	0.7031	17.86	5/32	181T-.703	181A-.703	181N-.703
	-	0.7087	18.00	5/32	181T-18	181A-18	181N-18
	23/32	0.7188	18.26	5/32	181T-0023	181A-0023	181N-0023
	-	0.7283	18.50	5/32	181T-18.5	181A-18.5	181N-18.5
	47/64	0.7344	18.65	5/32	181T-.734	181A-.734	181N-.734
	-	0.7480	19.00	5/32	181T-19	181A-19	181N-19
	3/4	0.7500	19.05	5/32	181T-0024	181A-0024	181N-0024
	49/64	0.7656	19.45	5/32	181T-.765	181A-.765	181N-.765
	-	0.7677	19.50	5/32	181T-19.5	181A-19.5	181N-19.5
	25/32	0.7813	19.84	5/32	181T-0025	181A-0025	181N-0025
	-	0.7874	20.00	5/32	181T-20	181A-20	181N-20
	51/64	0.7969	20.24	5/32	181T-.796	181A-.796	181N-.796
	-	0.8010	20.34	5/32	181T-.801	181A-.801	181N-.801
	-	0.8071	20.50	5/32	181T-20.5	181A-20.5	181N-20.5
	13/16	0.8125	20.64	5/32	181T-0026	181A-0026	181N-0026
-	0.8268	21.00	5/32	181T-21	181A-21	181N-21	
27/32	0.8438	21.43	5/32	181T-0027	181A-0027	181N-0027	
-	0.8465	21.50	5/32	181T-21.5	181A-21.5	181N-21.5	
1.5	55/64	0.8594	21.83	5/32	181T-.859	181A-.859	181N-.859
	-	0.8661	22.00	5/32	181T-22	181A-22	181N-22
	7/8	0.8750	22.23	5/32	181T-0028	181A-0028	181N-0028
	-	0.8858	22.50	5/32	181T-22.5	181A-22.5	181N-22.5
	57/64	0.8906	20.62	5/32	181T-.890	181A-.890	181N-.890
	-	0.9055	23.00	5/32	181T-23	181A-23	181N-23
	29/32	0.9063	23.02	5/32	181T-0029	181A-0029	181N-0029
	59/64	0.9219	23.42	5/32	181T-.921	181A-.921	181N-.921
	-	0.9252	23.50	5/32	181T-23.5	181A-23.5	181N-23.5
	15/16	0.9375	23.81	5/32	181T-0030	181A-0030	181N-0030
-	0.9449	24.00	5/32	181T-24	181A-24	181N-24	

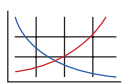
NOTE: 1.5 series inserts fit into both 1 and 1.5 series holders. However, 1 series inserts ONLY fit into 1 series holders. See page A30: 7 for visual.

A30: 112 - 143 

A30: 52 - 56 

A30: 4 - 6  HI, HR, CR, TC, SK, NP, IN, RN, CN, AN, BR, CI, CP, NC, WC

Coatings not listed above can be supplied as non-stocked standards. Process fees apply. →

TiN = 131T-XXXX	TiAlN = 131A-XXXX
TiCN = 131N-XXXX	AM200® = 131H-XXXX



Inserts sold in quantities of 2

Original T-A Drill Inserts

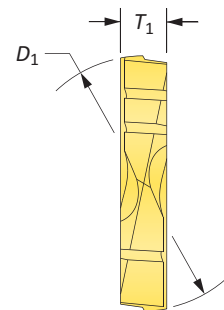
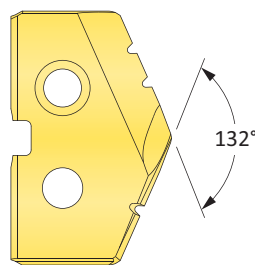
1 Series | HSS | Diameter Range: 0.690" - 0.960" (17.53mm - 24.38mm)



HSS Inserts – Super Cobalt

Series	Insert				Part No.		
	Fractional Equivalent	D_1 inch	D_1 mm	T_1	 TiN	 TiAlN	 TiCN
1	45/64	0.7031	17.86	5/32	151T-.703	151A-.703	151N-.703
	-	0.7087	18.00	5/32	151T-18	151A-18	151N-18
	23/32	0.7188	18.26	5/32	151T-0023	151A-0023	151N-0023
	-	0.7283	18.50	5/32	151T-18.5	151A-18.5	151N-18.5
	47/64	0.7344	18.65	5/32	151T-.734	151A-.734	151N-.734
	-	0.7480	19.00	5/32	151T-19	151A-19	151N-19
	3/4	0.7500	19.05	5/32	151T-0024	151A-0024	151N-0024
	49/64	0.7656	19.45	5/32	151T-.765	151A-.765	151N-.765
	-	0.7677	19.50	5/32	151T-19.5	151A-19.5	151N-19.5
	25/32	0.7813	19.84	5/32	151T-0025	151A-0025	151N-0025
	-	0.7874	20.00	5/32	151T-20	151A-20	151N-20
	51/64	0.7969	20.24	5/32	151T-.796	151A-.796	151N-.796
	-	0.8010	20.34	5/32	151T-.801	151A-.801	151N-.801
	-	0.8071	20.50	5/32	151T-20.5	151A-20.5	151N-20.5
	13/16	0.8125	20.64	5/32	151T-0026	151A-0026	151N-0026
	-	0.8268	21.00	5/32	151T-21	151A-21	151N-21
27/32	0.8438	21.43	5/32	151T-0027	151A-0027	151N-0027	
-	0.8465	21.50	5/32	151T-21.5	151A-21.5	151N-21.5	
1.5	55/64	0.8594	21.83	5/32	151T-.859	151A-.859	151N-.859
	-	0.8661	22.00	5/32	151T-22	151A-22	151N-22
	7/8	0.8750	22.23	5/32	151T-0028	151A-0028	151N-0028
	-	0.8858	22.50	5/32	151T-22.5	151A-22.5	151N-22.5
	57/64	0.8906	20.62	5/32	151T-.890	151A-.890	151N-.890
	-	0.9055	23.00	5/32	151T-23	151A-23	151N-23
	29/32	0.9063	23.02	5/32	151T-0029	151A-0029	151N-0029
	59/64	0.9219	23.42	5/32	151T-.921	151A-.921	151N-.921
	-	0.9252	23.50	5/32	151T-23.5	151A-23.5	151N-23.5
15/16	0.9375	23.81	5/32	151T-0030	151A-0030	151N-0030	
-	0.9449	24.00	5/32	151T-24	151A-24	151N-24	

NOTE: 1.5 series inserts fit into both 1 and 1.5 series holders. However, 1 series inserts ONLY fit into 1 series holders. See page A30: 7 for visual.

Inserts sold in quantities of 2

A30: 112 - 143

A30: 52 - 56

A30: 4 - 6

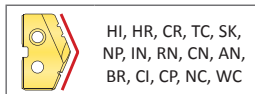
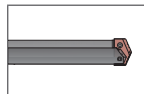
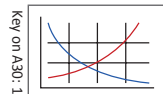

Coatings not listed above can be supplied as non-stocked standards. Process fees apply. →

TiN = 131T-XXXX	TiAlN = 131A-XXXX
TiCN = 131N-XXXX	AM200® = 131H-XXXX

Original T-A Drill Inserts

1 Series | HSS | Diameter Range: 0.690" - 0.960" (17.53mm - 24.38mm)



90° Spot & Chamfer

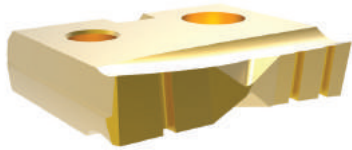

Flat Bottom

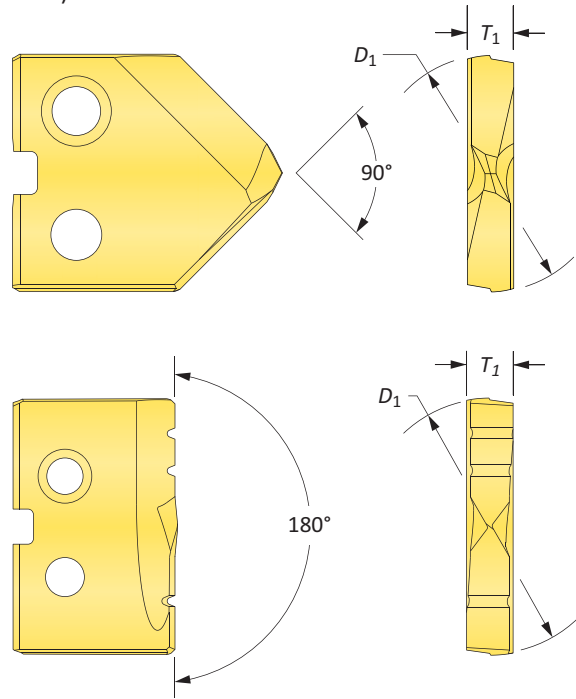

HSS Inserts – Super Cobalt

Series	Insert				90° Spot & Chamfer Part No.			Flat Bottom Part No.
	Fractional Equivalent	D ₁ inch	D ₁ mm	T ₁	TiN	TiAlN	TiCN	TiN
1	45/64	0.7031	17.86	5/32	151T-.703-SP	151A-.703-SP	151N-.703-SP	151T-.703-FB
	-	0.7087	18.00	5/32	151T-18-SP	151A-18-SP	151N-18-SP	151T-18-FB
	23/32	0.7188	18.26	5/32	151T-0023-SP	151A-0023-SP	151N-0023-SP	151T-0023-FB
	-	0.7283	18.50	5/32	151T-18.5-SP	151A-18.5-SP	151N-18.5-SP	151T-18.5-FB
	47/64	0.7344	18.65	5/32	151T-.734-SP	151A-.734-SP	151N-.734-SP	151T-.734-FB
	-	0.7480	19.00	5/32	151T-19-SP	151A-19-SP	151N-19-SP	151T-19-FB
	3/4	0.7500	19.05	5/32	151T-0024-SP	151A-0024-SP	151N-0024-SP	151T-0024-FB
	49/64	0.7656	19.45	5/32	151T-.765-SP	151A-.765-SP	151N-.765-SP	151T-.765-FB
	-	0.7677	19.50	5/32	151T-19.5-SP	151A-19.5-SP	151N-19.5-SP	151T-19.5-FB
	25/32	0.7813	19.84	5/32	151T-0025-SP	151A-0025-SP	151N-0025-SP	151T-0025-FB
	-	0.7874	20.00	5/32	151T-20-SP	151A-20-SP	151N-20-SP	151T-20-FB
	51/64	0.7969	20.24	5/32	151T-.796-SP	151A-.796-SP	151N-.796-SP	151T-.796-FB
	-	0.8010	20.34	5/32	151T-.801-SP	151A-.801-SP	151N-.801-SP	151T-.801-FB
	-	0.8071	20.50	5/32	151T-20.5-SP	151A-20.5-SP	151N-20.5-SP	151T-20.5-FB
	13/16	0.8125	20.64	5/32	151T-0026-SP	151A-0026-SP	151N-0026-SP	151T-0026-FB
	-	0.8268	21.00	5/32	151T-21-SP	151A-21-SP	151N-21-SP	151T-21-FB
27/32	0.8438	21.43	5/32	151T-0027-SP	151A-0027-SP	151N-0027-SP	151T-0027-FB	
-	0.8465	21.50	5/32	151T-21.5-SP	151A-21.5-SP	151N-21.5-SP	151T-21.5-FB	
1.5	55/64	0.8594	21.83	5/32	151T-.859-SP	151A-.859-SP	151N-.859-SP	151T-.859-FB
	-	0.8661	22.00	5/32	151T-22-SP	151A-22-SP	151N-22-SP	151T-22-FB
	7/8	0.8750	22.23	5/32	151T-0028-SP	151A-0028-SP	151N-0028-SP	151T-0028-FB
	-	0.8858	22.50	5/32	151T-22.5-SP	151A-22.5-SP	151N-22.5-SP	151T-22.5-FB
	57/64	0.8906	20.62	5/32	151T-.890-SP	151A-.890-SP	151N-.890-SP	151T-.890-FB
	-	0.9055	23.00	5/32	151T-23-SP	151A-23-SP	151N-23-SP	151T-23-FB
	29/32	0.9063	23.02	5/32	151T-0029-SP	151A-0029-SP	151N-0029-SP	151T-0029-FB
	59/64	0.9219	23.42	5/32	151T-.921-SP	151A-.921-SP	151N-.921-SP	151T-.921-FB
	-	0.9252	23.50	5/32	151T-23.5-SP	151A-23.5-SP	151N-23.5-SP	151T-23.5-FB
	15/16	0.9375	23.81	5/32	151T-0030-SP	151A-0030-SP	151N-0030-SP	151T-0030-FB
-	0.9449	24.00	5/32	151T-24-SP	151A-24-SP	151N-24-SP	151T-24-FB	

NOTE: 1.5 series inserts fit into both 1 and 1.5 series holders. However, 1 series inserts ONLY fit into 1 series holders. See page A30: 7 for visual.

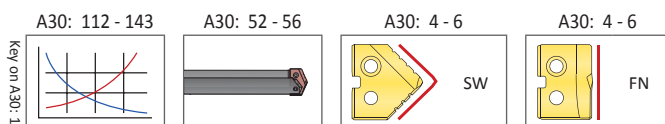

Coatings not listed above can be supplied as non-stocked standards. Process fees apply. →

TiN = 131T-XXXX	TiAlN = 131A-XXXX
TiCN = 131N-XXXX	AM200® = 131H-XXXX

Inserts sold in quantities of 2

A DRILLING
B BORING
C REAMING
D BURNISHING
E THREADING
X SPECIALS

Original T-A Drill Inserts

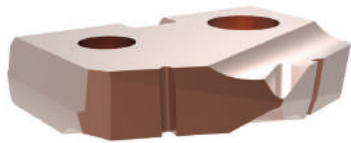

1 Series | HSS | Diameter Range: 0.690" - 0.960" (17.53mm - 24.38mm)

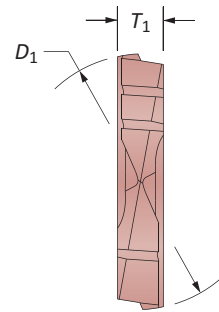
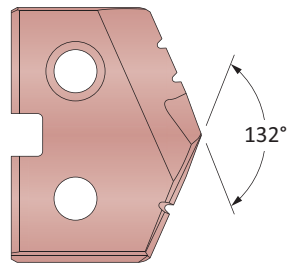

Tube Sheet



HSS Inserts – Super Cobalt | HSS

Series	Fractional Equivalent	Insert			Part No.	
		D_1 inch	D_1 mm	T_1	 Super Cobalt	 HSS
1	–	0.7580	19.25	5/32	151H-.7580-IN	131H-.7580-IN
	49/64	0.7656	19.45	5/32	151H-.765-IN	131H-.765-IN
	25/32	0.7813	19.85	5/32	151H-0025-IN	131H-0025-IN

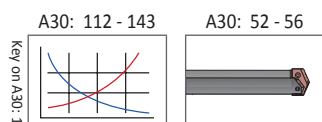

Coatings not listed above can be supplied as non-stocked standards. Process fees apply. →

TiN = 131T-XXXX	TiAlN = 131A-XXXX
TiCN = 131N-XXXX	AM200® = 131H-XXXX

Inserts sold in quantities of 2



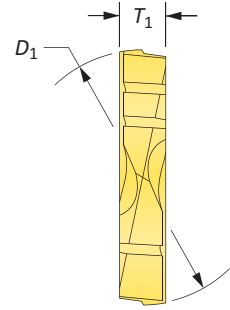
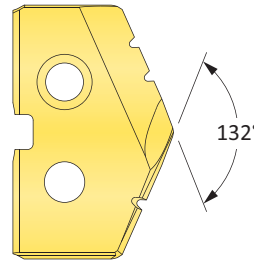
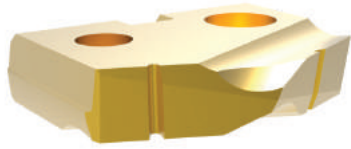

Original T-A Drill Inserts

1 Series | HSS | Diameter Range: 0.690" - 0.960" (17.53mm - 24.38mm)



HSS Inserts – HSS

Series	Fractional Equivalent	Insert			Part No.		
		D ₁ inch	D ₁ mm	T ₁	 TiN	 TiAlN	 TiCN
1	45/64	0.7031	17.86	5/32	131T-.703	131A-.703	131N-.703
	-	0.7087	18.00	5/32	131T-18	131A-18	131N-18
	23/32	0.7188	18.26	5/32	131T-0023	131A-0023	131N-0023
	-	0.7283	18.50	5/32	131T-18.5	131A-18.5	131N-18.5
	47/64	0.7344	18.65	5/32	131T-.734	131A-.734	131N-.734
	-	0.7480	19.00	5/32	131T-19	131A-19	131N-19
	3/4	0.7500	19.05	5/32	131T-0024	131A-0024	131N-0024
	49/64	0.7656	19.45	5/32	131T-.765	131A-.765	131N-.765
	-	0.7677	19.50	5/32	131T-19.5	131A-19.5	131N-19.5
	25/32	0.7813	19.84	5/32	131T-0025	131A-0025	131N-0025
	-	0.7874	20.00	5/32	131T-20	131A-20	131N-20
	51/64	0.7969	20.24	5/32	131T-.796	131A-.796	131N-.796
	-	0.8010	20.34	5/32	131T-.801	131A-.801	131N-.801
	-	0.8071	20.50	5/32	131T-20.5	131A-20.5	131N-20.5
	13/16	0.8125	20.64	5/32	131T-0026	131A-0026	131N-0026
-	0.8268	21.00	5/32	131T-21	131A-21	131N-21	
27/32	0.8438	21.43	5/32	131T-0027	131A-0027	131N-0027	
-	0.8465	21.50	5/32	131T-21.5	131A-21.5	131N-21.5	
1.5	55/64	0.8594	21.83	5/32	131T-.859	131A-.859	131N-.859
	-	0.8661	22.00	5/32	131T-22	131A-22	131N-22
	7/8	0.8750	22.23	5/32	131T-0028	131A-0028	131N-0028
	-	0.8858	22.50	5/32	131T-22.5	131A-22.5	131N-22.5
	57/64	0.8906	20.62	5/32	131T-.890	131A-.890	131N-.890
	-	0.9055	23.00	5/32	131T-23	131A-23	131N-23
	29/32	0.9063	23.02	5/32	131T-0029	131A-0029	131N-0029
	59/64	0.9219	23.42	5/32	131T-.921	131A-.921	131N-.921
	-	0.9252	23.50	5/32	131T-23.5	131A-23.5	131N-23.5
	15/16	0.9375	23.81	5/32	131T-0030	131A-0030	131N-0030
-	0.9449	24.00	5/32	131T-24	131A-24	131N-24	

NOTE: 1.5 series inserts fit into both 1 and 1.5 series holders. However, 1 series inserts ONLY fit into 1 series holders. See page A30: 7 for visual.

A30: 112 - 143

A30: 52 - 56

A30: 4 - 6

HI, HR, CR, TC, SK, NP, IN, RN, CN, AN, BR, CI, CP, NC, WC

Coatings not listed above can be supplied as non-stocked standards. Process fees apply. →

Inserts sold in quantities of 2

TiN = 131T-XXXX	TiAlN = 131A-XXXX
TiCN = 131N-XXXX	AM200® = 131H-XXXX

Original T-A Drill Inserts

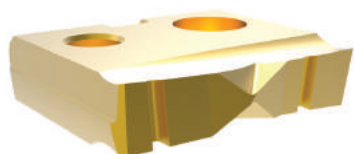

1 Series | Carbide | Diameter Range: 0.690" - 0.960" (17.53mm - 24.38mm)

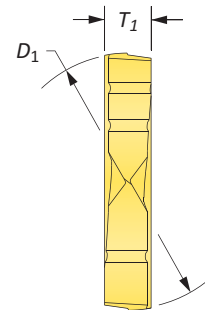
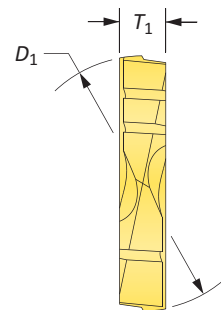
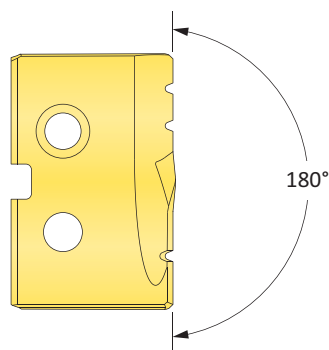
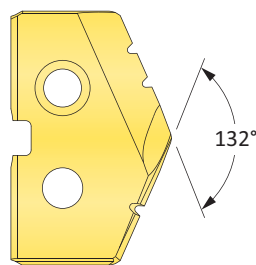

Flat Bottom



Carbide Inserts – C2 (K20)

Series	Insert				Part No.		Flat Bottom Part No.
	Fractional Equivalent	D ₁ inch	D ₁ mm	T ₁	 TiN	 TiAlN	 TiN
1	45/64	0.7031	17.86	5/32	1C21T-.703	1C21A-.703	1C21T-.703-FB
	-	0.7087	18.00	5/32	1C21T-18	1C21A-18	1C21T-18-FB
	23/32	0.7188	18.26	5/32	1C21T-0023	1C21A-0023	1C21T-0023-FB
	-	0.7283	18.50	5/32	1C21T-18.5	1C21A-18.5	1C21T-18.5-FB
	47/64	0.7344	18.65	5/32	1C21T-.734	1C21A-.734	1C21T-.734-FB
	-	0.7480	19.00	5/32	1C21T-19	1C21A-19	1C21T-19-FB
	3/4	0.7500	19.05	5/32	1C21T-0024	1C21A-0024	1C21T-0024-FB
	49/64	0.7656	19.45	5/32	1C21T-.765	1C21A-.765	1C21T-.765-FB
	-	0.7677	19.50	5/32	1C21T-19.5	1C21A-19.5	1C21T-19.5-FB
	25/32	0.7813	19.84	5/32	1C21T-0025	1C21A-0025	1C21T-0025-FB
	-	0.7874	20.00	5/32	1C21T-20	1C21A-20	1C21T-20-FB
	51/64	0.7969	20.24	5/32	1C21T-.796	1C21A-.796	1C21T-.796-FB
	-	0.8010	20.34	5/32	1C21T-.801	1C21A-.801	1C21T-.801-FB
	-	0.8071	20.50	5/32	1C21T-20.5	1C21A-20.5	1C21T-20.5-FB
	13/16	0.8125	20.64	5/32	1C21T-0026	1C21A-0026	1C21T-0026-FB
	-	0.8268	21.00	5/32	1C21T-21	1C21A-21	1C21T-21-FB
	27/32	0.8438	21.43	5/32	1C21T-0027	1C21A-0027	1C21T-0027-FB
-	0.8465	21.50	5/32	1C21T-21.5	1C21A-21.5	1C21T-21.5-FB	
1.5	55/64	0.8594	21.83	5/32	1C21T-.859	1C21A-.859	1C21T-.859-FB
	-	0.8661	22.00	5/32	1C21T-22	1C21A-22	1C21T-22-FB
	7/8	0.8750	22.23	5/32	1C21T-0028	1C21A-0028	1C21T-0028-FB
	-	0.8858	22.50	5/32	1C21T-22.5	1C21A-22.5	1C21T-22.5-FB
	57/64	0.8906	20.62	5/32	1C21T-.890	1C21A-.890	1C21T-.890-FB
	-	0.9055	23.00	5/32	1C21T-23	1C21A-23	1C21T-23-FB
	29/32	0.9063	23.02	5/32	1C21T-0029	1C21A-0029	1C21T-0029-FB
	59/64	0.9219	23.42	5/32	1C21T-.921	1C21A-.921	1C21T-.921-FB
	-	0.9252	23.50	5/32	1C21T-23.5	1C21A-23.5	1C21T-23.5-FB
	15/16	0.9375	23.81	5/32	1C21T-0030	1C21A-0030	1C21T-0030-FB
-	0.9449	24.00	5/32	1C21T-24	1C21A-24	1C21T-24-FB	

NOTE: 1.5 series inserts fit into both 1 and 1.5 series holders. However, 1 series inserts ONLY fit into 1 series holders. See page A30: 7 for visual.

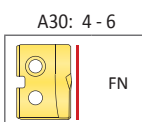
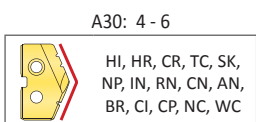
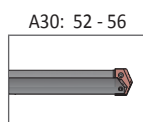
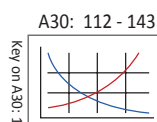

Coatings not listed above can be supplied as non-stocked standards. Process fees apply. →

TiN = 131T-XXXX	TiAlN = 131A-XXXX
TiCN = 131N-XXXX	AM200® = 131H-XXXX

Inserts sold in quantities of 2



Original T-A Drill Inserts

1 Series | Carbide | Diameter Range: 0.690" - 0.960" (17.53mm - 24.38mm)

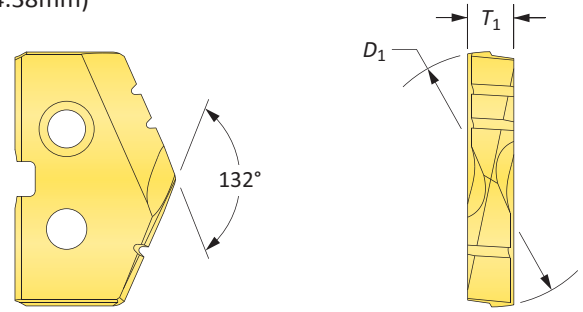

Carbide Inserts – C5 (P40) | C3 (K10) | N2

Series	Insert				C5 Part No.		C3 Part No.	N2 Part No.
	Fractional Equivalent	D ₁ inch	D ₁ mm	T ₁	TiN	TiAlN	TiAlN (Cast Iron)	Diamond Film
1	45/64	0.7031	17.86	5/32	1C51T-.703	1C51A-.703	1C31A-.703-CI	1N21D-.703
	-	0.7087	18.00	5/32	1C51T-18	1C51A-18	1C31A-18-CI	1N21D-18
	23/32	0.7188	18.26	5/32	1C51T-0023	1C51A-0023	1C31A-0023-CI	1N21D-0023
	-	0.7283	18.50	5/32	1C51T-18.5	1C51A-18.5	1C31A-18.5-CI	1N21D-18.5
	47/64	0.7344	18.65	5/32	1C51T-.734	1C51A-.734	1C31A-.734-CI	1N21D-.734
	-	0.7480	19.00	5/32	1C51T-19	1C51A-19	1C31A-19-CI	1N21D-19
	3/4	0.7500	19.05	5/32	1C51T-0024	1C51A-0024	1C31A-0024-CI	1N21D-0024
	49/64	0.7656	19.45	5/32	1C51T-.765	1C51A-.765	1C31A-.765-CI	1N21D-.765
	-	0.7677	19.50	5/32	1C51T-19.5	1C51A-19.5	1C31A-19.5-CI	1N21D-19.5
	25/32	0.7813	19.84	5/32	1C51T-0025	1C51A-0025	1C31A-0025-CI	1N21D-0025
	-	0.7874	20.00	5/32	1C51T-20	1C51A-20	1C31A-20-CI	1N21D-20
	51/64	0.7969	20.24	5/32	1C51T-.796	1C51A-.796	1C31A-.796-CI	1N21D-.796
	-	0.8010	20.34	5/32	1C51T-.801	1C51A-.801	1C31A-.801-CI	1N21D-.801
	-	0.8071	20.50	5/32	1C51T-20.5	1C51A-20.5	1C31A-20.5-CI	1N21D-20.5
	13/16	0.8125	20.64	5/32	1C51T-0026	1C51A-0026	1C31A-0026-CI	1N21D-0026
	-	0.8268	21.00	5/32	1C51T-21	1C51A-21	1C31A-21-CI	1N21D-21
27/32	0.8438	21.43	5/32	1C51T-0027	1C51A-0027	1C31A-0027-CI	1N21D-0027	
-	0.8465	21.50	5/32	1C51T-21.5	1C51A-21.5	1C31A-21.5-CI	1N21D-21.5	
1.5	55/64	0.8594	21.83	5/32	1C51T-.859	1C51A-.859	1C31A-.859-CI	1N21D-.859
	-	0.8661	22.00	5/32	1C51T-22	1C51A-22	1C31A-22-CI	1N21D-22
	7/8	0.8750	22.23	5/32	1C51T-0028	1C51A-0028	1C31A-0028-CI	1N21D-0028
	-	0.8858	22.50	5/32	1C51T-22.5	1C51A-22.5	1C31A-22.5-CI	1N21D-22.5
	57/64	0.8906	20.62	5/32	1C51T-.890	1C51A-.890	1C31A-.890-CI	1N21D-.890
	-	0.9055	23.00	5/32	1C51T-23	1C51A-23	1C31A-23-CI	1N21D-23
	29/32	0.9063	23.02	5/32	1C51T-0029	1C51A-0029	1C31A-0029-CI	1N21D-0029
	59/64	0.9219	23.42	5/32	1C51T-.921	1C51A-.921	1C31A-.921-CI	1N21D-.921
	-	0.9252	23.50	5/32	1C51T-23.5	1C51A-23.5	1C31A-23.5-CI	1N21D-23.5
	15/16	0.9375	23.81	5/32	1C51T-0030	1C51A-0030	1C31A-0030-CI	1N21D-0030
-	0.9449	24.00	5/32	1C51T-24	1C51A-24	1C31A-24-CI	1N21D-24	

NOTE: 1.5 series inserts fit into both 1 and 1.5 series holders. However, 1 series inserts ONLY fit into 1 series holders. See page A30: 7 for visual.

A30: 112 - 143

A30: 52 - 56

A30: 4 - 6

HI, HR, CR, TC, SK, NP, IN, RN, CN, AN, BR, CI, CP, NC, WC

Coatings not listed above can be supplied as non-stocked standards. Process fees apply. →

TiN = 131T-XXXX	TiAlN = 131A-XXXX
TiCN = 131N-XXXX	AM200® = 131H-XXXX

Inserts sold in quantities of 2

T-A Drill Insert Holders

1 Series | Flange Shank

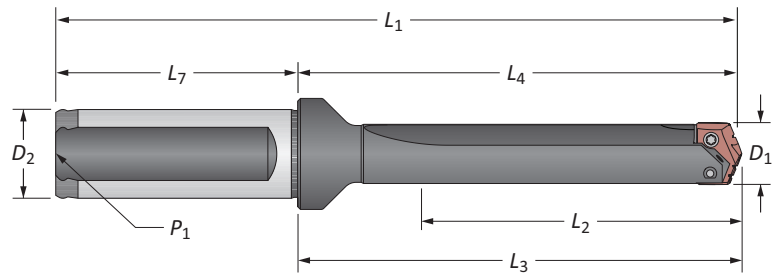

Stub Length

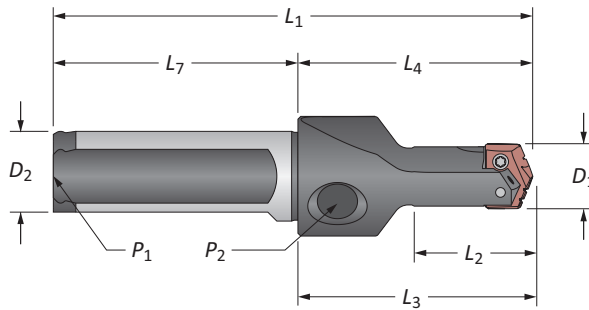

Straight Flute

Series	Length	D_1	Body				Shank			Part No.	
			L_2	L_4	L_3	L_1	D_2	L_7	P_1		
1	Stub	45/64 - 15/16	1-7/8	2-63/64	3-1/8	5-17/64	1	2-9/32	1/8	21010S-100F	
	Short	45/64 - 15/16	2-5/8	4-7/32	4-23/64	6-1/2	1	2-9/32	1/8	22010S-100F	
	Intermediate	45/64 - 15/16	4-5/8	6-3/32	6-15/64	8-3/8	1	2-9/32	1/8	23010S-100F	
	Standard	45/64 - 15/16	6-5/8	8-3/32	8-15/64	10-3/8	1	2-9/32	1/8	24010S-100F	
	Extended	45/64 - 15/16	10-5/8	12-3/32	12-15/64	14-3/8	1	2-9/32	1/8	25010S-100F	
1.5	Stub	55/64 - 15/16	2-1/4	3-31/64	3-5/8	5-49/64	1	2-9/32	1/8	21015S-100F	
	Short	55/64 - 15/16	2-5/8	4-7/32	4-23/64	6-1/2	1	2-9/32	1/8	22015S-100F	
	Intermediate	55/64 - 15/16	4-5/8	6-3/32	6-15/64	8-3/8	1	2-9/32	1/8	23015S-100F	
	Standard	55/64 - 15/16	6-5/8	8-3/32	8-15/64	10-3/8	1	2-9/32	1/8	24015S-100F	
	Extended	55/64 - 15/16	10-5/8	12-3/32	12-15/64	14-3/8	1	2-9/32	1/8	25015S-100F	
m	1	Stub	18.0 - 24.0	47.6	75.8	79.4	131.8	25.0	56.0	1/8*	21010S-25FM
		Short	18.0 - 24.0	66.7	107.2	110.7	163.2	25.0	56.0	1/8*	22010S-25FM
		XL	18.0 - 24.0	457.0	494.5	498.1	550.5	25.0	56.0	1/8*	27010S-25FM
		3XL	18.0 - 24.0	569.0	602.5	606.1	658.5	25.0	56.0	1/8*	29010S-25FM
	1.5	Stub	22.0 - 24.0	57.2	88.5	92.1	144.5	25.0	56.0	1/8*	21015S-25FM
		Short	22.0 - 24.0	66.7	107.2	110.7	163.2	25.0	56.0	1/8*	22015S-25FM

*Metric thread to BSP and ISO 7-1

NOTE: Stub length holders have a 1/8" side pipe tap (P_2)

Connection Accessories

Series	Insert Screws	Nylon Locking Screws	Insert Driver	Preset Torque Hand Driver	Replacement Tips	Admissible Tightening Torque*
1	7375-IP9-1	7375N-IP9-1	8IP-9	8IP-9TL	8IP-9B	27.0 in-lbs (305 N-cm)
1.5	739-IP9-1	739N-IP9-1	8IP-9	8IP-9TL	8IP-9B	27.0 in-lbs (305 N-cm)

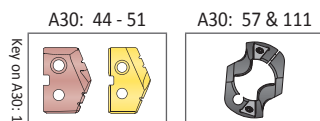
*Tightening torques are calculated with a friction coefficient of $\mu = 0.14$ and develop 90% of ultimate yield strength

Key on A30: 1

i = Imperial (in)

m = Metric (mm)

Screws sold in quantities of 10

WARNING Refer to Speed and Feed charts for recommended adjustments to speeds and feeds. Refer to page A30: 146 for deep hole drilling guidelines in this section of the catalog. Visit www.alliedmachine.com/DeepHoleGuidelines for the most up-to-date information and procedures. Factory technical assistance is available for your specific applications through our Application Engineering Team.

T-A Drill Insert Holders

1 Series | Flange Shank

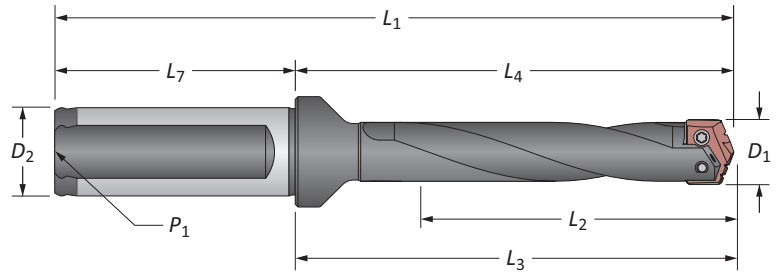

Helical Flute

Series	Length	D ₁	Body				Shank			Part No.
			L ₂	L ₄	L ₃	L ₁	D ₂	L ₇	P ₁	
i	Intermediate	45/64 - 15/16	4-5/8	6-3/32	6-15/64	8-3/8	1	2-9/32	1/8	23010H-100F
	Standard	45/64 - 15/16	6-5/8	8-3/32	8-15/64	10-3/8	1	2-9/32	1/8	24010H-100F
	Standard Plus	45/64 - 15/16	8-5/8	10-3/32	10-15/64	12-33/64	1	2-9/32	1/8	⚠ 24510H-100F
	Extended	45/64 - 15/16	10-5/8	12-3/32	12-15/64	14-3/8	1	2-9/32	1/8	⚠ 25010H-100F
	Long	45/64 - 15/16	14-3/8	15-27/32	15-63/64	18-17/64	1	2-9/32	1/8	⚠ 26010H-100F
1.5	Intermediate	55/64 - 15/16	4-5/8	6-3/32	6-15/64	8-3/8	1	2-9/32	1/8	23015H-100F
	Standard	55/64 - 15/16	6-5/8	8-3/32	8-15/64	10-3/8	1	2-9/32	1/8	24015H-100F
	Extended	55/64 - 15/16	10-5/8	12-3/32	12-15/64	14-3/8	1	2-9/32	1/8	⚠ 25015H-100F
ii	Intermediate	18.0 - 24.0	117.5	154.8	158.4	210.8	25.0	56.0	1/8*	23010H-25FM
	Standard	18.0 - 24.0	168.3	205.6	209.2	261.6	25.0	56.0	1/8*	24010H-25FM
	Standard Plus	18.0 - 24.0	219.0	256.3	259.9	312.3	25.0	56.0	1/8*	⚠ 24510H-25FM
	Extended	18.0 - 24.0	269.9	307.2	310.8	363.2	25.0	56.0	1/8*	⚠ 25010H-25FM
	Long	18.0 - 24.0	365.0	402.3	405.9	458.3	25.0	56.0	1/8*	⚠ 26010H-25FM
	1.5	Intermediate	22.0 - 24.0	117.5	154.8	158.4	210.8	25.0	56.0	1/8*
Standard	22.0 - 24.0	168.3	205.6	209.2	261.6	25.0	56.0	1/8*	24015H-25FM	
Extended	22.0 - 24.0	269.9	307.2	310.8	363.2	25.0	56.0	1/8*	⚠ 25015H-25FM	

*Metric thread to BSP and ISO 7-1

Connection Accessories

Series	Insert Screws	Nylon Locking Screws	Insert Driver	Preset Torque Hand Driver	Replacement Tips	Admissible Tightening Torque*
1	7375-IP9-1	7375N-IP9-1	8IP-9	8IP-9TL	8IP-9B	27.0 in-lbs (305 N-cm)
1.5	739-IP9-1	739N-IP9-1	8IP-9	8IP-9TL	8IP-9B	27.0 in-lbs (305 N-cm)

*Tightening torques are calculated with a friction coefficient of $\mu = 0.14$ and develop 90% of ultimate yield strength

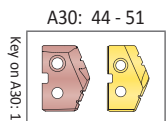

i = Imperial (in)
m = Metric (mm)

Screws sold in quantities of 10

⚠ WARNING Refer to Speed and Feed charts for recommended adjustments to speeds and feeds. Refer to page A30: 146 for deep hole drilling guidelines in this section of the catalog. Visit www.alliedmachine.com/DeepHoleGuidelines for the most up-to-date information and procedures. Factory technical assistance is available for your specific applications through our Application Engineering Team.

T-A Drill Insert Holders

1 Series | Taper Shank

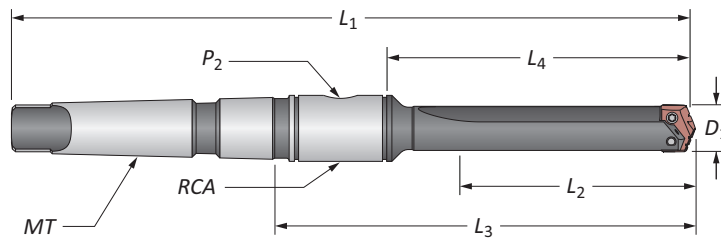

Straight Flute

Series	Length	D ₁	Body				Shank			Part No.	
			L ₂	L ₃	L ₄	L ₁	MT	P ₂	RCA		
1	Short	45/64 - 15/16	2-3/4	3-7/8	5-39/64	9-5/32	#3	1/8	2T-3SR	22010S-003I	
	Short	45/64 - 15/16	2-3/4	3-7/8	5-39/64	10-5/32	#4	1/8	2T-3SR	22010S-004I	
	Intermediate	45/64 - 15/16	4-3/4	5-7/8	7-39/64	11-5/32	#3	1/8	2T-3SR	23010S-003I	
	Standard	45/64 - 15/16	6-3/4	7-7/8	9-39/64	13-5/32	#3	1/8	2T-3SR	24010S-003I	
	Standard	45/64 - 15/16	6-3/4	7-7/8	9-39/64	14-5/32	#4	1/8	2T-3SR	24010S-004I	
1.5	Extended	45/64 - 15/16	10-3/4	11-7/8	13-39/64	17-5/32	#3	1/8	2T-3SR	25010S-003I	
	Short	55/64 - 15/16	2-3/4	3-7/8	5-39/64	9-5/32	#3	1/8	2T-3SR	22015S-003I	
	Short	55/64 - 15/16	2-3/4	3-7/8	5-39/64	10-5/32	#4	1/8	2T-3SR	22015S-004I	
	Intermediate	55/64 - 15/16	4-3/4	5-7/8	7-39/64	11-5/32	#3	1/8	2T-3SR	23015S-003I	
	Standard	55/64 - 15/16	6-3/4	7-7/8	9-39/64	13-5/32	#3	1/8	2T-3SR	24015S-003I	
1.5	Standard	55/64 - 15/16	6-3/4	7-7/8	9-39/64	14-5/32	#4	1/8	2T-3SR	24015S-004I	
	Extended	55/64 - 15/16	10-3/4	11-7/8	13-39/64	17-5/32	#3	1/8	2T-3SR	25015S-003I	
M	1	Short	18.0 - 24.0	69.8	98.4	142.5	232.5	#3**	1/8*	2T-3SRM	22010S-003M
	1.5	Short	22.0 - 24.0	69.8	98.4	142.5	232.5	#3**	1/8*	2T-3SRM	22015S-003M

*Metric thread to BSP and ISO 7-1

**Per ISO 296 type BEK

Connection Accessories

Series	Insert Screws	Nylon Locking Screws	Insert Driver	Preset Torque Hand Driver	Replacement Tips	Admissible Tightening Torque*
1	7375-IP9-1	7375N-IP9-1	8IP-9	8IP-9TL	8IP-9B	27.0 in-lbs (305 N-cm)
1.5	739-IP9-1	739N-IP9-1	8IP-9	8IP-9TL	8IP-9B	27.0 in-lbs (305 N-cm)

*Tightening torques are calculated with a friction coefficient of $\mu = 0.14$ and develop 90% of ultimate yield strength

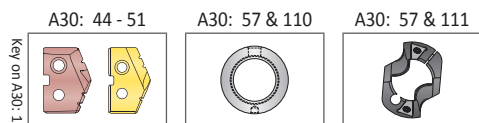

I = Imperial (in)

M = Metric (mm)

Screws sold in quantities of 10



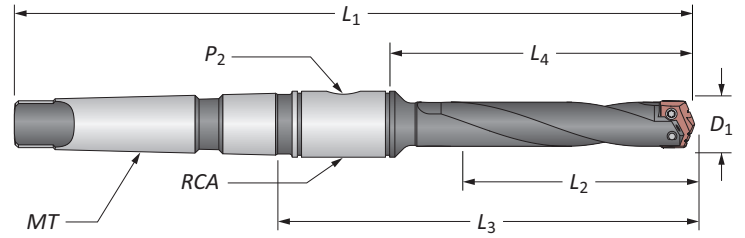

WARNING Refer to Speed and Feed charts for recommended adjustments to speeds and feeds. Refer to page A30: 146 for deep hole drilling guidelines in this section of the catalog. Visit www.alliedmachine.com/DeepHoleGuidelines for the most up-to-date information and procedures. Factory technical assistance is available for your specific applications through our Application Engineering Team.

T-A Drill Insert Holders

1 Series | Taper Shank







Helical Flute

Series	Length	D ₁	Body				Shank			Part No.	
			L ₂	L ₃	L ₄	L ₁	MT	P ₂	RCA		
i	1	Intermediate	45/64 - 15/16	4-3/4	5-7/8	7-39/64	11-5/32	#3	1/8	2T-3SR	23010H-003I
		Standard	45/64 - 15/16	6-3/4	7-7/8	9-39/64	13-5/32	#3	1/8	2T-3SR	24010H-003I
		Standard	45/64 - 15/16	6-3/4	7-7/8	9-43/64	14-5/32	#4	1/8	2T-3SR	24010H-004I
	1.5	Extended	45/64 - 15/16	10-3/4	11-7/8	13-39/64	17-5/32	#3	1/8	2T-3SR	 25010H-003I
		Intermediate	55/64 - 15/16	4-3/4	5-7/8	7-39/64	11-5/32	#3	1/8	2T-3SR	23015H-003I
		Standard	55/64 - 15/16	6-3/4	7-7/8	9-39/64	13-5/32	#3	1/8	2T-3SR	24015H-003I
		Standard	55/64 - 15/16	6-3/4	7-7/8	9-43/64	14-5/32	#4	1/8	2T-3SR	24015H-004I
m	1	Extended	55/64 - 15/16	10-3/4	11-7/8	13-39/64	17-5/32	#3	1/8	2T-3SR	 25015H-003I
		Intermediate	18.0 - 24.0	120.7	149.2	193.3	283.3	#3**	1/8*	2T-3SRM	23010H-003M
		Standard	18.0 - 24.0	171.5	200.0	244.1	334.2	#3**	1/8*	2T-3SRM	24010H-003M
	1.5	Extended	18.0 - 24.0	273.1	301.6	345.7	435.8	#3**	1/8*	2T-3SRM	 25010H-003M
		Intermediate	22.0 - 24.0	120.7	149.2	193.3	283.3	#3**	1/8*	2T-3SRM	23015H-003M
		Standard	22.0 - 24.0	171.5	200.0	244.1	334.2	#3**	1/8*	2T-3SRM	24015H-003M
Standard	22.0 - 24.0	273.1	301.6	345.7	435.8	#3**	1/8*	2T-3SRM	 25015H-003M		

*Metric thread to BSP and ISO 7-1

**Per ISO 296 type BEK

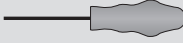
Connection Accessories

Series	 Insert Screws	 Nylon Locking Screws	 Insert Driver	 Preset Torque Hand Driver	 Replacement Tips	Admissible Tightening Torque*
1	7375-IP9-1	7375N-IP9-1	8IP-9	8IP-9TL	8IP-9B	27.0 in-lbs (305 N-cm)
1.5	739-IP9-1	739N-IP9-1	8IP-9	8IP-9TL	8IP-9B	27.0 in-lbs (305 N-cm)

*Tightening torques are calculated with a friction coefficient of $\mu = 0.14$ and develop 90% of ultimate yield strength

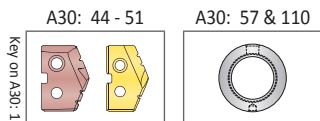

i = Imperial (in)

m = Metric (mm)

Screws sold in quantities of 10

 **WARNING** Refer to Speed and Feed charts for recommended adjustments to speeds and feeds. Refer to page A30: 146 for deep hole drilling guidelines in this section of the catalog. Visit www.alliedmachine.com/DeepHoleGuidelines for the most up-to-date information and procedures. Factory technical assistance is available for your specific applications through our Application Engineering Team.

T-A Drill Insert Holders

1 Series | Straight Shank

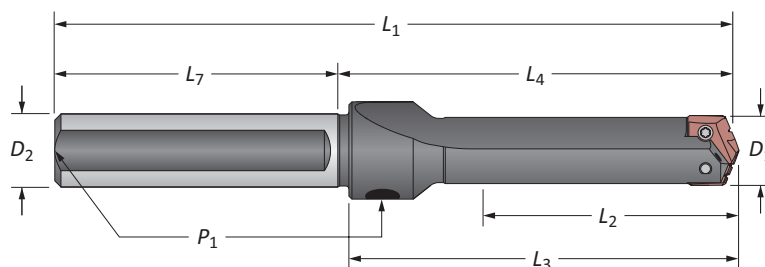

Straight Flute

Series	Length	D ₁	Body				Shank			Part No.
			L ₂	L ₄	L ₃	L ₁	D ₂	L ₇	P ₁	
1	Short	45/64 - 15/16	2-5/8	3-7/8	4-1/64	6-7/8	3/4	3	1/8	22010S-075L
	Short	45/64 - 15/16	2-5/8	3-7/8	4-1/64	6-7/8	1	3	1/8	22010S-100L
	Intermediate	45/64 - 15/16	4-5/8	5-7/8	6-1/64	8-7/8	1	3	1/8	23010S-100L
	Standard	45/64 - 15/16	6-5/8	7-7/8	8-1/64	10-7/8	3/4	3	1/8	24010S-075L
	Standard	45/64 - 15/16	6-5/8	7-7/8	8-1/64	10-7/8	1	3	1/8	24010S-100L
	Extended	45/64 - 15/16	10-5/8	11-7/8	12-1/64	14-7/8	1	3	1/8	⚠ 25010S-100L
	XL	45/64 - 15/16	18	19-1/4	19-25/64	22-1/4	1	3	1/8	⚠ 27010S-100L
1.5	3XL	45/64 - 15/16	22-1/4	23-1/2	23-41/64	26-1/2	1	3	1/8	⚠ 29010S-100L
	Short	55/64 - 15/16	2-5/8	3-7/8	4-1/64	6-7/8	3/4	3	1/8*	22015S-075L
	Short	55/64 - 15/16	2-5/8	3-7/8	4-1/64	6-7/8	1	3	1/8*	22015S-100L
	Intermediate	55/64 - 15/16	4-5/8	5-7/8	6-1/64	8-7/8	1	3	1/8*	23015S-100L
	Standard	55/64 - 15/16	6-5/8	7-7/8	8-1/64	10-7/8	3/4	3	1/8*	24015S-075L
	Standard	55/64 - 15/16	6-5/8	7-7/8	8-1/64	10-7/8	1	3	1/8*	24015S-100L
	Extended	55/64 - 15/16	10-5/8	11-7/8	12-1/64	14-7/8	1	3	1/8*	⚠ 25015S-100L

Connection Accessories

Series	Insert Screws	Nylon Locking Screws	Insert Driver	Preset Torque Hand Driver	Replacement Tips	Admissible Tightening Torque*
1	7375-IP9-1	7375N-IP9-1	8IP-9	8IP-9TL	8IP-9B	27.0 in-lbs (305 N-cm)
1.5	739-IP9-1	739N-IP9-1	8IP-9	8IP-9TL	8IP-9B	27.0 in-lbs (305 N-cm)

*Tightening torques are calculated with a friction coefficient of $\mu = 0.14$ and develop 90% of ultimate yield strength

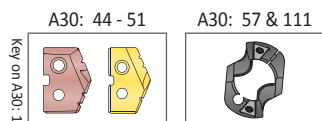

ⓘ = Imperial (in)
 ⓘ = Metric (mm)

Screws sold in quantities of 10

⚠ WARNING Refer to Speed and Feed charts for recommended adjustments to speeds and feeds. Refer to page A30: 146 for deep hole drilling guidelines in this section of the catalog. Visit www.alliedmachine.com/DeepHoleGuidelines for the most up-to-date information and procedures. Factory technical assistance is available for your specific applications through our Application Engineering Team.

T-A Drill Accessories

1 Series | Chamfer Rings | Rotary Coolant Adapters | Torx® Plus Screws

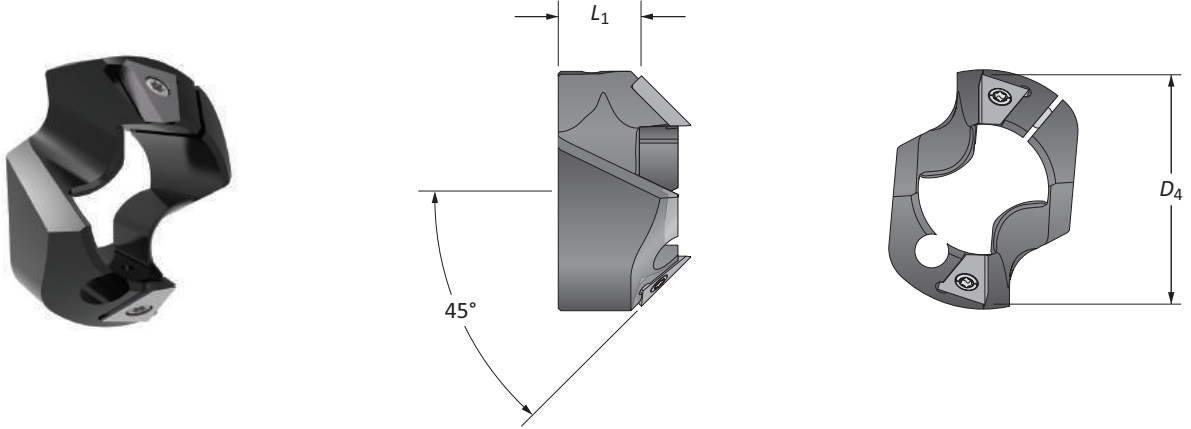

T-ACR 45 Chamfer Ring

Holder Series	D ₁ Range	Chamfer Ring		Part No.	Insert Part No.	Insert Screw	Insert Driver	Clamping Screw	Insert Driver
		D ₄	L ₁						
1	0.6900 - 0.8540	1-3/64	51/64	T-ACR-45-1	T-ACRI-45-B-C5A	7255-IP8-1	8IP-8	7495-IP15-1	8IP-15
1.5	0.8540 - 0.9600	1-1/8	57/64	T-ACR-45-1.5	T-ACRI-45-B-C5A	7255-IP8-1	8IP-8	7495-IP15-1	8IP-15

Rotary Coolant Adapter (RCA) and Accessories

ID	OD	L ₁	Driving Rod Thread	P ₁	Part No.	RCA O-Rings	
						Kit Part No.**	Replacements
1	2-1/8	1-1/8	5/16-18	1/8	2T-3SR	2T1-3SR	2T1-3OR-10
25.40	53.97	28.57	M8 x 1.25	1/8*	2T-3SRM	2T1-3SR	2T1-3OR-10

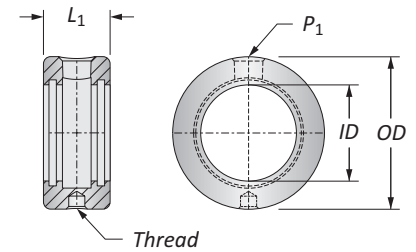

*Thread to BSP and ISO 7-1

**RCA Repair Kit includes (2) O-rings, (2) snap rings, and (2) thrust washers

▲ Refer to page A30: 110 for proper RCA assembly and safety information

Connection Accessories

Series	Insert Screws	Nylon Locking Screws	Insert Driver	Preset Torque Hand Driver	Replacement Tips	Admissible Tightening Torque*
1	7375-IP9-1	7375N-IP9-1	8IP-9	8IP-9TL	8IP-9B	27.0 in-lbs (305 N-cm)
1.5	739-IP9-1	739N-IP9-1	8IP-9	8IP-9TL	8IP-9B	27.0 in-lbs (305 N-cm)

*Tightening torques are calculated with a friction coefficient of $\mu = 0.14$ and develop 90% of ultimate yield strength

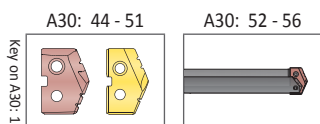

ⓘ = Imperial (in)
 Ⓜ = Metric (mm)

Chamfer Ring Inserts sold separately
 Screws sold in packs of 10
 O-rings sold in packs of 10

WARNING RCA rotation during drilling can cause hose and/or hose fitting failure, machinery damage, and/or serious injury. To prevent, use RCA and positive stop studs when drilling. Factory technical assistance is also available for your specific applications.

A DRILLING
 B BORING
 C REAMING
 D BURNISHING
 E THREADING
 X SPECIALS

GEN2 T-A Drill Inserts

2 Series | Diameter Range: 0.961" - 1.380" (24.41mm - 35.05mm)

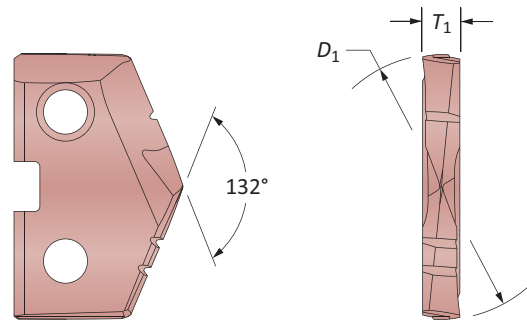

HSS Inserts – Super Cobalt • Carbide Inserts – C2 (K20) | C1 (K35)

Series	Fractional Equivalent	Insert			HSS Part No.	Carbide Part No.	
		D_1 inch	D_1 mm	T_1	Super Cobalt	C2	C1
2	-	0.9646	24.50	3/16	452H-24.5	4C22H-24.5	4C12H-24.5
	31/32	0.9688	24.61	3/16	452H-0031	4C22H-0031	4C12H-0031
	-	0.9760	24.79	3/16	452H-.976	4C22H-.976	4C12H-.976
	63/64	0.9843	25.00	3/16	452H-25	4C22H-25	4C12H-25
	1	1.0000	25.40	3/16	452H-0100	4C22H-0100	4C12H-0100
	-	1.0039	25.50	3/16	452H-25.5	4C22H-25.5	4C12H-25.5
	1-1/64	1.0156	25.80	3/16	452H-1.015	4C22H-1.015	4C12H-1.015
	-	1.0236	26.00	3/16	452H-26	4C22H-26	4C12H-26
	1-1/32	1.0313	26.19	3/16	452H-0101	4C22H-0101	4C12H-0101
	-	1.0433	26.50	3/16	452H-26.5	4C22H-26.5	4C12H-26.5
	1-3/64	1.0469	26.59	3/16	452H-1.046	4C22H-1.046	4C12H-1.046
	1-1/16	1.0625	26.99	3/16	452H-0102	4C22H-0102	4C12H-0102
	-	1.0630	27.00	3/16	452H-27	4C22H-27	4C12H-27
	-	1.0827	27.50	3/16	452H-27.5	4C22H-27.5	4C12H-27.5
	1-3/32	1.0938	27.78	3/16	452H-0103	4C22H-0103	4C12H-0103
	-	1.1024	28.00	3/16	452H-28	4C22H-28	4C12H-28
	1-7/64	1.1094	28.18	3/16	452H-1.109	4C22H-1.109	4C12H-1.109
	-	1.1220	28.50	3/16	452H-28.5	4C22H-28.5	4C12H-28.5
	1-1/8	1.1250	28.58	3/16	452H-0104	4C22H-0104	4C12H-0104
	-	1.1417	29.00	3/16	452H-29	4C22H-29	4C12H-29
1-5/32	1.1563	29.37	3/16	452H-0105	4C22H-0105	4C12H-0105	
-	1.1614	29.50	3/16	452H-29.5	4C22H-29.5	4C12H-29.5	
-	1.1811	30.00	3/16	452H-30	4C22H-30	4C12H-30	
2.5	1-3/16	1.1875	30.16	3/16	452H-0106	4C22H-0106	4C12H-0106
	-	1.2008	30.50	3/16	452H-30.5	4C22H-30.5	4C12H-30.5
	1-7/32	1.2188	30.96	3/16	452H-0107	4C22H-0107	4C12H-0107
	-	1.2205	31.00	3/16	452H-31	4C22H-31	4C12H-31
	-	1.2260	31.14	3/16	452H-1.226	4C22H-1.226	4C12H-1.226
	-	1.2310	31.26	3/16	452H-1.231	4C22H-1.231	4C12H-1.231
	-	1.2340	31.34	3/16	452H-1.234	4C22H-1.234	4C12H-1.234
	-	1.2402	31.50	3/16	452H-31.5	4C22H-31.5	4C12H-31.5
	1-1/4	1.2500	31.75	3/16	452H-0108	4C22H-0108	4C12H-0108
	-	1.2598	32.00	3/16	452H-32	4C22H-32	4C12H-32
	-	1.2795	32.50	3/16	452H-32.5	4C22H-32.5	4C12H-32.5
	1-9/32	1.2813	32.54	3/16	452H-0109	4C22H-0109	4C12H-0109
	-	1.2992	33.00	3/16	452H-33	4C22H-33	4C12H-33
	1-5/16	1.3125	33.34	3/16	452H-0110	4C22H-0110	4C12H-0110
	-	1.3189	33.50	3/16	452H-33.5	4C22H-33.5	4C12H-33.5
	-	1.3386	34.00	3/16	452H-34	4C22H-34	4C12H-34
	1-11/32	1.3438	34.13	3/16	452H-0111	4C22H-0111	4C12H-0111
	-	1.3582	34.50	3/16	452H-34.5	4C22H-34.5	4C12H-34.5
	1-3/8	1.3750	34.93	3/16	452H-0112	4C22H-0112	4C12H-0112
	-	1.3780	35.00	3/16	452H-35	4C22H-35	4C12H-35

NOTE: 2.5 series inserts fit into both 2 and 2.5 series holders. However, 2 series inserts ONLY fit into 2 series holders. See page A30: 7 for visual.

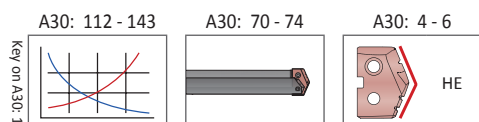

Coatings not listed above can be supplied as non-stocked standards. Process fees apply. →

TiN = 131T-XXXX	TiAlN = 131A-XXXX
TiCN = 131N-XXXX	AM200® = 131H-XXXX



Inserts sold in quantities of 2

Original T-A Drill Inserts

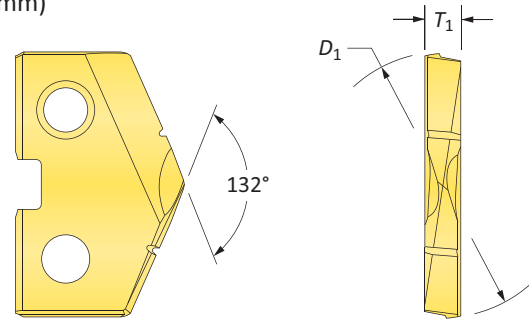

2 Series | HSS | Diameter Range: 0.961" - 1.380" (24.41mm - 35.05mm)



HSS Inserts – Premium Cobalt

Series	Fractional Equivalent	Insert			Part No.		
		D ₁ inch	D ₁ mm	T ₁	 TiN	 TiAlN	 TiCN
2	-	0.9646	24.50	3/16	182T-24.5	182A-24.5	182N-24.5
	31/32	0.9688	24.61	3/16	182T-0031	182A-0031	182N-0031
	-	0.9760	24.79	3/16	182T-.976	182A-.976	182N-.976
	63/64	0.9843	25.00	3/16	182T-25	182A-25	182N-25
	1	1.0000	25.40	3/16	182T-0100	182A-0100	182N-0100
	-	1.0039	25.50	3/16	182T-25.5	182A-25.5	182N-25.5
	1-1/64	1.0156	25.80	3/16	182T-1.015	182A-1.015	182N-1.015
	-	1.0236	26.00	3/16	182T-26	182A-26	182N-26
	1-1/32	1.0313	26.19	3/16	182T-0101	182A-0101	182N-0101
	-	1.0433	26.50	3/16	182T-26.5	182A-26.5	182N-26.5
	1-3/64	1.0469	26.59	3/16	182T-1.046	182A-1.046	182N-1.046
	1-1/16	1.0625	26.99	3/16	182T-0102	182A-0102	182N-0102
	-	1.0630	27.00	3/16	182T-27	182A-27	182N-27
	-	1.0827	27.50	3/16	182T-27.5	182A-27.5	182N-27.5
	1-3/32	1.0938	27.78	3/16	182T-0103	182A-0103	182N-0103
	-	1.1024	28.00	3/16	182T-28	182A-28	182N-28
	1-7/64	1.1094	28.18	3/16	182T-1.109	182A-1.109	182N-1.109
	-	1.1220	28.50	3/16	182T-28.5	182A-28.5	182N-28.5
	1-1/8	1.1250	28.58	3/16	182T-0104	182A-0104	182N-0104
	-	1.1417	29.00	3/16	182T-29	182A-29	182N-29
1-5/32	1.1563	29.37	3/16	182T-0105	182A-0105	182N-0105	
-	1.1614	29.50	3/16	182T-29.5	182A-29.5	182N-29.5	
-	1.1811	30.00	3/16	182T-30	182A-30	182N-30	
2.5	1-3/16	1.1875	30.16	3/16	182T-0106	182A-0106	182N-0106
	-	1.2008	30.50	3/16	182T-30.5	182A-30.5	182N-30.5
	1-7/32	1.2188	30.96	3/16	182T-0107	182A-0107	182N-0107
	-	1.2205	31.00	3/16	182T-31	182A-31	182N-31
	-	1.2260	31.14	3/16	182T-1.226	182A-1.226	182N-1.226
	-	1.2310	31.26	3/16	182T-1.231	182A-1.231	182N-1.231
	-	1.2340	31.34	3/16	182T-1.234	182A-1.234	182N-1.234
	-	1.2402	31.50	3/16	182T-31.5	182A-31.5	182N-31.5
	1-1/4	1.2500	31.75	3/16	182T-0108	182A-0108	182N-0108
	-	1.2598	32.00	3/16	182T-32	182A-32	182N-32
	-	1.2795	32.50	3/16	182T-32.5	182A-32.5	182N-32.5
	1-9/32	1.2813	32.54	3/16	182T-0109	182A-0109	182N-0109
	-	1.2992	33.00	3/16	182T-33	182A-33	182N-33
	1-5/16	1.3125	33.34	3/16	182T-0110	182A-0110	182N-0110
	-	1.3189	33.50	3/16	182T-33.5	182A-33.5	182N-33.5
	-	1.3386	34.00	3/16	182T-34	182A-34	182N-34
	1-11/32	1.3438	34.13	3/16	182T-0111	182A-0111	182N-0111
	-	1.3582	34.50	3/16	182T-34.5	182A-34.5	182N-34.5
	1-3/8	1.3750	34.93	3/16	182T-0112	182A-0112	182N-0112
	-	1.3780	35.00	3/16	182T-35	182A-35	182N-35

NOTE: 2.5 series inserts fit into both 2 and 2.5 series holders. However, 2 series inserts ONLY fit into 2 series holders. See page A30: 7 for visual.

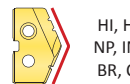
A30: 112 - 143   A30: 4 - 6 

HI, HR, CR, TC, SK, NP, IN, RN, CN, AN, BR, CI, CP, NC, WC

Coatings not listed above can be supplied as non-stocked standards. Process fees apply. 

Inserts sold in quantities of 2

TiN = 131T-XXXX	TiAlN = 131A-XXXX
TiCN = 131N-XXXX	AM200® = 131H-XXXX



A
DRILLING
B
BORING
C
REAMING
D
BURNISHING
E
THREADING
X
SPECIALS

Original T-A Drill Inserts

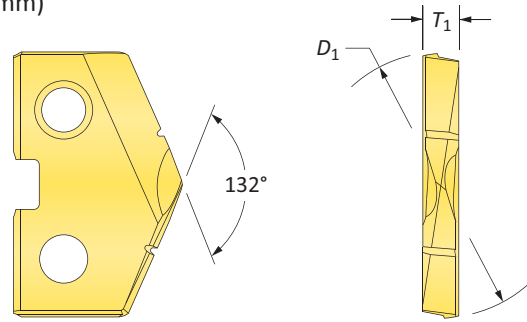
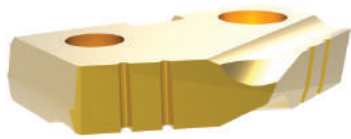

2 Series | HSS | Diameter Range: 0.961" - 1.380" (24.41mm - 35.05mm)



HSS Inserts – Super Cobalt

Series	Fractional Equivalent	Insert			Part No.		
		D_1 inch	D_1 mm	T_1	 TiN	 TiAlN	 TiCN
2	-	0.9646	24.50	3/16	152T-24.5	152A-24.5	152N-24.5
	31/32	0.9688	24.61	3/16	152T-0031	152A-0031	152N-0031
	-	0.9760	24.79	3/16	152T-.976	152A-.976	152N-.976
	63/64	0.9843	25.00	3/16	152T-25	152A-25	152N-25
	1	1.0000	25.40	3/16	152T-0100	152A-0100	152N-0100
	-	1.0039	25.50	3/16	152T-25.5	152A-25.5	152N-25.5
	1-1/64	1.0156	25.80	3/16	152T-1.015	152A-1.015	152N-1.015
	-	1.0236	26.00	3/16	152T-26	152A-26	152N-26
	1-1/32	1.0313	26.19	3/16	152T-0101	152A-0101	152N-0101
	-	1.0433	26.50	3/16	152T-26.5	152A-26.5	152N-26.5
	1-3/64	1.0469	26.59	3/16	152T-1.046	152A-1.046	152N-1.046
	1-1/16	1.0625	26.99	3/16	152T-0102	152A-0102	152N-0102
	-	1.0630	27.00	3/16	152T-27	152A-27	152N-27
	-	1.0827	27.50	3/16	152T-27.5	152A-27.5	152N-27.5
	1-3/32	1.0938	27.78	3/16	152T-0103	152A-0103	152N-0103
	-	1.1024	28.00	3/16	152T-28	152A-28	152N-28
	1-7/64	1.1094	28.18	3/16	152T-1.109	152A-1.109	152N-1.109
	-	1.1220	28.50	3/16	152T-28.5	152A-28.5	152N-28.5
	1-1/8	1.1250	28.58	3/16	152T-0104	152A-0104	152N-0104
	-	1.1417	29.00	3/16	152T-29	152A-29	152N-29
1-5/32	1.1563	29.37	3/16	152T-0105	152A-0105	152N-0105	
-	1.1614	29.50	3/16	152T-29.5	152A-29.5	152N-29.5	
-	1.1811	30.00	3/16	152T-30	152A-30	152N-30	
2.5	1-3/16	1.1875	30.16	3/16	152T-0106	152A-0106	152N-0106
	-	1.2008	30.50	3/16	152T-30.5	152A-30.5	152N-30.5
	1-7/32	1.2188	30.96	3/16	152T-0107	152A-0107	152N-0107
	-	1.2205	31.00	3/16	152T-31	152A-31	152N-31
	-	1.2260	31.14	3/16	152T-1.226	152A-1.226	152N-1.226
	-	1.2310	31.26	3/16	152T-1.231	152A-1.231	152N-1.231
	-	1.2340	31.34	3/16	152T-1.234	152A-1.234	152N-1.234
	-	1.2402	31.50	3/16	152T-31.5	152A-31.5	152N-31.5
	1-1/4	1.2500	31.75	3/16	152T-0108	152A-0108	152N-0108
	-	1.2598	32.00	3/16	152T-32	152A-32	152N-32
	-	1.2795	32.50	3/16	152T-32.5	152A-32.5	152N-32.5
	1-9/32	1.2813	32.54	3/16	152T-0109	152A-0109	152N-0109
	-	1.2992	33.00	3/16	152T-33	152A-33	152N-33
	1-5/16	1.3125	33.34	3/16	152T-0110	152A-0110	152N-0110
	-	1.3189	33.50	3/16	152T-33.5	152A-33.5	152N-33.5
	-	1.3386	34.00	3/16	152T-34	152A-34	152N-34
	1-11/32	1.3438	34.13	3/16	152T-0111	152A-0111	152N-0111
	-	1.3582	34.50	3/16	152T-34.5	152A-34.5	152N-34.5
	1-3/8	1.3750	34.93	3/16	152T-0112	152A-0112	152N-0112
	-	1.3780	35.00	3/16	152T-35	152A-35	152N-35

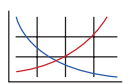
NOTE: 2.5 series inserts fit into both 2 and 2.5 series holders. However, 2 series inserts ONLY fit into 2 series holders. See page A30: 7 for visual.

A30: 112 - 143  A30: 70 - 74  A30: 4 - 6  HI, HR, CR, TC, SK, NP, IN, RN, CN, AN, BR, CI, CP, NC, WC

Coatings not listed above can be supplied as non-stocked standards. Process fees apply. →

TiN = 131T-XXXX	TiAlN = 131A-XXXX
TiCN = 131N-XXXX	AM200® = 131H-XXXX

Inserts sold in quantities of 2

Original T-A Drill Inserts



2 Series | HSS | Diameter Range: 0.961" - 1.380" (24.41mm - 35.05mm)

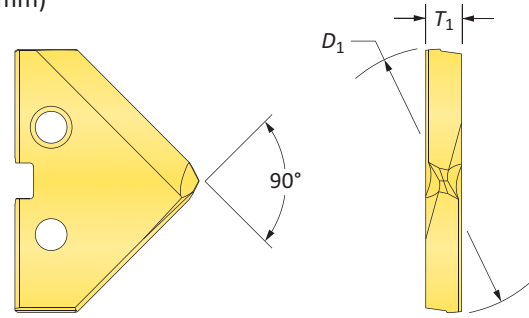

90° Spot & Chamfer





HSS Inserts – Super Cobalt

Series	Fractional Equivalent	Insert			90° Spot & Chamfer Part No.		
		D ₁ inch	D ₁ mm	T ₁	 TiN	 TiAlN	 TiCN
2	-	0.9646	24.50	3/16	152T-24.5-SP	152A-24.5-SP	152N-24.5-SP
	31/32	0.9688	24.61	3/16	152T-0031-SP	152A-0031-SP	152N-0031-SP
	-	0.9760	24.79	3/16	152T-.976-SP	152A-.976-SP	152N-.976-SP
	63/64	0.9843	25.00	3/16	152T-25-SP	152A-25-SP	152N-25-SP
	1	1.0000	25.40	3/16	152T-0100-SP	152A-0100-SP	152N-0100-SP
	-	1.0039	25.50	3/16	152T-25.5-SP	152A-25.5-SP	152N-25.5-SP
	1-1/64	1.0156	25.80	3/16	152T-1.015-SP	152A-1.015-SP	152N-1.015-SP
	-	1.0236	26.00	3/16	152T-26-SP	152A-26-SP	152N-26-SP
	1-1/32	1.0313	26.19	3/16	152T-0101-SP	152A-0101-SP	152N-0101-SP
	-	1.0433	26.50	3/16	152T-26.5-SP	152A-26.5-SP	152N-26.5-SP
	1-3/64	1.0469	26.59	3/16	152T-1.046-SP	152A-1.046-SP	152N-1.046-SP
	1-1/16	1.0625	26.99	3/16	152T-0102-SP	152A-0102-SP	152N-0102-SP
	-	1.0630	27.00	3/16	152T-27-SP	152A-27-SP	152N-27-SP
	-	1.0827	27.50	3/16	152T-27.5-SP	152A-27.5-SP	152N-27.5-SP
	1-3/32	1.0938	27.78	3/16	152T-0103-SP	152A-0103-SP	152N-0103-SP
	-	1.1024	28.00	3/16	152T-28-SP	152A-28-SP	152N-28-SP
	1-7/64	1.1094	28.18	3/16	152T-1.109-SP	152A-1.109-SP	152N-1.109-SP
	-	1.1220	28.50	3/16	152T-28.5-SP	152A-28.5-SP	152N-28.5-SP
	1-1/8	1.1250	28.58	3/16	152T-0104-SP	152A-0104-SP	152N-0104-SP
	-	1.1417	29.00	3/16	152T-29-SP	152A-29-SP	152N-29-SP
1-5/32	1.1563	29.37	3/16	152T-0105-SP	152A-0105-SP	152N-0105-SP	
-	1.1614	29.50	3/16	152T-29.5-SP	152A-29.5-SP	152N-29.5-SP	
-	1.1811	30.00	3/16	152T-30-SP	152A-30-SP	152N-30-SP	
2.5	1-3/16	1.1875	30.16	3/16	152T-0106-SP	152A-0106-SP	152N-0106-SP
	-	1.2008	30.50	3/16	152T-30.5-SP	152A-30.5-SP	152N-30.5-SP
	1-7/32	1.2188	30.96	3/16	152T-0107-SP	152A-0107-SP	152N-0107-SP
	-	1.2205	31.00	3/16	152T-31-SP	152A-31-SP	152N-31-SP
	-	1.2260	31.14	3/16	152T-1.226-SP	152A-1.226-SP	152N-1.226-SP
	-	1.2310	31.26	3/16	152T-1.231-SP	152A-1.231-SP	152N-1.231-SP
	-	1.2340	31.34	3/16	152T-1.234-SP	152A-1.234-SP	152N-1.234-SP
	-	1.2402	31.50	3/16	152T-31.5-SP	152A-31.5-SP	152N-31.5-SP
	1-1/4	1.2500	31.75	3/16	152T-0108-SP	152A-0108-SP	152N-0108-SP
	-	1.2598	32.00	3/16	152T-32-SP	152A-32-SP	152N-32-SP
	-	1.2795	32.50	3/16	152T-32.5-SP	152A-32.5-SP	152N-32.5-SP
	1-9/32	1.2813	32.54	3/16	152T-0109-SP	152A-0109-SP	152N-0109-SP
	-	1.2992	33.00	3/16	152T-33-SP	152A-33-SP	152N-33-SP
	1-5/16	1.3125	33.34	3/16	152T-0110-SP	152A-0110-SP	152N-0110-SP
	-	1.3189	33.50	3/16	152T-33.5-SP	152A-33.5-SP	152N-33.5-SP
	-	1.3386	34.00	3/16	152T-34-SP	152A-34-SP	152N-34-SP
	1-11/32	1.3438	34.13	3/16	152T-0111-SP	152A-0111-SP	152N-0111-SP
	-	1.3582	34.50	3/16	152T-34.5-SP	152A-34.5-SP	152N-34.5-SP
	1-3/8	1.3750	34.93	3/16	152T-0112-SP	152A-0112-SP	152N-0112-SP
	-	1.3780	35.00	3/16	152T-35-SP	152A-35-SP	152N-35-SP

NOTE: 2.5 series inserts fit into both 2 and 2.5 series holders. However, 2 series inserts ONLY fit into 2 series holders. See page A30: 7 for visual.

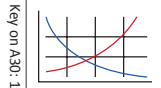
A30: 112 - 143 A30: 70 - 74 A30: 4 - 6

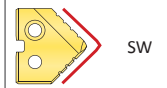
SW

Coatings not listed above can be supplied as non-stocked standards. Process fees apply. →

Inserts sold in quantities of 2

TiN = 131T-XXXX	TiAlN = 131A-XXXX
TiCN = 131N-XXXX	AM200® = 131H-XXXX

A DRILLING
B BORING
C REAMING
D BURNISHING
E THREADING
X SPECIALS

Original T-A Drill Inserts

2 Series | HSS | Diameter Range: 0.961" - 1.380" (24.41mm - 35.05mm)

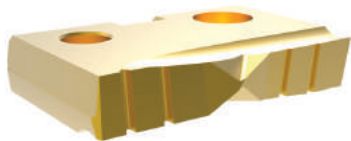

Flat Bottom

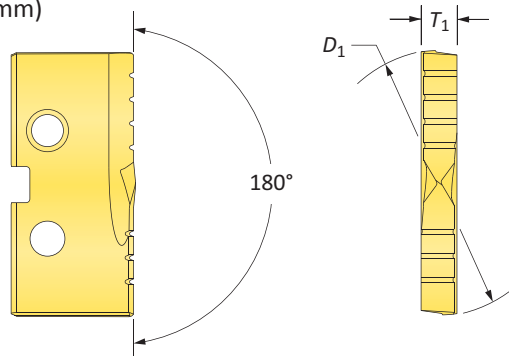

HSS Inserts – Super Cobalt

Series	Fractional Equivalent	Insert			Flat Bottom Part No.
		D_1 inch	D_1 mm	T_1	TiN 
2	-	0.9646	24.50	3/16	152T-24.5-FB
	31/32	0.9688	24.61	3/16	152T-0031-FB
	-	0.9760	24.79	3/16	152T-.976-FB
	63/64	0.9843	25.00	3/16	152T-25-FB
	1	1.0000	25.40	3/16	152T-0100-FB
	-	1.0039	25.50	3/16	152T-25.5-FB
	1-1/64	1.0156	25.80	3/16	152T-1.015-FB
	-	1.0236	26.00	3/16	152T-26-FB
	1-1/32	1.0313	26.19	3/16	152T-0101-FB
	-	1.0433	26.50	3/16	152T-26.5-FB
	1-3/64	1.0469	26.59	3/16	152T-1.046-FB
	1-1/16	1.0625	26.99	3/16	152T-0102-FB
	-	1.0630	27.00	3/16	152T-27-FB
	-	1.0827	27.50	3/16	152T-27.5-FB
	1-3/32	1.0938	27.78	3/16	152T-0103-FB
	-	1.1024	28.00	3/16	152T-28-FB
	1-7/64	1.1094	28.18	3/16	152T-1.109-FB
	-	1.1220	28.50	3/16	152T-28.5-FB
	1-1/8	1.1250	28.58	3/16	152T-0104-FB
	-	1.1417	29.00	3/16	152T-29-FB
1-5/32	1.1563	29.37	3/16	152T-0105-FB	
-	1.1614	29.50	3/16	152T-29.5-FB	
-	1.1811	30.00	3/16	152T-30-FB	
2.5	1-3/16	1.1875	30.16	3/16	152T-0106-FB
	-	1.2008	30.50	3/16	152T-30.5-FB
	1-7/32	1.2188	30.96	3/16	152T-0107-FB
	-	1.2205	31.00	3/16	152T-31-FB
	-	1.2260	31.14	3/16	152T-1.226-FB
	-	1.2310	31.26	3/16	152T-1.231-FB
	-	1.2340	31.34	3/16	152T-1.234-FB
	-	1.2402	31.50	3/16	152T-31.5-FB
	1-1/4	1.2500	31.75	3/16	152T-0108-FB
	-	1.2598	32.00	3/16	152T-32-FB
	-	1.2795	32.50	3/16	152T-32.5-FB
	1-9/32	1.2813	32.54	3/16	152T-0109-FB
	-	1.2992	33.00	3/16	152T-33-FB
	1-5/16	1.3125	33.34	3/16	152T-0110-FB
	-	1.3189	33.50	3/16	152T-33.5-FB
	-	1.3386	34.00	3/16	152T-34-FB
	1-11/32	1.3438	34.13	3/16	152T-0111-FB
	-	1.3582	34.50	3/16	152T-34.5-FB
	1-3/8	1.3750	34.93	3/16	152T-0112-FB
	-	1.3780	35.00	3/16	152T-35-FB

NOTE: 2.5 series inserts fit into both 2 and 2.5 series holders. However, 2 series inserts ONLY fit into 2 series holders. See page A30: 7 for visual.

Inserts sold in quantities of 2

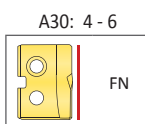
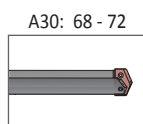
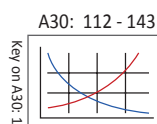

Coatings not listed above can be supplied as non-stocked standards. Process fees apply. →

TiN = 131T-XXXX	TiAlN = 131A-XXXX
TiCN = 131N-XXXX	AM200® = 131H-XXXX



Original T-A Drill Inserts

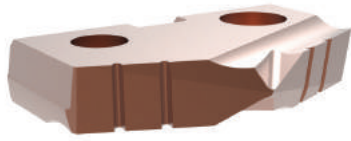

2 Series | HSS | Diameter Range: 0.961" - 1.380" (24.41mm - 35.05mm)

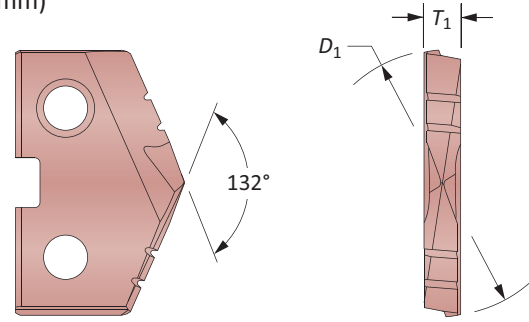

Tube Sheet



HSS Inserts – Super Cobalt | HSS

Series	Fractional Equivalent	Insert			Part No.	
		D_1 inch	D_1 mm	T_1	 Super Cobalt	 HSS
2	–	1.0080	25.60	3/16	152H-1.0080-IN	132H-1.0080-IN
	1-1/64	1.0156	25.80	3/16	152H-1.015-IN	132H-1.015-IN
	1-1/32	1.0313	26.19	3/16	152H-0101-IN	132H-0101-IN

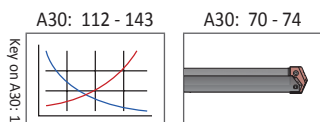

Inserts sold in quantities of 2

Coatings not listed above can be supplied as non-stocked standards. Process fees apply. →



TiN = 131T-XXXX	TiAlN = 131A-XXXX
TiCN = 131N-XXXX	AM200® = 131H-XXXX

Original T-A Drill Inserts

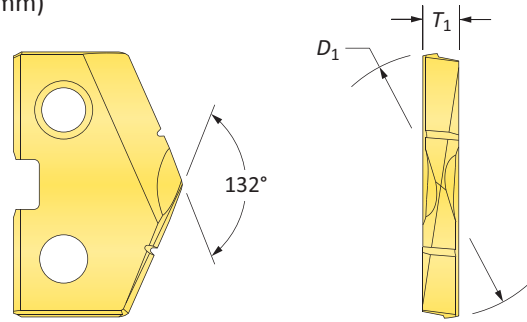
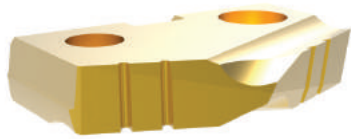
2 Series | HSS | Diameter Range: 0.961" - 1.380" (24.41mm - 35.05mm)





HSS Inserts – HSS

Series	Fractional Equivalent	Insert			Part No.		
		D_1 inch	D_1 mm	T_1	 TiN	 TiAlN	 TiCN
2	-	0.9646	24.50	3/16	132T-24.5	132A-24.5	132N-24.5
	31/32	0.9688	24.61	3/16	132T-0031	132A-0031	132N-0031
	-	0.9760	24.79	3/16	132T-.976	132A-.976	132N-.976
	63/64	0.9843	25.00	3/16	132T-25	132A-25	132N-25
	1	1.0000	25.40	3/16	132T-0100	132A-0100	132N-0100
	-	1.0039	25.50	3/16	132T-25.5	132A-25.5	132N-25.5
	1-1/64	1.0156	25.80	3/16	132T-1.015	132A-1.015	132N-1.015
	-	1.0236	26.00	3/16	132T-26	132A-26	132N-26
	1-1/32	1.0313	26.19	3/16	132T-0101	132A-0101	132N-0101
	-	1.0433	26.50	3/16	132T-26.5	132A-26.5	132N-26.5
	1-3/64	1.0469	26.59	3/16	132T-1.046	132A-1.046	132N-1.046
	1-1/16	1.0625	26.99	3/16	132T-0102	132A-0102	132N-0102
	-	1.0630	27.00	3/16	132T-27	132A-27	132N-27
	-	1.0827	27.50	3/16	132T-27.5	132A-27.5	132N-27.5
	1-3/32	1.0938	27.78	3/16	132T-0103	132A-0103	132N-0103
	-	1.1024	28.00	3/16	132T-28	132A-28	132N-28
	1-7/64	1.1094	28.18	3/16	132T-1.109	132A-1.109	132N-1.109
	-	1.1220	28.50	3/16	132T-28.5	132A-28.5	132N-28.5
	1-1/8	1.1250	28.58	3/16	132T-0104	132A-0104	132N-0104
	-	1.1417	29.00	3/16	132T-29	132A-29	132N-29
1-5/32	1.1563	29.37	3/16	132T-0105	132A-0105	132N-0105	
-	1.1614	29.50	3/16	132T-29.5	132A-29.5	132N-29.5	
-	1.1811	30.00	3/16	132T-30	132A-30	132N-30	
2.5	1-3/16	1.1875	30.16	3/16	132T-0106	132A-0106	132N-0106
	-	1.2008	30.50	3/16	132T-30.5	132A-30.5	132N-30.5
	1-7/32	1.2188	30.96	3/16	132T-0107	132A-0107	132N-0107
	-	1.2205	31.00	3/16	132T-31	132A-31	132N-31
	-	1.2260	31.14	3/16	132T-1.226	132A-1.226	132N-1.226
	-	1.2310	31.26	3/16	132T-1.231	132A-1.231	132N-1.231
	-	1.2340	31.34	3/16	132T-1.234	132A-1.234	132N-1.234
	-	1.2402	31.50	3/16	132T-31.5	132A-31.5	132N-31.5
	1-1/4	1.2500	31.75	3/16	132T-0108	132A-0108	132N-0108
	-	1.2598	32.00	3/16	132T-32	132A-32	132N-32
	-	1.2795	32.50	3/16	132T-32.5	132A-32.5	132N-32.5
	1-9/32	1.2813	32.54	3/16	132T-0109	132A-0109	132N-0109
	-	1.2992	33.00	3/16	132T-33	132A-33	132N-33
	1-5/16	1.3125	33.34	3/16	132T-0110	132A-0110	132N-0110
	-	1.3189	33.50	3/16	132T-33.5	132A-33.5	132N-33.5
	-	1.3386	34.00	3/16	132T-34	132A-34	132N-34
	1-11/32	1.3438	34.13	3/16	132T-0111	132A-0111	132N-0111
	-	1.3582	34.50	3/16	132T-34.5	132A-34.5	132N-34.5
	1-3/8	1.3750	34.93	3/16	132T-0112	132A-0112	132N-0112
	-	1.3780	35.00	3/16	132T-35	132A-35	132N-35

NOTE: 2.5 series inserts fit into both 2 and 2.5 series holders. However, 2 series inserts ONLY fit into 2 series holders. See page A30: 7 for visual.

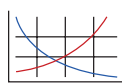
Inserts sold in quantities of 2

A30: 112 - 143  Key on A30: 1

A30: 70 - 74 

A30: 4 - 6  HI, HR, CR, TC, SK, NP, IN, RN, CN, AN, BR, CI, CP, NC, WC

Coatings not listed above can be supplied as non-stocked standards. Process fees apply. →

TiN = 131T-XXXX	TiAlN = 131A-XXXX
TiCN = 131N-XXXX	AM200® = 131H-XXXX





Original T-A Drill Inserts

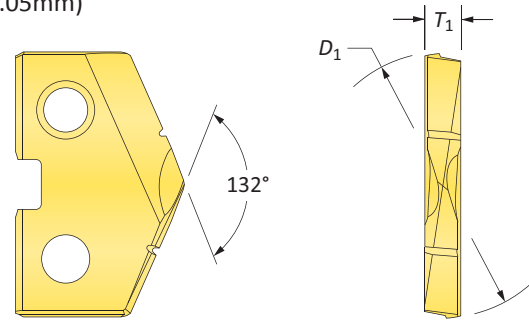

2 Series | Carbide | Diameter Range: 0.961" - 1.380" (24.41mm - 35.05mm)



Carbide Inserts – C2 (K20)

Series	Fractional Equivalent	Insert			Part No.	
		D ₁ inch	D ₁ mm	T ₁	 TiN	 TiAlN
2	-	0.9646	24.50	3/16	1C22T-24.5	1C22A-24.5
	31/32	0.9688	24.61	3/16	1C22T-0031	1C22A-0031
	-	0.9760	24.79	3/16	1C22T-.976	1C22A-.976
	63/64	0.9843	25.00	3/16	1C22T-25	1C22A-25
	1	1.0000	25.40	3/16	1C22T-0100	1C22A-0100
	-	1.0039	25.50	3/16	1C22T-25.5	1C22A-25.5
	1-1/64	1.0156	25.80	3/16	1C22T-1.015	1C22A-1.015
	-	1.0236	26.00	3/16	1C22T-26	1C22A-26
	1-1/32	1.0313	26.19	3/16	1C22T-0101	1C22A-0101
	-	1.0433	26.50	3/16	1C22T-26.5	1C22A-26.5
	1-3/64	1.0469	26.59	3/16	1C22T-1.046	1C22A-1.046
	1-1/16	1.0625	26.99	3/16	1C22T-0102	1C22A-0102
	-	1.0630	27.00	3/16	1C22T-27	1C22A-27
	-	1.0827	27.50	3/16	1C22T-27.5	1C22A-27.5
	1-3/32	1.0938	27.78	3/16	1C22T-0103	1C22A-0103
	-	1.1024	28.00	3/16	1C22T-28	1C22A-28
	1-7/64	1.1094	28.18	3/16	1C22T-1.109	1C22A-1.109
	-	1.1220	28.50	3/16	1C22T-28.5	1C22A-28.5
	1-1/8	1.1250	28.58	3/16	1C22T-0104	1C22A-0104
	-	1.1417	29.00	3/16	1C22T-29	1C22A-29
1-5/32	1.1563	29.37	3/16	1C22T-0105	1C22A-0105	
-	1.1614	29.50	3/16	1C22T-29.5	1C22A-29.5	
-	1.1811	30.00	3/16	1C22T-30	1C22A-30	
2.5	1-3/16	1.1875	30.16	3/16	1C22T-0106	1C22A-0106
	-	1.2008	30.50	3/16	1C22T-30.5	1C22A-30.5
	1-7/32	1.2188	30.96	3/16	1C22T-0107	1C22A-0107
	-	1.2205	31.00	3/16	1C22T-31	1C22A-31
	-	1.2260	31.14	3/16	1C22T-1.226	1C22A-1.226
	-	1.2310	31.26	3/16	1C22T-1.231	1C22A-1.231
	-	1.2340	31.34	3/16	1C22T-1.234	1C22A-1.234
	-	1.2402	31.50	3/16	1C22T-31.5	1C22A-31.5
	1-1/4	1.2500	31.75	3/16	1C22T-0108	1C22A-0108
	-	1.2598	32.00	3/16	1C22T-32	1C22A-32
	-	1.2795	32.50	3/16	1C22T-32.5	1C22A-32.5
	1-9/32	1.2813	32.54	3/16	1C22T-0109	1C22A-0109
	-	1.2992	33.00	3/16	1C22T-33	1C22A-33
	1-5/16	1.3125	33.34	3/16	1C22T-0110	1C22A-0110
	-	1.3189	33.50	3/16	1C22T-33.5	1C22A-33.5
	-	1.3386	34.00	3/16	1C22T-34	1C22A-34
	1-11/32	1.3438	34.13	3/16	1C22T-0111	1C22A-0111
	-	1.3582	34.50	3/16	1C22T-34.5	1C22A-34.5
	1-3/8	1.3750	34.93	3/16	1C22T-0112	1C22A-0112
	-	1.3780	35.00	3/16	1C22T-35	1C22A-35

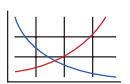
NOTE: 2.5 series inserts fit into both 2 and 2.5 series holders. However, 2 series inserts ONLY fit into 2 series holders. See page A30: 7 for visual.

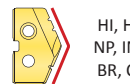
A30: 112 - 143  A30: 70 - 74  A30: 4 - 6  HI, HR, CR, TC, SK, NP, IN, RN, CN, AN, BR, CI, CP, NC, WC

Coatings not listed above can be supplied as non-stocked standards. Process fees apply. →

TiN = 131T-XXXX	TiAlN = 131A-XXXX
TiCN = 131N-XXXX	AM200® = 131H-XXXX

Inserts sold in quantities of 2

Original T-A Drill Inserts

2 Series | Carbide | Diameter Range: 0.961" - 1.380" (24.41mm - 35.05mm)

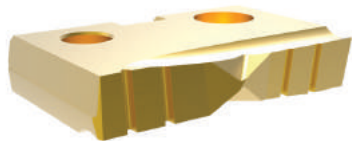

Flat Bottom

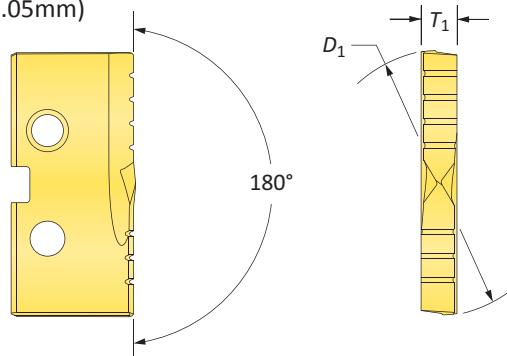

Carbide Inserts – C2 (K20)

Series	Fractional Equivalent	Insert			Flat Bottom Part No.
		D_1 inch	D_1 mm	T_1	TiN 
2	-	0.9646	24.50	3/16	1C22T-24.5-FB
	31/32	0.9688	24.61	3/16	1C22T-0031-FB
	-	0.9760	24.79	3/16	1C22T-976-FB
	63/64	0.9843	25.00	3/16	1C22T-25-FB
	1	1.0000	25.40	3/16	1C22T-0100-FB
	-	1.0039	25.50	3/16	1C22T-25.5-FB
	1-1/64	1.0156	25.80	3/16	1C22T-1.015-FB
	-	1.0236	26.00	3/16	1C22T-26-FB
	1-1/32	1.0313	26.19	3/16	1C22T-0101-FB
	-	1.0433	26.50	3/16	1C22T-26.5-FB
	1-3/64	1.0469	26.59	3/16	1C22T-1.046-FB
	1-1/16	1.0625	26.99	3/16	1C22T-0102-FB
	-	1.0630	27.00	3/16	1C22T-27-FB
	-	1.0827	27.50	3/16	1C22T-27.5-FB
	1-3/32	1.0938	27.78	3/16	1C22T-0103-FB
	-	1.1024	28.00	3/16	1C22T-28-FB
	1-7/64	1.1094	28.18	3/16	1C22T-1.109-FB
	-	1.1220	28.50	3/16	1C22T-28.5-FB
	1-1/8	1.1250	28.58	3/16	1C22T-0104-FB
	-	1.1417	29.00	3/16	1C22T-29-FB
1-5/32	1.1563	29.37	3/16	1C22T-0105-FB	
-	1.1614	29.50	3/16	1C22T-29.5-FB	
-	1.1811	30.00	3/16	1C22T-30-FB	
2.5	1-3/16	1.1875	30.16	3/16	1C22T-0106-FB
	-	1.2008	30.50	3/16	1C22T-30.5-FB
	1-7/32	1.2188	30.96	3/16	1C22T-0107-FB
	-	1.2205	31.00	3/16	1C22T-31-FB
	-	1.2260	31.14	3/16	1C22T-1.226-FB
	-	1.2310	31.26	3/16	1C22T-1.231-FB
	-	1.2340	31.34	3/16	1C22T-1.234-FB
	-	1.2402	31.50	3/16	1C22T-31.5-FB
	1-1/4	1.2500	31.75	3/16	1C22T-0108-FB
	-	1.2598	32.00	3/16	1C22T-32-FB
	-	1.2795	32.50	3/16	1C22T-32.5-FB
	1-9/32	1.2813	32.54	3/16	1C22T-0109-FB
	-	1.2992	33.00	3/16	1C22T-33-FB
	1-5/16	1.3125	33.34	3/16	1C22T-0110-FB
	-	1.3189	33.50	3/16	1C22T-33.5-FB
	-	1.3386	34.00	3/16	1C22T-34-FB
	1-11/32	1.3438	34.13	3/16	1C22T-0111-FB
	-	1.3582	34.50	3/16	1C22T-34.5-FB
	1-3/8	1.3750	34.93	3/16	1C22T-0112-FB
	-	1.3780	35.00	3/16	1C22T-35-FB

NOTE: 2.5 series inserts fit into both 2 and 2.5 series holders. However, 2 series inserts ONLY fit into 2 series holders. See page A30: 7 for visual.

Inserts sold in quantities of 2

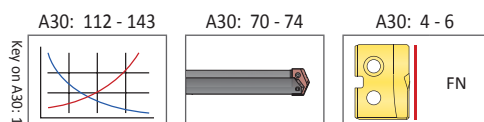

Coatings not listed above can be supplied as non-stocked standards. Process fees apply. →

TiN = 131T-XXXX	TiAlN = 131A-XXXX
TiCN = 131N-XXXX	AM200® = 131H-XXXX

Original T-A Drill Inserts

2 Series | Carbide | Diameter Range: 0.961" - 1.380" (24.41mm - 35.05mm)

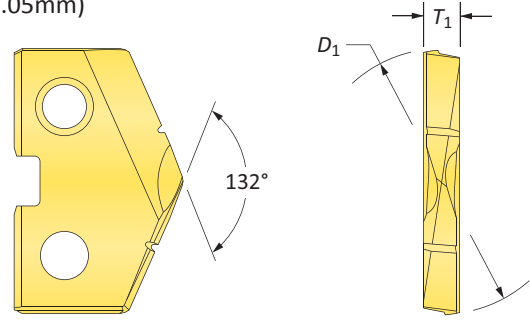

Carbide Inserts – C5 (P40) | C3 (K10) | N2

Series	Insert				C5 Part No.		C3 Part No.	N2 Part No.
	Fractional Equivalent	D ₁ inch	D ₁ mm	T ₁	TiN	TiAlN	TiAlN (Cast Iron)	Diamond Film
2	-	0.9646	24.50	3/16	1C52T-24.5	1C52A-24.5	1C32A-24.5-CI	1N22D-24.5
	31/32	0.9688	24.61	3/16	1C52T-0031	1C52A-0031	1C32A-0031-CI	1N22D-0031
	-	0.9760	24.79	3/16	1C52T-.976	1C52A-.976	1C32A-.976-CI	1N22D-.976
	63/64	0.9843	25.00	3/16	1C52T-25	1C52A-25	1C32A-25-CI	1N22D-25
	1	1.0000	25.40	3/16	1C52T-0100	1C52A-0100	1C32A-0100-CI	1N22D-0100
	-	1.0039	25.50	3/16	1C52T-25.5	1C52A-25.5	1C32A-25.5-CI	1N22D-25.5
	1-1/64	1.0156	25.80	3/16	1C52T-1.015	1C52A-1.015	1C32A-1.015-CI	1N22D-1.015
	-	1.0236	26.00	3/16	1C52T-26	1C52A-26	1C32A-26-CI	1N22D-26
	1-1/32	1.0313	26.19	3/16	1C52T-0101	1C52A-0101	1C32A-0101-CI	1N22D-0101
	-	1.0433	26.50	3/16	1C52T-26.5	1C52A-26.5	1C32A-26.5-CI	1N22D-26.5
	1-3/64	1.0469	26.59	3/16	1C52T-1.046	1C52A-1.046	1C32A-1.046-CI	1N22D-1.046
	1-1/16	1.0625	26.99	3/16	1C52T-0102	1C52A-0102	1C32A-0102-CI	1N22D-0102
	-	1.0630	27.00	3/16	1C52T-27	1C52A-27	1C32A-27-CI	1N22D-27
	-	1.0827	27.50	3/16	1C52T-27.5	1C52A-27.5	1C32A-27.5-CI	1N22D-27.5
	1-3/32	1.0938	27.78	3/16	1C52T-0103	1C52A-0103	1C32A-0103-CI	1N22D-0103
	-	1.1024	28.00	3/16	1C52T-28	1C52A-28	1C32A-28-CI	1N22D-28
	1-7/64	1.1094	28.18	3/16	1C52T-1.109	1C52A-1.109	1C32A-1.109-CI	1N22D-1.109
	-	1.1220	28.50	3/16	1C52T-28.5	1C52A-28.5	1C32A-28.5-CI	1N22D-28.5
	1-1/8	1.1250	28.58	3/16	1C52T-0104	1C52A-0104	1C32A-0104-CI	1N22D-0104
	-	1.1417	29.00	3/16	1C52T-29	1C52A-29	1C32A-29-CI	1N22D-29
1-5/32	1.1563	29.37	3/16	1C52T-0105	1C52A-0105	1C32A-0105-CI	1N22D-0105	
-	1.1614	29.50	3/16	1C52T-29.5	1C52A-29.5	1C32A-29.5-CI	1N22D-29.5	
-	1.1811	30.00	3/16	1C52T-30	1C52A-30	1C32A-30-CI	1N22D-30	
2.5	1-3/16	1.1875	30.16	3/16	1C52T-0106	1C52A-0106	1C32A-0106-CI	1N22D-0106
	-	1.2008	30.50	3/16	1C52T-30.5	1C52A-30.5	1C32A-30.5-CI	1N22D-30.5
	1-7/32	1.2188	30.96	3/16	1C52T-0107	1C52A-0107	1C32A-0107-CI	1N22D-0107
	-	1.2205	31.00	3/16	1C52T-31	1C52A-31	1C32A-31-CI	1N22D-31
	-	1.2260	31.14	3/16	1C52T-1.226	1C52A-1.226	1C32A-1.226-CI	1N22D-1.226
	-	1.2310	31.26	3/16	1C52T-1.231	1C52A-1.231	1C32A-1.231-CI	1N22D-1.231
	-	1.2340	31.34	3/16	1C52T-1.234	1C52A-1.234	1C32A-1.234-CI	1N22D-1.234
	-	1.2402	31.50	3/16	1C52T-31.5	1C52A-31.5	1C32A-31.5-CI	1N22D-31.5
	1-1/4	1.2500	31.75	3/16	1C52T-0108	1C52A-0108	1C32A-0108-CI	1N22D-0108
	-	1.2598	32.00	3/16	1C52T-32	1C52A-32	1C32A-32-CI	1N22D-32
	-	1.2795	32.50	3/16	1C52T-32.5	1C52A-32.5	1C32A-32.5-CI	1N22D-32.5
	1-9/32	1.2813	32.54	3/16	1C52T-0109	1C52A-0109	1C32A-0109-CI	1N22D-0109
	-	1.2992	33.00	3/16	1C52T-33	1C52A-33	1C32A-33-CI	1N22D-33
	1-5/16	1.3125	33.34	3/16	1C52T-0110	1C52A-0110	1C32A-0110-CI	1N22D-0110
	-	1.3189	33.50	3/16	1C52T-33.5	1C52A-33.5	1C32A-33.5-CI	1N22D-33.5
	-	1.3386	34.00	3/16	1C52T-34	1C52A-34	1C32A-34-CI	1N22D-34
	1-11/32	1.3438	34.13	3/16	1C52T-0111	1C52A-0111	1C32A-0111-CI	1N22D-0111
	-	1.3582	34.50	3/16	1C52T-34.5	1C52A-34.5	1C32A-34.5-CI	1N22D-34.5
	1-3/8	1.3750	34.93	3/16	1C52T-0112	1C52A-0112	1C32A-0112-CI	1N22D-0112
	-	1.3780	35.00	3/16	1C52T-35	1C52A-35	1C32A-35-CI	1N22D-35

NOTE: 2.5 series inserts fit into both 2 and 2.5 series holders. However, 2 series inserts ONLY fit into 2 series holders. See page A30: 7 for visual.

A30: 112 - 143 A30: 70 - 74 A30: 4 - 6 HI, HR, CR, TC, SK, NP, IN, RN, CN, AN, BR, CI, CP, NC, WC

Coatings not listed above can be supplied as non-stocked standards. Process fees apply. →

Inserts sold in quantities of 2

TiN = 131T-XXXX	TiAlN = 131A-XXXX
TiCN = 131N-XXXX	AM200® = 131H-XXXX

A DRILLING
B BORING
C REAMING
D BURNISHING
E THREADING
X SPECIALS

T-A Drill Insert Holders

2 Series | Flange Shank

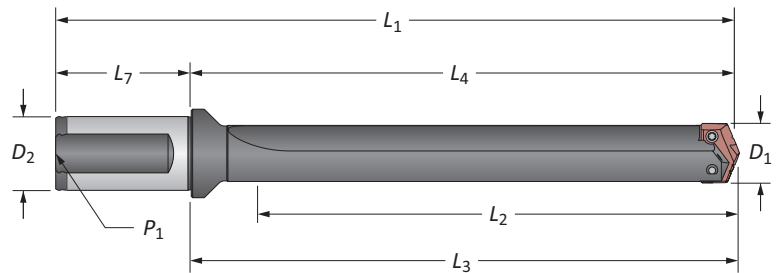

Stub Length

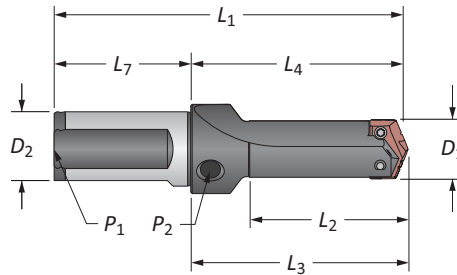

Straight Flute

Series	Length	D_1	Body				Shank			Part No.	
			L_2	L_4	L_3	L_1	D_2	L_7	P_1		
2	Stub	31/32 - 1-3/8	2-1/4	3-31/64	3-5/8	5-49/64	1-1/4	2-9/32	1/4	21020S-125F	
	Short	31/32 - 1-3/8	3-5/8	5-1/16	5-13/64	7-11/32	1-1/4	2-9/32	1/4	22020S-125F	
	Intermediate	31/32 - 1-3/8	5-3/8	7-1/16	7-13/64	9-11/32	1-1/4	2-9/32	1/4	23020S-125F	
	Standard	31/32 - 1-3/8	7-3/8	9-1/16	9-13/64	11-11/32	1-1/4	2-9/32	1/4	24020S-125F	
	Extended	31/32 - 1-3/8	11-3/8	13-1-16	13-13/64	15-11/32	1-1/4	2-9/32	1/4	25020S-125F	
2.5	Stub	1-3/16 - 1-3/8	3-5/8	4-55/64	5	7-9/64	1-1/4	2-9/32	1/4	21025S-125F	
	Short	1-3/16 - 1-3/8	3-5/8	5-1/16	5-13/64	7-11/32	1-1/4	2-9/32	1/4	22025S-125F	
	Intermediate	1-3/16 - 1-3/8	5-3/8	7-1/16	7-13/64	9-11/32	1-1/4	2-9/32	1/4	23025S-125F	
	Standard	1-3/16 - 1-3/8	7-3/8	9-1/16	9-13/64	11-11/32	1-1/4	2-9/32	1/4	24025S-125F	
	Extended	1-3/16 - 1-3/8	11-3/8	13-1-16	13-13/64	15-11/32	1-1/4	2-9/32	1/4	25025S-125F	
2	Stub	25.0 - 35.0	57.2	88.5	92.1	148.5	32.0	60.0	1/4*	21020S-32FM	
	Short	25.0 - 35.0	85.7	128.6	132.2	188.6	32.0	60.0	1/4*	22020S-32FM	
	XL	25.0 - 35.0	511.0	554.1	557.7	614.1	32.0	60.0	1/4*	27020S-32FM	
	3XL	25.0 - 35.0	692.0	735.1	738.7	795.1	32.0	60.0	1/4*	29020S-32FM	
	2.5	Stub	30.0 - 35.0	92.1	123.4	127.0	183.4	32.0	60.0	1/4*	21025S-32FM
		Short	30.0 - 35.0	85.7	128.6	132.2	188.6	32.0	60.0	1/4*	22025S-32FM

*Metric thread to BSP and ISO 7-1

NOTE: Stub length holders have a 1/8" side pipe tap (P_2)

Connection Accessories

Insert Screws	Nylon Locking Screws	Insert Driver	Preset Torque Hand Driver	Replacement Tips	Admissible Tightening Torque*
7495-IP15-1	7495N-IP15-1	8IP-15	8IP-15TL	8IP-15B	61.0 in-lbs (690 N-cm)

*Tightening torques are calculated with a friction coefficient of $\mu = 0.14$ and develop 90% of ultimate yield strength

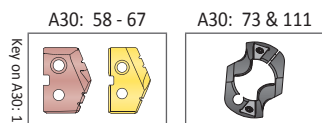

Key on A30: 1

i = Imperial (in)

m = Metric (mm)

Screws sold in quantities of 10

WARNING Refer to Speed and Feed charts for recommended adjustments to speeds and feeds. Refer to page A30: 146 for deep hole drilling guidelines in this section of the catalog. Visit www.alliedmachine.com/DeepHoleGuidelines for the most up-to-date information and procedures. Factory technical assistance is available for your specific applications through our Application Engineering Team.

T-A Drill Insert Holders

2 Series | Flange Shank

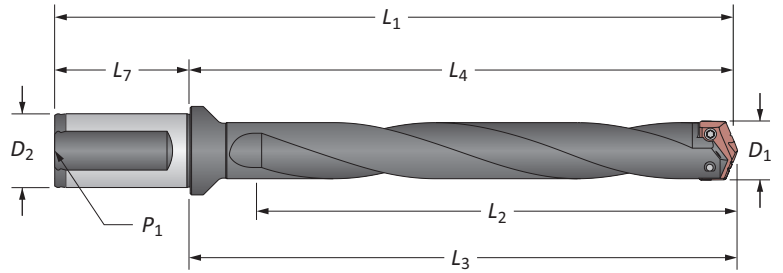

Helical Flute

Series	Length	Body					Shank			Part No.		
		D ₁	L ₂	L ₄	L ₃	L ₁	D ₂	L ₇	P ₁			
i	2	Intermediate	31/32 - 1-3/8	5-3/8	7-1/16	7-13/64	9-11/32	1-1/4	2-9/32	1/4	23020H-125F	
		Standard	31/32 - 1-3/8	7-3/8	9-1/16	9-13/64	11-11/32	1-1/4	2-9/32	1/4	24020H-125F	
		Standard Plus	31/32 - 1-3/8	9-3/8	11-1/16	11-13/64	13-31/64	1-1/4	2-9/32	1/4	24520H-125F	
		Extended	31/32 - 1-3/8	11-3/8	13-1/16	13-13/64	15-11/32	1-1/4	2-9/32	1/4	25020H-125F	
		Long	31/32 - 1-3/8	16-1/8	17-53/64	7-31/32	20-1/4	1-1/4	2-9/32	1/4	26020H-125F	
2.5	2	Intermediate	1-3/16 - 1-3/8	5-3/8	7-1/16	7-13/64	9-11/32	1-1/4	2-9/32	1/4	23025H-125F	
		Standard	1-3/16 - 1-3/8	7-3/8	9-1/16	9-13/64	11-11/32	1-1/4	2-9/32	1/4	24025H-125F	
		Extended	1-3/16 - 1-3/8	11-3/8	13-1/16	13-13/64	15-11/32	1-1/4	2-9/32	1/4	25025H-125F	
ii	2	Intermediate	25.0 - 35.0	136.5	179.4	183.0	239.4	32.0	60.0	1/4*	23020H-32FM	
		Standard	25.0 - 35.0	187.3	230.2	233.8	290.2	32.0	60.0	1/4*	24020H-32FM	
		Standard Plus	25.0 - 35.0	238.0	280.9	284.5	340.9	32.0	60.0	1/4*	24520H-32FM	
		Extended	25.0 - 35.0	288.9	331.8	335.4	391.8	32.0	60.0	1/4*	25020H-32FM	
		Long	25.0 - 35.0	410.0	452.9	456.5	512.9	32.0	60.0	1/4*	26020H-32FM	
	2.5	2	Intermediate	30.0 - 35.0	136.5	179.4	183.0	239.4	32.0	60.0	1/4*	23025H-32FM
			Standard	30.0 - 35.0	187.3	230.2	233.8	290.2	32.0	60.0	1/4*	24025H-32FM
			Extended	30.0 - 35.0	288.9	331.8	335.4	391.8	32.0	60.0	1/4*	25025H-32FM

*Metric thread to BSP and ISO 7-1

Connection Accessories

Insert Screws	Nylon Locking Screws	Insert Driver	Preset Torque Hand Driver	Replacement Tips	Admissible Tightening Torque*
7495-IP15-1	7495N-IP15-1	8IP-15	8IP-15TL	8IP-15B	61.0 in-lbs (690 N-cm)

*Tightening torques are calculated with a friction coefficient of $\mu = 0.14$ and develop 90% of ultimate yield strength

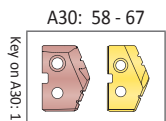

i = Imperial (in)
m = Metric (mm)

Screws sold in quantities of 10

WARNING Refer to Speed and Feed charts for recommended adjustments to speeds and feeds. Refer to page A30: 146 for deep hole drilling guidelines in this section of the catalog. Visit www.alliedmachine.com/DeepHoleGuidelines for the most up-to-date information and procedures. Factory technical assistance is available for your specific applications through our Application Engineering Team.

A DRILLING
B BORING
C REAMING
D BURNISHING
E THREADING
X SPECIALS

T-A Drill Insert Holders

2 Series | Taper Shank

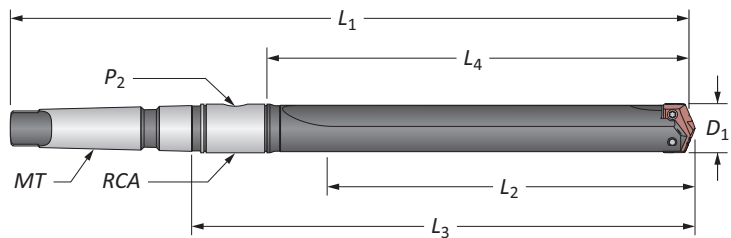

Straight Flute

Series	Length	D ₁	Body				Shank			Part No.	
			L ₂	L ₃	L ₄	L ₁	MT	P ₂	RCA		
2	Short	31/32 - 1-3/8	3-3/8	4-1/2	6-15/64	9-25/32	#3	1/8	2T-3SR	22020S-003I	
	Short	31/32 - 1-3/8	3-3/8	4-1/2	6-19/64	10-25/32	#4	1/8	2T-3SR	22020S-004I	
	Intermediate	31/32 - 1-3/8	5-3/8	6-1/2	8-19/64	12-25/32	#4	1/8	2T-3SR	23020S-004I	
	Standard	31/32 - 1-3/8	7-3/8	8-1/2	10-15/64	13-25/32	#3	1/8	2T-3SR	24020S-003I	
	Standard	31/32 - 1-3/8	7-3/8	8-1/2	10-19/64	14-25/32	#4	1/8	2T-3SR	24020S-004I	
2.5	Extended	31/32 - 1-3/8	11-3/8	12-1/2	14-15/64	18-25/32	#4	1/4	2T-3SR	25020S-004I	
	Short	1-3/16 - 1-3/8	3-3/8	4-1/2	6-15/64	9-25/32	#3	1/8	2T-3SR	22025S-003I	
	Short	1-3/16 - 1-3/8	3-3/8	4-1/2	6-37/64	11-1/16	#4	1/4	2T-4SR	22025S-004I	
	Intermediate	1-3/16 - 1-3/8	5-3/8	6-1/2	8-37/64	13-1/16	#4	1/4	2T-4SR	23025S-004I	
	Standard	1-3/16 - 1-3/8	7-3/8	8-1/2	10-15/64	13-25/32	#3	1/8	2T-3SR	24025S-003I	
2	Standard	1-3/16 - 1-3/8	7-3/8	8-1/2	10-37/64	15-1/16	#4	1/8	2T-4SR	24025S-004I	
	Extended	1-3/16 - 1-3/8	11-3/8	12-1/2	14-37/64	19-1/16	#4	1/4	2T-4SR	25025S-004I	
m	2	Short	25.0 - 35.0	69.8	98.4	142.5	232.5	#4**	1/8*	2T-3SRM	22020S-004M
	2.5	Short	30.0 - 35.0	69.8	98.4	142.5	232.5	#4**	1/8*	2T-4SRM	22025S-004M

*Metric thread to BSP and ISO 7-1

**Per ISO 296 type BEK

Connection Accessories

Insert Screws	Nylon Locking Screws	Insert Driver	Preset Torque Hand Driver	Replacement Tips	Admissible Tightening Torque*
7495-IP15-1	7495N-IP15-1	8IP-15	8IP-15TL	8IP-15B	61.0 in-lbs (690 N-cm)

*Tightening torques are calculated with a friction coefficient of $\mu = 0.14$ and develop 90% of ultimate yield strength

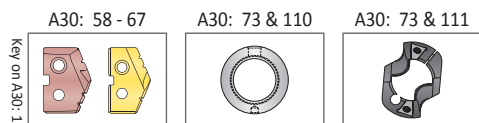

i = Imperial (in)

m = Metric (mm)

Screws sold in quantities of 10

WARNING Refer to Speed and Feed charts for recommended adjustments to speeds and feeds. Refer to page A30: 146 for deep hole drilling guidelines in this section of the catalog. Visit www.alliedmachine.com/DeepHoleGuidelines for the most up-to-date information and procedures. Factory technical assistance is available for your specific applications through our Application Engineering Team.

T-A Drill Insert Holders

2 Series | Taper Shank

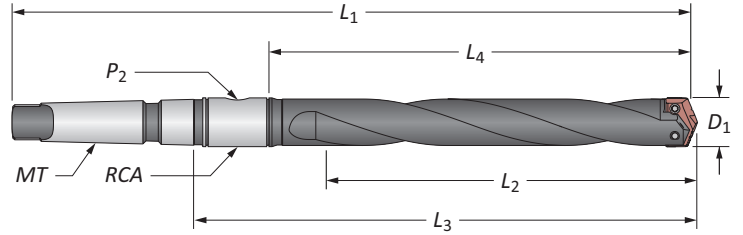

Helical Flute

Series	Length	D ₁	Body				Shank			Part No.	
			L ₂	L ₃	L ₄	L ₁	MT	P ₂	RCA		
i	2	Intermediate	31/32 - 1-3/8	5-3/8	6-1/2	8-19/64	12-25/32	#4	1/8	2T-3SR	23020H-004I
		Standard	31/32 - 1-3/8	7-3/8	8-1/2	10-15/64	13-25/32	#3	1/8	2T-3SR	24020H-003I
		Standard	31/32 - 1-3/8	7-3/8	8-1/2	10-19/64	14-25/32	#4	1/8	2T-3SR	24020H-004I
	Extended	31/32 - 1-3/8	11-3/8	12-1/2	14-15/64	18-25/32	#4	1/8	2T-3SR	25020H-004I	
i	2.5	Intermediate	1-3/16 - 1-3/8	5-3/8	6-1/2	8-37/64	13-1/16	#4	1/4	2T-4SR	23025H-004I
		Standard	1-3/16 - 1-3/8	7-3/8	8-1/2	10-15/64	13-25/32	#3	1/8	2T-3SR	24025H-003I
		Standard	1-3/16 - 1-3/8	7-3/8	8-1/2	10-37/64	15-1/6	#4	1/4	2T-4SR	24025H-004I
	Extended	1-3/16 - 1-3/8	11-3/8	12-1/2	14-37/64	19-1/16	#4	1/4	2T-4SR	25025H-004I	
m	2	Intermediate	25.0 - 35.0	136.5	165.1	211.2	324.6	#4**	1/8*	2T-3SRM	23020H-004M
		Standard	25.0 - 35.0	187.3	215.9	262.0	375.4	#4**	1/8*	2T-3SRM	24020H-004M
		Extended	25.0 - 35.0	289.0	317.5	363.6	477.0	#4**	1/8*	2T-3SRM	25020H-004M
	2.5	Intermediate	30.0 - 35.0	136.5	165.1	218.4	331.8	#4**	1/4*	2T-4SRM	23025H-004M
		Standard	30.0 - 35.0	187.3	215.9	269.2	382.6	#4**	1/4*	2T-4SRM	24025H-004M
		Extended	30.0 - 35.0	289.0	317.5	370.8	484.2	#4**	1/4*	2T-4SRM	25025H-004M

*Metric thread to BSP and ISO 7-1

**Per ISO 296 type BEK

Connection Accessories

Insert Screws	Nylon Locking Screws	Insert Driver	Preset Torque Hand Driver	Replacement Tips	Admissible Tightening Torque*
7495-IP15-1	7495N-IP15-1	8IP-15	8IP-15TL	8IP-15B	61.0 in-lbs (690 N-cm)

*Tightening torques are calculated with a friction coefficient of $\mu = 0.14$ and develop 90% of ultimate yield strength

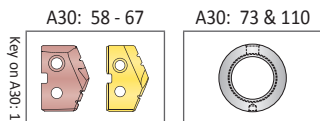

i = Imperial (in)
m = Metric (mm)

Screws sold in quantities of 10

WARNING Refer to Speed and Feed charts for recommended adjustments to speeds and feeds. Refer to page A30: 146 for deep hole drilling guidelines in this section of the catalog. Visit www.alliedmachine.com/DeepHoleGuidelines for the most up-to-date information and procedures. Factory technical assistance is available for your specific applications through our Application Engineering Team.

A DRILLING
B BORING
C REAMING
D BURNISHING
E THREADING
X SPECIALS

T-A Drill Insert Holders

2 Series | Straight Shank

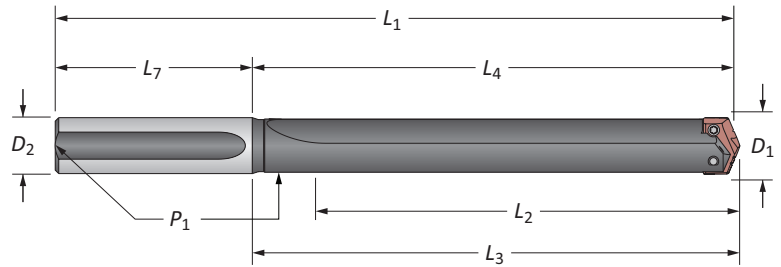

Straight Flute

Series	Length	D_1	Body				Shank			Part No.
			L_2	L_4	L_3	L_1	D_2	L_7	P_1	
2	Short	31/32 - 1-3/8	3-3/8	4-1/2	4-41/64	8	1	3-1/2	1/8	22020S-100L
	Short	31/32 - 1-3/8	3-3/8	4-1/2	4-41/64	8	1-1/4	3-1/2	1/8	22020S-125L
	Intermediate	31/32 - 1-3/8	5-3/8	6-1/2	6-41/64	10	1-1/4	3-1/2	1/8	23020S-125L
	Standard	31/32 - 1-3/8	7-3/8	8-1/2	8-41/64	12	1	3-1/2	1/8	24020S-100L
	Standard	31/32 - 1-3/8	7-3/8	8-1/2	8-41/64	12	1-1/4	3-1/2	1/8	24020S-125L
	Extended	31/32 - 1-3/8	11-3/8	12-1/2	12-41/64	16	1-1/4	3-1/2	1/8	⚠ 25020S-125L
	XL	31/32 - 1-3/8	20-1/8	21-1/4	21-25/64	24-3/4	1-1/4	3-1/2	1/8	⚠ 27020S-125L
3XL	31/32 - 1-3/8	27-1/4	28-3/8	28-33/64	31-7/8	1-1/4	3-1/2	1/8	⚠ 29020S-125L	
2.5	Short	1-3/16 - 1-3/8	3-3/8	4-1/2	4-41/64	8	1	3-1/2	1/8*	22025S-100L
	Short	1-3/16 - 1-3/8	3-3/8	4-1/2	4-41/64	8	1-1/4	3-1/2	1/8*	22025S-125L
	Intermediate	1-3/16 - 1-3/8	5-3/8	6-1/2	6-41/64	10	1-1/4	3-1/2	1/8*	23025S-125L
	Standard	1-3/16 - 1-3/8	7-3/8	8-1/2	8-41/64	12	1	3-1/2	1/8*	24025S-100L
	Standard	1-3/16 - 1-3/8	7-3/8	8-1/2	8-41/64	12	1-1/4	3-1/2	1/8*	24025S-125L
	Extended	1-3/16 - 1-3/8	11-3/8	12-1/2	12-41/64	16	1-1/4	3-1/2	1/8*	⚠ 25025S-125L

Connection Accessories

Insert Screws	Nylon Locking Screws	Insert Driver	Preset Torque Hand Driver	Replacement Tips	Admissible Tightening Torque*
7495-IP15-1	7495N-IP15-1	8IP-15	8IP-15TL	8IP-15B	61.0 in-lbs (690 N-cm)

*Tightening torques are calculated with a friction coefficient of $\mu = 0.14$ and develop 90% of ultimate yield strength

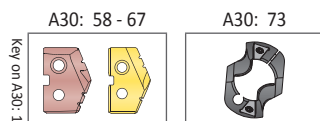

i = Imperial (in)
m = Metric (mm)

Screws sold in quantities of 10

⚠ WARNING Refer to Speed and Feed charts for recommended adjustments to speeds and feeds. Refer to page A30: 146 for deep hole drilling guidelines in this section of the catalog. Visit www.alliedmachine.com/DeepHoleGuidelines for the most up-to-date information and procedures. Factory technical assistance is available for your specific applications through our Application Engineering Team.

T-A Drill Accessories

2 Series | Chamfer Rings | Rotary Coolant Adapters | Torx® Plus Screws

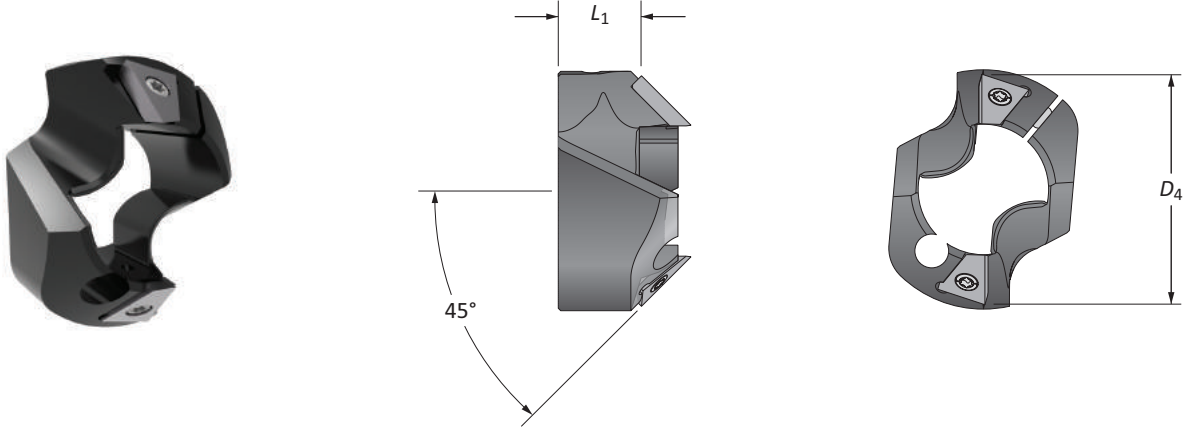

T-ACR 45 Chamfer Ring

Holder Series	D ₁ Range	Chamfer Ring		Part No.	Insert Part No.	Insert Screw	Insert Driver	Clamping Screw	Insert Driver
		D ₄	L ₁						
2	0.9610 - 1.3800	1-9/16	1	T-ACR-45-2	T-ACRI-45-B-C5A	7255-IP8-1	8IP-8	7514-IP20-1	8IP-20

Rotary Coolant Adapter (RCA) and Accessories

ID	OD	L ₁	Driving Rod Thread	P ₁	Part No.	RCA O-Rings		
						Kit Part No.**	Replacements	
i	1	2-1/8	1-1/8	5/16-18	1/8	▲ 2T-3SR	2T1-3SR	2T1-3OR-10
	1-1/4	2-1/2	1-3/8	3/8-16	1/4	▲ 2T-4SR	2T1-4SR	2T1-4OR-10
m	25.40	53.97	28.57	M8 x 1.25	1/8*	▲ 2T-3SRM	2T1-3SR	2T1-3OR-10
	31.75	63.50	34.92	M10 x 1.50	1/4*	▲ 2T-4SRM	2T1-4SR	2T1-4OR-10

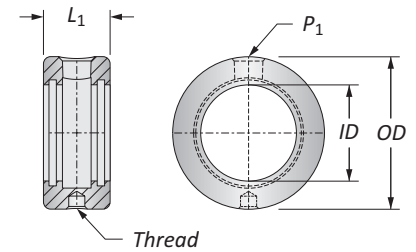

*Thread to BSP and ISO 7-1

**RCA Repair Kit includes (2) O-rings, (2) snap rings, and (2) thrust washers

▲ Refer to page A30: 110 for proper RCA assembly and safety information

Connection Accessories

Insert Screws	Nylon Locking Screws	Insert Driver	Preset Torque Hand Driver	Replacement Tips	Admissible Tightening Torque*
7495-IP15-1	7495N-IP15-1	8IP-15	8IP-15TL	8IP-15B	61.0 in-lbs (690 N-cm)

*Tightening torques are calculated with a friction coefficient of $\mu = 0.14$ and develop 90% of ultimate yield strength

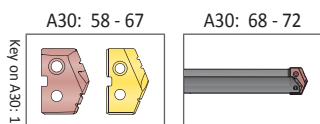

Key on A30: 1

i = Imperial (in)
m = Metric (mm)

Inserts sold separately
Screws sold in packs of 10
O-rings sold in packs of 10

WARNING RCA rotation during drilling can cause hose and/or hose fitting failure, machinery damage, and/or serious injury. To prevent, use RCA and positive stop studs when drilling. Factory technical assistance is also available for your specific applications.



A DRILLING
B BORING
C REAMING
D BURNISHING
E THREADING
X SPECIALS

GEN2 T-A Drill Inserts

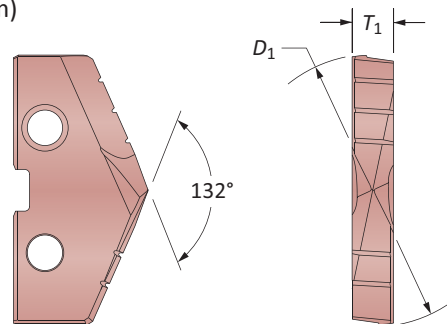
3 Series | HSS | Diameter Range: 1.353" - 1.882" (34.36mm - 47.80mm)

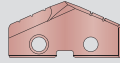

HSS Inserts – Premium Cobalt

Fractional Equivalent	Insert			Part No.	
	D_1 inch	D_1 mm	T_1	 AM200®	 TiN
1-13/32	1.4063	35.72	1/4	483H-0113	483T-0113
-	1.4173	36.00	1/4	483H-36	483T-36
1-7/16	1.4375	36.51	1/4	483H-0114	483T-0114
-	1.4567	37.00	1/4	483H-37	483T-37
1-15/32	1.4688	37.31	1/4	483H-0115	483T-0115
-	1.4961	38.00	1/4	483H-38	483T-38
1-1/2	1.5000	38.10	1/4	483H-0116	483T-0116
1-17/32	1.5313	38.89	1/4	483H-0117	483T-0117
-	1.5354	39.00	1/4	483H-39	483T-39
-	1.5470	39.29	1/4	483H-1.547	483T-1.547
1-9/16	1.5625	39.69	1/4	483H-0118	483T-0118
-	1.5748	40.00	1/4	483H-40	483T-40
1-19/32	1.5938	40.48	1/4	483H-0119	483T-0119
-	1.6142	41.00	1/4	483H-41	483T-41
1-5/8	1.6250	41.28	1/4	483H-0120	483T-0120
-	1.6535	42.00	1/4	483H-42	483T-42
1-21/32	1.6563	42.07	1/4	483H-0121	483T-0121
1-11/16	1.6875	42.86	1/4	483H-0122	483T-0122
-	1.6929	43.00	1/4	483H-43	483T-43
1-23/32	1.7188	43.66	1/4	483H-0123	483T-0123
-	1.7323	44.00	1/4	483H-44	483T-44
1-3/4	1.7500	44.45	1/4	483H-0124	483T-0124
-	1.7717	45.00	1/4	483H-45	483T-45
1-25/32	1.7813	45.24	1/4	483H-0125	483T-0125
-	1.7913	45.50	1/4	483H-45.5	483T-45.5
-	1.7970	45.64	1/4	483H-1.797	483T-1.797
-	1.8110	46.00	1/4	483H-46	483T-46
1-13/16	1.8125	46.04	1/4	483H-0126	483T-0126
1-27/32	1.8438	46.83	1/4	483H-0127	483T-0127
-	1.8504	47.00	1/4	483H-47	483T-47
1-7/8	1.8750	47.63	1/4	483H-0128	483T-0128

A30: 112 - 143

A30: 82 - 85

A30: 4 - 6

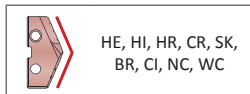
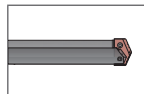
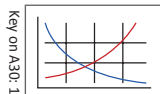

Coatings not listed above can be supplied as non-stocked standards. Process fees apply. →

TiN = 131T-XXXX

TiAlN = 131A-XXXX

TiCN = 131N-XXXX

AM200® = 131H-XXXX

Inserts sold in quantities of 1

GEN2 T-A Drill Inserts

3 Series | HSS | Diameter Range: 1.353" - 1.882" (34.36mm - 47.80mm)

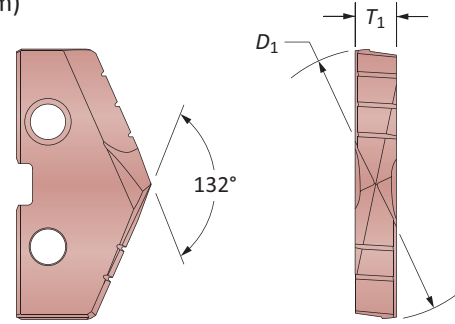

HSS Inserts – Super Cobalt

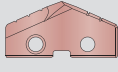
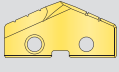
Fractional Equivalent	Insert			Part No.	
	D_1 inch	D_1 mm	T_1	 AM200®	 TiN
1-13/32	1.4063	35.72	1/4	453H-0113	453T-0113
-	1.4173	36.00	1/4	453H-36	453T-36
1-7/16	1.4375	36.51	1/4	453H-0114	453T-0114
-	1.4567	37.00	1/4	453H-37	453T-37
1-15/32	1.4688	37.31	1/4	453H-0115	453T-0115
-	1.4961	38.00	1/4	453H-38	453T-38
1-1/2	1.5000	38.10	1/4	453H-0116	453T-0116
1-17/32	1.5313	38.89	1/4	453H-0117	453T-0117
-	1.5354	39.00	1/4	453H-39	453T-39
-	1.5470	39.29	1/4	453H-1.547	453T-1.547
1-9/16	1.5625	39.69	1/4	453H-0118	453T-0118
-	1.5748	40.00	1/4	453H-40	453T-40
1-19/32	1.5938	40.48	1/4	453H-0119	453T-0119
-	1.6142	41.00	1/4	453H-41	453T-41
1-5/8	1.6250	41.28	1/4	453H-0120	453T-0120
-	1.6535	42.00	1/4	453H-42	453T-42
1-21/32	1.6563	42.07	1/4	453H-0121	453T-0121
1-11/16	1.6875	42.86	1/4	453H-0122	453T-0122
-	1.6929	43.00	1/4	453H-43	453T-43
1-23/32	1.7188	43.66	1/4	453H-0123	453T-0123
-	1.7323	44.00	1/4	453H-44	453T-44
1-3/4	1.7500	44.45	1/4	453H-0124	453T-0124
-	1.7717	45.00	1/4	453H-45	453T-45
1-25/32	1.7813	45.24	1/4	453H-0125	453T-0125
-	1.7913	45.50	1/4	453H-45.5	453T-45.5
-	1.7970	45.64	1/4	453H-1.797	453T-1.797
-	1.8110	46.00	1/4	453H-46	453T-46
1-13/16	1.8125	46.04	1/4	453H-0126	453T-0126
1-27/32	1.8438	46.83	1/4	453H-0127	453T-0127
-	1.8504	47.00	1/4	453H-47	453T-47
1-7/8	1.8750	47.63	1/4	453H-0128	453T-0128

A30: 112 - 143

A30: 82 - 85

A30: 4 - 6

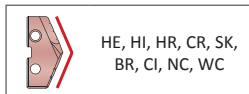
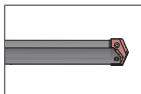
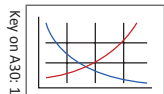

Inserts sold in quantities of 1

Coatings not listed above can be supplied as non-stocked standards. Process fees apply. →

TiN = 131T-XXXX	TiAlN = 131A-XXXX
TiCN = 131N-XXXX	AM200® = 131H-XXXX

GEN2 T-A Drill Inserts

3 Series | HSS | Diameter Range: 1.353" - 1.882" (34.36mm - 47.80mm)

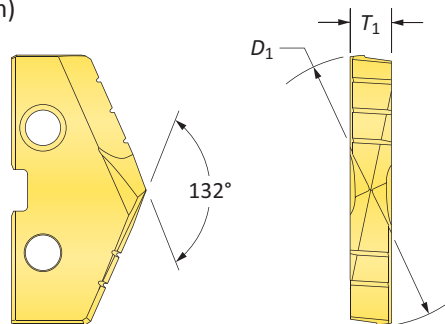
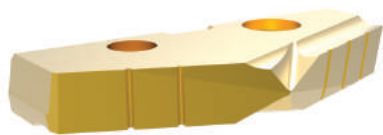

HSS Inserts – Premium Cobalt

Fractional Equivalent	Insert			Part No.
	D_1 inch	D_1 mm	T_1	
1-13/32	1.4063	35.72	1/4	 483T-0113
-	1.4173	36.00	1/4	483T-36
1-7/16	1.4375	36.51	1/4	483T-0114
-	1.4567	37.00	1/4	483T-37
1-15/32	1.4688	37.31	1/4	483T-0115
-	1.4961	38.00	1/4	483T-38
1-1/2	1.5000	38.10	1/4	483T-0116
1-17/32	1.5313	38.89	1/4	483T-0117
-	1.5354	39.00	1/4	483T-39
-	1.5470	39.29	1/4	483T-1.547
1-9/16	1.5625	39.69	1/4	483T-0118
-	1.5748	40.00	1/4	483T-40
1-19/32	1.5938	40.48	1/4	483T-0119
-	1.6142	41.00	1/4	483T-41
1-5/8	1.6250	41.28	1/4	483T-0120
-	1.6535	42.00	1/4	483T-42
1-21/32	1.6563	42.07	1/4	483T-0121
1-11/16	1.6875	42.86	1/4	483T-0122
-	1.6929	43.00	1/4	483T-43
1-23/32	1.7188	43.66	1/4	483T-0123
-	1.7323	44.00	1/4	483T-44
1-3/4	1.7500	44.45	1/4	483T-0124
-	1.7717	45.00	1/4	483T-45
1-25/32	1.7813	45.24	1/4	483T-0125
-	1.7913	45.50	1/4	483T-45.5
-	1.7970	45.64	1/4	483T-1.797
-	1.8110	46.00	1/4	483T-46
1-13/16	1.8125	46.04	1/4	483T-0126
1-27/32	1.8438	46.83	1/4	483T-0127
-	1.8504	47.00	1/4	483T-47
1-7/8	1.8750	47.63	1/4	483T-0128

Inserts sold in quantities of 1

A30: 112 - 143

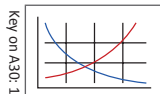

A30: 82 - 85

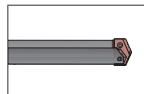

A30: 4 - 6

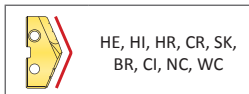

Coatings not listed above
can be supplied as
non-stocked standards.
Process fees apply. →

TiN = 131T-XXXX

TiAlN = 131A-XXXX

TiCN = 131N-XXXX

AM200® = 131H-XXXX

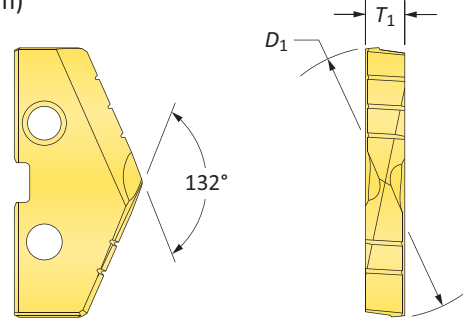
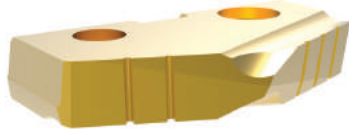

Original T-A Drill Inserts

3 Series | HSS | Diameter Range: 1.353" - 1.882" (34.36mm - 47.80mm)

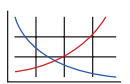

HSS Inserts – Super Cobalt

Fractional Equivalent	Insert			Part No.
	D ₁ inch	D ₁ mm	T ₁	
1-13/32	1.4063	35.72	1/4	153T-0113
-	1.4173	36.00	1/4	153T-36
1-7/16	1.4375	36.51	1/4	153T-0114
-	1.4567	37.00	1/4	153T-37
1-15/32	1.4688	37.31	1/4	153T-0115
-	1.4961	38.00	1/4	153T-38
1-1/2	1.5000	38.10	1/4	153T-0116
1-17/32	1.5313	38.89	1/4	153T-0117
-	1.5354	39.00	1/4	153T-39
-	1.5470	39.29	1/4	153T-1.547
1-9/16	1.5625	39.69	1/4	153T-0118
-	1.5748	40.00	1/4	153T-40
1-19/32	1.5938	40.48	1/4	153T-0119
-	1.6142	41.00	1/4	153T-41
1-5/8	1.6250	41.28	1/4	153T-0120
-	1.6535	42.00	1/4	153T-42
1-21/32	1.6563	42.07	1/4	153T-0121
1-11/16	1.6875	42.86	1/4	153T-0122
-	1.6929	43.00	1/4	153T-43
1-23/32	1.7188	43.66	1/4	153T-0123
-	1.7323	44.00	1/4	153T-44
1-3/4	1.7500	44.45	1/4	153T-0124
-	1.7717	45.00	1/4	153T-45
1-25/32	1.7813	45.24	1/4	153T-0125
-	1.7913	45.50	1/4	153T-45.5
-	1.7970	45.64	1/4	153T-1.797
-	1.8110	46.00	1/4	153T-46
1-13/16	1.8125	46.04	1/4	153T-0126
1-27/32	1.8438	46.83	1/4	153T-0127
-	1.8504	47.00	1/4	153T-47
1-7/8	1.8750	47.63	1/4	153T-0128

A30: 112 - 143  A30: 82 - 85  A30: 4 - 6  HI, HR, CR, SK, BR, CI, NC, WC

Coatings not listed above can be supplied as non-stocked standards. Process fees apply. 

Inserts sold in quantities of 1

TiN = 131T-XXXX	TiAlN = 131A-XXXX
TiCN = 131N-XXXX	AM200® = 131H-XXXX

Original T-A Drill Inserts



3 Series | HSS | Diameter Range: 1.353" - 1.882" (34.36mm - 47.80mm)

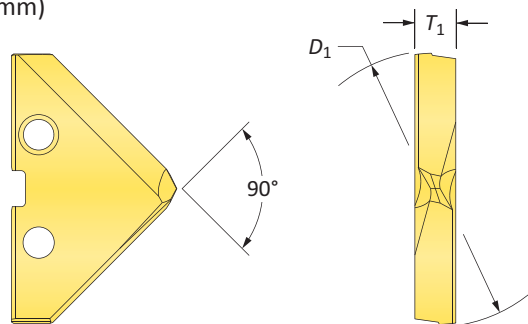

90° Spot & Chamfer



HSS Inserts – Super Cobalt

Fractional Equivalent	Insert			Part No.		
	D_1 inch	D_1 mm	T_1	 TiN	 TiAlN	 TiCN
1-13/32	1.4063	35.72	1/4	153T-0113-SP	153A-0113-SP	153N-0113-SP
-	1.4173	36.00	1/4	153T-36-SP	153A-36-SP	153N-36-SP
1-7/16	1.4375	36.51	1/4	153T-0114-SP	153A-0114-SP	153N-0114-SP
-	1.4567	37.00	1/4	153T-37-SP	153A-37-SP	153N-37-SP
1-15/32	1.4688	37.31	1/4	153T-0115-SP	153A-0115-SP	153N-0115-SP
-	1.4961	38.00	1/4	153T-38-SP	153A-38-SP	153N-38-SP
1-1/2	1.5000	38.10	1/4	153T-0116-SP	153A-0116-SP	153N-0116-SP
1-17/32	1.5313	38.89	1/4	153T-0117-SP	153A-0117-SP	153N-0117-SP
-	1.5354	39.00	1/4	153T-39-SP	153A-39-SP	153N-39-SP
-	1.5470	39.29	1/4	153T-1.547-SP	153A-1.547-SP	153N-1.547-SP
1-9/16	1.5625	39.69	1/4	153T-0118-SP	153A-0118-SP	153N-0118-SP
-	1.5748	40.00	1/4	153T-40-SP	153A-40-SP	153N-40-SP
1-19/32	1.5938	40.48	1/4	153T-0119-SP	153A-0119-SP	153N-0119-SP
-	1.6142	41.00	1/4	153T-41-SP	153A-41-SP	153N-41-SP
1-5/8	1.6250	41.28	1/4	153T-0120-SP	153A-0120-SP	153N-0120-SP
-	1.6535	42.00	1/4	153T-42-SP	153A-42-SP	153N-42-SP
1-21/32	1.6563	42.07	1/4	153T-0121-SP	153A-0121-SP	153N-0121-SP
1-11/16	1.6875	42.86	1/4	153T-0122-SP	153A-0122-SP	153N-0122-SP
-	1.6929	43.00	1/4	153T-43-SP	153A-43-SP	153N-43-SP
1-23/32	1.7188	43.66	1/4	153T-0123-SP	153A-0123-SP	153N-0123-SP
-	1.7323	44.00	1/4	153T-44-SP	153A-44-SP	153N-44-SP
1-3/4	1.7500	44.45	1/4	153T-0124-SP	153A-0124-SP	153N-0124-SP
-	1.7717	45.00	1/4	153T-45-SP	153A-45-SP	153N-45-SP
1-25/32	1.7813	45.24	1/4	153T-0125-SP	153A-0125-SP	153N-0125-SP
-	1.7913	45.50	1/4	153T-45.5-SP	153A-45.5-SP	153N-45.5-SP
-	1.7970	45.64	1/4	153T-1.797-SP	153A-1.797-SP	153N-1.797-SP
-	1.8110	46.00	1/4	153T-46-SP	153A-46-SP	153N-46-SP
1-13/16	1.8125	46.04	1/4	153T-0126-SP	153A-0126-SP	153N-0126-SP
1-27/32	1.8438	46.83	1/4	153T-0127-SP	153A-0127-SP	153N-0127-SP
-	1.8504	47.00	1/4	153T-47-SP	153A-47-SP	153N-47-SP
1-7/8	1.8750	47.63	1/4	153T-0128-SP	153A-0128-SP	153N-0128-SP

Inserts sold in quantities of 1

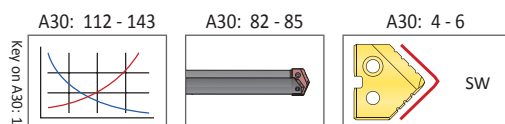

Coatings not listed above can be supplied as non-stocked standards. Process fees apply. →

TiN = 131T-XXXX	TiAlN = 131A-XXXX
TiCN = 131N-XXXX	AM200® = 131H-XXXX



Original T-A Drill Inserts

3 Series | HSS | Diameter Range: 1.353" - 1.882" (34.36mm - 47.80mm)

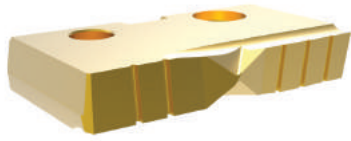

Flat Bottom

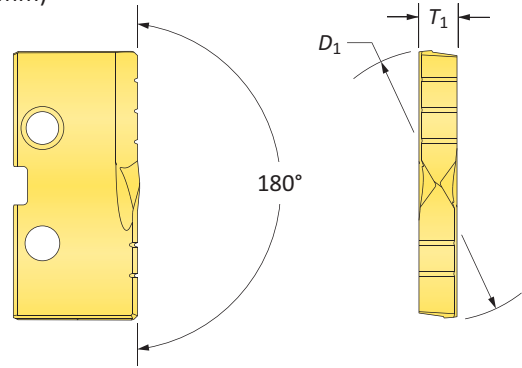

HSS Inserts – Super Cobalt

Fractional Equivalent	Insert			Part No.
	D ₁ inch	D ₁ mm	T ₁	
1-13/32	1.4063	35.72	1/4	153T-0113-FB
-	1.4173	36.00	1/4	153T-36-FB
1-7/16	1.4375	36.51	1/4	153T-0114-FB
-	1.4567	37.00	1/4	153T-37-FB
1-15/32	1.4688	37.31	1/4	153T-0115-FB
-	1.4961	38.00	1/4	153T-38-FB
1-1/2	1.5000	38.10	1/4	153T-0116-FB
1-17/32	1.5313	38.89	1/4	153T-0117-FB
-	1.5354	39.00	1/4	153T-39-FB
-	1.5470	39.29	1/4	153T-1.547-FB
1-9/16	1.5625	39.69	1/4	153T-0118-FB
-	1.5748	40.00	1/4	153T-40-FB
1-19/32	1.5938	40.48	1/4	153T-0119-FB
-	1.6142	41.00	1/4	153T-41-FB
1-5/8	1.6250	41.28	1/4	153T-0120-FB
-	1.6535	42.00	1/4	153T-42-FB
1-21/32	1.6563	42.07	1/4	153T-0121-FB
1-11/16	1.6875	42.86	1/4	153T-0122-FB
-	1.6929	43.00	1/4	153T-43-FB
1-23/32	1.7188	43.66	1/4	153T-0123-FB
-	1.7323	44.00	1/4	153T-44-FB
1-3/4	1.7500	44.45	1/4	153T-0124-FB
-	1.7717	45.00	1/4	153T-45-FB
1-25/32	1.7813	45.24	1/4	153T-0125-FB
-	1.7913	45.50	1/4	153T-45.5-FB
-	1.7970	45.64	1/4	153T-1.797-FB
-	1.8110	46.00	1/4	153T-46-FB
1-13/16	1.8125	46.04	1/4	153T-0126-FB
1-27/32	1.8438	46.83	1/4	153T-0127-FB
-	1.8504	47.00	1/4	153T-47-FB
1-7/8	1.8750	47.63	1/4	153T-0128-FB

Key on A30-1

A30: 112 - 143

A30: 82 - 85

A30: 4 - 6

Coatings not listed above can be supplied as non-stocked standards. Process fees apply. →

TiN = 131T-XXXX	TiAlN = 131A-XXXX
TiCN = 131N-XXXX	AM200® = 131H-XXXX

Inserts sold in quantities of 1

Original T-A Drill Inserts

3 Series | Carbide | Diameter Range: 1.353" - 1.882" (34.36mm - 47.80mm)

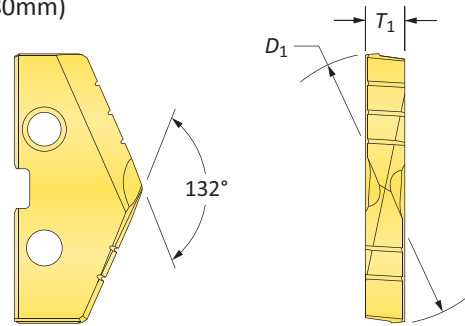
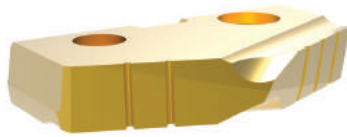

Carbide Inserts – C2 (K20)

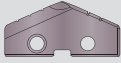
Fractional Equivalent	Insert			Part No.	
	D_1 inch	D_1 mm	T_1	 TiN	 TiAlN
1-13/32	1.4063	35.72	1/4	1C23T-0113	1C23A-0113
-	1.4173	36.00	1/4	1C23T-36	1C23A-36
1-7/16	1.4375	36.51	1/4	1C23T-0114	1C23A-0114
-	1.4567	37.00	1/4	1C23T-37	1C23A-37
1-15/32	1.4688	37.31	1/4	1C23T-0115	1C23A-0115
-	1.4961	38.00	1/4	1C23T-38	1C23A-38
1-1/2	1.5000	38.10	1/4	1C23T-0116	1C23A-0116
1-17/32	1.5313	38.89	1/4	1C23T-0117	1C23A-0117
-	1.5354	39.00	1/4	1C23T-39	1C23A-39
-	1.5470	39.29	1/4	1C23T-1.547	1C23A-1.547
1-9/16	1.5625	39.69	1/4	1C23T-0118	1C23A-0118
-	1.5748	40.00	1/4	1C23T-40	1C23A-40
1-19/32	1.5938	40.48	1/4	1C23T-0119	1C23A-0119
-	1.6142	41.00	1/4	1C23T-41	1C23A-41
1-5/8	1.6250	41.28	1/4	1C23T-0120	1C23A-0120
-	1.6535	42.00	1/4	1C23T-42	1C23A-42
1-21/32	1.6563	42.07	1/4	1C23T-0121	1C23A-0121
1-11/16	1.6875	42.86	1/4	1C23T-0122	1C23A-0122
-	1.6929	43.00	1/4	1C23T-43	1C23A-43
1-23/32	1.7188	43.66	1/4	1C23T-0123	1C23A-0123
-	1.7323	44.00	1/4	1C23T-44	1C23A-44
1-3/4	1.7500	44.45	1/4	1C23T-0124	1C23A-0124
-	1.7717	45.00	1/4	1C23T-45	1C23A-45
1-25/32	1.7813	45.24	1/4	1C23T-0125	1C23A-0125
-	1.7913	45.50	1/4	1C23T-45.5	1C23A-45.5
-	1.7970	45.64	1/4	1C23T-1.797	1C23A-1.797
-	1.8110	46.00	1/4	1C23T-46	1C23A-46
1-13/16	1.8125	46.04	1/4	1C23T-0126	1C23A-0126
1-27/32	1.8438	46.83	1/4	1C23T-0127	1C23A-0127
-	1.8504	47.00	1/4	1C23T-47	1C23A-47
1-7/8	1.8750	47.63	1/4	1C23T-0128	1C23A-0128

Inserts sold in quantities of 1

A30: 112 - 143

A30: 82 - 85

A30: 4 - 6

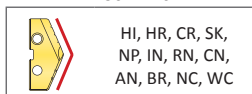
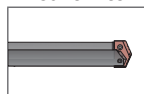
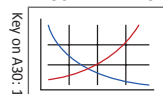

Coatings not listed above can be supplied as non-stocked standards. Process fees apply. →



TiN = 131T-XXXX	TiAlN = 131A-XXXX
TiCN = 131N-XXXX	AM200® = 131H-XXXX

Original T-A Drill Inserts

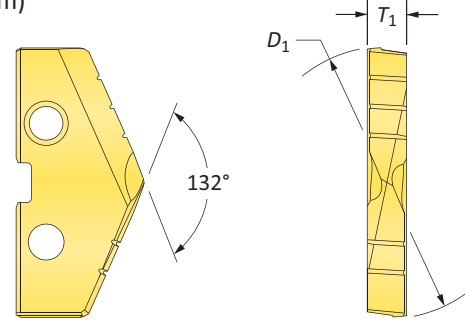
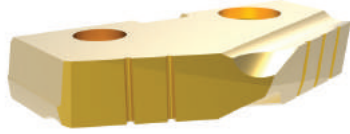
3 Series | HSS | Diameter Range: 1.353" - 1.882" (34.36mm - 47.80mm)

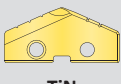

Carbide Inserts – C5 (P40)

Fractional Equivalent	Insert			Part No.	
	D_1 inch	D_1 mm	T_1	 TiN	 TiAlN
1-13/32	1.4063	35.72	1/4	1C53T-0113	1C53A-0113
-	1.4173	36.00	1/4	1C53T-36	1C53A-36
1-7/16	1.4375	36.51	1/4	1C53T-0114	1C53A-0114
-	1.4567	37.00	1/4	1C53T-37	1C53A-37
1-15/32	1.4688	37.31	1/4	1C53T-0115	1C53A-0115
-	1.4961	38.00	1/4	1C53T-38	1C53A-38
1-1/2	1.5000	38.10	1/4	1C53T-0116	1C53A-0116
1-17/32	1.5313	38.89	1/4	1C53T-0117	1C53A-0117
-	1.5354	39.00	1/4	1C53T-39	1C53A-39
-	1.5470	39.29	1/4	1C53T-1.547	1C53A-1.547
1-9/16	1.5625	39.69	1/4	1C53T-0118	1C53A-0118
-	1.5748	40.00	1/4	1C53T-40	1C53A-40
1-19/32	1.5938	40.48	1/4	1C53T-0119	1C53A-0119
-	1.6142	41.00	1/4	1C53T-41	1C53A-41
1-5/8	1.6250	41.28	1/4	1C53T-0120	1C53A-0120
-	1.6535	42.00	1/4	1C53T-42	1C53A-42
1-21/32	1.6563	42.07	1/4	1C53T-0121	1C53A-0121
1-11/16	1.6875	42.86	1/4	1C53T-0122	1C53A-0122
-	1.6929	43.00	1/4	1C53T-43	1C53A-43
1-23/32	1.7188	43.66	1/4	1C53T-0123	1C53A-0123
-	1.7323	44.00	1/4	1C53T-44	1C53A-44
1-3/4	1.7500	44.45	1/4	1C53T-0124	1C53A-0124
-	1.7717	45.00	1/4	1C53T-45	1C53A-45
1-25/32	1.7813	45.24	1/4	1C53T-0125	1C53A-0125
-	1.7913	45.50	1/4	1C53T-45.5	1C53A-45.5
-	1.7970	45.64	1/4	1C53T-1.797	1C53A-1.797
-	1.8110	46.00	1/4	1C53T-46	1C53A-46
1-13/16	1.8125	46.04	1/4	1C53T-0126	1C53A-0126
1-27/32	1.8438	46.83	1/4	1C53T-0127	1C53A-0127
-	1.8504	47.00	1/4	1C53T-47	1C53A-47
1-7/8	1.8750	47.63	1/4	1C53T-0128	1C53A-0128

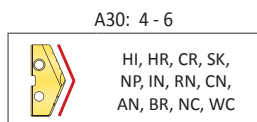
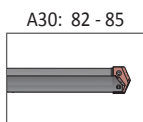
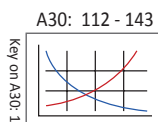

Inserts sold in quantities of 1

Coatings not listed above can be supplied as non-stocked standards. Process fees apply. →

TiN = 131T-XXXX	TiAlN = 131A-XXXX
TiCN = 131N-XXXX	AM200® = 131H-XXXX

T-A Drill Insert Holders

3 Series | Flange Shank

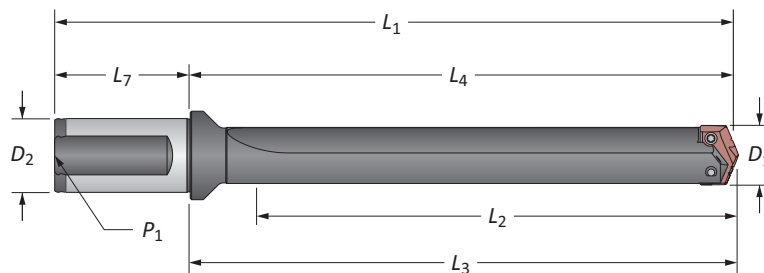

Stub Length

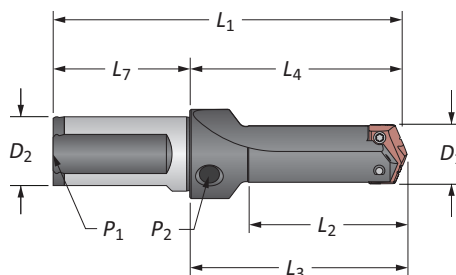

Straight Flute

Length	D ₁	Body				Shank			Part No.
		L ₂	L ₄	L ₃	L ₁	D ₂	L ₇	P ₁	
Stub	1-13/32 - 1-7/8	3	4-59/64	5-7/64	7-39/64	1-1/2	2-11/16	1/4	21030S-150F
Short	1-13/32 - 1-7/8	4-3/4	6-13/16	7	9-1/2	1-1/2	2-11/16	1/4	22030S-150F
Intermediate	1-13/32 - 1-7/8	6-1/2	8-9/16	8-3/4	11-1/4	1-1/2	2-11/16	1/4	23030S-150F
Standard	1-13/32 - 1-7/8	8-1/4	10-5/16	10-1/2	13	1-1/2	2-11/16	1/4	24030S-150F
Stub	36.0 - 47.0	76.2	125.0	129.8	195.0	40.0	70.0	1/4*	21030S-40FM
Short	36.0 - 47.0	120.7	173.0	177.8	243.0	40.0	70.0	1/4*	22030S-40FM
Extended	36.0 - 47.0	349.3	401.6	406.4	471.6	40.0	70.0	1/4*	25030S-40FM
XL	36.0 - 47.0	558.8	611.1	615.9	681.1	40.0	70.0	1/4*	27030S-40FM
3XL	36.0 - 47.0	787.4	839.7	844.5	909.7	40.0	70.0	1/4*	29030S-40FM

*Metric thread to BSP and ISO 7-1

NOTE: Stub length holders have a 1/4" side pipe tap (P₂)

Connection Accessories

Insert Screws	Nylon Locking Screws	Insert Driver	Preset Torque Hand Driver	Replacement Tips	Admissible Tightening Torque*
7514-IP20-1	7514N-IP20-1	8IP-20	8IP-20TL	8IP-20B	121.3 in-lbs (1370 N-cm)

*Tightening torques are calculated with a friction coefficient of $\mu = 0.14$ and develop 90% of ultimate yield strength

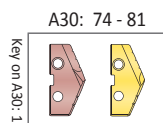

i = Imperial (in)

m = Metric (mm)

Screws sold in quantities of 10

WARNING Refer to Speed and Feed charts for recommended adjustments to speeds and feeds. Refer to page A30: 146 for deep hole drilling guidelines in this section of the catalog. Visit www.alliedmachine.com/DeepHoleGuidelines for the most up-to-date information and procedures. Factory technical assistance is available for your specific applications through our Application Engineering Team.



T-A Drill Insert Holders

3 Series | Flange Shank

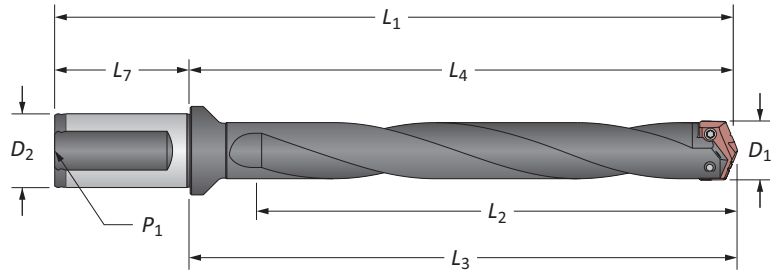

Helical Flute

Length	D ₁	Body				Shank			Part No.	
		L ₂	L ₄	L ₃	L ₁	D ₂	L ₇	P ₁		
i	Intermediate	1-13/32 - 1-7/8	6-1/2	8-9/16	8-3/4	11-1/4	1-1/2	2-11/16	1/4	23030H-150F
	Standard	1-13/32 - 1-7/8	8-1/4	10-5/16	10-1/2	13	1-1/2	2-11/16	1/4	24030H-150F
m	Intermediate	25.0 - 35.0	165.1	217.5	222.3	287.5	40.0	70.0	1/4*	23030H-40FM
	Standard	25.0 - 35.0	209.6	261.9	266.7	331.9	40.0	70.0	1/4*	24030H-40FM

*Metric thread to BSP and ISO 7-1

Connection Accessories

					Admissible Tightening Torque*
7514-IP20-1	7514N-IP20-1	8IP-20	8IP-20TL	8IP-20B	

*Tightening torques are calculated with a friction coefficient of $\mu = 0.14$ and develop 90% of ultimate yield strength

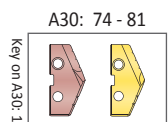

i = Imperial (in)
m = Metric (mm)

Screws sold in quantities of 10

T-A Drill Insert Holders

3 Series | Taper Shank

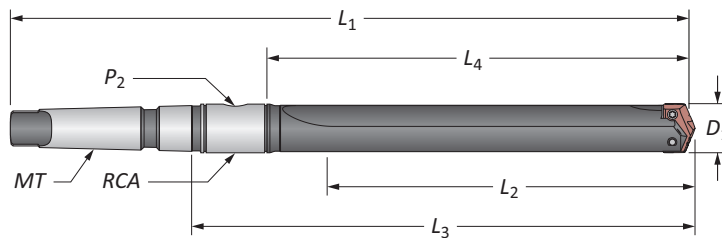

Straight Flute

	Length	D_1	Body				Shank			Part No.
			L_2	L_3	L_4	L_1	MT	P_2	RCA	
i	Short	1-13/32 - 1-7/8	4-3/4	6	8-1/8	12-9/16	#4	1/4	2T-4SR	22030S-004I
	Short	1-13/32 - 1-7/8	4-3/4	6	8-1/8	13-13/16	#5	1/4	2T-5SR	22030S-005I
	Intermediate	1-13/32 - 1-7/8	6-1/2	7-3/4	9-7/8	14-5/16	#4	1/4	2T-4SR	23030S-004I
	Standard	1-13/32 - 1-7/8	8-1/4	9-1/2	11-5/8	16-1/16	#4	1/4	2T-4SR	24030S-004I
	Standard	1-13/32 - 1-7/8	8-1/4	9-1/2	11-5/8	17-5/16	#5	1/4	2T-5SR	24030S-005I
	Extended	1-13/32 - 1-7/8	13-3/4	15	17-1/8	21-9/16	#4	1/4	2T-4SR	25030S-004I
	XL	1-13/32 - 1-7/8	22	22-1/4	25-3/8	29-13/16	#4	1/4	2T-4SR	27030S-004I
	3XL	1-13/32 - 1-7/8	31	32-1/4	34-3/8	38-13/16	#4	1/4	2T-4SR	29030S-004I
m	Short	36.0 - 47.0	120.6	152.4	206.4	319.1	#4**	1/4*	2T-4SRM	22030S-004M
	Extended	36.0 - 47.0	349.3	381.0	435.0	547.7	#4**	1/4*	2T-4SRM	25030S-004M
	XL	36.0 - 47.0	558.8	590.6	644.6	757.2	#4**	1/4*	2T-4SRM	27030S-004M
	3XL	36.0 - 47.0	787.4	819.2	873.2	985.8	#4**	1/4*	2T-4SRM	29030S-004M

*Metric thread to BSP and ISO 7-1

**Per ISO 296 type BEK

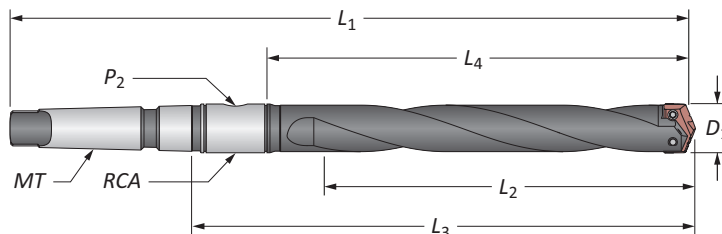

Helical Flute

	Length	D_1	Body				Shank			Part No.
			L_2	L_3	L_4	L_1	MT	P_2	RCA	
m	Intermediate	36.0 - 47.0	165.1	196.9	250.9	363.6	#4**	1/4*	2T-4SRM	23030H-004M
	Standard	36.0 - 47.0	209.5	241.3	295.3	408.0	#4**	1/4*	2T-4SRM	24030H-004M

*Metric thread to BSP and ISO 7-1 | **Per ISO 296 type BEK

Connection Accessories

Insert Screws	Nylon Locking Screws	Insert Driver	Preset Torque Hand Driver	Replacement Tips	Admissible Tightening Torque*
7514-IP20-1	7514N-IP20-1	8IP-20	8IP-20TL	8IP-20B	121.3 in-lbs (1370 N-cm)

*Tightening torques are calculated with a friction coefficient of $\mu = 0.14$ and develop 90% of ultimate yield strength

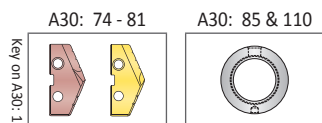

i = Imperial (in)

m = Metric (mm)

Screws sold in quantities of 10

WARNING Refer to Speed and Feed charts for recommended adjustments to speeds and feeds. Refer to page A30: 146 for deep hole drilling guidelines in this section of the catalog. Visit www.alliedmachine.com/DeepHoleGuidelines for the most up-to-date information and procedures. Factory technical assistance is available for your specific applications through our Application Engineering Team.

T-A Drill Insert Holders

3 Series | Straight Shank

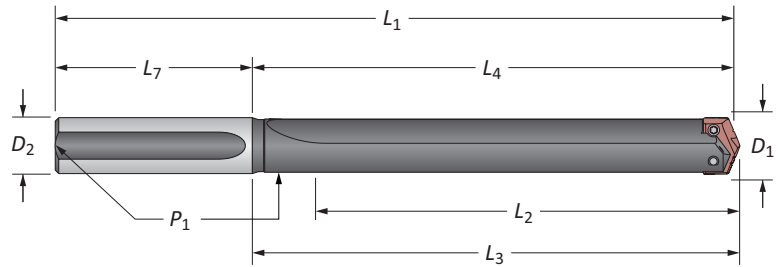

Straight Flute

Length	D ₁	Body				Shank			Part No.
		L ₂	L ₄	L ₃	L ₁	D ₂	L ₇	P ₁	
Short	1-13/32 - 1-7/8	4-3/4	6	6-3/16	10	1-1/4	4	1/4	22030S-125L
Short	1-13/32 - 1-7/8	4-3/4	6	6-3/16	10	1-1/2	4	1/4	22030S-150L
Intermediate	1-13/32 - 1-7/8	6-1/2	7-3/4	7-15/16	11-3/4	1-1/2	4	1/4	23030S-150L
Standard	1-13/32 - 1-7/8	8-1/4	9-1/2	9-11/16	13-1/2	1-1/4	4	1/4	24030S-125L
Standard	1-13/32 - 1-7/8	8-1/4	9-1/2	9-11/16	13-1/2	1-1/2	4	1/4	24030S-150L
Extended	1-13/32 - 1-7/8	13-3/4	15-3/16	15-3/16	19	1-1/4	4	1/4	25030S-125L
XL	1-13/32 - 1-7/8	22	23-7/16	23-7/16	27-1/4	1-1/2	4	1/4	27030S-150L
3XL	1-13/32 - 1-7/8	31	32-7/16	32-7/16	36-1/4	1-1/2	4	1/4	29030S-150L

T-A Drill Accessories

3 Series | Rotary Coolant Adapters | Torx® Plus Screws

Rotary Coolant Adapter (RCA) and Accessories

ID	OD	L ₁	Driving Rod Thread	P ₁	Part No.	RCA O-Rings	
						Kit Part No.**	Replacements
1-1/4	2-1/2	1-3/8	3/8-16	1/4	2T-4SR	2T1-4SR	2T1-4OR-10
1-3/4	3	1-3/8	3/8-16	1/4	2T-5SR	2T1-5SR	2T1-5OR-10
31.75	63.50	34.92	M10 x 1.50	1/4*	2T-4SRM	2T1-4SR	2T1-4OR-10
44.45	76.20	34.92	M10 x 1.50	1/4*	2T-5SRM	2T1-5SR	2T1-5OR-10

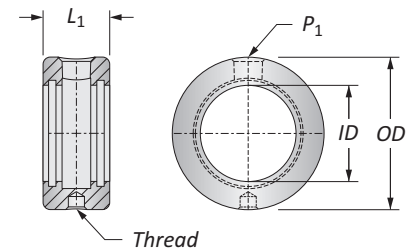

*Thread to BSP and ISO 7-1

**RCA Repair Kit includes (2) O-rings, (2) snap rings, and (2) thrust washers

Refer to page A30: 110 for proper RCA assembly and safety information

Connection Accessories

Insert Screws	Nylon Locking Screws	Insert Driver	Preset Torque Hand Driver	Replacement Tips	Admissible Tightening Torque*
7514-IP20-1	7514N-IP20-1	8IP-20	8IP-20TL	8IP-20B	121.3 in-lbs (1370 N-cm)

*Tightening torques are calculated with a friction coefficient of $\mu = 0.14$ and develop 90% of ultimate yield strength

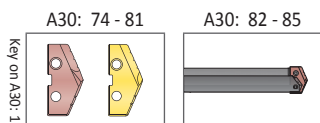

ⓘ = Imperial (in)

Ⓜ = Metric (mm)

Inserts sold separately
Screws sold in packs of 10
O-rings sold in packs of 10



WARNING Refer to Speed and Feed charts for recommended adjustments to speeds and feeds. Refer to page A30: 146 for deep hole drilling guidelines in this section of the catalog. Visit www.alliedmachine.com/DeepHoleGuidelines for the most up-to-date information and procedures. Factory technical assistance is available for your specific applications through our Application Engineering Team.

GEN2 T-A Drill Inserts

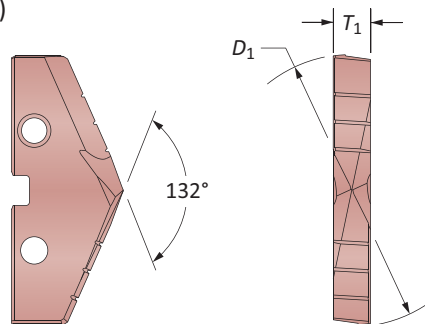
4 Series | HSS | Diameter Range: 1.850" - 2.570" (46.99mm - 65.28mm)

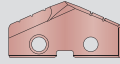

HSS Inserts – Super Cobalt

Fractional Equivalent	Insert			Part No.	
	D_1 inch	D_1 mm	T_1	 AM200®	 TiN
–	1.8898	48.00	5/16	454H-48	454T-48
1-29/32	1.9063	48.42	5/16	454H-0129	454T-0129
–	1.9291	49.00	5/16	454H-49	454T-49
1-15/16	1.9375	49.21	5/16	454H-0130	454T-0130
–	1.9685	50.00	5/16	454H-50	454T-50
1-31/32	1.9688	50.01	5/16	454H-0131	454T-0131
2	2.0000	50.80	5/16	454H-0200	454T-0200
–	2.0079	51.00	5/16	454H-51	454T-51
2-1/32	2.0313	51.59	5/16	454H-0201	454T-0201
2-3/64	2.0472	52.00	5/16	454H-52	454T-52
2-1/16	2.0625	52.39	5/16	454H-0202	454T-0202
–	2.0866	53.00	5/16	454H-53	454T-53
2-3/32	2.0938	53.18	5/16	454H-0203	454T-0203
2-1/8	2.1250	53.98	5/16	454H-0204	454T-0204
–	2.1260	54.00	5/16	454H-54	454T-54
2-5/32	2.1563	54.77	5/16	454H-0205	454T-0205
–	2.1654	55.00	5/16	454H-55	454T-55
2-3/16	2.1875	55.56	5/16	454H-0206	454T-0206
–	2.2047	56.00	5/16	454H-56	454T-56
2-7/32	2.2188	56.36	5/16	454H-0207	454T-0207
–	2.2441	57.00	5/16	454H-57	454T-57
2-1/4	2.2500	57.15	5/16	454H-0208	454T-0208
2-9/32	2.2813	57.94	5/16	454H-0209	454T-0209
–	2.2835	58.00	5/16	454H-58	454T-58
2-5/16	2.3125	58.74	5/16	454H-0210	454T-0210
–	2.3228	59.00	5/16	454H-59	454T-59
2-11/32	2.3438	59.53	5/16	454H-0211	454T-0211
–	2.3622	60.00	5/16	454H-60	454T-60
2-3/8	2.3750	60.33	5/16	454H-0212	454T-0212
–	2.4016	61.00	5/16	454H-61	454T-61
2-13/32	2.4063	61.12	5/16	454H-0213	454T-0213
2-7/16	2.4375	61.91	5/16	454H-0214	454T-0214
–	2.4409	62.00	5/16	454H-62	454T-62
2-15/32	2.4688	62.71	5/16	454H-0215	454T-0215
–	2.4803	63.00	5/16	454H-63	454T-63
2-1/2	2.5000	63.50	5/16	454H-0216	454T-0216
–	2.5197	64.00	5/16	454H-64	454T-64
2-17/32	2.5313	64.29	5/16	454H-0217	454T-0217
–	2.5591	65.00	5/16	454H-65	454T-65
2-9/16	2.5625	65.09	5/16	454H-0218	454T-0218

Inserts sold in quantities of 1

A30: 112 - 143

A30: 90 - 92

A30: 4 - 6

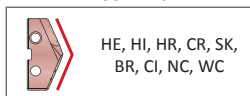
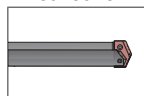
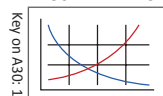

Coatings not listed above can be supplied as non-stocked standards. Process fees apply. →

TiN = 131T-XXXX	TiAlN = 131A-XXXX
TiCN = 131N-XXXX	AM200® = 131H-XXXX



GEN2 T-A Drill Inserts

4 Series | HSS | Diameter Range: 1.850" - 2.570" (46.99mm - 65.28mm)

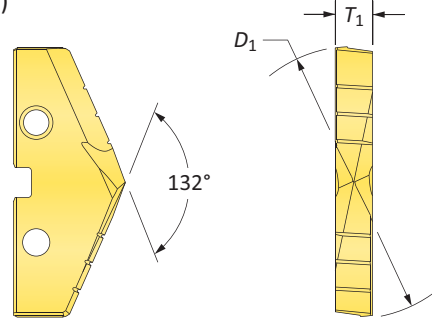

HSS Inserts – HSS

Fractional Equivalent	Insert			Part No.
	D ₁ inch	D ₁ mm	T ₁	
-	1.8898	48.00	5/16	434T-48
1-29/32	1.9063	48.42	5/16	434T-0129
-	1.9291	49.00	5/16	434T-49
1-15/16	1.9375	49.21	5/16	434T-0130
-	1.9685	50.00	5/16	434T-50
1-31/32	1.9688	50.01	5/16	434T-0131
2	2.0000	50.80	5/16	434T-0200
-	2.0079	51.00	5/16	434T-51
2-1/32	2.0313	51.59	5/16	434T-0201
2-3/64	2.0472	52.00	5/16	434T-52
2-1/16	2.0625	52.39	5/16	434T-0202
-	2.0866	53.00	5/16	434T-53
2-3/32	2.0938	53.18	5/16	434T-0203
2-1/8	2.1250	53.98	5/16	434T-0204
-	2.1260	54.00	5/16	434T-54
2-5/32	2.1563	54.77	5/16	434T-0205
-	2.1654	55.00	5/16	434T-55
2-3/16	2.1875	55.56	5/16	434T-0206
-	2.2047	56.00	5/16	434T-56
2-7/32	2.2188	56.36	5/16	434T-0207
-	2.2441	57.00	5/16	434T-57
2-1/4	2.2500	57.15	5/16	434T-0208
2-9/32	2.2813	57.94	5/16	434T-0209
-	2.2835	58.00	5/16	434T-58
2-5/16	2.3125	58.74	5/16	434T-0210
-	2.3228	59.00	5/16	434T-59
2-11/32	2.3438	59.53	5/16	434T-0211
-	2.3622	60.00	5/16	434T-60
2-3/8	2.3750	60.33	5/16	434T-0212
-	2.4016	61.00	5/16	434T-61
2-13/32	2.4063	61.12	5/16	434T-0213
2-7/16	2.4375	61.91	5/16	434T-0214
-	2.4409	62.00	5/16	434T-62
2-15/32	2.4688	62.71	5/16	434T-0215
-	2.4803	63.00	5/16	434T-63
2-1/2	2.5000	63.50	5/16	434T-0216
-	2.5197	64.00	5/16	434T-64
2-17/32	2.5313	64.29	5/16	434T-0217
-	2.5591	65.00	5/16	434T-65
2-9/16	2.5625	65.09	5/16	434T-0218

A30: 112 - 143 A30: 90 - 92 A30: 4 - 6

HE, HI, HR, CR, SK, BR, CI, NC, WC

Coatings not listed above can be supplied as non-stocked standards. Process fees apply. →

TiN = 131T-XXXX	TiAlN = 131A-XXXX
TiCN = 131N-XXXX	AM200® = 131H-XXXX

Inserts sold in quantities of 1

Original T-A Drill Inserts

4 Series | HSS | Diameter Range: 1.850" - 2.570" (46.99mm - 65.28mm)

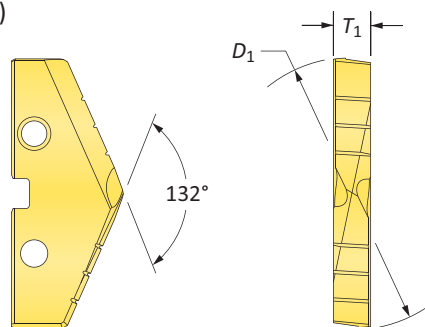

HSS Inserts – Super Cobalt

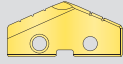
Fractional Equivalent	Insert			Part No.
	D_1 inch	D_1 mm	T_1	TiN 
-	1.8898	48.00	5/16	154T-48
1-29/32	1.9063	48.42	5/16	154T-0129
-	1.9291	49.00	5/16	154T-49
1-15/16	1.9375	49.21	5/16	154T-0130
-	1.9685	50.00	5/16	154T-50
1-31/32	1.9688	50.01	5/16	154T-0131
2	2.0000	50.80	5/16	154T-0200
-	2.0079	51.00	5/16	154T-51
2-1/32	2.0313	51.59	5/16	154T-0201
2-3/64	2.0472	52.00	5/16	154T-52
2-1/16	2.0625	52.39	5/16	154T-0202
-	2.0866	53.00	5/16	154T-53
2-3/32	2.0938	53.18	5/16	154T-0203
2-1/8	2.1250	53.98	5/16	154T-0204
-	2.1260	54.00	5/16	154T-54
2-5/32	2.1563	54.77	5/16	154T-0205
-	2.1654	55.00	5/16	154T-55
2-3/16	2.1875	55.56	5/16	154T-0206
-	2.2047	56.00	5/16	154T-56
2-7/32	2.2188	56.36	5/16	154T-0207
-	2.2441	57.00	5/16	154T-57
2-1/4	2.2500	57.15	5/16	154T-0208
2-9/32	2.2813	57.94	5/16	154T-0209
-	2.2835	58.00	5/16	154T-58
2-5/16	2.3125	58.74	5/16	154T-0210
-	2.3228	59.00	5/16	154T-59
2-11/32	2.3438	59.53	5/16	154T-0211
-	2.3622	60.00	5/16	154T-60
2-3/8	2.3750	60.33	5/16	154T-0212
-	2.4016	61.00	5/16	154T-61
2-13/32	2.4063	61.12	5/16	154T-0213
2-7/16	2.4375	61.91	5/16	154T-0214
-	2.4409	62.00	5/16	154T-62
2-15/32	2.4688	62.71	5/16	154T-0215
-	2.4803	63.00	5/16	154T-63
2-1/2	2.5000	63.50	5/16	154T-0216
-	2.5197	64.00	5/16	154T-64
2-17/32	2.5313	64.29	5/16	154T-0217
-	2.5591	65.00	5/16	154T-65
2-9/16	2.5625	65.09	5/16	154T-0218

Inserts sold in quantities of 1

A30: 112 - 143

A30: 90 - 92

A30: 4 - 6

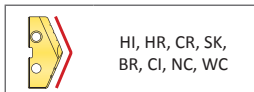
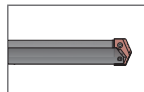
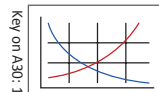

Coatings not listed above can be supplied as non-stocked standards. Process fees apply. →

TiN = 131T-XXXX

TiAlN = 131A-XXXX

TiCN = 131N-XXXX

AM200® = 131H-XXXX



Original T-A Drill Inserts

4 Series | HSS | Diameter Range: 1.850" - 2.570" (46.99mm - 65.28mm)

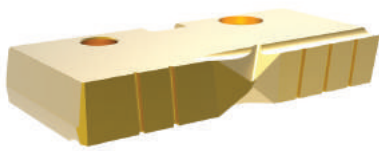

Flat Bottom

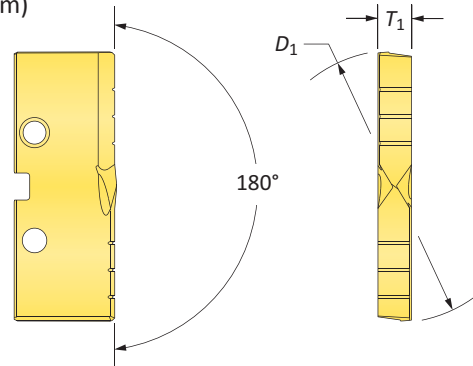

HSS Inserts – Super Cobalt

Fractional Equivalent	Insert			Part No.
	D ₁ inch	D ₁ mm	T ₁	
-	1.8898	48.00	5/16	154T-48-FB
1-29/32	1.9063	48.42	5/16	154T-0129-FB
-	1.9291	49.00	5/16	154T-49-FB
1-15/16	1.9375	49.21	5/16	154T-0130-FB
-	1.9685	50.00	5/16	154T-50-FB
1-31/32	1.9688	50.01	5/16	154T-0131-FB
2	2.0000	50.80	5/16	154T-0200-FB
-	2.0079	51.00	5/16	154T-51-FB
2-1/32	2.0313	51.59	5/16	154T-0201-FB
2-3/64	2.0472	52.00	5/16	154T-52-FB
2-1/16	2.0625	52.39	5/16	154T-0202-FB
-	2.0866	53.00	5/16	154T-53-FB
2-3/32	2.0938	53.18	5/16	154T-0203-FB
2-1/8	2.1250	53.98	5/16	154T-0204-FB
-	2.1260	54.00	5/16	154T-54-FB
2-5/32	2.1563	54.77	5/16	154T-0205-FB
-	2.1654	55.00	5/16	154T-55-FB
2-3/16	2.1875	55.56	5/16	154T-0206-FB
-	2.2047	56.00	5/16	154T-56-FB
2-7/32	2.2188	56.36	5/16	154T-0207-FB
-	2.2441	57.00	5/16	154T-57-FB
2-1/4	2.2500	57.15	5/16	154T-0208-FB
2-9/32	2.2813	57.94	5/16	154T-0209-FB
-	2.2835	58.00	5/16	154T-58-FB
2-5/16	2.3125	58.74	5/16	154T-0210-FB
-	2.3228	59.00	5/16	154T-59-FB
2-11/32	2.3438	59.53	5/16	154T-0211-FB
-	2.3622	60.00	5/16	154T-60-FB
2-3/8	2.3750	60.33	5/16	154T-0212-FB
-	2.4016	61.00	5/16	154T-61-FB
2-13/32	2.4063	61.12	5/16	154T-0213-FB
2-7/16	2.4375	61.91	5/16	154T-0214-FB
-	2.4409	62.00	5/16	154T-62-FB
2-15/32	2.4688	62.71	5/16	154T-0215-FB
-	2.4803	63.00	5/16	154T-63-FB
2-1/2	2.5000	63.50	5/16	154T-0216-FB
-	2.5197	64.00	5/16	154T-64-FB
2-17/32	2.5313	64.29	5/16	154T-0217-FB
-	2.5591	65.00	5/16	154T-65-FB
2-9/16	2.5625	65.09	5/16	154T-0218-FB

A30: 112 - 143

A30: 90 - 92

A30: 4 - 6

Key on A30-1

Coatings not listed above can be supplied as non-stocked standards. Process fees apply. →

TiN = 131T-XXXX	TiAlN = 131A-XXXX
TiCN = 131N-XXXX	AM200® = 131H-XXXX

Inserts sold in quantities of 1

T-A Drill Insert Holders

4 Series | Flange Shank

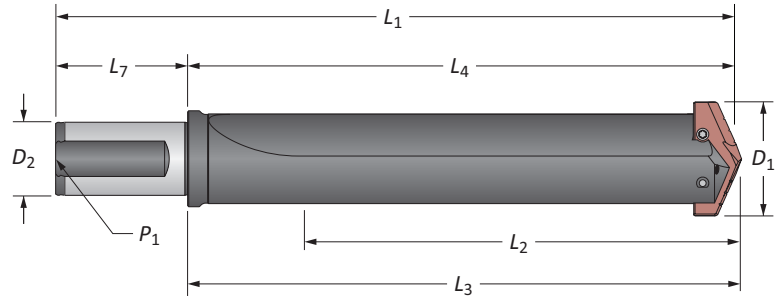

Straight Flute

	Length	D_1	Body				Shank			Part No.
			L_2	L_4	L_3	L_1	D_2	L_7	P_1	
i	Short	1-29/32 - 2-9/16	5-1/8	7-1/6	7-1/4	9-3/4	1-1/2	2-11/16	1/4	22040S-150F
	Standard	1-29/32 - 2-9/16	9-1/8	11-1/16	11-1/4	13-3/4	1-1/2	2-11/16	1/4	24040S-150F
m	Short	48.0 - 65.0	130.2	179.4	184.0	249.4	40.0	70.0	1/4*	22040S-40FM
	Extended	48.0 - 65.0	422.3	471.5	476.0	541.5	40.0	70.0	1/4*	25040S-40FM
	XL	48.0 - 65.0	625.0	674.7	679.0	744.7	40.0	70.0	1/4*	27040S-40FM
	3XL	48.0 - 65.0	879.0	928.7	933.0	998.7	40.0	70.0	1/4*	29040S-40FM

*Metric thread to BSP and ISO 7-1

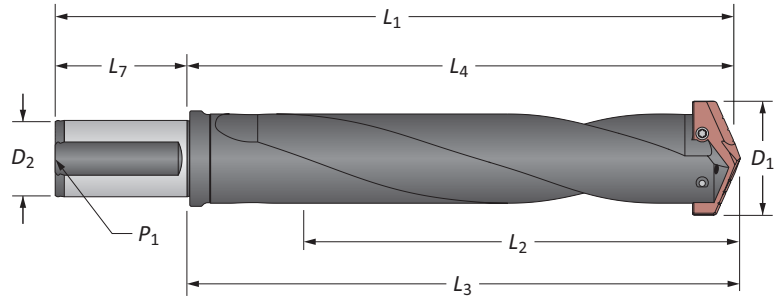

Helical Flute

	Length	D_1	Body				Shank			Part No.
			L_2	L_4	L_3	L_1	D_2	L_7	P_1	
i	Standard	1-29/32 - 2-9/16	9-1/8	11-1/16	11-1/4	13-3/4	1-1/2	2-11/16	1/4	24040H-150F
m	Standard	48.0 - 65.0	231.8	281.0	285.8	351.0	40.0	70.0	1/4*	24040H-40FM

*Metric thread to BSP and ISO 7-1

Connection Accessories

Insert Screws	Nylon Locking Screws	Insert Driver	Preset Torque Hand Driver	Replacement Tips	Admissible Tightening Torque*
7514-IP20-1	7514N-IP20-1	8IP-20	8IP-20TL	8IP-20B	121.3 in-lbs (1370 N-cm)

*Tightening torques are calculated with a friction coefficient of $\mu = 0.14$ and develop 90% of ultimate yield strength

A30: 86 - 89

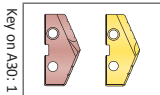

i = Imperial (in)

m = Metric (mm)

Screws sold in quantities of 10

WARNING Refer to Speed and Feed charts for recommended adjustments to speeds and feeds. Refer to page A30: 146 for deep hole drilling guidelines in this section of the catalog. Visit www.alliedmachine.com/DeepHoleGuidelines for the most up-to-date information and procedures. Factory technical assistance is available for your specific applications through our Application Engineering Team.

T-A Drill Insert Holders

4 Series | Taper Shank

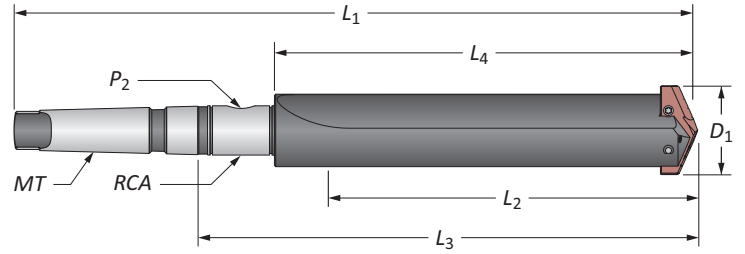

Straight Flute

	Length	D ₁	Body			Shank			Part No.	
			L ₂	L ₃	L ₄	L ₁	MT	P ₂		RCA
i	Short	1-29/32 - 2-9/16	5-1/8	6-1/2	8-5/8	13-1/16	#4	1/4	2T-4SR	22040S-004I
	Short	1-29/32 - 2-9/16	5-1/8	6-1/2	8-5/8	14-5/16	#5	1/4	2T-5SR	22040S-005I
	Standard	1-29/32 - 2-9/16	9-1/8	10-1/2	12-5/8	17-1/16	#4	1/4	2T-4SR	24040S-004I
	Standard	1-29/32 - 2-9/16	9-1/8	10-1/2	12-5/8	18-5/16	#5	1/4	2T-5SR	24040S-005I
	Extended	1-29/32 - 2-9/16	16-5/8	18	20-1/8	25-13/16	#5	1/4	2T-5SR	25040S-005I
	XL	1-29/32 - 2-9/16	24-5/8	26	28-1/8	33-13/16	#5	1/4	2T-5SR	27040S-005I
	3XL	1-29/32 - 2-9/16	34-5/8	36	38-1/8	43-13/16	#5	1/4	2T-5SR	29040S-005I
m	Short	48.0 - 65.0	130.1	165.1	219.1	363.5	#5**	1/4*	2T-5SRM	22040S-005M
	Extended	48.0 - 65.0	422.3	457.2	511.2	655.6	#5**	1/4*	2T-5SRM	25040S-005M
	XL	48.0 - 65.0	625.0	660.4	714.4	858.8	#5**	1/4*	2T-5SRM	27040S-005M
	3XL	48.0 - 65.0	879.0	914.4	968.4	1112.8	#5**	1/4*	2T-5SRM	29040S-005M

*Metric thread to BSP and ISO 7-1

**Per ISO 296 type BEK

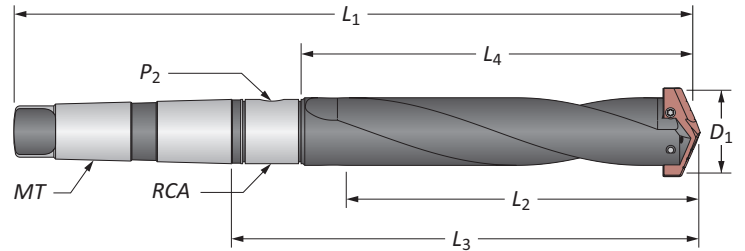

Helical Flute

	Length	D ₁	Body			Shank			Part No.	
			L ₂	L ₃	L ₄	L ₁	MT	P ₂		RCA
m	Standard	48.0 - 65.0	231.8	266.7	320.7	465.1	#5**	1/4*	2T-5SRM	24040H-005M

*Metric thread to BSP and ISO 7-1

**Per ISO 296 type BEK

Connection Accessories

Insert Screws	Nylon Locking Screws	Insert Driver	Preset Torque Hand Driver	Replacement Tips	Admissible Tightening Torque*
7514-IP20-1	7514N-IP20-1	8IP-20	8IP-20TL	8IP-20B	121.3 in-lbs (1370 N-cm)

*Tightening torques are calculated with a friction coefficient of $\mu = 0.14$ and develop 90% of ultimate yield strength

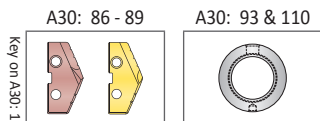

i = Imperial (in)

m = Metric (mm)

Screws sold in quantities of 10

WARNING Refer to Speed and Feed charts for recommended adjustments to speeds and feeds. Refer to page A30: 146 for deep hole drilling guidelines in this section of the catalog. Visit www.alliedmachine.com/DeepHoleGuidelines for the most up-to-date information and procedures. Factory technical assistance is available for your specific applications through our Application Engineering Team.

T-A Drill Insert Holders

4 Series | Straight Shank

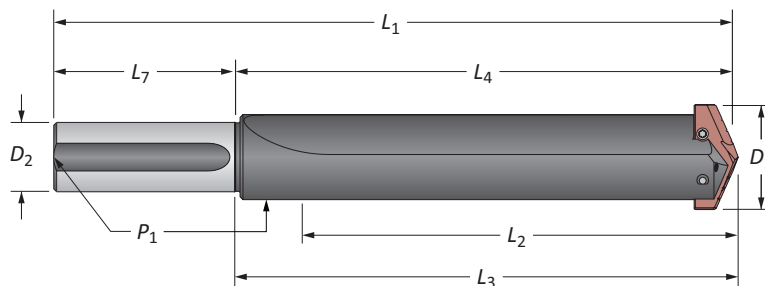

Straight Flute

Length	D_1	Body				Shank			Part No.
		L_2	L_4	L_3	L_1	D_2	L_7	P_1	
Short	1-29/32 - 2-9/16	5-1/8	6-1/2	6-11/16	10-1/2	1-1/2	4	1/4	22040S-150L
Short	1-29/32 - 2-9/16	5-1/8	6-1/2	6-11/16	10-1/2	1-3/4	4	1/4	22040S-175L
Standard	1-29/32 - 2-9/16	9-1/8	10-1/2	10-11/16	14-1/2	1-1/2	4	1/4	24040S-150L
Standard	1-29/32 - 2-9/16	9-1/8	10-1/2	10-11/16	14-1/2	1-3/4	4	1/4	24040S-175L
Extended	1-29/32 - 2-9/16	16-5/8	18	18-3/16	22	1-1/2	4	1/4	25040S-150L
XL	1-29/32 - 2-9/16	24-5/8	26	26-3/16	30	1-1/2	4	1/4	27040S-150L
3XL	1-29/32 - 2-9/16	34-5/8	36	36-3/16	40	1-1/2	4	1/4	29040S-150L

Connection Accessories

Insert Screws	Nylon Locking Screws	Insert Driver	Preset Torque Hand Driver	Replacement Tips	Admissible Tightening Torque*
7514-IP20-1	7514N-IP20-1	8IP-20	8IP-20TL	8IP-20B	121.3 in-lbs (1370 N-cm)

*Tightening torques are calculated with a friction coefficient of $\mu = 0.14$ and develop 90% of ultimate yield strength

A30: 86 - 89

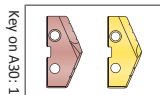

i = Imperial (in)

m = Metric (mm)

Screws sold in quantities of 10

WARNING Refer to Speed and Feed charts for recommended adjustments to speeds and feeds. Refer to page A30: 146 for deep hole drilling guidelines in this section of the catalog. Visit www.alliedmachine.com/DeepHoleGuidelines for the most up-to-date information and procedures. Factory technical assistance is available for your specific applications through our Application Engineering Team.



T-A Drill Accessories

4 Series | Rotary Coolant Adapters | Torx® Plus Screws

Rotary Coolant Adapter (RCA) and Accessories

	ID	OD	L ₁	Driving Rod Thread	P ₁	Part No.	RCA O-Rings	
							Kit Part No.**	Replacements
i	1-1/4	2-1/2	1-3/8	3/8-16	1/4	⚠ 2T-4SR	2T1-4SR	2T1-4OR-10
	1-3/4	3	1-3/8	3/8-16	1/4	⚠ 2T-5SR	2T1-5SR	2T1-5OR-10
m	31.75	63.50	34.92	M10 x 1.50	1/4*	⚠ 2T-4SRM	2T1-4SR	2T1-4OR-10
	44.45	76.20	34.92	M10 x 1.50	1/4*	⚠ 2T-5SRM	2T1-5SR	2T1-5OR-10

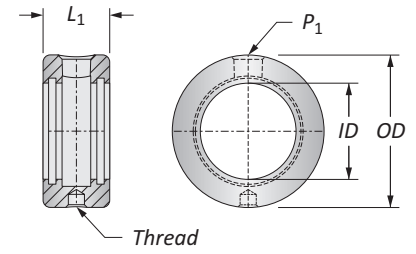

*Thread to BSP and ISO 7-1

**RCA Repair Kit includes (2) O-rings, (2) snap rings, and (2) thrust washers

⚠ Refer to page A30: 110 for proper RCA assembly and safety information

Connection Accessories

Insert Screws	Nylon Locking Screws	Insert Driver	Preset Torque Hand Driver	Replacement Tips	Admissible Tightening Torque*
7514-IP20-1	7514N-IP20-1	8IP-20	8IP-20TL	8IP-20B	121.3 in-lbs (1370 N-cm)

*Tightening torques are calculated with a friction coefficient of $\mu = 0.14$ and develop 90% of ultimate yield strength

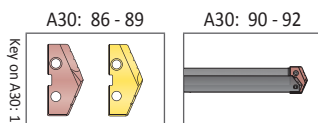

i = Imperial (in)
m = Metric (mm)
Inserts sold separately
Screws sold in packs of 10
O-rings sold in packs of 10

⚠ WARNING Refer to Speed and Feed charts for recommended adjustments to speeds and feeds. Refer to page A30: 146 for deep hole drilling guidelines in this section of the catalog. Visit www.alliedmachine.com/DeepHoleGuidelines for the most up-to-date information and procedures. Factory technical assistance is available for your specific applications through our Application Engineering Team.

GEN2 T-A Drill Inserts

5 Series | HSS | Diameter Range: 2.456" - 3.000" (62.38mm - 76.20mm)

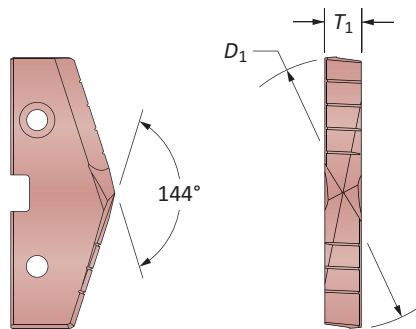

HSS Inserts – Super Cobalt | HSS

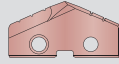
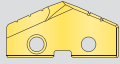
Fractional Equivalent	Insert			Super Cobalt Part No.	HSS Part No.
	D_1 inch	D_1 mm	T_1	 AM200®	 TiN
2-1/2	2.5000	63.50	7/16	455H-0216	435T-0216
–	2.5197	64.00	7/16	455H-64	435T-64
2-17/32	2.5313	64.29	7/16	455H-0217	435T-0217
2-9/16	2.5625	65.09	7/16	455H-0218	435T-0218
2-19/32	2.5938	65.88	7/16	455H-0219	435T-0219
–	2.5984	66.00	7/16	455H-66	435T-66
2-5/8	2.6250	66.68	7/16	455H-0220	435T-0220
2-21/32	2.6563	67.47	7/16	455H-0221	435T-0221
–	2.6772	68.00	7/16	455H-68	435T-68
2-11/16	2.6875	68.26	7/16	455H-0222	435T-0222
2-23/32	2.7188	69.05	7/16	455H-0223	435T-0223
2-3/4	2.7500	69.85	7/16	455H-0224	435T-0224
–	2.7559	70.00	7/16	455H-70	435T-70
2-25/32	2.7813	70.64	7/16	455H-0225	435T-0225
2-13/16	2.8125	71.44	7/16	455H-0226	435T-0226
–	2.8346	72.00	7/16	455H-72	435T-72
2-27/32	2.8438	72.23	7/16	455H-0227	435T-0227
2-7/8	2.8750	73.03	7/16	455H-0228	435T-0228
2-29/32	2.9063	73.82	7/16	455H-0229	435T-0229
–	2.9134	74.00	7/16	455H-74	435T-74
2-15/16	2.9375	74.41	7/16	455H-0230	435T-0230
2-31/32	2.9688	75.61	7/16	455H-0231	435T-0231
–	2.9921	76.00	7/16	455H-76	435T-76
3	3.0000	76.20	7/16	455H-0300	435T-0300

F

THREADING

X

SPECIALS

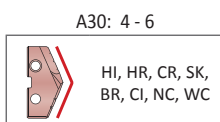
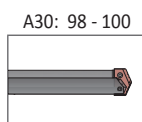
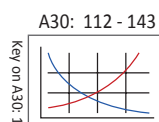

Coatings not listed above
can be supplied as
non-stocked standards.
Process fees apply. →

TiN = 131T-XXXX	TiAlN = 131A-XXXX
TiCN = 131N-XXXX	AM200® = 131H-XXXX

Inserts sold in quantities of 1



Original T-A Drill Inserts

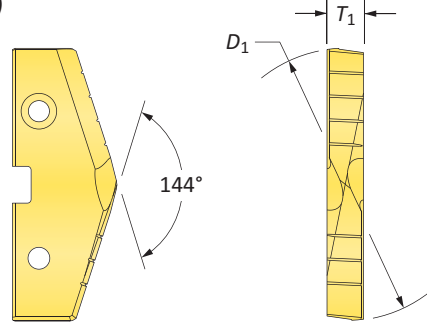

5 Series | HSS | Diameter Range: 2.456" - 3.000" (62.38mm - 76.20mm)

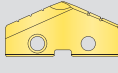
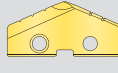

HSS Inserts – Super Cobalt | HSS

Fractional Equivalent	Insert			Super Cobalt Part No.*	HSS Part No.
	D ₁ inch	D ₁ mm	T ₁	 TiN	 TiN
2-1/2	2.5000	63.50	7/16	155T-0216	135T-0216
-	2.5197	64.00	7/16	155T-64	135T-64
2-17/32	2.5313	64.29	7/16	155T-0217	135T-0217
2-9/16	2.5625	65.09	7/16	155T-0218	135T-0218
2-19/32	2.5938	65.88	7/16	155T-0219	135T-0219
-	2.5984	66.00	7/16	155T-66	135T-66
2-5/8	2.6250	66.68	7/16	155T-0220	135T-0220
2-21/32	2.6563	67.47	7/16	155T-0221	135T-0221
-	2.6772	68.00	7/16	155T-68	135T-68
2-11/16	2.6875	68.26	7/16	155T-0222	135T-0222
2-23/32	2.7188	69.05	7/16	155T-0223	135T-0223
2-3/4	2.7500	69.85	7/16	155T-0224	135T-0224
-	2.7559	70.00	7/16	155T-70	135T-70
2-25/32	2.7813	70.64	7/16	155T-0225	135T-0225
2-13/16	2.8125	71.44	7/16	155T-0226	135T-0226
-	2.8346	72.00	7/16	155T-72	135T-72
2-27/32	2.8438	72.23	7/16	155T-0227	135T-0227
2-7/8	2.8750	73.03	7/16	155T-0228	135T-0228
2-29/32	2.9063	73.82	7/16	155T-0229	135T-0229
-	2.9134	74.00	7/16	155T-74	135T-74
2-15/16	2.9375	74.41	7/16	155T-0230	135T-0230
2-31/32	2.9688	75.61	7/16	155T-0231	135T-0231
-	2.9921	76.00	7/16	155T-76	135T-76
3	3.0000	76.20	7/16	155T-0300	135T-0300

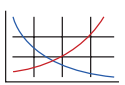
*Available as non-stocked standard

A30: 112 - 143  A30: 98 - 100  A30: 4 - 6  HI, HR, CR, SK, BR, CI, NC, WC

Coatings not listed above can be supplied as non-stocked standards. Process fees apply. →

TiN = 131T-XXXX	TiAlN = 131A-XXXX
TiCN = 131N-XXXX	AM200® = 131H-XXXX

Inserts sold in quantities of 1

A DRILLING
B BORING
C REAMING
D BURNISHING
E THREADING
X SPECIALS



GEN2 T-A Drill Inserts

6 Series | HSS | Diameter Range: 3.001" - 3.507" (76.22mm - 89.08mm)

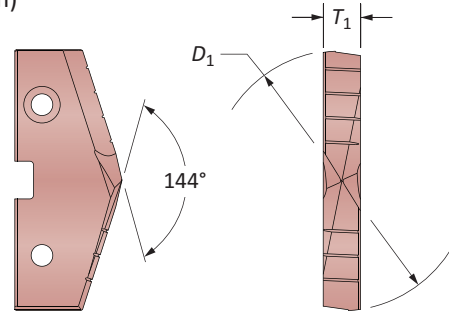
(for use with 5 series holders)

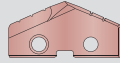

HSS Inserts – Super Cobalt | HSS

Fractional Equivalent	Insert			Super Cobalt Part No.	HSS Part No.
	D ₁ inch	D ₁ mm	T ₁	 AM200®	 TiN
3-1/32	3.0313	76.99	7/16	456H-0301	436T-0301
3-1/16	3.0625	77.79	7/16	456H-0302	436T-0302
-	3.0709	78.00	7/16	456H-78	436T-78
3-3/32	3.0938	78.58	7/16	456H-0303	436T-0303
3-1/8	3.1250	79.38	7/16	456H-0304	436T-0304
-	3.1496	80.00	7/16	456H-80	436T-80
3-5/32	3.1563	80.17	7/16	456H-0305	436T-0305
3-3/16	3.1875	80.96	7/16	456H-0306	436T-0306
3-7/32	3.2188	81.76	7/16	456H-0307	436T-0307
-	3.2283	82.00	7/16	456H-82	436T-82
3-1/4	3.2500	82.55	7/16	456H-0308	436T-0308
3-9/32	3.2813	83.34	7/16	456H-0309	436T-0309
-	3.3071	84.00	7/16	456H-84	436T-84
3-5/16	3.3125	84.14	7/16	456H-0310	436T-0310
3-11/32	3.3438	84.93	7/16	456H-0311	436T-0311
3-3/8	3.3750	85.73	7/16	456H-0312	436T-0312
-	3.3858	86.00	7/16	456H-86	436T-86
3-13/32	3.4063	86.52	7/16	456H-0313	436T-0313
3-7/16	3.4375	87.31	7/16	456H-0314	436T-0314
-	3.4646	88.00	7/16	456H-88	436T-88
3-15/32	3.4688	88.11	7/16	456H-0315	436T-0315
3-1/2	3.5000	88.90	7/16	456H-0316	436T-0316

A DRILLING

B BORING

C REAMING

D BURNISHING

F THREADING

X SPECIALS

A30: 112 - 143

A30: 98 - 100

A30: 4 - 6

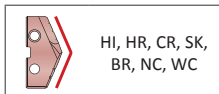
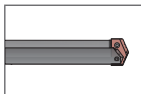
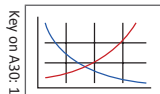

Coatings not listed above can be supplied as non-stocked standards. Process fees apply. →

TiN = 131T-XXXX	TiAlN = 131A-XXXX
TiCN = 131N-XXXX	AM200® = 131H-XXXX

Inserts sold in quantities of 1



Original T-A Drill Inserts

6 Series | HSS | Diameter Range: 3.001" - 3.507" (76.22mm - 89.08mm)

(for use with 5 series holders)

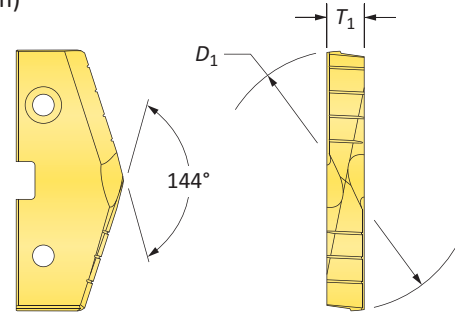
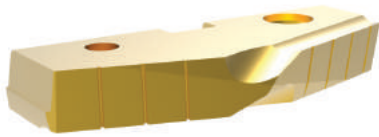

HSS Inserts – Super Cobalt | HSS

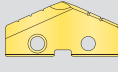
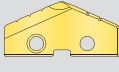
Fractional Equivalent	Insert			Super Cobalt Part No.*	HSS Part No.
	D_1 inch	D_1 mm	T_1	 TiN	 TiN
3-1/32	3.0313	76.99	7/16	156T-0301	136T-0301
3-1/16	3.0625	77.79	7/16	156T-0302	136T-0302
-	3.0709	78.00	7/16	156T-78	136T-78
3-3/32	3.0938	78.58	7/16	156T-0303	136T-0303
3-1/8	3.1250	79.38	7/16	156T-0304	136T-0304
-	3.1496	80.00	7/16	156T-80	136T-80
3-5/32	3.1563	80.17	7/16	156T-0305	136T-0305
3-3/16	3.1875	80.96	7/16	156T-0306	136T-0306
3-7/32	3.2188	81.76	7/16	156T-0307	136T-0307
-	3.2283	82.00	7/16	156T-82	136T-82
3-1/4	3.2500	82.55	7/16	156T-0308	136T-0308
3-9/32	3.2813	83.34	7/16	156T-0309	136T-0309
-	3.3071	84.00	7/16	156T-84	136T-84
3-5/16	3.3125	84.14	7/16	156T-0310	136T-0310
3-11/32	3.3438	84.93	7/16	156T-0311	136T-0311
3-3/8	3.3750	85.73	7/16	156T-0312	136T-0312
-	3.3858	86.00	7/16	156T-86	136T-86
3-13/32	3.4063	86.52	7/16	156T-0313	136T-0313
3-7/16	3.4375	87.31	7/16	156T-0314	136T-0314
-	3.4646	88.00	7/16	156T-88	136T-88
3-15/32	3.4688	88.11	7/16	156T-0315	136T-0315
3-1/2	3.5000	88.90	7/16	156T-0316	136T-0316

*Available as non-stocked standard

Key on A30-1

A30: 112 - 143

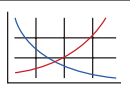

A30: 98 - 100



A30: 4 - 6



HI, HR, CR, SK,
BR, NC, WC

Coatings not listed above can be supplied as non-stocked standards. Process fees apply. →

TiN = 131T-XXXX	TiAlN = 131A-XXXX
TiCN = 131N-XXXX	AM200® = 131H-XXXX

Inserts sold in quantities of 1

T-A Drill Insert Holders

5 Series | Flange Shank

A DRILLING

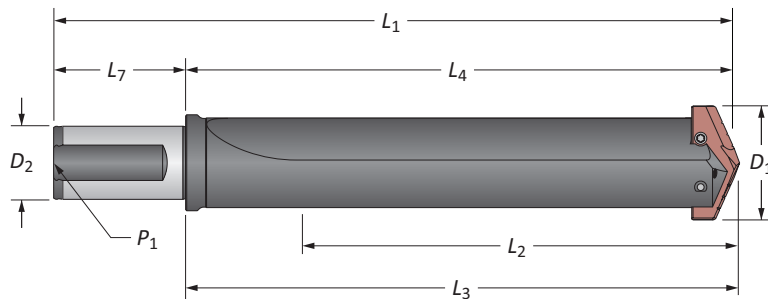

Straight Flute

	Length	D ₁	Body				Shank			Part No.
			L ₂	L ₄	L ₃	L ₁	D ₂	L ₇	P ₁	
i	Short	2-1/2 - 3-1/2	6-49/64	8-1/2	8-3/4	13-1/4	2	4-1/2	1/2	22050S-200F
	Extended	2-1/2 - 3-1/2	18-17/64	20	20-1/4	24-3/4	2	4-1/2	1/2	25050S-200F
m	Short	64.00 - 88.00	172	215.9	222.3	302.3	50.0	80.0	1/2*	22050S-50FM
	Extended	64.00 - 88.00	464	508	514.4	594.4	50.0	80.0	1/2*	25050S-50FM

*Metric thread to BSP and ISO 7-1

B BORING

C REAMING

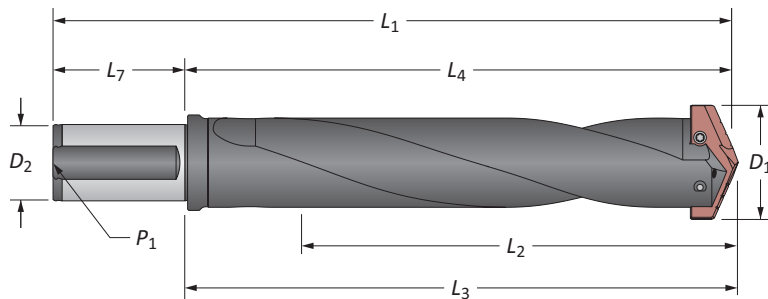

Helical Flute

	Length	D ₁	Body				Shank			Part No.
			L ₂	L ₄	L ₃	L ₁	D ₂	L ₇	P ₁	
i	Standard	2-1/2 - 3-1/2	10-3/4	12-1/2	12-3/4	17-1/4	2	4-1/2	1/2	24050H-200F
m	Standard	64.0 - 88.0	273	317.5	323.9	403.9	50.0	80.0	1/2*	24050H-50FM

*Metric thread to BSP and ISO 7-1

D BURNISHING

F THREADING

Connection Accessories

Insert Screws	Nylon Locking Screws	Insert Driver	Preset Torque Hand Driver	Replacement Tips	Admissible Tightening Torque*
7619-IP25-1	-	8IP-25	-	-	155.0 in-lbs (1750 N-cm)

*Tightening torques are calculated with a friction coefficient of $\mu = 0.14$ and develop 90% of ultimate yield strength

X SPECIALS

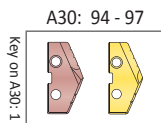

i = Imperial (in)
m = Metric (mm)

Screws sold in quantities of 10

WARNING Refer to Speed and Feed charts for recommended adjustments to speeds and feeds. Refer to page A30: 146 for deep hole drilling guidelines in this section of the catalog. Visit www.alliedmachine.com/DeepHoleGuidelines for the most up-to-date information and procedures. Factory technical assistance is available for your specific applications through our Application Engineering Team.



T-A Drill Insert Holders

5 Series | Taper Shank

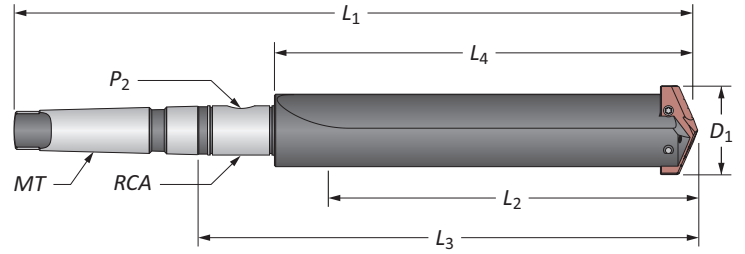

Straight Flute

	Length	D ₁	Body			Shank				Part No.
			L ₂	L ₃	L ₄	L ₁	MT	P ₂	RCA	
i	Short	2-1/2 - 3-1/2	6-3/4	8-1/2	11-5/16	16-15/16	#5	1/2	2T-6SR	22050S-005I
	Standard	2-1/2 - 3-1/2	10-3/4	12-1/2	15-5/16	20-15/16	#5	1/2	2T-6SR	24050S-005I
	Extended	2-1/2 - 3-1/2	18-1/4	20	22-13/16	28-7/16	#5	1/2	2T-6SR	▲ 25050S-005I
	XL	2-1/2 - 3-1/2	26	27-3/4	30-9/16	36-3/16	#5	1/2	2T-6SR	▲ 27050S-005I
	3XL	2-1/2 - 3-1/2	35	36-3/4	39-9/16	45-3/16	#5	1/2	2T-6SR	▲ 29050S-005I
m	Short	64.0 - 88.0	171.5	215.9	287.3	430.2	#5**	1/2*	2T-6SRM	22050S-005M
	Extended	64.0 - 88.0	463.6	508.0	579.4	722.3	#5**	1/2*	2T-6SRM	▲ 25050S-005M
	XL	64.0 - 88.0	660.0	704.8	776.2	919.1	#5**	1/2*	2T-6SRM	▲ 27050S-005M
	3XL	64.0 - 88.0	889.0	933.4	1004.8	1147.7	#5**	1/2*	2T-6SRM	▲ 29050S-005M

*Metric thread to BSP and ISO 7-1

**Per ISO 296 type BEK

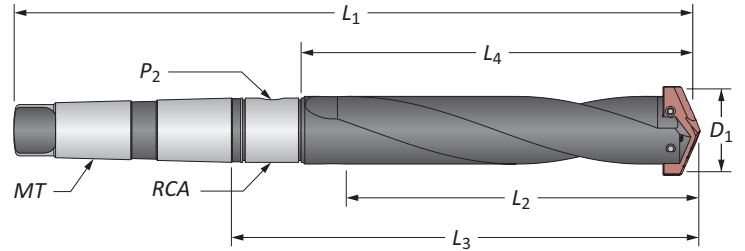

Helical Flute

	Length	D ₁	Body			Shank				Part No.
			L ₂	L ₄	L ₃	L ₁	MT	P ₂	RCA	
m	Standard	64.0 - 88.0	273.1	317.5	388.9	531.8	#5**	1/2*	2T-6SRM	24050H-005M

*Metric thread to BSP and ISO 7-1

**Per ISO 296 type BEK

Connection Accessories

Insert Screws	Nylon Locking Screws	Insert Driver	Preset Torque Hand Driver	Replacement Tips	Admissible Tightening Torque*
7619-IP25-1	-	8IP-25	-	-	155.0 in-lbs (1750 N-cm)

*Tightening torques are calculated with a friction coefficient of $\mu = 0.14$ and develop 90% of ultimate yield strength

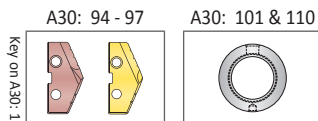

i = Imperial (in)

m = Metric (mm)

Screws sold in quantities of 10

WARNING Refer to Speed and Feed charts for recommended adjustments to speeds and feeds. Refer to page A30: 146 for deep hole drilling guidelines in this section of the catalog. Visit www.alliedmachine.com/DeepHoleGuidelines for the most up-to-date information and procedures. Factory technical assistance is available for your specific applications through our Application Engineering Team.

A DRILLING
B BORING
C REAMING
D BURNISHING
E THREADING
X SPECIALS

T-A Drill Insert Holders

5 Series | Straight Shank

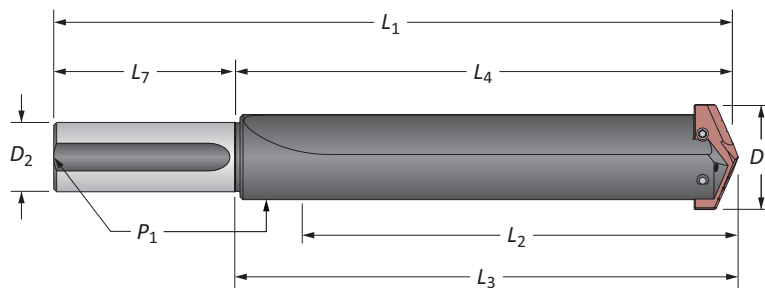
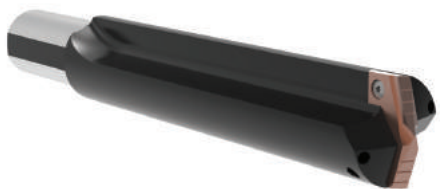

Straight Flute

Length	D ₁	Body				Shank			Part No.
		L ₂	L ₄	L ₃	L ₁	D ₂	L ₇	P ₁	
Short	2-1/2 - 3-1/2	6-3/4	8-1/2	8-3/4	12-1/2	2	4	1/2	22050S-200L
Standard	2-1/2 - 3-1/2	10-3/4	12-1/2	12-3/4	16-1/2	2	4	1/2	24050S-200L
i Extended	2-1/2 - 3-1/2	18-1/4	20	20-1/4	24	2	4	1/2	i 25050S-200L
XL	2-1/2 - 3-1/2	26	27-3/4	28	31-3/4	2	4	1/2	i 27050S-200L
3XL	2-1/2 - 3-1/2	35	36-3/4	37	40-3/4	2	4	1/2	i 29050S-200L

Connection Accessories

Insert Screws	Nylon Locking Screws	Insert Driver	Preset Torque Hand Driver	Replacement Tips	Admissible Tightening Torque*
7619-IP25-1	-	8IP-25	-	-	155.0 in-lbs (1750 N-cm)

*Tightening torques are calculated with a friction coefficient of $\mu = 0.14$ and develop 90% of ultimate yield strength

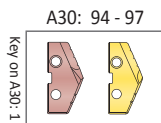

i = Imperial (in)
m = Metric (mm)

Screws sold in quantities of 10

WARNING Refer to Speed and Feed charts for recommended adjustments to speeds and feeds. Refer to page A30: 146 for deep hole drilling guidelines in this section of the catalog. Visit www.alliedmachine.com/DeepHoleGuidelines for the most up-to-date information and procedures. Factory technical assistance is available for your specific applications through our Application Engineering Team.



T-A Drill Accessories

5/6 Series | Rotary Coolant Adapters | Torx® Plus Screws

Rotary Coolant Adapter (RCA) and Accessories

	ID	OD	L ₁	Driving Rod Thread	P ₁	Part No.	RCA O-Rings	
							Kit Part No.**	Replacements
i	2-1/4	3-3/4	1-3/4	1/2-13	1/2	⚠ 2T-6SR	2T1-6SR	2T1-6OR-10
m	57.15	95.27	44.45	M12 x 1.75	1/2*	⚠ 2T-6SRM	2T1-6SR	2T1-6OR-10

*Thread to BSP and ISO 7-1

**RCA Repair Kit includes (2) O-rings, (2) snap rings, and (2) thrust washers

⚠ Refer to page A30: 110 for proper RCA assembly and safety information

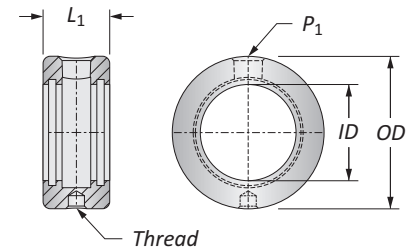

Connection Accessories

					Admissible Tightening Torque*
Insert Screws	Nylon Locking Screws	Insert Driver	Preset Torque Hand Driver	Replacement Tips	
7619-IP25-1	-	8IP-25	-	-	155.0 in-lbs (1750 N-cm)

*Tightening torques are calculated with a friction coefficient of $\mu = 0.14$ and develop 90% of ultimate yield strength

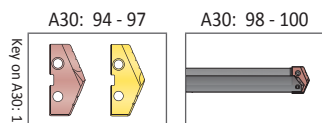

i = Imperial (in)
m = Metric (mm)
 Inserts sold separately
 Screws sold in packs of 10
 O-rings sold in packs of 10



⚠ WARNING Refer to Speed and Feed charts for recommended adjustments to speeds and feeds. Refer to page A30: 146 for deep hole drilling guidelines in this section of the catalog. Visit www.alliedmachine.com/DeepHoleGuidelines for the most up-to-date information and procedures. Factory technical assistance is available for your specific applications through our Application Engineering Team.

GEN2 T-A Drill Inserts

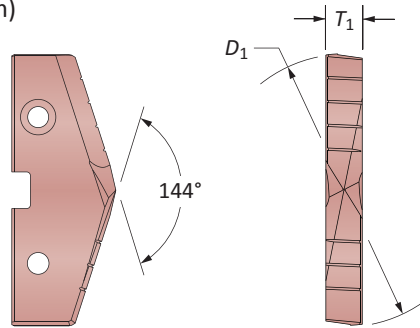
7 Series | HSS | Diameter Range: 3.508" - 4.000" (89.10mm - 101.60mm)

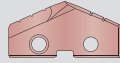

HSS Inserts – Super Cobalt | HSS

Fractional Equivalent	Insert			Super Cobalt Part No.	HSS Part No.
	D_1 inch	D_1 mm	T_1	 AM200®	 TiN
3-17/32	3.5313	89.69	7/16	457H-0317	437T-0317
–	3.5433	90.00	7/16	457H-90	437T-90
3-9/16	3.5625	90.49	7/16	457H-0318	437T-0318
3-19/32	3.5938	91.28	7/16	457H-0319	437T-0319
–	3.6221	92.00	7/16	457H-92	437T-92
3-5/8	3.6250	92.08	7/16	457H-0320	437T-0320
3-21/32	3.6563	92.87	7/16	457H-0321	437T-0321
3-11/16	3.6875	93.66	7/16	457H-0322	437T-0322
–	3.7008	94.00	7/16	457H-94	437T-94
3-23/32	3.7188	94.46	7/16	457H-0323	437T-0323
3-3/4	3.7500	95.25	7/16	457H-0324	437T-0324
–	3.7795	96.00	7/16	457H-96	437T-96
3-25/32	3.7813	96.04	7/16	457H-0325	437T-0325
3-13/16	3.8125	96.84	7/16	457H-0326	437T-0326
3-27/32	3.8438	97.63	7/16	457H-0327	437T-0327
–	3.8583	98.00	7/16	457H-98	437T-98
3-7/8	3.8750	98.43	7/16	457H-0328	437T-0328
3-29/32	3.9063	99.22	7/16	457H-0329	437T-0329
–	3.9370	100.00	7/16	457H-100	437T-100
3-15/16	3.9375	100.01	7/16	457H-0330	437T-0330
3-31/32	3.9688	100.81	7/16	457H-0331	437T-0331
4	4.0000	101.60	7/16	457H-0400	437T-0400

D BURNISHING

F THREADING

X SPECIALS

A30: 112 - 143

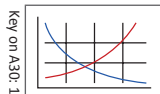

A30: 106 - 108

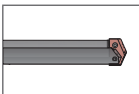

A30: 4 - 6

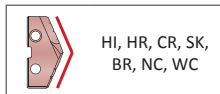

Coatings not listed above
can be supplied as
non-stocked standards.
Process fees apply. →

TiN = 131T-XXXX	TiAlN = 131A-XXXX
TiCN = 131N-XXXX	AM200® = 131H-XXXX

Inserts sold in quantities of 1



Original T-A Drill Inserts

7 Series | HSS | Diameter Range: 3.508" - 4.000" (89.10mm - 101.60mm)

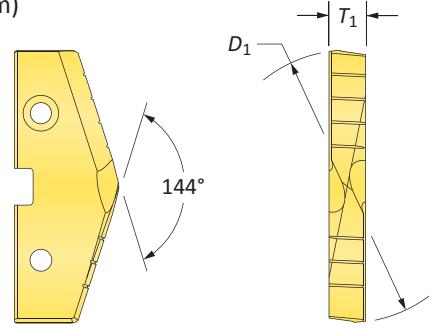
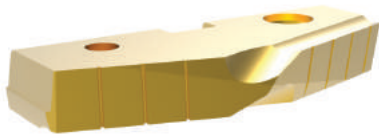

HSS Inserts – Super Cobalt | HSS

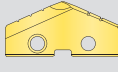
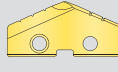
Fractional Equivalent	Insert			Super Cobalt Part No.*		HSS Part No.	
	D_1 inch	D_1 mm	T_1	 TiN	 TiN		
3-17/32	3.5313	89.69	7/16	157T-0317	137T-0317		
-	3.5433	90.00	7/16	157T-90	137T-90		
3-9/16	3.5625	90.49	7/16	157T-0318	137T-0318		
3-19/32	3.5938	91.28	7/16	157T-0319	137T-0319		
-	3.6221	92.00	7/16	157T-92	137T-92		
3-5/8	3.6250	92.08	7/16	157T-0320	137T-0320		
3-21/32	3.6563	92.87	7/16	157T-0321	137T-0321		
3-11/16	3.6875	93.66	7/16	157T-0322	137T-0322		
-	3.7008	94.00	7/16	157T-94	137T-94		
3-23/32	3.7188	94.46	7/16	157T-0323	137T-0323		
3-3/4	3.7500	95.25	7/16	157T-0324	137T-0324		
-	3.7795	96.00	7/16	157T-96	137T-96		
3-25/32	3.7813	96.04	7/16	157T-0325	137T-0325		
3-13/16	3.8125	96.84	7/16	157T-0326	137T-0326		
3-27/32	3.8438	97.63	7/16	157T-0327	137T-0327		
-	3.8583	98.00	7/16	157T-98	137T-98		
3-7/8	3.8750	98.43	7/16	157T-0328	137T-0328		
3-29/32	3.9063	99.22	7/16	157T-0329	137T-0329		
-	3.9370	100.00	7/16	157T-100	137T-100		
3-15/16	3.9375	100.01	7/16	157T-0330	137T-0330		
3-31/32	3.9688	100.81	7/16	157T-0331	137T-0331		
4	4.0000	101.60	7/16	157T-0400	137T-0400		

*Available as non-stocked standard

Key on A30-1

A30: 112 - 143

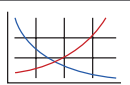

A30: 106 - 108



A30: 4 - 6



HI, HR, CR, SK,
BR, NC, WC

Coatings not listed above can be supplied as non-stocked standards. Process fees apply. →

TiN = 131T-XXXX	TiAlN = 131A-XXXX
TiCN = 131N-XXXX	AM200® = 131H-XXXX

Inserts sold in quantities of 1



GEN2 T-A Drill Inserts

8 Series | HSS | Diameter Range: 4.001" - 4.507" (101.63mm - 114.48mm)

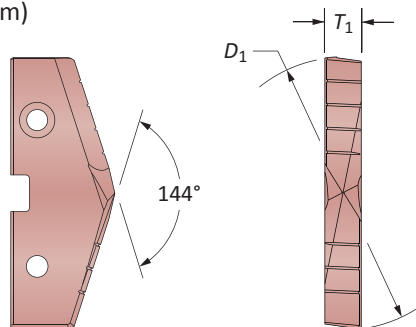
(for use with 7 series holders)

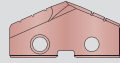

HSS Inserts – Super Cobalt | HSS

Fractional Equivalent	Insert			Super Cobalt Part No.	HSS Part No.
	D_1 inch	D_1 mm	T_1	 AM200®	 TiN
4-1/64	4.0157	102.00	7/16	458H-102	438T-102
4-1/16	4.0625	103.19	7/16	458H-0402	438T-0402
4-3/32	4.0945	104.00	7/16	458H-104	438T-104
4-1/8	4.1250	104.75	7/16	458H-0404	438T-0404
–	4.1732	106.00	7/16	458H-106	438T-106
4-3/16	4.1875	106.36	7/16	458H-0406	438T-0406
4-1/4	4.2500	107.95	7/16	458H-0408	438T-0408
–	4.2520	108.00	7/16	458H-108	438T-108
4-5/16	4.3125	109.54	7/16	458H-0410	438T-0410
–	4.3307	110.00	7/16	458H-110	438T-110
4-3/8	4.3750	111.13	7/16	458H-0412	438T-0412
–	4.4094	112.00	7/16	458H-112	438T-112
4-7/16	4.4375	112.71	7/16	458H-0414	438T-0414
–	4.4882	114.00	7/16	458H-114	438T-114
4-1/2	4.5000	114.30	7/16	458H-0416	438T-0416

D

BURNISHING

F

THREADING

X

SPECIALS

A30: 112 - 143

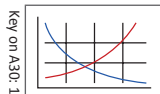

A30: 106 - 108

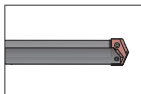

A30: 4 - 6

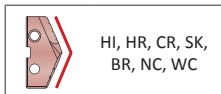

HI, HR, CR, SK,
BR, NC, WC

Coatings not listed above
can be supplied as
non-stocked standards.
Process fees apply. →

TiN = 131T-XXXX	TiAlN = 131A-XXXX
TiCN = 131N-XXXX	AM200® = 131H-XXXX

Inserts sold in quantities of 1





Original T-A Drill Inserts

8 Series | HSS | Diameter Range: 4.001" - 4.507" (101.63mm - 114.48mm)

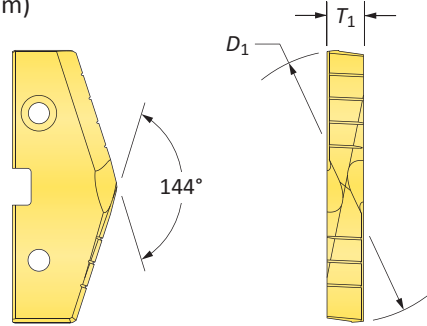
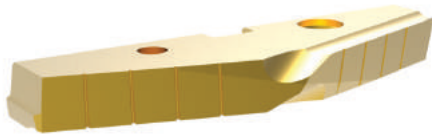
(for use with 7 series holders)

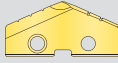

HSS Inserts – Super Cobalt | HSS

Fractional Equivalent	Insert			Super Cobalt Part No.*	HSS Part No.
	D_1 inch	D_1 mm	T_1	 TiN	 TiN
4-1/64	4.0157	102.00	7/16	158T-102	138T-102
4-1/16	4.0625	103.19	7/16	158T-0402	138T-0402
4-3/32	4.0945	104.00	7/16	158T-104	138T-104
4-1/8	4.1250	104.75	7/16	158T-0404	138T-0404
-	4.1732	106.00	7/16	158T-106	138T-106
4-3/16	4.1875	106.36	7/16	158T-0406	138T-0406
4-1/4	4.2500	107.95	7/16	158T-0408	138T-0408
-	4.2520	108.00	7/16	158T-108	138T-108
4-5/16	4.3125	109.54	7/16	158T-0410	138T-0410
-	4.3307	110.00	7/16	158T-110	138T-110
4-3/8	4.3750	111.13	7/16	158T-0412	138T-0412
-	4.4094	112.00	7/16	158T-112	138T-112
4-7/16	4.4375	112.71	7/16	158T-0414	138T-0414
-	4.4882	114.00	7/16	158T-114	138T-114
4-1/2	4.5000	114.30	7/16	158T-0416	138T-0416

*Available as non-stocked standard

A30: 112 - 143

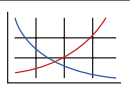

A30: 106 - 108



A30: 4 - 6



HI, HR, CR, SK,
BR, NC, WC

Coatings not listed above can be supplied as non-stocked standards. Process fees apply. →

TiN = 131T-XXXX	TiAlN = 131A-XXXX
TiCN = 131N-XXXX	AM200® = 131H-XXXX

Inserts sold in quantities of 1

T-A Drill Insert Holders

7 Series | Flange Shank

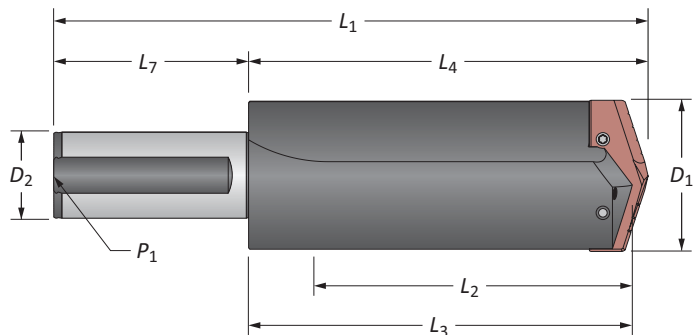

Straight Flute

	Length	D_1	Body				Shank			Part No.
			L_2	L_4	L_3	L_1	D_2	L_7	P_1	
i	Short	3-17/32 - 4-1/2	6-49/64	8-7/8	9-1/8	13-5/8	2	4-1/2	1/2	22070S-200F
	Extended	3-17/32 - 4-1/2	21-57/64	23-57/64	24-1/4	27-3/4	2	4-1/2	1/2	25070S-200F
m	Short	90.0 - 114.0	172	225.4	231.8	311.8	50.0	80.0	1/2*	22070S-50FM
	Extended	90.0 - 114.0	556	606.9	616	696	50.0	80.0	1/2*	25070S-50FM

*Metric thread to BSP and ISO 7-1

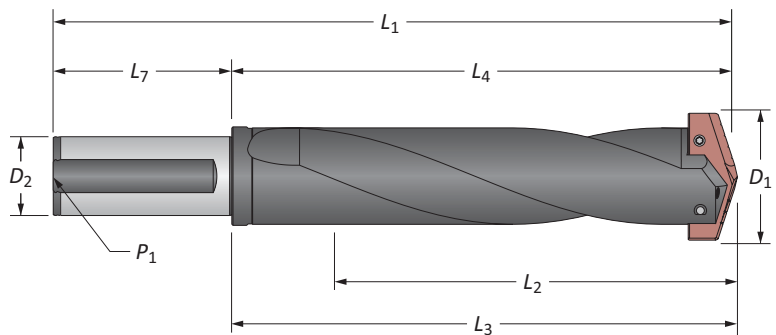

Helical Flute

	Length	D_1	Body				Shank			Part No.
			L_2	L_4	L_3	L_1	D_2	L_7	P_1	
i	Standard	3-17/32 - 4-1/2	10-3/4	12-7/8	13-1/8	17-5/8	2	4-1/2	1/2	24070H-200F
m	Standard	90.0 - 114.0	273	327	333.4	413.4	50.0	80.0	1/2*	24070H-50FM

*Metric thread to BSP and ISO 7-1

Connection Accessories

Insert Screws	Nylon Locking Screws	Insert Driver	Preset Torque Hand Driver	Replacement Tips	Admissible Tightening Torque*
7619-IP25-1	-	8IP-25	-	-	155.0 in-lbs (1750 N-cm)

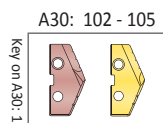
*Tightening torques are calculated with a friction coefficient of $\mu = 0.14$ and develop 90% of ultimate yield strength

i = Imperial (in)

m = Metric (mm)

Screws sold in quantities of 10

WARNING Refer to Speed and Feed charts for recommended adjustments to speeds and feeds. Refer to page A30: 146 for deep hole drilling guidelines in this section of the catalog. Visit www.alliedmachine.com/DeepHoleGuidelines for the most up-to-date information and procedures. Factory technical assistance is available for your specific applications through our Application Engineering Team.



T-A Drill Insert Holders

7 Series | Taper Shank

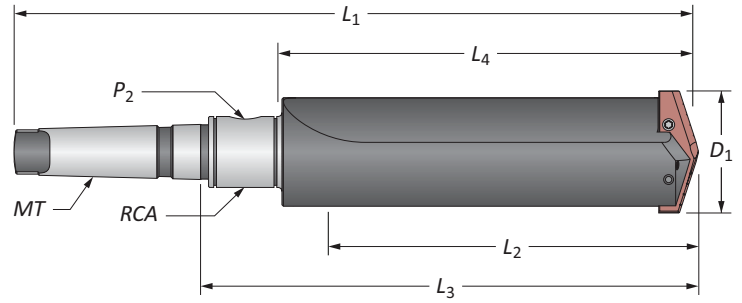

Straight Flute

	Length	D ₁	Body				Shank			Part No.
			L ₂	L ₃	L ₄	L ₁	MT	P ₂	RCA	
i	Short	3-17/32 - 4-1/2	6-3/4	8-7/8	11-11/16	17-5/16	#5	1/2	2T-6SR	22070S-005I
	Standard	3-17/32 - 4-1/2	10-3/4	12-7/8	15-11/16	21-5/16	#5	1/2	2T-6SR	24070S-005I
	Extended	3-17/32 - 4-1/2	21-7/8	24	26-13/16	32-7/16	#5	1/2	2T-6SR	▲ 25070S-005I
	XL	3-17/32 - 4-1/2	27	29-1/8	31-15/16	37-9/16	#5	1/2	2T-6SR	▲ 27070S-005I
	3XL	3-17/32 - 4-1/2	37	39-1/8	41-5/16	47-9/16	#5	1/2	2T-6SR	▲ 29070S-005I
m	Short	90.0 - 114.0	171.5	225.4	296.8	439.7	#5**	1/2*	2T-6SRM	22070S-005M
	Extended	90.0 - 114.0	555.6	609.6	681.1	823.9	#5**	1/2*	2T-6SRM	▲ 25070S-005M
	XL	90.0 - 114.0	685.0	739.7	811.2	954.0	#5**	1/2*	2T-6SRM	▲ 27070S-005M
	3XL	90.0 - 114.0	939.0	993.7	1065.2	1208.0	#5**	1/2*	2T-6SRM	▲ 29070S-005M

*Metric thread to BSP and ISO 7-1

**Per ISO 296 type BEK

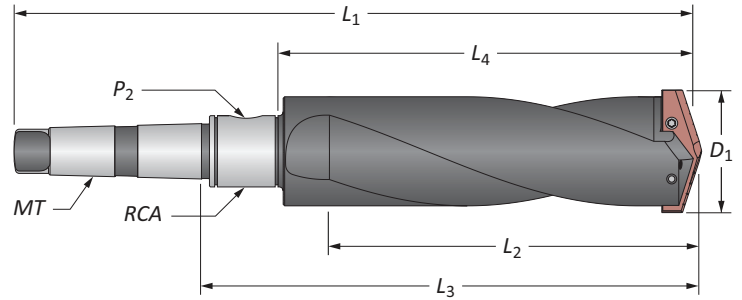

Helical Flute

	Length	D ₁	Body				Shank			Part No.
			L ₂	L ₄	L ₃	L ₁	MT	P ₂	RCA	
m	Standard	90.0 - 114.0	273.1	327.0	398.5	541.3	#5**	1/2*	2T-6SRM	24070H-005M

*Metric thread to BSP and ISO 7-1

**Per ISO 296 type BEK

Connection Accessories

Insert Screws	Nylon Locking Screws	Insert Driver	Preset Torque Hand Driver	Replacement Tips	Admissible Tightening Torque*
7619-IP25-1	-	8IP-25	-	-	155.0 in-lbs (1750 N-cm)

*Tightening torques are calculated with a friction coefficient of $\mu = 0.14$ and develop 90% of ultimate yield strength

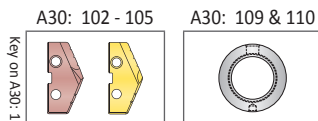

Key on A30-1

i = Imperial (in)
m = Metric (mm)

Screws sold in quantities of 10

WARNING Refer to Speed and Feed charts for recommended adjustments to speeds and feeds. Refer to page A30: 146 for deep hole drilling guidelines in this section of the catalog. Visit www.alliedmachine.com/DeepHoleGuidelines for the most up-to-date information and procedures. Factory technical assistance is available for your specific applications through our Application Engineering Team.

A DRILLING
B BORING
C REAMING
D BURNISHING
E THREADING
X SPECIALS

T-A Drill Insert Holders

7 Series | Straight Shank

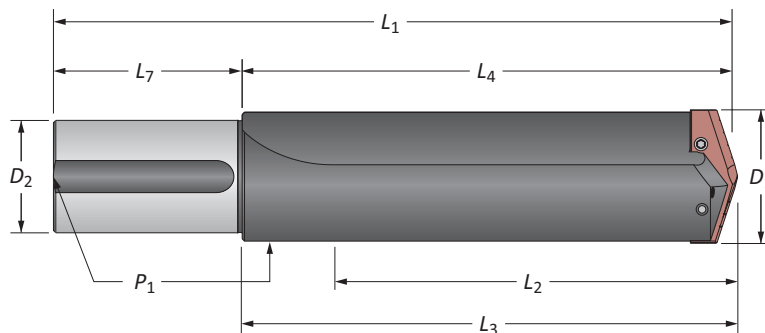

Straight Flute

	Length	Body					Shank			Part No.
		D_1	L_2	L_4	L_3	L_1	D_2	L_7	P_1	
	Short	3-17/32 - 4-1/2	6-3/4	8-7/8	9-1/8	13-7/8	3	5	1/2	22070S-300L
	Standard	3-17/32 - 4-1/2	10-3/4	12-7/8	13-1/8	17-7/8	3	5	1/2	24070S-300L
i	Extended	3-17/32 - 4-1/2	21-7/8	24	24-1/4	29	3	5	1/2	i 25070S-300L
	XL	3-17/32 - 4-1/2	27	29-1/8	29-3/8	34-1/8	3	5	1/2	i 27070S-300L
	3XL	3-17/32 - 4-1/2	37	39-1/8	39-3/8	44-1/8	3	5	1/2	i 29070S-300L

Connection Accessories

Insert Screws	Nylon Locking Screws	Insert Driver	Preset Torque Hand Driver	Replacement Tips	Admissible Tightening Torque*
7619-IP25-1	—	8IP-25	—	—	155.0 in-lbs (1750 N-cm)

*Tightening torques are calculated with a friction coefficient of $\mu = 0.14$ and develop 90% of ultimate yield strength

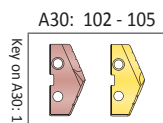

i = Imperial (in)

m = Metric (mm)

Screws sold in quantities of 10

WARNING Refer to Speed and Feed charts for recommended adjustments to speeds and feeds. Refer to page A30: 146 for deep hole drilling guidelines in this section of the catalog. Visit www.alliedmachine.com/DeepHoleGuidelines for the most up-to-date information and procedures. Factory technical assistance is available for your specific applications through our Application Engineering Team.



T-A Drill Accessories

7/8 Series | Rotary Coolant Adapters | Torx® Plus Screws

Rotary Coolant Adapter (RCA) and Accessories

ID	OD	L ₁	Driving Rod Thread	P ₁	Part No.	RCA O-Rings	
						Kit Part No.**	Replacements
i 2-1/4	3-3/4	1-3/4	1/2-13	1/2	⚠ 2T-6SR	2T1-6SR	2T1-6OR-10
m 57.15	95.27	44.45	M12 x 1.75	1/2*	⚠ 2T-6SRM	2T1-6SR	2T1-6OR-10

*Thread to BSP and ISO 7-1

**RCA Repair Kit includes (2) O-rings, (2) snap rings, and (2) thrust washers

⚠ Refer to page A30: 110 for proper RCA assembly and safety information

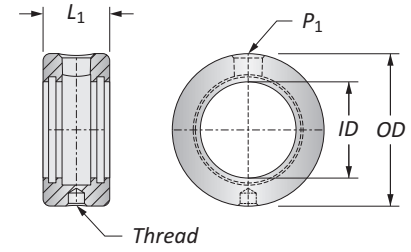

Connection Accessories

Insert Screws	Nylon Locking Screws	Insert Driver	Preset Torque Hand Driver	Replacement Tips	Admissible Tightening Torque*
7619-IP25-1	-	8IP-25	-	-	155.0 in-lbs (1750 N-cm)

*Tightening torques are calculated with a friction coefficient of $\mu = 0.14$ and develop 90% of ultimate yield strength

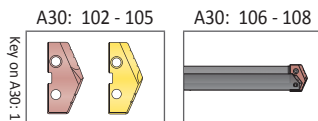

i = Imperial (in)
m = Metric (mm)
 Inserts sold separately
 Screws sold in packs of 10
 O-rings sold in packs of 10

⚠ WARNING Refer to Speed and Feed charts for recommended adjustments to speeds and feeds. Refer to page A30: 146 for deep hole drilling guidelines in this section of the catalog. Visit www.alliedmachine.com/DeepHoleGuidelines for the most up-to-date information and procedures. Factory technical assistance is available for your specific applications through our Application Engineering Team.

Rotary Coolant Adapters (RCA)

Morse Taper Shanks

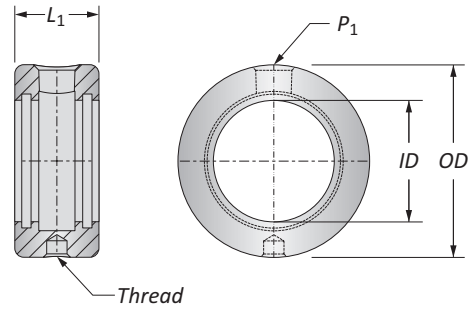

Holder Series	ID	OD	L ₁	Driving Rod Thread	P ₁	Part No.	Max Recommended RPM	RCA O-Rings		
								Kit Part No.**	Replacements	
i	Y, Z, 0	3/4	1-3/4	7/8	5/16 - 18	1/8	⚠ 2T-2SR	3500	2T1-2SR	2T1-2OR-10
	1, 2	1	2-1/8	1-1/8	5/16 - 18	1/8	⚠ 2T-3SR	2500	2T1-3SR	2T1-3OR-10
	2, 3, 4	1-1/4	2-1/2	1-3/8	3/8 - 16	1/4	⚠ 2T-4SR	2000	2T1-4SR	2T1-4OR-10
	3, 4	1-3/4	3	1-3/8	3/8 - 16	1/4	⚠ 2T-5SR	1500	2T1-5SR	2T1-5OR-10
	5, 7	2-1/4	3-3/4	1-3/4	1/2 - 13	1/2	⚠ 2T-6SR	1100	2T1-6SR	2T1-6OR-10
m	Y, Z, 0	19.05	44.45	22.23	M8 x 1.25	1/8*	⚠ 2T-2SRM	3500	2T1-2SR	2T1-2OR-10
	1, 2	25.40	53.97	28.57	M8 x 1.25	1/8*	⚠ 2T-3SRM	2500	2T1-3SR	2T1-3OR-10
	2, 3, 4	31.75	63.50	34.92	M10 x 1.50	1/4*	⚠ 2T-4SRM	2000	2T1-4SR	2T1-4OR-10
	3, 4	44.45	76.20	34.92	M10 x 1.50	1/4*	⚠ 2T-5SRM	1500	2T1-5SR	2T1-5OR-10
	5, 7	57.15	95.27	44.45	M12 x 1.75	1/2*	⚠ 2T-6SRM	1100	2T1-6SR	2T1-6OR-10

*Thread to BSP and ISO 7-1

**RCA Repair Kit includes (2) O-rings, (2) snap rings, and (2) thrust washers

NOTE: Max recommended pressure is 600 PSI (42 bar)

NOTE: Recommendations above are based on water and oil based coolants

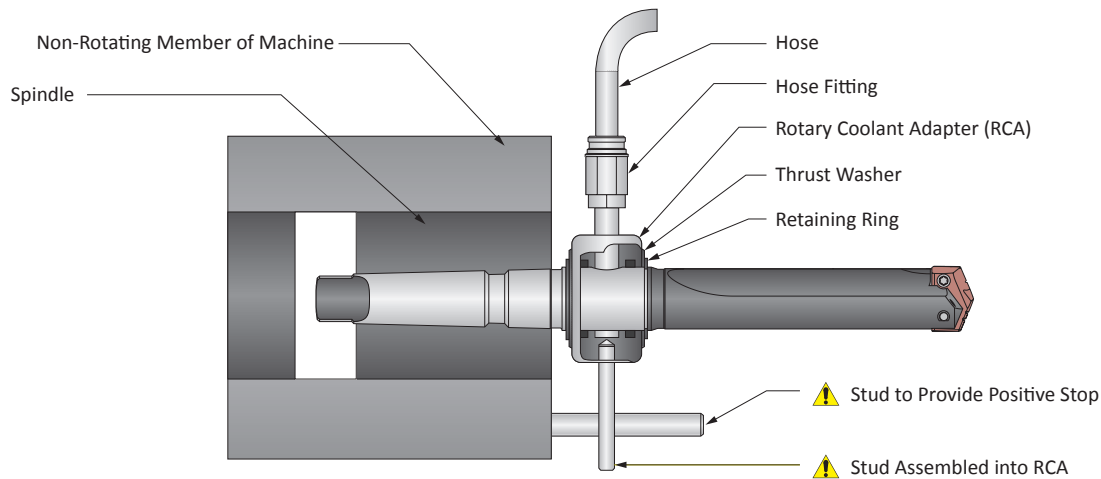

i = Imperial (in)

m = Metric (mm)



O-rings sold in packs of 10

⚠ WARNING RCA rotation during drilling can cause hose and/or hose fitting failure, machinery damage, and/or serious injury. To prevent, use RCA and positive stop studs when drilling. Factory technical assistance is also available for your specific applications.

T-ACR 45 Chamfer Rings

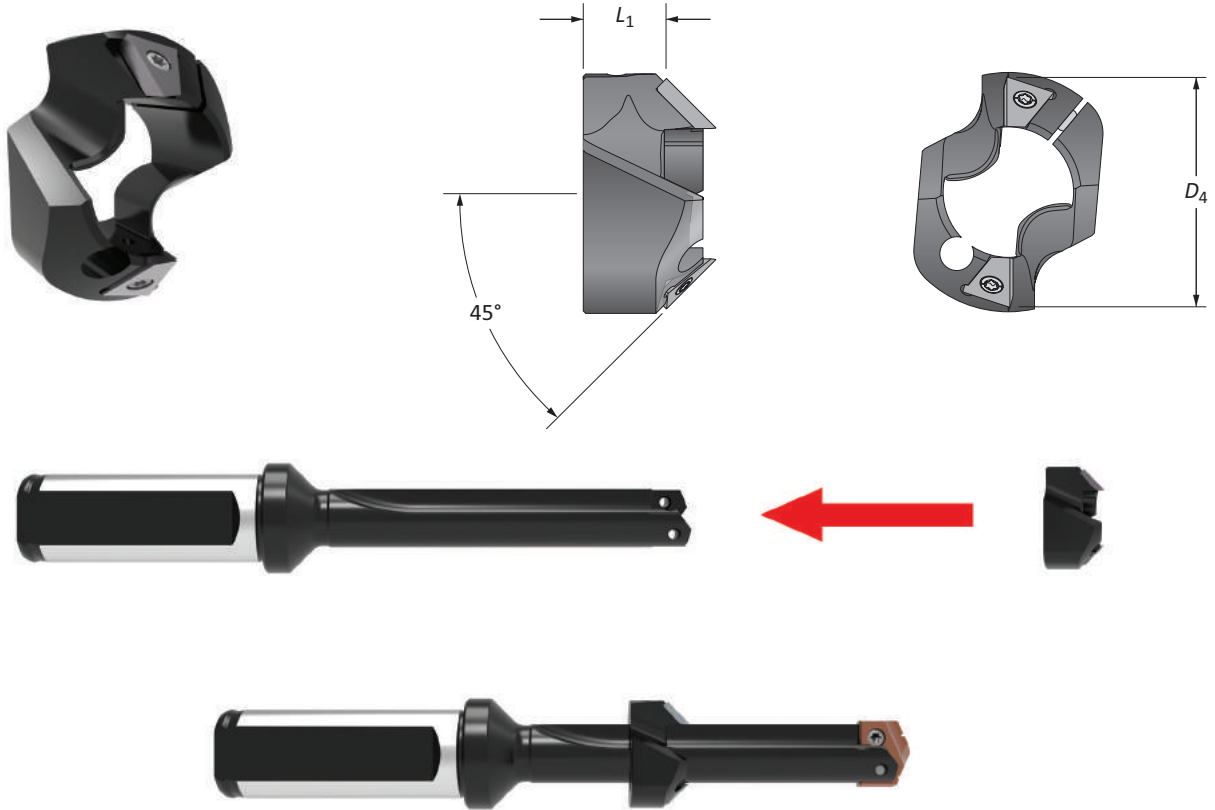
Straight Flute Holders



Holder Series	D ₁ Range	Chamfer Ring		Part No.	 Insert Part No.	 Insert Screw	Insert Driver	 Clamping Screw	Insert Driver
		D ₄	L ₁						
0	0.5118 - 0.6890	13/16	0.676	T-ACR-45-0	T-ACRI-45-B-C5A	7255-IP8-1	8IP-8	7375-IP9-1	8IP-9
1	0.6900 - 0.8540	1-3/64	51/64	T-ACR-45-1	T-ACRI-45-B-C5A	7255-IP8-1	8IP-8	7495-IP15-1	8IP-15
1.5	0.8540 - 0.9600	1-1/8	57/64	T-ACR-45-1.5	T-ACRI-45-B-C5A	7255-IP8-1	8IP-8	7495-IP15-1	8IP-15
2	0.9610 - 1.3800	1-9/16	1	T-ACR-45-2	T-ACRI-45-B-C5A	7255-IP8-1	8IP-8	7514-IP20-1	8IP-20

Highlights and Other Information

- Produces a 45° chamfer only
- Clamping screw allows for setting at any length along the flute
- Double effective cutting with face mounted inserts provides increased feed rates and greater insert strength
- The ring is balanced to match the holder center of gravity to ensure stability
- Inserts only available in C5 carbide and TiAlN coating
- Ideal for short-run or time sensitive jobs that require quick delivery



IMPORTANT: T-A chamfer rings can only be used with straight flute T-A holders

Inserts sold in quantities of 2
Screws sold in quantities of 10

GEN2 T-A Recommended Drilling Data | Imperial (inch)

HSS Inserts

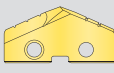
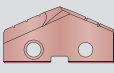
ISO	Material	Hardness (BHN)	HSS Grade	SFM		Feed Rate (IPR) by Diameter	
				 TiN	 AM200®	3/8 - 1/2	33/64 - 11/16
P	Free Machining Steel 1118, 1215, 12L14, etc.	100 - 150	HSS	200	325	0.008	0.012
		150 - 200	HSS	180	300	0.007	0.011
		200 - 250	HSS	160	280	0.006	0.010
	Low Carbon Steel 1010, 1020, 1025, 1522, 1144, etc.	85 - 125	HSS	170	290	0.008 ❖	0.010
		125 - 175	HSS	160	275	0.007 ❖	0.010
		175 - 225	HSS	150	260	0.006 ❖	0.009
	Medium Carbon Steel 1030, 1040, 1050, 1527, 1140, 1151, etc.	225 - 275	HSS	140	240	0.005 ❖	0.009
		125 - 175	HSS	160	275	0.007	0.010
		175 - 225	HSS	150	260	0.006	0.009
	Alloy Steel 4140, 5140, 8640, etc.	225 - 275	HSS	140	240	0.006	0.009
		275 - 325	SC	130	225	0.005	0.008
		325 - 375	SC	110	180	0.004	0.007
275 - 325		SC	120	195	0.005	0.008	
High Strength Alloy 4340, 4330V, 300M, etc.	300 - 350	SC	60	100	0.005 ❖	0.008	
	350 - 400	SC	50	80	0.004 ❖	0.007	
	225 - 300	SC	80	125	0.006 ❖	0.009	
Structural Steel A36, A285, A516, etc.	150 - 250	HSS	140	235	0.008 ❖	0.011	
	250 - 350	SC	100	160	0.005 ❖	0.009	
	100 - 150	HSS	140	235	0.008 ❖	0.011	
Tool Steel H-13, H-21, A-4, O-2, S-3, etc.	150 - 200	SC	80	125	0.004	0.007	
	200 - 250	SC	60	105	0.004	0.007	
S	High Temp Alloy Hastelloy B, Inconel 600, etc.	140 - 220	SC	30	45	0.004 ❖	0.007
		220 - 310	SC	25	40	0.004 ❖	0.006
	Titanium Alloy	140 - 220	SC	35	55	0.004 ❖	0.007
		220 - 310	SC	30	50	0.003 ❖	0.006
Aerospace Alloy S82	185 - 275	SC	75	110	0.006 ❖	0.008	
	275 - 350	SC	60	100	0.005 ❖	0.007	
M	Stainless Steel 400 Series 416, 420, etc.	185 - 275	SC	75	110	0.006 ❖	0.008
		275 - 350	SC	60	100	0.005 ❖	0.007
	Stainless Steel 300 Series 304, 316, 17-4PH, etc.	135 - 185	SC	75	110	0.003 ❖	0.007
		185 - 275	SC	60	100	0.003 ❖	0.006
	Super Duplex Stainless Steel	135 - 185	SC	60	85	0.003 ❖	0.007
185 - 275		SC	50	70	0.003 ❖	0.006	
H	Wear Plate Hardox, AR400, T-1, etc.	400	SC	45	70	0.003 ❖	0.006
		500	SC	35	45	0.002 ❖	0.005
		600	-	-	-	0.004 ❖	0.006
	Hardened Steel	300 - 400	SC	50	95	-	-
400 - 500		SC	35	45	0.002 ❖	0.005	
K	Nodular, Grey, Ductile Cast Iron	120 - 150	HSS	170	290	0.008	0.012
		150 - 200	HSS	150	260	0.007	0.011
		200 - 220	HSS	130	225	0.006	0.009
		220 - 260	SC	110	190	0.005	0.008
		260 - 320	SC	90	155	0.005	0.007
N	Cast Aluminum	30	HSS	600	-	0.009	0.015
		180	HSS	300	-	0.008	0.013
	Wrought Aluminum	30	HSS	600	900	0.005	0.013
		180	HSS	300	650	0.005	0.007
	Aluminum Bronze	100 - 200	SC	170	270	0.006	0.009
		200 - 250	SC	130	210	0.005	0.007
	Brass	100	HSS	300	470	0.007	0.011
Copper	60	SC	130	190	0.003 ❖	0.004	

❖ Contact our Application Engineering department for assistance when machining these materials

IMPORTANT: The speeds and feeds listed above are a general starting point for all applications. Refer to the Coolant Recommendation charts for coolant requirements to run at the recommended speeds and feeds. Factory technical assistance is available through our Application Engineering department. See adjustment examples on the following page.

Feed Rate (IPR) by Diameter				
45/64 - 15/16	31/32 - 1-3/8	1-13/32 - 1-7/8	1-29/32 - 2-9/16	2-19/32 - 4-1/2
0.016	0.019	0.020	0.023	0.028
0.015	0.017	0.020	0.023	0.028
0.014	0.016	0.020	0.023	0.028
0.014	0.018	0.019	0.023	0.027
0.014	0.017	0.019	0.023	0.027
0.013	0.016	0.018	0.021	0.024
0.013	0.016	0.018	0.021	0.024
0.014	0.017	0.019	0.023	0.027
0.013	0.016	0.018	0.021	0.024
0.013	0.016	0.018	0.021	0.024
0.012	0.015	0.016	0.019	0.022
0.014	0.017	0.017	0.019	0.022
0.013	0.016	0.017	0.019	0.022
0.013	0.016	0.017	0.019	0.022
0.012	0.015	0.015	0.017	0.020
0.011	0.014	0.015	0.017	0.020
0.011	0.013	0.014	0.017	0.020
0.010	0.012	0.014	0.017	0.020
0.009	0.011	0.012	0.015	0.018
0.015	0.017	0.018	0.021	0.026
0.013	0.015	0.016	0.019	0.024
0.012	0.013	0.014	0.017	0.020
0.010	0.012	0.012	0.015	0.017
0.010	0.012	0.012	0.015	0.017
0.009	0.011	0.012	0.015	0.017
0.008	0.010	0.010	0.012	0.014
0.008	0.010	0.012	0.015	0.017
0.007	0.009	0.010	0.012	0.014
0.009	0.011	0.014	0.016	0.020
0.008	0.010	0.012	0.014	0.018
0.009	0.011	0.014	0.016	0.020
0.008	0.010	0.012	0.014	0.018
0.009	0.011	0.014	0.016	0.020
0.008	0.010	0.012	0.014	0.018
0.008	0.009	0.012	0.016	0.018
0.007	0.008	0.010	0.012	0.016
0.009	0.011	0.012	0.016	0.018
-	-	-	-	-
0.007	0.009	0.010	0.012	0.016
0.016	0.020	0.024	0.027	0.030
0.015	0.019	0.022	0.025	0.028
0.013	0.017	0.018	0.021	0.024
0.011	0.014	0.014	0.017	0.020
0.010	0.012	0.012	0.014	0.016
0.018	0.023	0.022	0.025	0.025
0.016	0.020	0.022	0.025	0.025
0.016	0.020	0.022	0.025	0.025
0.012	0.014	0.022	0.025	0.025
0.012	0.015	0.017	0.019	0.021
0.009	0.011	0.014	0.016	0.018
0.013	0.018	0.019	0.021	0.023
0.007	0.010	0.009	0.011	0.012

Deep Hole Drilling Speed and Feed Adjustment

	Holder Length				
	Extended	Long	Long Plus	XL	3XL
Speed	0.90	0.85	0.80	0.80	0.75
Feed	-	0.95	0.90	0.90	0.90

Recommended Speed and Feed Example

If the recommended speed and feed is 200 SFM and 0.008 IPR for a standard length holder, then the speed and feed using a 3XL holder in the same application would be 150 SFM and 0.007 IPR.

$200 \cdot 0.75 = 150 \text{ SFM}$ $0.008 \cdot 0.90 = 0.007 \text{ IPR}$

Formulas

- RPM = (3.82 • SFM) / DIA**

where:

 - RPM = revolutions per minute (rev/min)
 - SFM = speed (ft/min)
 - DIA = diameter of drill (inch)
- IPM = RPM • IPR**

where:

 - IPM = inches per minute (in/min)
 - RPM = revolutions per minute (rev/min)
 - IPR = feed rate (in/rev)
- SFM = RPM • 0.262 • DIA**

where:

 - SFM = speed (ft/min)
 - RPM = revolutions per minute (rev/min)
 - DIA = diameter of drill (inch)

⚠ WARNING Tool failure can cause serious injury. To prevent:

- When using holders without support bushing, use a short T-A® holder to establish an initial hole that is a minimum of 2 diameters deep.
- Do not rotate tool holder more than 50 RPM unless it is engaged with the workpiece or fixture.

Visit www.alliedmachine.com/DeepHoleGuidelines for the most up-to-date information and procedures. Factory technical assistance is available for your specific applications through our Application Engineering Team.

GEN2 T-A Recommended Drilling Data | Imperial (inch)

Carbide Inserts

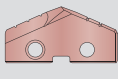
ISO	Material	Hardness (BHN)	Carbide Grade	SFM  AM200®	Feed Rate (IPR) by Diameter			
					3/8 - 1/2	33/64 - 11/16	45/64 - 15/16	31/32 - 1-3/8
P	Free Machining Steel 1118, 1215, 12L14, etc.	100 - 150	C1	480	0.008	0.012	0.016	0.019
		150 - 200	C1	415	0.007	0.011	0.015	0.017
		200 - 250	C1	390	0.006	0.010	0.014	0.016
	Low Carbon Steel 1010, 1020, 1025, 1522, 1144, etc.	85 - 125	C1	450	0.008 ❖	0.010	0.014	0.018
		125 - 175	C1	390	0.007 ❖	0.010	0.014	0.017
		175 - 225	C1	355	0.006 ❖	0.009	0.013	0.016
		225 - 275	C1	310	0.005 ❖	0.009	0.013	0.016
	Medium Carbon Steel 1030, 1040, 1050, 1527, 1140, 1151, etc.	125 - 175	C1	390	0.007	0.010	0.014	0.017
		175 - 225	C1	355	0.006	0.009	0.013	0.016
		225 - 275	C1	310	0.006	0.009	0.013	0.016
		275 - 325	C1	265	0.005	0.008	0.012	0.015
	Alloy Steel 4140, 5140, 8640, etc.	125 - 175	C1	375	0.007	0.010	0.014	0.017
175 - 225		C1	345	0.006	0.009	0.013	0.016	
225 - 275		C1	310	0.006	0.009	0.013	0.016	
275 - 325		C1	285	0.005	0.008	0.012	0.015	
325 - 375		C1	255	0.004	0.007	0.011	0.014	
High Strength Alloy 4340, 4330V, 300M, etc.	225 - 300	C1	230	0.006 ❖	0.009	0.011	0.013	
	300 - 350	C1	205	0.005 ❖	0.008	0.010	0.012	
	350 - 400	C1	185	0.004 ❖	0.007	0.009	0.011	
Structural Steel A36, A285, A516, etc.	100 - 150	C1	355	0.008 ❖	0.011	0.015	0.017	
	150 - 250	C1	285	0.006 ❖	0.010	0.013	0.015	
	250 - 350	C1	265	0.005 ❖	0.009	0.012	0.013	
Tool Steel H-13, H-21, A-4, O-2, S-3, etc.	150 - 200	C1	255	0.007	0.007	0.010	0.012	
	200 - 250	C1	195	0.007	0.007	0.010	0.012	
S	High Temp Alloy Hastelloy B, Inconel 600, etc.	140 - 220	C2	120	0.004 ❖	0.007	0.009	0.011
		220 - 310	C2	95	0.004 ❖	0.006	0.008	0.010
	Titanium Alloy	140 - 220	C2	140	0.004 ❖	0.007	0.008	0.011
		220 - 310	C2	110	0.003 ❖	0.006	0.007	0.009
	Aerospace Alloy S82	185 - 275	C2	240	0.005 ❖	0.006	0.007	0.009
275 - 350		C2	180	0.004 ❖	0.005	0.006	0.008	
M	Stainless Steel 400 Series 416, 420, etc.	185 - 275	C2	240	0.007 ❖	0.009	0.012	0.014
		275 - 350	C2	180	0.006 ❖	0.008	0.011	0.012
	Stainless Steel 300 Series 304, 316, 17-4PH, etc.	135 - 185	C2	240	0.006 ❖	0.007	0.009	0.012
		185 - 275	C2	180	0.005 ❖	0.006	0.008	0.009
	Super Duplex Stainless Steel	135 - 185	C2	125	0.005 ❖	0.007	0.008	0.010
185 - 275		C2	100	0.004 ❖	0.006	0.007	0.009	

❖ Contact our Application Engineering department for assistance when machining these materials

IMPORTANT: The speeds and feeds listed above are a general starting point for all applications. Refer to the Coolant Recommendation charts for coolant requirements to run at the recommended speeds and feeds. Factory technical assistance is available through our Application Engineering department. See adjustment examples on the following page.

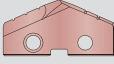
ISO	Material	Hardness (BHN)	HSS Grade	SFM	Feed Rate (IPR) by Diameter			
				 AM200®	3/8 - 1/2	33/64 - 11/16	45/64 - 15/16	31/32 - 1-3/8
H	Wear Plate Hardox, AR400, T-1, etc.	400	C2	150	0.003 ❖	0.005	0.008	0.010
		500	C2	120	0.002 ❖	0.004	0.006	0.008
		600	C2	100	0.001 ❖	0.003	0.005	0.006
	Hardened Steel	300 - 400	C1	150	0.004 ❖	0.006	0.009	0.011
400 - 500		C1	120	0.003 ❖	0.005	0.008	0.010	
K	Nodular, Grey, Ductile Cast Iron	120 - 150	C2	500	0.008	0.012	0.015	0.019
		150 - 200	C2	480	0.007	0.011	0.013	0.017
		200 - 220	C2	430	0.006	0.009	0.012	0.015
		220 - 260	C2	370	0.005	0.008	0.011	0.013
		260 - 320	C2	335	0.005	0.007	0.010	0.011
N	Cast Aluminum	30	C2	975	0.009	0.015	0.018	0.023
		180	C2	730	0.008	0.013	0.016	0.020
	Wrought Aluminum	30	C2	1385	0.005	0.013	0.016	0.020
		180	C2	975	0.005	0.007	0.012	0.014
	Aluminum Bronze	100 - 200	C2	360	0.006	0.009	0.012	0.015
		200 - 250	C2	300	0.005	0.007	0.009	0.011
	Brass	100	C2	650	0.007	0.011	0.013	0.018
Copper	60	C2	420	0.003 ❖	0.004	0.007	0.010	

❖ Contact our our Application Engineering department for assistance when machining these materials

Deep Hole Drilling Speed and Feed Adjustment

	⚠ Holder Length				
	Extended	Long	Long Plus	XL	3XL
Speed	0.90	0.85	0.80	0.80	0.75
Feed	-	0.95	0.90	0.90	0.90

Recommended Speed and Feed Example

If the recommended speed and feed is 200 SFM and 0.008 IPR for a standard length holder, then the speed and feed using a 3XL holder in the same application would be 150 SFM and 0.007 IPR.

$200 \cdot 0.75 = 150 \text{ SFM}$	$0.008 \cdot 0.90 = 0.007 \text{ IPR}$
------------------------------------	--

Formulas

<p>1. $RPM = (3.82 \cdot SFM) / DIA$</p> <p>where:</p> <ul style="list-style-type: none"> RPM = revolutions per minute (rev/min) SFM = speed (ft/min) DIA = diameter of drill (inch) 	<p>2. $IPM = RPM \cdot IPR$</p> <p>where:</p> <ul style="list-style-type: none"> IPM = inches per minute (in/min) RPM = revolutions per minute (rev/min) IPR = feed rate (in/rev) 	<p>3. $SFM = RPM \cdot 0.262 \cdot DIA$</p> <p>where:</p> <ul style="list-style-type: none"> SFM = speed (ft/min) RPM = revolutions per minute (rev/min) DIA = diameter of drill (inch)
--	---	---

⚠ WARNING Tool failure can cause serious injury. To prevent:



- When using holders without support bushing, use a short T-A® holder to establish an initial hole that is a minimum of 2 diameters deep.
- Do not rotate tool holder more than 50 RPM unless it is engaged with the workpiece or fixture.

Visit www.alliedmachine.com/DeepHoleGuidelines for the most up-to-date information and procedures. Factory technical assistance is available for your specific applications through our Application Engineering Team.

A
DRILLING
B
BORING
C
REAMING
D
BURNISHING
E
THREADING
X
SPECIALS

Original T-A Recommended Drilling Data | Imperial (inch)

HSS Inserts

ISO	Material	Hardness (BHN)	HSS Grade	SFM			Feed Rate (IPR) by Diameter	
				 TiN	 TiAlN	 TiCN	3/8 - 1/2	33/64 - 11/16
P	Free Machining Steel 1118, 1215, 12L14, etc.	100 - 150	HSS	200	280	260	0.007	0.010
		150 - 200	HSS	180	260	235	0.007	0.010
		200 - 250	HSS	160	240	210	0.006	0.010
	Low Carbon Steel 1010, 1020, 1025, 1522, 1144, etc.	85 - 125	HSS	170	250	220	0.006 ❖	0.009
		125 - 175	HSS	160	240	210	0.006 ❖	0.009
		175 - 225	HSS	150	225	195	0.005 ❖	0.008
	Medium Carbon Steel 1030, 1040, 1050, 1527, 1140, 1151, etc.	225 - 275	HSS	140	210	180	0.005 ❖	0.008
		125 - 175	HSS	160	240	210	0.006	0.009
		175 - 225	HSS	150	225	195	0.005	0.008
	Alloy Steel 4140, 5140, 8640, etc.	225 - 275	HSS	140	210	180	0.005	0.008
		275 - 325	SC, PC	130	195	170	0.004	0.007
		325 - 375	SC, PC	110	155	145	0.003	0.006
High Strength Alloy 4340, 4330V, 300M, etc.	225 - 300	SC, PC	80	110	100	0.005 ❖	0.007	
	300 - 350	SC, PC	60	85	80	0.004 ❖	0.007	
	350 - 400	PC	50	70	65	0.003 ❖	0.006	
Structural Steel A36, A285, A516, etc.	100 - 150	HSS	140	200	180	0.006 ❖	0.010	
	150 - 250	HSS	120	170	155	0.005 ❖	0.009	
	250 - 350	SC, PC	100	140	130	0.003 ❖	0.008	
Tool Steel H-13, H-21, A-4, O-2, S-3, etc.	150 - 200	SC	80	110	105	0.004	0.006	
	200 - 250	SC, PC	60	90	85	0.004	0.006	
S	High Temp Alloy Hastelloy B, Inconel 600, etc.	140 - 220	SC, PC	30	40	35	0.003 ❖	0.007
		220 - 310	PC	25	35	30	0.003 ❖	0.006
	Titanium Alloy	140 - 220	SC, PC	35	50	45	0.003 ❖	0.007
		220 - 310	PC	30	45	35	0.003 ❖	0.006
Aerospace Alloy S82	185 - 275	SC, PC	75	105	95	0.006 ❖	0.008	
	275 - 350	SC, PC	60	90	80	0.005 ❖	0.007	
M	Stainless Steel 400 Series 416, 420, etc.	185 - 275	SC, PC	75	105	95	0.009	0.010
		275 - 350	SC, PC	60	90	80	0.008	0.009
	Stainless Steel 300 Series 304, 316, 17-4PH, etc.	135 - 185	SC, PC	75	105	95	0.007	0.007
		185 - 275	SC, PC	60	90	80	0.006	0.006
	Super Duplex Stainless Steel	135 - 185	SC, PC	60	80	70	0.005	0.005
185 - 275		SC, PC	50	65	60	0.004	0.005	
H	Wear Plate Hardox, AR400, T-1, etc.	400	SC, PC	45	70	55	0.003 ❖	0.006
		500	PC	35	45	40	0.002 ❖	0.005
		600	N/A	-	-	-	-	-
	Hardened Steel	300 - 400	PC	50	95	70	0.003 ❖	0.006
400 - 500		PC	35	45	40	0.002 ❖	0.005	
K	Nodular, Grey, Ductile Cast Iron	120 - 150	HSS	170	250	220	0.007	0.012
		150 - 200	HSS	150	225	195	0.006	0.011
		200 - 220	HSS	130	195	170	0.006	0.009
		220 - 260	SC, PC	110	165	145	0.005	0.007
		260 - 320	SC, PC	90	135	120	0.004	0.006
N	Cast Aluminum	30	HSS	600	850	750	0.008	0.013
		180	HSS	300	450	400	0.008	0.013
	Wrought Aluminum	30	HSS	600	850	750	0.004	0.006
		180	HSS	300	450	400	0.008	0.013
	Aluminum Bronze	100 - 200	SC	170	250	220	0.006	0.011
		200 - 250	SC	130	190	170	0.005	0.007
	Brass	100	HSS	300	445	400	0.007	0.012
Copper	60	SC	130	165	150	0.002 ❖	0.003	

❖ Contact our Application Engineering department for assistance when machining these materials

IMPORTANT: The speeds and feeds listed above are a general starting point for all applications. Refer to the Coolant Recommendation charts for coolant requirements to run at the recommended speeds and feeds. Factory technical assistance is available through our Application Engineering department. See adjustment examples on the following page.

Feed Rate (IPR) by Diameter				
45/64 - 15/16	31/32 - 1-3/8	1-13/32 - 1-7/8	1-29/32 - 2-9/16	2-19/32 - 4-1/2
0.013	0.016	0.020	0.023	0.028
0.013	0.016	0.020	0.023	0.028
0.013	0.016	0.020	0.023	0.028
0.012	0.015	0.019	0.023	0.027
0.012	0.015	0.019	0.023	0.027
0.010	0.014	0.018	0.021	0.024
0.010	0.014	0.018	0.021	0.024
0.012	0.015	0.019	0.023	0.027
0.010	0.014	0.018	0.021	0.024
0.010	0.014	0.018	0.021	0.024
0.009	0.012	0.016	0.019	0.022
0.010	0.014	0.017	0.019	0.022
0.010	0.014	0.017	0.019	0.022
0.010	0.014	0.017	0.019	0.022
0.009	0.012	0.015	0.017	0.020
0.009	0.012	0.015	0.017	0.020
0.009	0.010	0.014	0.017	0.020
0.009	0.010	0.014	0.017	0.020
0.008	0.009	0.012	0.015	0.018
0.012	0.014	0.018	0.021	0.026
0.010	0.012	0.016	0.019	0.024
0.009	0.010	0.014	0.017	0.020
0.008	0.010	0.012	0.015	0.017
0.008	0.010	0.012	0.015	0.017
0.008	0.010	0.012	0.015	-
0.007	0.008	0.010	0.012	-
0.008	0.010	0.012	0.015	-
0.007	0.008	0.010	0.012	-
0.009	0.010	0.014	0.016	0.020
0.008	0.008	0.012	0.014	0.018
0.011	0.012	0.013	0.014	0.015
0.010	0.011	0.012	0.013	0.014
0.008	0.008	0.009	0.009	0.010
0.007	0.007	0.008	0.008	0.009
0.006	0.006	0.007	0.008	0.008
0.005	0.006	0.006	0.007	0.007
0.008	0.009	0.012	0.016	0.018
0.007	0.008	0.010	0.012	0.016
-	-	-	-	-
0.008	0.009	0.012	0.016	0.018
0.007	0.008	0.010	0.012	0.016
0.016	0.020	0.024	0.027	0.030
0.014	0.018	0.022	0.025	0.028
0.012	0.016	0.018	0.021	0.024
0.009	0.012	0.014	0.017	0.020
0.007	0.009	0.012	0.014	0.016
0.016	0.020	0.022	0.025	0.025
0.016	0.018	0.022	0.025	0.025
0.010	0.012	0.022	0.025	0.025
0.016	0.018	0.022	0.025	0.025
0.014	0.018	0.022	0.026	0.028
0.009	0.012	0.014	0.017	0.020
0.016	0.020	0.024	0.028	0.030
0.006	0.008	0.012	0.014	0.016

Deep Hole Drilling Speed and Feed Adjustment

	Holder Length				
	Extended	Long	Long Plus	XL	3XL
Speed	0.90	0.85	0.80	0.80	0.75
Feed	-	0.95	0.90	0.90	0.90

Recommended Speed and Feed Example

If the recommended speed and feed is 200 SFM and 0.008 IPR for a standard length holder, then the speed and feed using a 3XL holder in the same application would be 150 SFM and 0.007 IPR.

$200 \cdot 0.75 = 150 \text{ SFM}$ $0.008 \cdot 0.90 = 0.007 \text{ IPR}$

Formulas

- RPM = (3.82 • SFM) / DIA**

where:

 - RPM = revolutions per minute (rev/min)
 - SFM = speed (ft/min)
 - DIA = diameter of drill (inch)
- IPM = RPM • IPR**

where:

 - IPM = inches per minute (in/min)
 - RPM = revolutions per minute (rev/min)
 - IPR = feed rate (in/rev)
- SFM = RPM • 0.262 • DIA**

where:

 - SFM = speed (ft/min)
 - RPM = revolutions per minute (rev/min)
 - DIA = diameter of drill (inch)



⚠ WARNING Tool failure can cause serious injury. To prevent:

- When using holders without support bushing, use a short T-A® holder to establish an initial hole that is a minimum of 2 diameters deep.
- Do not rotate tool holder more than 50 RPM unless it is engaged with the workpiece or fixture.

Visit www.alliedmachine.com/DeepHoleGuidelines for the most up-to-date information and procedures. Factory technical assistance is available for your specific applications through our Application Engineering Team.



Original T-A Recommended Drilling Data | Imperial (inch)

Carbide Inserts

ISO	Material	Hardness (BHN)	Carbide Grade	SFM			Feed Rate (IPR) by Diameter				
				 TiN	 TiAlN	 TiCN	3/8 - 1/2	33/64 - 11/16	45/64 - 15/16	31/32 - 1-3/8	1-13/32 - 1-7/8
P	Free Machining Steel 1118, 1215, 12L14, etc.	100 - 150	C5	320	420	375	0.008	0.012	0.015	0.018	0.021
		150 - 200	C5	280	360	325	0.007	0.011	0.014	0.016	0.019
		200 - 250	C5	260	340	295	0.006	0.010	0.013	0.015	0.017
	Low Carbon Steel 1010, 1020, 1025, 1522, 1144, etc.	85 - 125	C5	300	390	360	0.008 ❖	0.010	0.013	0.017	0.019
		125 - 175	C5	260	340	295	0.007 ❖	0.010	0.013	0.016	0.018
		175 - 225	C5	240	310	270	0.006 ❖	0.009	0.012	0.015	0.017
	Medium Carbon Steel 1030, 1040, 1050, 1527, 1140, 1151, etc.	125 - 175	C5	260	340	295	0.007	0.010	0.013	0.016	0.018
		175 - 225	C5	240	310	275	0.006	0.009	0.012	0.015	0.017
		225 - 275	C5	210	270	235	0.006	0.009	0.012	0.015	0.017
	Alloy Steel 4140, 5140, 8640, etc.	275 - 325	C5	180	230	205	0.005	0.008	0.011	0.014	0.016
		125 - 175	C5	250	325	285	0.007	0.010	0.013	0.016	0.018
		175 - 225	C5	230	300	260	0.006	0.009	0.012	0.015	0.017
225 - 275		C5	210	270	235	0.006	0.009	0.012	0.015	0.017	
275 - 325		C5	200	250	225	0.005	0.008	0.011	0.014	0.016	
High Strength Alloy 4340, 4330V, 300M, etc.	325 - 375	C5	170	220	195	0.004	0.007	0.010	0.013	0.015	
	225 - 300	C5	160	200	180	0.006 ❖	0.009	0.010	0.012	0.015	
	300 - 350	C5	140	180	160	0.005 ❖	0.008	0.009	0.011	0.014	
Structural Steel A36, A285, A516, etc.	350 - 400	C5	120	160	140	0.004 ❖	0.007	0.008	0.010	0.012	
	100 - 150	C5	240	310	275	0.008 ❖	0.011	0.014	0.016	0.018	
	150 - 250	C5	200	250	225	0.006 ❖	0.010	0.012	0.014	0.016	
Tool Steel H-13, H-21, A-4, O-2, S-3, etc.	250 - 350	C5	180	230	205	0.005 ❖	0.009	0.011	0.012	0.014	
	150 - 200	C5	160	220	190	0.004	0.007	0.009	0.011	0.013	
200 - 250	C5	120	170	145	0.004	0.007	0.009	0.011	0.013		
	S	High Temp Alloy Hastelloy B, Inconel 600, etc.	140 - 220	C2	80	105	90	0.004 ❖	0.007	0.009	0.011
220 - 310		C2	60	85	70	0.004 ❖	0.006	0.008	0.010	0.012	
Titanium Alloy		140 - 220	C2	100	125	105	0.004 ❖	0.007	0.009	0.011	0.013
		220 - 310	C2	80	110	90	0.004 ❖	0.006	0.008	0.010	0.012
Aerospace Alloy S82		185 - 275	C2	160	210	185	0.007 ❖	0.006	0.011	0.014	0.016
	275 - 350	C2	120	160	140	0.006 ❖	0.008	0.010	0.012	0.014	
M	Stainless Steel 400 Series 416, 420, etc.	185 - 275	C2	160	210	185	0.007 ❖	0.008	0.011	0.014	0.016
		275 - 350	C2	120	160	140	0.006 ❖	0.007	0.010	0.012	0.014
	Stainless Steel 300 Series 304, 316, 17-4PH, etc.	135 - 185	C2	160	210	185	0.005 ❖	0.007	0.009	0.010	0.012
		185 - 275	C2	120	160	140	0.004 ❖	0.006	0.008	0.009	0.010
	Super Duplex Stainless Steel	135 - 185	C2	80	110	95	0.004 ❖	0.007	0.008	0.009	0.011
185 - 275		C2	60	80	70	0.003 ❖	0.006	0.007	0.008	0.009	

❖ Contact our Application Engineering department for assistance when machining these materials

IMPORTANT: The speeds and feeds listed above are a general starting point for all applications. Refer to the Coolant Recommendation charts for coolant requirements to run at the recommended speeds and feeds. Factory technical assistance is available through our Application Engineering department. See adjustment examples on the following page.

ISO	Material	Hardness (BHN)	Carbide Grade	SFM			Feed Rate (IPR) by Diameter				
				 TiN	 TiAlN	 TiCN	3/8 - 1/2	33/64 - 11/16	45/64 - 15/16	31/32 - 1-3/8	1-13/32 - 1-7/8
H	Wear Plate Hardox, AR400, T-1, etc.	400	C5	75	115	100	0.003 ❖	0.006	0.008	0.010	0.012
		500	C5	50	85	70	0.002 ❖	0.005	0.006	0.008	0.010
		600	C5	35	75	55	0.001 ❖	0.004	0.005	0.006	0.008
	Hardened Steel	300 - 400	C5	110	140	130	0.004 ❖	0.006	0.009	0.011	0.013
		400 - 500	C5	65	85	75	0.003 ❖	0.005	0.008	0.009	0.011
K	Nodular, Grey, Ductile Cast Iron	120 - 150	C2, C3	320	460	415	0.008	0.012	0.015	0.019	0.023
		150 - 200	C2, C3	270	400	335	0.007	0.011	0.013	0.017	0.021
		200 - 220	C2, C3	240	360	305	0.006	0.009	0.012	0.015	0.018
		220 - 260	C2, C3	210	310	260	0.005	0.008	0.011	0.013	0.015
		260 - 320	C2, C3	180	270	225	0.005	0.007	0.010	0.011	0.013
N	Cast Aluminum	30	C2	1200	1500	1330	0.010	0.013	0.018	0.020	0.022
		180	C2	800	1000	900	0.009	0.013	0.016	0.018	0.020
	Wrought Aluminum	30	C2	1200	1500	1330	0.004	0.006	0.010	0.012	0.014
		180	C2	800	1000	900	0.008	0.013	0.014	0.018	0.020
	Aluminum Bronze	100 - 200	C2	275	360	325	0.005	0.008	0.010	0.014	0.017
		200 - 250	C2	210	305	260	0.004	0.007	0.007	0.010	0.013
	Brass	100	C2	425	600	520	0.006	0.009	0.011	0.015	0.018
	Copper	60	C2	260	390	325	0.002 ❖	0.003	0.004	0.006	0.010

❖ Contact our our Application Engineering department for assistance when machining these materials

Deep Hole Drilling Speed and Feed Adjustment

	⚠ Holder Length				
	Extended	Long	Long Plus	XL	3XL
Speed	0.90	0.85	0.80	0.80	0.75
Feed	-	0.95	0.90	0.90	0.90

Recommended Speed and Feed Example

If the recommended speed and feed is 200 SFM and 0.008 IPR for a standard length holder, then the speed and feed using a 3XL holder in the same application would be 150 SFM and 0.007 IPR.

$200 \cdot 0.75 = 150 \text{ SFM}$	$0.008 \cdot 0.90 = 0.007 \text{ IPR}$
------------------------------------	--

Formulas

1. $RPM = (3.82 \cdot SFM) / DIA$ where: RPM = revolutions per minute (rev/min) SFM = speed (ft/min) DIA = diameter of drill (inch)	2. $IPM = RPM \cdot IPR$ where: IPM = inches per minute (in/min) RPM = revolutions per minute (rev/min) IPR = feed rate (in/rev)	3. $SFM = RPM \cdot 0.262 \cdot DIA$ where: SFM = speed (ft/min) RPM = revolutions per minute (rev/min) DIA = diameter of drill (inch)
---	--	--





⚠ WARNING Tool failure can cause serious injury. To prevent:

- When using holders without support bushing, use a short T-A® holder to establish an initial hole that is a minimum of 2 diameters deep.
- Do not rotate tool holder more than 50 RPM unless it is engaged with the workpiece or fixture.

Visit www.alliedmachine.com/DeepHoleGuidelines for the most up-to-date information and procedures. Factory technical assistance is available for your specific applications through our Application Engineering Team.

Original T-A Recommended Drilling Data | Imperial (inch)

HSS Inserts | Flat Bottom Geometry

ISO	Material	Hardness (BHN)	HSS Grade	SFM			
				 TIN	 TiAlN	 TiCN	 AM200®
P	Free Machining Steel 1118, 1215, 12L14, etc.	100 - 150	HSS	170	250	230	290
		150 - 200	HSS	155	230	205	265
		200 - 250	HSS	140	210	185	245
	Low Carbon Steel 1010, 1020, 1025, 1522, 1144, etc.	85 - 125	HSS	150	220	195	255
		125 - 175	HSS	140	210	185	245
		175 - 225	HSS	130	195	175	225
		225 - 275	HSS	120	185	155	215
	Medium Carbon Steel 1030, 1040, 1050, 1527, 1140, 1151, etc.	125 - 175	HSS	140	210	185	245
		175 - 225	HSS	130	195	175	225
		225 - 275	HSS	120	185	155	215
		275 - 325	SC	110	175	150	205
	Alloy Steel 4140, 5140, 8640, etc.	125 - 175	HSS	130	185	175	215
175 - 225		HSS	120	175	155	205	
225 - 275		HSS	110	155	145	180	
275 - 325		SC	105	145	135	170	
High Strength Alloy 4340, 4330V, 300M, etc.	225 - 300	SC	70	95	85	110	
	300 - 350	SC	50	75	70	90	
	350 - 400	SC	45	65	60	75	
Structural Steel A36, A285, A516, etc.	100 - 150	HSS	120	170	155	195	
	150 - 250	HSS	105	145	135	170	
	250 - 350	SC	85	120	110	140	
Tool Steel H-13, H-21, A-4, O-2, S-3, etc.	150 - 200	SC	70	95	90	110	
	200 - 250	SC	50	80	75	95	
S	High Temp Alloy Hastelloy B, Inconel 600, etc.	140 - 220	SC	25	35	30	40
		220 - 310	SC	20	30	25	35
	Titanium Alloy	140 - 220	SC	35	45	40	50
		220 - 310	SC	26	40	35	45
	Aerospace Alloy S82	185 - 275	SC	65	90	85	110
275 - 350	SC	50	80	70	90		
M	Stainless Steel 400 Series 416, 420, etc.	185 - 275	SC	65	90	85	110
		275 - 350	SC	50	80	70	90
	Stainless Steel 300 Series 304, 316, 17-4PH, etc.	135 - 185	SC	65	90	85	110
		185 - 275	SC	50	80	70	90
	Super Duplex Stainless Steel	135 - 185	SC	65	90	85	110
185 - 275		SC	50	80	70	90	
H	Wear Plate Hardox, AR400, T-1, etc.	400	SC	-	-	-	-
		500	SC	-	-	-	-
		600	N/A	-	-	-	-
	Hardened Steel	300 - 400	SC	45	65	60	80
400 - 500		SC	25	40	35	45	
K	Nodular, Grey, Ductile Cast Iron	120 - 150	HSS	150	220	195	255
		150 - 200	HSS	130	195	175	225
		200 - 220	HSS	110	175	150	205
		220 - 260	SC	95	150	125	175
		260 - 320	SC	80	120	105	140
N	Cast Aluminum	30	HSS	520	750	650	-
		180	HSS	260	400	350	-
	Wrought Aluminum	30	HSS	520	750	650	850
		180	HSS	260	400	350	450
	Aluminum Bronze	100 - 200	SC	130	190	175	230
		200 - 250	SC	95	150	125	165
Brass	100	HSS	150	220	190	250	
Copper	60	SC	115	150	130	170	

❖ Contact our Application Engineering department for assistance when machining these materials

IMPORTANT: The speeds and feeds listed above are a general starting point for all applications. Refer to the Coolant Recommendation charts for coolant requirements to run at the recommended speeds and feeds. Factory technical assistance is available through our Application Engineering department. See adjustment examples on the following page.

Feed Rate (IPR) by Diameter					
3/8 - 1/2	33/64 - 11/16	45/64 - 15/16	31/32 - 1-3/8	1-13/32 - 1-7/8	1-29/32 - 2-9/16
0.006	0.009	0.011	0.014	0.016	0.018
0.006	0.009	0.011	0.014	0.016	0.018
0.005	0.009	0.011	0.014	0.015	0.017
0.005 ❖	0.008	0.010	0.013	0.015	0.017
0.005 ❖	0.008	0.010	0.013	0.015	0.016
0.004 ❖	0.007	0.009	0.012	0.014	0.016
0.004 ❖	0.007	0.009	0.012	0.014	0.015
0.005	0.008	0.010	0.013	0.015	0.018
0.004	0.007	0.009	0.012	0.014	0.017
0.004	0.007	0.009	0.012	0.014	0.017
0.004	0.006	0.008	0.010	0.013	0.015
0.005	0.007	0.009	0.012	0.013	0.016
0.004	0.007	0.009	0.012	0.013	0.016
0.004	0.006	0.009	0.012	0.013	0.016
0.004	0.005	0.008	0.010	0.012	0.015
0.003	0.005	0.008	0.010	0.012	0.014
0.004 ❖	0.006	0.008	0.009	0.010	0.012
0.003 ❖	0.006	0.008	0.009	0.010	0.012
0.003 ❖	0.005	0.007	0.008	0.009	0.011
0.005 ❖	0.009	0.010	0.012	0.015	0.017
0.004 ❖	0.008	0.009	0.010	0.013	0.016
0.004 ❖	0.007	0.008	0.009	0.012	0.015
0.004	0.005	0.007	0.009	0.010	0.012
0.004	0.005	0.007	0.009	0.009	0.011
0.003 ❖	0.006	0.007	0.009	0.010	0.012
0.003 ❖	0.005	0.006	0.007	0.008	0.010
0.003 ❖	0.006	0.007	0.009	0.010	0.012
0.003 ❖	0.005	0.006	0.007	0.008	0.010
0.005 ❖	0.007	0.008	0.010	0.012	0.015
0.004 ❖	0.006	0.007	0.009	0.010	0.012
0.005 ❖	0.007	0.008	0.010	0.012	0.014
0.004 ❖	0.006	0.007	0.009	0.010	0.011
0.005 ❖	0.007	0.008	0.010	0.012	0.014
0.004 ❖	0.006	0.007	0.009	0.010	0.011
-	-	-	-	-	-
-	-	-	-	-	-
-	-	-	-	-	-
0.003 ❖	0.005	0.007	0.008	0.011	0.015
0.002 ❖	0.004	0.006	0.007	0.009	0.011
0.007	0.012	0.016	0.020	0.024	0.027
0.006	0.011	0.014	0.018	0.022	0.025
0.006	0.009	0.012	0.016	0.018	0.021
0.005	0.007	0.009	0.012	0.014	0.017
0.004	0.006	0.007	0.009	0.012	0.014
0.007	0.011	0.014	0.017	0.018	0.019
0.007	0.011	0.014	0.016	0.017	0.019
0.007	0.011	0.014	0.017	0.018	0.019
0.007	0.011	0.014	0.016	0.017	0.019
0.005	0.009	0.012	0.016	0.020	0.024
0.004	0.006	0.008	0.010	0.012	0.015
0.006	0.010	0.014	0.017	0.021	0.025
0.002 ❖	0.003	0.006	0.008	0.010	0.014

Deep Hole Drilling Speed and Feed Adjustment

	Holder Length				
	Extended	Long	Long Plus	XL	3XL
Speed	0.90	0.85	0.80	0.80	0.75
Feed	-	0.95	0.90	0.90	0.90

Recommended Speed and Feed Example

If the recommended speed and feed is 200 SFM and 0.008 IPR for a standard length holder, then the speed and feed using a 3XL holder in the same application would be 150 SFM and 0.007 IPR.

$200 \cdot 0.75 = 150 \text{ SFM}$

$0.008 \cdot 0.90 = 0.007 \text{ IPR}$

Formulas

- RPM = (3.82 • SFM) / DIA**

where:

 - RPM = revolutions per minute (rev/min)
 - SFM = speed (ft/min)
 - DIA = diameter of drill (inch)
- IPM = RPM • IPR**

where:

 - IPM = inches per minute (in/min)
 - RPM = revolutions per minute (rev/min)
 - IPR = feed rate (in/rev)
- SFM = RPM • 0.262 • DIA**

where:

 - SFM = speed (ft/min)
 - RPM = revolutions per minute (rev/min)
 - DIA = diameter of drill (inch)





⚠ WARNING Tool failure can cause serious injury. To prevent:

- When using holders without support bushing, use a short T-A® holder to establish an initial hole that is a minimum of 2 diameters deep.
- Do not rotate tool holder more than 50 RPM unless it is engaged with the workpiece or fixture.

Visit www.alliedmachine.com/DeepHoleGuidelines for the most up-to-date information and procedures. Factory technical assistance is available for your specific applications through our Application Engineering Team.





Original T-A Recommended Drilling Data | Imperial (inch)

Carbide Inserts | Flat Bottom Geometry

ISO	Material	Hardness (BHN)	Carbide Grade	SFM				Feed Rate (IPR) by Diameter			
				 TiN	 TiAlN	 TiCN	 AM200®	3/8 - 1/2	33/64 - 11/16	45/64 - 15/16	13/32 - 1-7/8
P	Free Machining Steel 1118, 1215, 12L14, etc.	100 - 150	C2	270	380	325	425	0.007	0.010	0.013	0.015
		150 - 200	C2	240	320	280	375	0.006	0.009	0.012	0.014
		200 - 250	C2	220	300	260	350	0.005	0.009	0.011	0.013
	Low Carbon Steel 1010, 1020, 1025, 1522, 1144, etc.	85 - 125	C2	260	345	315	410	0.007 ❖	0.009	0.011	0.014
		125 - 175	C2	220	300	260	350	0.006 ❖	0.009	0.011	0.014
		175 - 225	C2	200	280	235	320	0.005 ❖	0.008	0.010	0.013
	Medium Carbon Steel 1030, 1040, 1050, 1527, 1140, 1151, etc.	125 - 175	C2	220	300	260	350	0.006	0.009	0.011	0.014
		175 - 225	C2	200	280	240	320	0.005	0.008	0.010	0.013
		225 - 275	C2	180	240	215	285	0.004 ❖	0.008	0.010	0.013
	Alloy Steel 4140, 5140, 8640, etc.	275 - 325	C2	150	210	180	240	0.004	0.007	0.009	0.012
		125 - 175	C2	215	290	250	340	0.006	0.009	0.011	0.014
		175 - 225	C2	200	270	230	320	0.005	0.008	0.010	0.013
225 - 275		C2	180	230	205	290	0.005	0.008	0.010	0.013	
275 - 325		C2	175	215	190	280	0.004	0.007	0.009	0.012	
High Strength Alloy 4340, 4330V, 300M, etc.	325 - 375	C2	145	190	170	230	0.003	0.006	0.009	0.011	
	225 - 300	C2	140	170	160	220	0.005 ❖	0.008	0.009	0.010	
	300 - 350	C2	120	160	140	190	0.004 ❖	0.007	0.008	0.009	
Structural Steel A36, A285, A516, etc.	350 - 400	C2	100	145	120	160	0.003 ❖	0.006	0.007	0.009	
	100 - 150	C2	205	265	240	325	0.007 ❖	0.009	0.012	0.014	
	150 - 250	C2	170	215	200	270	0.005 ❖	0.009	0.010	0.012	
Tool Steel H-13, H-21, A-4, O-2, S-3, etc.	250 - 350	C2	155	200	180	240	0.004 ❖	0.008	0.009	0.010	
	150 - 200	C2	140	190	160	220	0.003	0.006	0.008	0.009	
	200 - 250	C2	100	150	120	160	0.003	0.006	0.008	0.009	
	S	High Temp Alloy Hastelloy B, Inconel 600, etc.	140 - 220	C2	70	90	80	110	0.003 ❖	0.006	0.008
220 - 310			C2	50	70	60	80	0.003 ❖	0.005	0.007	0.009
Titanium Alloy		140 - 220	C2	85	110	90	130	0.003 ❖	0.005	0.006	0.008
		220 - 310	C2	70	95	80	100	0.003 ❖	0.004	0.005	0.007
Aerospace Alloy S82		185 - 275	C2	140	120	165	130	0.006 ❖	0.006	0.010	0.012
	275 - 350	C2	110	90	125	105	0.005 ❖	0.005	0.009	0.010	
M	Stainless Steel 400 Series 416, 420, etc.	185 - 275	C2	140	180	165	210	0.006 ❖	0.008	0.010	0.012
		275 - 350	C2	110	140	125	160	0.005 ❖	0.007	0.009	0.010
	Stainless Steel 300 Series 304, 316, 17-4PH, etc.	135 - 185	C2	90	120	110	130	0.005 ❖	0.007	0.008	0.010
		185 - 275	C2	70	90	80	105	0.004 ❖	0.006	0.007	0.009
	Super Duplex Stainless Steel	135 - 185	C2	70	95	85	110	0.004 ❖	0.006	0.007	0.008
185 - 275		C2	55	70	60	85	0.003 ❖	0.005	0.006	0.007	

❖ Contact our Application Engineering department for assistance when machining these materials

IMPORTANT: The speeds and feeds listed above are a general starting point for all applications. Refer to the Coolant Recommendation charts for coolant requirements to run at the recommended speeds and feeds. Factory technical assistance is available through our Application Engineering department. See adjustment examples on the following page.

ISO	Material	Hardness (BHN)	Carbide Grade	SFM				Feed Rate (IPR) by Diameter			
				 TiN	 TiAlN	 TiCN	 AM200®	3/8 - 1/2	33/64 - 11/16	45/64 - 15/16	13/32 - 1-7/8
H	Wear Plate Hardox, AR400, T-1, etc.	400	C2	65	100	85	130	0.003 ❖	0.004	0.006	0.008
		500	C2	45	75	60	100	0.002 ❖	0.003	0.005	0.006
		600	C2	35	65	45	80	0.001 ❖	0.002	0.004	0.005
	Hardened Steel	300 - 400	C2	100	125	110	135	0.004 ❖	0.006	0.007	0.009
400 - 500		C2	60	75	65	110	0.003 ❖	0.005	0.06	0.007	
K	Nodular, Grey, Ductile Cast Iron	120 - 150	C2	270	405	360	450	0.007	0.010	0.013	0.016
		150 - 200	C2	230	350	290	390	0.006	0.009	0.011	0.014
		200 - 220	C2	200	320	260	350	0.005	0.008	0.010	0.013
		220 - 260	C2	180	270	220	300	0.004	0.007	0.009	0.011
		260 - 320	C2	160	240	200	265	0.004	0.006	0.009	0.009
N	Cast Aluminum	30	C2	520	750	650	-	0.009	0.013	0.016	0.017
		180	C2	260	400	350	-	0.008	0.012	0.014	0.015
	Wrought Aluminum	30	C2	950	1200	1070	1270	0.005	0.007	0.009	0.010
		180	C2	630	800	715	850	0.004	0.006	0.008	0.009
	Aluminum Bronze	100 - 200	C2	240	310	280	340	0.004	0.006	0.008	0.011
		200 - 250	C2	180	265	220	285	0.003	0.005	0.006	0.008
	Brass	100	C2	370	520	450	600	0.005	0.006	0.008	0.012
Copper	60	C2	220	345	280	380	0.002 ❖	0.002	0.003	0.005	

❖ Contact our our Application Engineering department for assistance when machining these materials

Deep Hole Drilling Speed and Feed Adjustment

	⚠ Holder Length				
	Extended	Long	Long Plus	XL	3XL
Speed	0.90	0.85	0.80	0.80	0.75
Feed	-	0.95	0.90	0.90	0.90

Recommended Speed and Feed Example

If the recommended speed and feed is 200 SFM and 0.008 IPR for a standard length holder, then the speed and feed using a 3XL holder in the same application would be 150 SFM and 0.007 IPR.

$200 \cdot 0.75 = 150 \text{ SFM}$	$0.008 \cdot 0.90 = 0.007 \text{ IPR}$
------------------------------------	--

Formulas

1. $RPM = (3.82 \cdot SFM) / DIA$ where: RPM = revolutions per minute (rev/min) SFM = speed (ft/min) DIA = diameter of drill (inch)	2. $IPM = RPM \cdot IPR$ where: IPM = inches per minute (in/min) RPM = revolutions per minute (rev/min) IPR = feed rate (in/rev)	3. $SFM = RPM \cdot 0.262 \cdot DIA$ where: SFM = speed (ft/min) RPM = revolutions per minute (rev/min) DIA = diameter of drill (inch)
---	--	--

⚠ WARNING Tool failure can cause serious injury. To prevent:

- When using holders without support bushing, use a short T-A® holder to establish an initial hole that is a minimum of 2 diameters deep.
- Do not rotate tool holder more than 50 RPM unless it is engaged with the workpiece or fixture.

Visit www.alliedmachine.com/DeepHoleGuidelines for the most up-to-date information and procedures. Factory technical assistance is available for your specific applications through our Application Engineering Team.

A DRILLING
B BORING
C REAMING
D BURNISHING
E THREADING
X SPECIALS

Original T-A Recommended Drilling Data | Imperial (inch)

Carbide Inserts | Diamond Coating

Material	Carbide Grade	SFM  Diamond Coating	Feed Rate (IPR) by Diameter				
			3/8 - 1/2	33/64 - 11/16	45/64 - 15/16	31/32 - 1-3/8	
Polymer Matrix Composites	Carbon (hard)	N2	1000 - 1500	0.004 - 0.006	0.008 - 0.010	0.010 - 0.012	0.012 - 0.014
	Carbon Fiber	N2	1000 - 1500	0.004 - 0.006	0.008 - 0.010	0.010 - 0.012	0.012 - 0.014
	Carbon / Glass Fiber	N2	1000 - 1500	0.004 - 0.006	0.008 - 0.010	0.010 - 0.012	0.012 - 0.014
	Fiberglass	N2	1000 - 1500	0.004 - 0.006	0.008 - 0.010	0.010 - 0.012	0.012 - 0.014
	Graphite	N2	1000 - 1500	0.004 - 0.006	0.008 - 0.010	0.010 - 0.012	0.012 - 0.014
	Plastics	N2	250 - 1000	0.004 - 0.006	0.008 - 0.010	0.010 - 0.012	0.012 - 0.014
	Epoxy Resin	N2	250 - 1000	0.004 - 0.006	0.008 - 0.010	0.010 - 0.012	0.012 - 0.014
	Bismaleimide Resin	N2	250 - 1000	0.004 - 0.006	0.008 - 0.010	0.010 - 0.012	0.012 - 0.014
	Polyester Resin	N2	250 - 1000	0.004 - 0.006	0.008 - 0.010	0.010 - 0.012	0.012 - 0.014
	Phenolic Resin	N2	250 - 1000	0.004 - 0.006	0.008 - 0.010	0.010 - 0.012	0.012 - 0.014
Rubber	N2	250 - 1000	0.004 - 0.006	0.008 - 0.010	0.010 - 0.012	0.012 - 0.014	
Metal Matrix Composites	Aluminum	N2	1000	0.008	0.013	0.016	0.020
	Si < 10%	N2	1000	0.008	0.013	0.016	0.020
	10% < Si < 15%	N2	850 - 1000	0.008	0.013	0.016	0.020
	15% < Si < 20%	N2	650 - 850	0.008	0.013	0.016	0.020
	20% < Si < 25%	N2	500 - 650	0.008	0.013	0.016	0.020
	25% < Si	N2	200 - 500	0.008	0.013	0.016	0.020
	Brass	N2	250 - 500	0.008	0.013	0.016	0.020
	Bronze	N2	250 - 500	0.008	0.013	0.016	0.020
	Copper	N2	100 - 250	0.004 - 0.006	0.008 - 0.010	0.010 - 0.012	0.012 - 0.014
	Copper Alloys	N2	100 - 250	0.004 - 0.006	0.008 - 0.010	0.010 - 0.012	0.012 - 0.014
	Lead Alloys	N2	100 - 250	0.004 - 0.006	0.008 - 0.010	0.010 - 0.012	0.012 - 0.014
	Magnesium Alloys	N2	100 - 250	0.004 - 0.006	0.008 - 0.010	0.010 - 0.012	0.012 - 0.014
Precious Metals	N2	100 - 250	0.004 - 0.006	0.008 - 0.010	0.010 - 0.012	0.012 - 0.014	
Ceramic Matrix Composites	Carbide (green)	N2	50 - 250	0.004 - 0.006	0.008 - 0.010	0.010 - 0.012	0.012 - 0.014
	Ceramic (green)	N2	50 - 250	0.004 - 0.006	0.008 - 0.010	0.010 - 0.012	0.012 - 0.014
	Ceramic (pre-sintered)	N2	50 - 250	0.004 - 0.006	0.008 - 0.010	0.010 - 0.012	0.012 - 0.014

Deep Hole Drilling Speed and Feed Adjustment

	Holder Length				
	Extended	Long	Long Plus	XL	3XL
Speed	0.90	0.85	0.80	0.80	0.75
Feed	-	0.95	0.90	0.90	0.90

Recommended Speed and Feed Example

If the recommended speed and feed is 200 SFM and 0.008 IPR for a standard length holder, then the speed and feed using a 3XL holder in the same application would be 150 SFM and 0.007 IPR.

$200 \cdot 0.75 = 150 \text{ SFM}$	$0.008 \cdot 0.90 = 0.007 \text{ IPR}$
------------------------------------	--

⚠ WARNING Tool failure can cause serious injury. To prevent:

- When using holders without support bushing, use a short T-A® holder to establish an initial hole that is a minimum of 2 diameters deep.
- Do not rotate tool holder more than 50 RPM unless it is engaged with the workpiece or fixture.

Visit www.alliedmachine.com/DeepHoleGuidelines for the most up-to-date information and procedures. Factory technical assistance is available for your specific applications through our Application Engineering Team.

IMPORTANT: The speeds and feeds listed above are a general starting point for all applications. Refer to the Coolant Recommendation charts for coolant requirements to run at the recommended speeds and feeds. Factory technical assistance is available through our Application Engineering department. See adjustment examples on the following page.

Tap Drill Information and Formulas | Imperial (inch)

American - Unified Inch Screw Thread

Tap Size	Tap Drill Size	Decimal Equivalent	* Theo % Thread	Probable Mean Oversize	Probable Hole Size	** Probable % Thread
7/16 - 20	W	0.3860	79%	0.003"	0.3890"	75%
7/16 - 20	25/64"	0.3906	72%	0.003"	0.3936"	68%
1/2 - 13	10.5mm	0.4134	87%	0.003"	0.4164"	84%
1/2 - 13	27/64"	0.4219	78%	0.003"	0.4249"	75%
1/2 - 13	7/16"	0.4375	63%	0.003"	0.4405"	60%
1/2 - 20	29/64"	0.4531	72%	0.003"	0.4561"	68%
9/16 - 12	15/32"	0.4688	87%	0.003"	0.4718"	84%
9/16 - 12	12.0mm	0.4724	72%	0.003"	0.4874"	69%
9/16 - 12	31/64"	0.4844	83%	0.003"	0.4754"	80%
9/16 - 18	1/2"	0.5000"	87%	0.003"	0.5030"	82%
9/16 - 18	13.0mm	0.5118"	70%	0.003"	0.5148"	66%
9/16 - 18	31/64"	0.5156"	65%	0.003"	0.5186"	61%
5/8 - 11	17/32"	0.5313"	79%	0.003"	0.5343"	77%
5/8 - 12	35/64"	0.5469"	72%	0.003"	0.5499"	69%
5/8 - 18	9/16"	0.5625"	87%	0.003"	0.5655"	82%
5/8 - 18	14.5mm	0.5709"	75%	0.003"	0.5739"	75%
5/8 - 18	37/64"	0.5781"	65%	0.003"	0.5811"	70%
11/16 - 12	39/64"	0.6094"	72%	0.003"	0.6124"	69%
3/4 - 10	41/64"	0.6406"	84%	0.003"	0.6436"	82%
3/4 - 10	16.5mm	0.6496"	77%	0.003"	0.6526"	75%
3/4 - 10	21/32"	0.6563"	72%	0.003"	0.6593"	70%
3/4 - 12	43/64"	0.6719"	72%	0.003"	0.6749"	69%
3/4 - 16	11/16"	0.6875"	77%	0.003"	0.6905"	73%
3/4 - 16	17.5mm	0.6890"	75%	0.003"	0.6920"	71%
7/8 - 9	49/64"	0.7656"	76%	0.003"	0.7686"	74%
7/8 - 9	25/32"	0.7813"	65%	0.003"	0.7843"	63%
7/8 - 14	51/64"	0.7969"	84%	0.003"	0.7999"	81%
7/8 - 14	13/16"	0.8125"	67%	0.003"	0.8155"	64%
15/16 - 12	55/64"	0.8594"	72%	0.003"	0.8624"	69%
15/16 - 20	57/64"	0.8906"	72%	0.003"	0.8936"	68%
1 - 8	22.0mm	0.8661"	82%	0.003"	0.8691"	81%
1 - 8	7/8"	0.8750"	77%	0.003"	0.8780"	75%
1 - 8	57/64"	0.8906"	67%	0.003"	0.8936"	65%
1 - 12	29/32"	0.9063"	87%	0.003"	0.9093"	84%
1 - 12	59/64"	0.9219"	72%	0.003"	0.9249"	69%
1 - 14	15/16"	0.9375"	67%	0.003"	0.9405"	64%
1-1/8 - 12	1-1/32"	1.0313"	87%	0.003"	1.0343"	84%
1-1/8 - 12	1-3/64"	1.0469"	72%	0.003"	1.0499"	69%
1-1/4 - 7	1-7/64"	1.1094"	76%	0.003"	1.1124"	74%
24 x 2	7/8"	0.8750"	68%	0.075mm	22.30mm	65%
27 x 3	24.0mm	0.9449"	77%	0.075mm	24.08mm	75%

Taper Pipe Thread (NPT)

Tap Size	Tap Drill Size	Decimal Equivalent	Theo % Thread*	Probable Mean Oversize	Probable Hole Size	Probable % Thread**
1/4 - 18	7/16	0.4375	-	0.003	0.4405	-
3/8 - 18	9/16	0.5625	-	0.003	0.5655	-
1/2 - 14	45/64	0.7031	-	0.003	0.7061	-
3/4 - 14	29/32	0.9063	-	0.003	0.9093	-

* Based on nominal tap drill diameter

** Based on .003" probable mean oversize

To calculate the percent of full thread for a given hole diameter:

$$\% \text{ Thread} = \# \text{ of Thread per Inch} \left[\frac{\text{Basic Major Diameter of Thread} - \text{Drill Hole Size}}{0.0130} \right]$$

Notes

- The above tap drill information represents probable thread percentages for the standard tap drills stocked at Allied Machine. Special insert diameters may be required in order to meet a user specific percentage of thread requirements.
- The .003 probable mean oversize hole condition is based on optimum cutting conditions. Probable percent of full thread may vary based on less ideal cutting conditions.
- The table and equations on this page are found in the *Machinery's Handbook*. Permission to simplify and print the equations is granted by the Editor of the *Machinery's Handbook*.

Formulas

1.	RPM	= (3.82 • SFM) / DIA
	where:	
	RPM	= revolutions per minute (rev/min)
	SFM	= speed (ft/min)
	DIA	= diameter of drill (inch)
2.	IPM	= RPM • IPR
	where:	
	IPM	= inches per minute (in/min)
	RPM	= revolutions per minute (rev/min)
	IPR	= feed rate (in/rev)
3.	SFM	= RPM • 0.262 • DIA
	where:	
	SFM	= speed (ft/min)
	RPM	= revolutions per minute (rev/min)
	DIA	= diameter of drill (inch)
4.	Thrust	= 153,700 • IPR • DIA • K _m
	where:	
	Thrust	= axial thrust (lbs)
	IPR	= feed rate (in/rev)
	DIA	= diameter of drill (inch)
	K _m	= specific cutting energy (lbs/in ²)
5.	Tool Power	= .6283 • IPR • RPM • K _m • DIA ²
	where:	
	Tool Power	= tool power (HP)
	IPR	= feed rate (in/rev)
	RPM	= revolutions per minute (rev/min)
	K _m	= specific cutting energy (lbs/in ²)
	DIA	= diameter of drill (inch)

Material Constants

Type of Material	Hardness	K _m (lbs/in ²)
Plain Carbon and Alloy Steel	85 - 200 BHN	0.79
	200 - 275 BHN	0.94
	275 - 375 BHN	1.00
	375 - 425 BHN	1.15
High Temperature Alloys	-	1.44
Stainless Steels	135 - 275 BHN	0.94
	30 - 45 RC	1.08
Cast Iron	100 - 200 BHN	0.50
	200 - 300 BHN	1.08
Copper Alloy	20 - 80 RB	0.43
	80 - 100 RB	0.72
Titanium Alloy	-	0.72
Aluminum Alloy	-	0.22
Magnesium Alloy	-	0.16

Coolant Recommendations | Imperial (inch)

HSS Drill Inserts

ISO	Material	Pressure or Flow Rate	3/8 - 1/2	33/64 - 11/16	23/32 - 1	1 - 1-1/4	1-1/4 - 2	2 - 3	3 - 4
P	Free Machining Steel 1118, 1215, 12L14, etc.	PSI	175 - 185	100 - 120	105 - 140	80 - 115	75 - 100	40 - 50	65 - 90
		GPM	2.5 - 2.6	2.8 - 3.0	4.4 - 5.2	7 - 8	12 - 14	30 - 33	38 - 44
	Low Carbon Steel 1010, 1020, 1025, 1522, 1144, etc.	PSI	165 - 170	75 - 90	75 - 95	60 - 80	55 - 75	30 - 40	50 - 65
		GPM	2.4 - 2.5	2.4 - 2.6	3.7 - 4.2	6 - 7	11 - 12	26 - 30	33 - 38
	Medium Carbon Steel 1030, 1040, 1050, 1527, 1140, 1151, etc.	PSI	160 - 165	70 - 85	70 - 90	55 - 75	50 - 70	30 - 40	50 - 65
		GPM	2.3 - 2.4	2.3 - 2.6	3.7 - 4.2	5 - 6	10 - 12	26 - 30	33 - 38
	Alloy Steel 4140, 5140, 8640, etc.	PSI	160 - 165	65 - 75	65 - 80	50 - 70	45 - 60	30 - 35	40 - 50
		GPM	2.3 - 2.4	2.2 - 2.4	3.5 - 3.9	5 - 6	10 - 11	26 - 28	30 - 33
	High Strength Alloy 4340, 4330V, 300M, etc.	PSI	150 - 155	55 - 60	45 - 50	25 - 30	25 - 30	20 - 25	40 - 50
		GPM	2.3 - 2.4	2.1 - 2.2	2.9 - 3.1	4 - 5	7 - 8	21 - 23	23 - 26
	Structural Steel A36, A285, A516, etc.	PSI	160 - 165	75 - 85	65 - 80	40 - 55	40 - 50	25 - 30	40 - 50
		GPM	2.3 - 2.4	2.4 - 2.6	3.5 - 3.9	5 - 6	9 - 10	23 - 26	30 - 33
Tool Steel H-13, H-21, A-4, O-2, S-3, etc.	PSI	150 - 155	55 - 60	45 - 50	25 - 30	25 - 30	20 - 25	25 - 30	
	GPM	2.3 - 2.4	2.1 - 2.2	2.9 - 3.1	4 - 5	7 - 8	21 - 23	23 - 26	
S	High Temp Alloy Hastelloy B, Inconel 600, etc.	PSI	150 - 155	60 - 65	50 - 55	30 - 35	25 - 30	25 - 30	44
		GPM	2.3 - 2.4	2.2 - 2.3	3.1 - 3.2	4 - 5	7 - 8	23 - 26	33
	Titanium Alloy	PSI	150 - 155	60 - 65	50 - 55	30 - 35	25 - 30	25 - 30	44
		GPM	2.3 - 2.4	2.2 - 2.3	3.1 - 3.2	4 - 5	7 - 8	23 - 26	33
Aerospace Alloy S82	PSI	150 - 155	60 - 65	50 - 55	30 - 35	25 - 30	25 - 30	44	
	GPM	2.3 - 2.4	2.2 - 2.3	3.1 - 3.2	4 - 5	7 - 8	23 - 26	33	
M	Stainless Steel 400 Series 416, 420, etc.	PSI	171	86	75	55	51	29	45
		GPM	3	3	4	6	10	26	31
	Stainless Steel 300 Series 304, 316, 17-4PH, etc.	PSI	171	86	75	55	51	29	45
		GPM	3	3	4	6	10	26	31
	Super Duplex Stainless Steel	PSI	171	86	75	55	51	29	45
		GPM	3	3	4	6	10	26	31
H	Wear Plate Hardox, AR400, T-1, etc.	PSI	155	61	51	29	29	25	29
		GPM	2	2	3	5	8	23	26
	Hardened Steel	PSI	155	61	51	29	29	25	29
		GPM	2	2	3	5	8	23	26
K	SG / Nodular Cast Iron	PSI	160	65	61	41	35	29	35
		GPM	2	2	3	5	9	26	28
	Grey / White Iron	PSI	160	65	61	41	35	29	35
		GPM	2	2	3	5	9	26	28
N	Cast Aluminum	PSI	210	180	230	159	125	51	80
		GPM	3	4	6	9	16	33	42
	Wrought Aluminum	PSI	210	180	230	159	125	51	80
		GPM	3	4	6	9	16	33	42
	Aluminum Bronze	PSI	186	120	140	115	100	51	90
		GPM	2.5	3	5	8	14	33	44
	Brass	PSI	159	65	61	41	35	29	35
		GPM	2	2	3	5	9	26	28
	Copper	PSI	186	120	140	115	100	51	90
		GPM	2.5	3	5	8	14	33	44

Deep Hole Drilling Coolant Adjustment

	Holder Length				
	Extended	Long	Long Plus	XL	3XL
Pressure and Flow	1.3	1.5	2	2	3

Recommended Coolant Example

If the recommended pressure and flow is 150 PSI and 2.4 GPM for a standard length holder, then the adjusted pressure and flow for a 3XL holder would be 450 PSI and 7.2 GPM.

$$150 \cdot 3 = 450 \text{ PSI} \qquad 2.4 \cdot 3 = 7.2 \text{ GPM}$$

⚠️ WARNING Tool failure can cause serious injury. To prevent:

- When using holders without support bushing, use a short T-A® holder to establish an initial hole that is a minimum of 2 diameters deep.
- Do not rotate tool holder more than 50 RPM unless it is engaged with the workpiece or fixture.

Visit www.alliedmachine.com/DeepHoleGuidelines for the most up-to-date information and procedures. Factory technical assistance is available for your specific applications through our Application Engineering Team.

IMPORTANT: The coolant pressure and flow rate recommendations above represent a good approximation to obtain optimum tool life and chip evacuation at Allied Machine recommended speeds and feeds. If lower coolant capabilities exist in a drilling application, the T-A® drilling system will still function at reduced penetration rates. Contact our Application Engineering department for a more specific recommendation of coolant requirements and/or speeds and feeds.

Coolant Recommendations | Imperial (inch)

Carbide Drill Inserts

ISO	Material	Pressure or Flow Rate	3/8 - 1/2	33/64 - 11/16	23/32 - 1	1 - 1-3/8	1-13/32 - 1-7/8
P	Free Machining Steel 1118, 1215, 12L14, etc.	PSI	195	140	160	140	155
		GPM	2.6	3.3	5.5	9	18
	Low Carbon Steel 1010, 1020, 1025, 1522, 1144, etc.	PSI	180	105	105	110	115
		GPM	2.5	2.9	4.4	8	15
	Medium Carbon Steel 1030, 1040, 1050, 1527, 1140, 1151, etc.	PSI	175	100	90	70	75
		GPM	2.5	2.8	4.1	7	13
	Alloy Steel 4140, 5140, 8640, etc.	PSI	165	85	100	75	70
		GPM	2.4	2.6	4.3	6	12
	High Strength Alloy 4340, 4330V, 300M, etc.	PSI	175	115	105	75	70
		GPM	2.4	2.3	3.2	5	8
Structural Steel A36, A285, A516, etc.	PSI	175	115	105	75	70	
	GPM	2.5	3.0	4.4	6	12	
Tool Steel H-13, H-21, A-4, O-2, S-3, etc.	PSI	155	60	55	40	35	
	GPM	2.4	2.2	3.2	5	8	
S	High Temp Alloy Hastelloy B, Inconel 600, etc.	PSI	247	160	174	160	130
		GPM	3	4	6	9	16
	Titanium Alloy	PSI	247	160	174	160	130
		GPM	3	4	6	9	16
	Aerospace Alloy S82	PSI	247	160	174	160	130
		GPM	3	4	6	9	16
M	Stainless Steel 400 Series 416, 420, etc.	PSI	329	239	260	250	190
		GPM	3	4	7	12	20
	Stainless Steel 300 Series 304, 316, 17-4PH, etc.	PSI	329	239	260	250	190
		GPM	3	4	7	12	20
	Super Duplex Stainless Steel	PSI	329	239	260	250	190
		GPM	3	4	7	12	20
H	Wear Plate Hardox, AR400, T-1, etc.	PSI	210	75	70	49	45
		GPM	3	2	4	5	10
	Hardened Steel	PSI	210	75	70	49	45
		GPM	3	2	4	5	10
K	SG / Nodular Cast Iron	PSI	225	104	90	90	80
		GPM	3	3	4	7	13
	Grey / White Iron	PSI	225	104	90	90	80
		GPM	3	3	4	7	13
N	Cast Aluminum	PSI	350	319	315	284	200
		GPM	4	5	8	12	20
	Wrought Aluminum	PSI	350	319	315	284	200
		GPM	4	5	8	12	20
	Aluminum Bronze	PSI	290	239	239	220	174
		GPM	3	4	7	11	19
	Brass	PSI	350	319	315	284	200
		GPM	4	5	7	12	20
	Copper	PSI	290	239	239	220	174
		GPM	3	4	7	11	19

Deep Hole Drilling Coolant Adjustment

	Holder Length				
	Extended	Long	Long Plus	XL	3XL
Pressure and Flow	1.3	1.5	2	2	3

Recommended Coolant Example

If the recommended pressure and flow is 150 PSI and 2.4 GPM for a standard length holder, then the adjusted pressure and flow for a 3XL holder would be 450 PSI and 7.2 GPM.

$$150 \cdot 3 = 450 \text{ PSI}$$

$$2.4 \cdot 3 = 7.2 \text{ GPM}$$

⚠️ WARNING Tool failure can cause serious injury. To prevent:

- When using holders without support bushing, use a short T-A® holder to establish an initial hole that is a minimum of 2 diameters deep.
- Do not rotate tool holder more than 50 RPM unless it is engaged with the workpiece or fixture.

Visit www.alliedmachine.com/DeepHoleGuidelines for the most up-to-date information and procedures. Factory technical assistance is available for your specific applications through our Application Engineering Team.

IMPORTANT: The coolant pressure and flow rate recommendations above represent a good approximation to obtain optimum tool life and chip evacuation at Allied Machine recommended speeds and feeds. If lower coolant capabilities exist in a drilling application, the T-A® drilling system will still function at reduced penetration rates. Contact our Application Engineering department for a more specific recommendation of coolant requirements and/or speeds and feeds.

GEN2 T-A Recommended Drilling Data | Metric (mm)

HSS Inserts

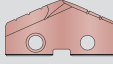
ISO	Material	Hardness (BHN)	HSS Grade	M/min		Feed Rate (mm/rev) by Diameter	
				 TiN	 AM200®	9.50 - 12.95	12.98 - 17.52
P	Free Machining Steel 1118, 1215, 12L14, etc.	100 - 150	HSS	61	99	0.20	0.30
		150 - 200	HSS	55	91	0.18	0.28
		200 - 250	HSS	49	85	0.15	0.25
	Low Carbon Steel 1010, 1020, 1025, 1522, 1144, etc.	85 - 125	HSS	52	88	0.20 ❖	0.25
		125 - 175	HSS	49	83	0.18 ❖	0.25
		175 - 225	HSS	46	79	0.15 ❖	0.23
	Medium Carbon Steel 1030, 1040, 1050, 1527, 1140, 1151, etc.	225 - 275	HSS	43	73	0.13 ❖	0.23
		125 - 175	HSS	49	83	0.18	0.25
		175 - 225	HSS	46	79	0.15	0.23
	Alloy Steel 4140, 5140, 8640, etc.	225 - 275	HSS	43	73	0.15	0.23
		275 - 325	SC, PC	40	68	0.13	0.20
		325 - 375	SC, PC	34	54	0.10	0.18
275 - 325		SC, PC	37	59	0.13	0.20	
High Strength Alloy 4340, 4330V, 300M, etc.	350 - 400	PC	15	24	0.10 ❖	0.18	
	225 - 300	SC, PC	24	38	0.15 ❖	0.23	
	300 - 350	SC, PC	18	30	0.13 ❖	0.20	
Structural Steel A36, A285, A516, etc.	250 - 350	SC, PC	30	48	0.13 ❖	0.23	
	100 - 150	HSS	43	71	0.20 ❖	0.28	
	150 - 250	HSS	37	57	0.15 ❖	0.25	
Tool Steel H-13, H-21, A-4, O-2, S-3, etc.	200 - 250	SC, PC	18	32	0.10	0.18	
	150 - 200	SC	24	38	0.10	0.18	
S	High Temp Alloy Hastelloy B, Inconel 600, etc.	140 - 220	SC, PC	9	13	0.10 ❖	0.18
		220 - 310	PC	8	12	0.10 ❖	0.15
	Titanium Alloy	140 - 220	SC, PC	11	16	0.10 ❖	0.18
		220 - 310	PC	10	15	0.08 ❖	0.15
Aerospace Alloy S82	185 - 275	SC, PC	23	35	0.15 ❖	0.20	
	275 - 350	SC, PC	18	31	0.13 ❖	0.18	
M	Stainless Steel 400 Series 416, 420, etc.	185 - 275	SC, PC	23	35	0.15 ❖	0.20
		275 - 350	SC, PC	18	31	0.13 ❖	0.18
	Stainless Steel 300 Series 304, 316, 17-4PH, etc.	135 - 185	SC, PC	23	35	0.08 ❖	0.18
		185 - 275	SC, PC	18	31	0.08 ❖	0.15
	Super Duplex Stainless Steel	135 - 185	SC, PC	18	26	0.08 ❖	0.18
185 - 275		SC, PC	15	22	0.08 ❖	0.15	
H	Wear Plate Hardox, AR400, T-1, etc.	400	SC, PC	14	21	0.08 ❖	0.15
		500	PC	10	14	0.05 ❖	0.12
		600	N/A	-	-	-	-
	Hardened Steel	300 - 400	PC	15	29	0.10 ❖	0.15
400 - 500		PC	10	14	0.06 ❖	0.12	
K	Nodular, Grey, Ductile Cast Iron	120 - 150	HSS	52	84	0.20	0.30
		150 - 200	HSS	46	79	0.18	0.28
		200 - 220	HSS	40	68	0.15	0.23
		220 - 260	SC, PC	34	57	0.13	0.20
		260 - 320	SC, PC	27	47	0.13	0.18
N	Cast Aluminum	30	HSS	183	-	0.23	0.38
		180	HSS	91	-	0.20	0.33
	Wrought Aluminum	30	HSS	183	280	0.12	0.33
		180	HSS	91	200	0.12	0.18
	Aluminum Bronze	100 - 200	SC	52	82	0.15	0.24
		200 - 250	SC	40	65	0.12	0.18
	Brass	100	HSS	91	144	0.18	0.27
Copper	60	SC	40	58	0.07 ❖	0.10	

❖ Contact our Application Engineering department for assistance when machining these materials

IMPORTANT: The speeds and feeds listed above are a general starting point for all applications. Refer to the Coolant Recommendation charts for coolant requirements to run at the recommended speeds and feeds. Factory technical assistance is available through our Application Engineering department. See adjustment examples on the following page.

Feed Rate (mm/rev) by Diameter				
17.53 - 24.38	24.41 - 35.00	35.01 - 47.80	47.85 - 65.99	66.00 - 114.48
0.41	0.48	0.51	0.58	0.71
0.38	0.43	0.51	0.58	0.71
0.36	0.41	0.51	0.58	0.71
0.36	0.46	0.48	0.58	0.69
0.36	0.43	0.48	0.58	0.69
0.33	0.41	0.46	0.53	0.61
0.33	0.41	0.46	0.53	0.61
0.36	0.43	0.48	0.58	0.69
0.33	0.41	0.46	0.53	0.61
0.33	0.41	0.46	0.53	0.61
0.30	0.38	0.41	0.48	0.56
0.36	0.43	0.43	0.48	0.56
0.33	0.41	0.43	0.48	0.56
0.33	0.41	0.43	0.48	0.56
0.30	0.38	0.38	0.43	0.51
0.28	0.36	0.38	0.43	0.51
0.28	0.33	0.36	0.43	0.51
0.25	0.30	0.36	0.43	0.51
0.23	0.28	0.30	0.41	0.46
0.38	0.43	0.46	0.53	0.66
0.33	0.38	0.41	0.48	0.61
0.30	0.33	0.36	0.43	0.51
0.25	0.30	0.30	0.38	0.43
0.25	0.30	0.30	0.38	0.43
0.23	0.28	0.30	0.38	-
0.20	0.25	0.25	0.30	-
0.21	0.27	0.30	0.38	-
0.18	0.23	0.25	0.30	-
0.23	0.28	0.36	0.41	0.51
0.20	0.25	0.30	0.36	0.46
0.23	0.28	0.36	0.41	0.51
0.20	0.25	0.30	0.36	0.46
0.23	0.28	0.36	0.41	0.51
0.20	0.25	0.30	0.36	0.46
0.20	0.23	0.30	0.41	0.46
0.18	0.20	0.25	0.30	0.40
-	-	-	-	-
0.23	0.27	0.30	0.41	0.46
0.18	0.24	0.25	0.30	0.40
0.41	0.51	0.61	0.69	0.76
0.38	0.48	0.56	0.64	0.71
0.33	0.43	0.46	0.53	0.61
0.28	0.36	0.36	0.43	0.51
0.25	0.28	0.28	0.36	0.41
0.46	0.58	0.56	0.64	0.64
0.40	0.50	0.56	0.64	0.64
0.40	0.50	0.56	0.64	0.64
0.30	0.35	0.56	0.64	0.64
0.30	0.38	0.43	0.48	0.53
0.23	0.28	0.36	0.40	0.46
0.33	0.45	0.47	0.53	0.58
0.18	0.26	0.23	0.27	0.31

Deep Hole Drilling Speed and Feed Adjustment

	Holder Length				
	Extended	Long	Long Plus	XL	3XL
Speed	0.90	0.85	0.80	0.80	0.75
Feed	-	0.95	0.90	0.90	0.90

Recommended Speed and Feed Example

If the recommended speed and feed is 50 M/min and 0.20 mm/rev for a standard length holder, then the speed and feed using a 3XL holder in the same application would be 37.5 M/min and 0.18 mm/rev.

$50 \cdot 0.75 = 37.5 \text{ M/min}$ $0.20 \cdot 0.90 = 0.18 \text{ mm/rev}$

Formulas

- RPM = (318.47 • M/min) / DIA**

where:
 RPM = revolutions per minute (rev/min)
 M/min = speed (M/min)
 DIA = diameter of drill (mm)
- mm/min = RPM • mm/rev**

where:
 mm/min = mm per minute (mm/min)
 RPM = revolutions per minute (rev/min)
 mm/rev = feed rate (mm/rev)
- M/min = RPM • 0.003 • DIA**

where:
 M/min = speed (M/min)
 RPM = revolutions per minute (rev/min)
 DIA = diameter of drill (mm)

⚠ WARNING Tool failure can cause serious injury. To prevent:

- When using holders without support bushing, use a short T-A® holder to establish an initial hole that is a minimum of 2 diameters deep.
- Do not rotate tool holder more than 50 RPM unless it is engaged with the workpiece or fixture.

Visit www.alliedmachine.com/DeepHoleGuidelines for the most up-to-date information and procedures. Factory technical assistance is available for your specific applications through our Application Engineering Team.

GEN2 T-A Recommended Drilling Data | Metric (mm)

Carbide Inserts

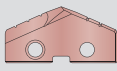
ISO	Material	Hardness (BHN)	HSS Grade	M/min  AM200®	Feed Rate (mm/rev) by Diameter			
					9.50 - 12.95	12.98 - 17.53	17.54 - 24.38	24.41 - 35.00
P	Free Machining Steel 1118, 1215, 12L14, etc.	100 - 150	C1	146	0.20	0.30	0.41	0.48
		150 - 200	C1	126	0.18	0.28	0.38	0.43
		200 - 250	C1	119	0.15	0.25	0.36	0.41
	Low Carbon Steel 1010, 1020, 1025, 1522, 1144, etc.	85 - 125	C1	137	0.20 ❖	0.25	0.36	0.46
		125 - 175	C1	119	0.18 ❖	0.25	0.36	0.43
		175 - 225	C1	108	0.15 ❖	0.23	0.33	0.41
	Medium Carbon Steel 1030, 1040, 1050, 1527, 1140, 1151, etc.	225 - 275	C1	95	0.13 ❖	0.23	0.33	0.41
		125 - 175	C1	119	0.18	0.25	0.36	0.43
		175 - 225	C1	108	0.15	0.23	0.33	0.41
	Alloy Steel 4140, 5140, 8640, etc.	225 - 275	C1	95	0.15	0.23	0.33	0.41
		275 - 325	C1	80	0.13	0.20	0.30	0.38
		125 - 175	C1	115	0.18	0.25	0.36	0.43
175 - 225		C1	105	0.15	0.23	0.33	0.43	
225 - 275		C1	95	0.15	0.23	0.33	0.41	
High Strength Alloy 4340, 4330V, 300M, etc.	275 - 325	C1	87	0.13	0.20	0.30	0.38	
	325 - 375	C1	78	0.10	0.18	0.28	0.36	
	225 - 300	C1	70	0.15 ❖	0.23	0.28	0.33	
Structural Steel A36, A285, A516, etc.	300 - 350	C1	63	0.13 ❖	0.20	0.25	0.30	
	350 - 400	C1	56	0.10 ❖	0.18	0.23	0.28	
	100 - 150	C1	108	0.20 ❖	0.28	0.38	0.43	
Tool Steel H-13, H-21, A-4, O-2, S-3, etc.	150 - 250	C1	87	0.15 ❖	0.25	0.33	0.38	
	250 - 350	C1	80	0.13 ❖	0.23	0.30	0.33	
	150 - 200	C1	78	0.10	0.18	0.25	0.30	
S	High Temp Alloy Hastelloy B, Inconel 600, etc.	200 - 250	C1	59	0.10	0.18	0.25	0.30
		140 - 220	C2	37	0.10 ❖	0.18	0.23	0.28
	220 - 310	C2	29	0.10 ❖	0.15	0.20	0.25	
	Titanium Alloy	140 - 220	C2	42	0.10 ❖	0.18	0.21	0.27
		220 - 310	C2	33	0.08 ❖	0.15	0.18	0.23
Aerospace Alloy S82	185 - 275	C2	73	0.12 ❖	0.16	0.18	0.22	
	275 - 350	C2	56	0.10 ❖	0.14	0.16	0.19	
M	Stainless Steel 400 Series 416, 420, etc.	185 - 275	C2	73	0.18 ❖	0.23	0.30	0.36
		275 - 350	C2	56	0.15 ❖	0.20	0.28	0.30
	Stainless Steel 300 Series 304, 316, 17-4PH, etc.	135 - 185	C2	73	0.14 ❖	0.18	0.24	0.29
		185 - 275	C2	56	0.12 ❖	0.16	0.22	0.24
	Super Duplex Stainless Steel	135 - 185	C2	38	0.12 ❖	0.17	0.22	0.26
185 - 275		C2	30	0.10 ❖	0.15	0.18	0.22	

❖ Contact our Application Engineering department for assistance when machining these materials

IMPORTANT: The speeds and feeds listed above are a general starting point for all applications. Refer to the Coolant Recommendation charts for coolant requirements to run at the recommended speeds and feeds. Factory technical assistance is available through our Application Engineering department. See adjustment examples on the following page.

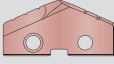
ISO	Material	Hardness (BHN)	HSS Grade	M/min	Feed Rate (mm/rev) by Diameter			
				 AM200®	9.50 - 12.95	12.98 - 17.53	17.54 - 24.38	24.41 - 35.00
H	Wear Plate Hardox, AR400, T-1, etc.	400	C2	45	0.07 ❖	0.12	0.20	0.25
		500	C2	37	0.05 ❖	0.10	0.15	0.20
		600	C2	30	0.04 ❖	0.08	0.12	0.16
	Hardened Steel	300 - 400	C1	47	0.10 ❖	0.18	0.23	0.27
		400 - 500	C1	37	0.06 ❖	0.12	0.18	0.24
K	Nodular, Grey, Ductile Cast Iron	120 - 150	C2	152	0.20	0.30	0.38	0.48
		150 - 200	C2	146	0.18	0.28	0.33	0.43
		200 - 220	C2	131	0.15	0.23	0.30	0.38
		220 - 260	C2	113	0.13	0.20	0.28	0.33
		260 - 320	C2	102	0.13	0.18	0.25	0.28
N	Cast Aluminum	30	C2	300	0.23	0.38	0.46	0.58
		180	C2	225	0.20	0.33	0.40	0.50
	Wrought Aluminum	30	C2	426	0.12	0.33	0.40	0.50
		180	C2	300	0.12	0.18	0.30	0.35
	Aluminum Bronze	100 - 200	C2	110	0.15	0.24	0.30	0.38
		200 - 250	C2	90	0.12	0.18	0.23	0.28
	Brass	100	C2	200	0.18	0.27	0.33	0.45
Copper	60	C2	130	0.07 ❖	0.10	0.18	0.26	

❖ Contact our our Application Engineering department for assistance when machining these materials

Deep Hole Drilling Speed and Feed Adjustment

	⚠ Holder Length				
	Extended	Long	Long Plus	XL	3XL
Speed	0.90	0.85	0.80	0.80	0.75
Feed	-	0.95	0.90	0.90	0.90

Recommended Speed and Feed Example

If the recommended speed and feed is 50 M/min and 0.20 mm/rev for a standard length holder, then the speed and feed using a 3XL holder in the same application would be 37.5 M/min and 0.18 mm/rev.

$50 \cdot 0.75 = 37.5 \text{ M/min}$	$0.20 \cdot 0.90 = 0.18 \text{ mm/rev}$
--------------------------------------	---

Formulas

<p>1. $RPM = (318.47 \cdot M/min) / DIA$</p> <p>where:</p> <ul style="list-style-type: none"> RPM = revolutions per minute (rev/min) M/min = speed (M/min) DIA = diameter of drill (mm) 	<p>2. $mm/min = RPM \cdot mm/rev$</p> <p>where:</p> <ul style="list-style-type: none"> mm/min = mm per minute (mm/min) RPM = revolutions per minute (rev/min) mm/rev = feed rate (mm/rev) 	<p>3. $M/min = RPM \cdot 0.003 \cdot DIA$</p> <p>where:</p> <ul style="list-style-type: none"> M/min = speed (M/min) RPM = revolutions per minute (rev/min) DIA = diameter of drill (mm)
---	---	--

⚠ WARNING Tool failure can cause serious injury. To prevent:



- When using holders without support bushing, use a short T-A® holder to establish an initial hole that is a minimum of 2 diameters deep.
- Do not rotate tool holder more than 50 RPM unless it is engaged with the workpiece or fixture.

Visit www.alliedmachine.com/DeepHoleGuidelines for the most up-to-date information and procedures. Factory technical assistance is available for your specific applications through our Application Engineering Team.

A
DRILLING
B
BORING
C
REAMING
D
BURNISHING
E
THREADING
X
SPECIALS

Original T-A Recommended Drilling Data | Metric (mm)

HSS Inserts

ISO	Material	Hardness (BHN)	HSS Grade	M/min			Feed Rate (mm/rev) by Diameter	
				 TiN	 TiAlN	 TiCN	9.50 - 12.95	12.98 - 17.52
P	Free Machining Steel 1118, 1215, 12L14, etc.	100 - 150	HSS	61	85	79	0.18	0.25
		150 - 200	HSS	55	79	72	0.18	0.25
		200 - 250	HSS	49	73	64	0.15	0.25
	Low Carbon Steel 1010, 1020, 1025, 1522, 1144, etc.	85 - 125	HSS	52	76	67	0.15 ❖	0.23
		125 - 175	HSS	49	73	64	0.15 ❖	0.23
		175 - 225	HSS	46	69	59	0.13 ❖	0.20
	Medium Carbon Steel 1030, 1040, 1050, 1527, 1140, 1151, etc.	225 - 275	HSS	43	64	55	0.13 ❖	0.20
		125 - 175	HSS	49	73	64	0.15	0.23
		175 - 225	HSS	46	69	59	0.13	0.20
	Alloy Steel 4140, 5140, 8640, etc.	225 - 275	HSS	43	64	55	0.13	0.20
		275 - 325	SC, PC	40	59	52	0.10	0.18
		275 - 325	SC, PC	40	59	52	0.10	0.15
325 - 375		SC, PC	34	47	44	0.08	0.15	
High Strength Alloy 4340, 4330V, 300M, etc.	225 - 300	SC, PC	24	34	30	0.13 ❖	0.18	
	300 - 350	SC, PC	18	26	24	0.10 ❖	0.18	
	350 - 400	PC	15	21	20	0.08 ❖	0.15	
Structural Steel A36, A285, A516, etc.	100 - 150	HSS	43	61	55	0.15 ❖	0.25	
	150 - 250	HSS	37	52	47	0.13 ❖	0.23	
	250 - 350	SC, PC	30	43	40	0.10 ❖	0.20	
Tool Steel H-13, H-21, A-4, O-2, S-3, etc.	150 - 200	SC	24	34	32	0.10	0.15	
	200 - 250	SC, PC	18	27	26	0.10	0.15	
S	High Temp Alloy Hastelloy B, Inconel 600, etc.	140 - 220	SC, PC	9	12	11	0.08 ❖	0.18
		220 - 310	PC	8	11	9	0.08 ❖	0.15
	Titanium Alloy	140 - 220	SC, PC	11	15	14	0.08 ❖	0.18
		220 - 310	PC	9	14	11	0.08 ❖	0.15
Aerospace Alloy S82	185 - 275	SC, PC	23	32	29	0.15 ❖	0.20	
	275 - 350	SC, PC	18	27	24	0.13 ❖	0.18	
M	Stainless Steel 400 Series 416, 420, etc.	185 - 275	SC, PC	23	32	29	0.15 ❖	0.20
		275 - 350	SC, PC	18	27	24	0.13 ❖	0.18
	Stainless Steel 300 Series 304, 316, 17-4PH, etc.	135 - 185	SC, PC	23	32	29	0.08 ❖	0.18
		185 - 275	SC, PC	18	27	24	0.08 ❖	0.15
	Super Duplex Stainless Steel	135 - 185	SC, PC	18	24	21	0.08 ❖	0.18
185 - 275		SC, PC	15	20	18	0.08 ❖	0.15	
H	Wear Plate Hardox, AR400, T-1, etc.	400	SC, PC	14	21	17	0.08 ❖	0.15
		500	PC	11	14	12	0.05 ❖	0.13
		600	N/A	-	-	-	-	-
	Hardened Steel	300 - 400	PC	15	29	21	0.08 ❖	0.15
400 - 500		PC	11	14	12	0.05 ❖	0.13	
K	Nodular, Grey, Ductile Cast Iron	120 - 150	HSS	52	76	67	0.18	0.30
		150 - 200	HSS	46	69	59	0.15	0.28
		200 - 220	HSS	40	59	52	0.15	0.23
		220 - 260	SC, PC	34	50	44	0.13	0.18
		260 - 320	SC, PC	27	41	37	0.10	0.15
N	Cast Aluminum	30	HSS	183	259	229	0.20	0.33
		180	HSS	91	137	122	0.20	0.33
	Wrought Aluminum	30	HSS	183	259	229	0.10	0.15
		180	HSS	91	137	122	0.20	0.33
	Aluminum Bronze	100 - 200	SC	52	76	67	0.15	0.28
		200 - 250	SC	40	58	52	0.13	0.18
	Brass	100	HSS	91	136	122	0.18	0.30
Copper	60	SC	40	50	46	0.05 ❖	0.08	

❖ Contact our Application Engineering department for assistance when machining these materials

IMPORTANT: The speeds and feeds listed above are a general starting point for all applications. Refer to the Coolant Recommendation charts for coolant requirements to run at the recommended speeds and feeds. Factory technical assistance is available through our Application Engineering department. See adjustment examples on the following page.

Feed Rate (mm/rev) by Diameter				
17.53 - 24.38	24.41 - 35.00	35.01 - 47.80	47.85 - 65.99	66.00 - 114.48
0.33	0.41	0.51	0.58	0.71
0.33	0.41	0.51	0.58	0.71
0.33	0.41	0.51	0.58	0.71
0.30	0.38	0.48	0.58	0.69
0.30	0.38	0.48	0.58	0.69
0.25	0.36	0.46	0.53	0.61
0.25	0.36	0.46	0.53	0.61
0.30	0.38	0.48	0.58	0.69
0.25	0.36	0.46	0.53	0.61
0.25	0.36	0.46	0.53	0.61
0.23	0.30	0.41	0.48	0.56
0.25	0.36	0.43	0.48	0.56
0.25	0.36	0.43	0.48	0.56
0.25	0.36	0.43	0.48	0.56
0.23	0.30	0.38	0.43	0.51
0.23	0.30	0.38	0.43	0.51
0.23	0.25	0.36	0.43	0.51
0.23	0.25	0.36	0.43	0.51
0.20	0.23	0.30	0.38	0.46
0.30	0.36	0.46	0.53	0.66
0.25	0.30	0.41	0.48	0.61
0.23	0.25	0.36	0.43	0.51
0.20	0.25	0.30	0.38	0.43
0.20	0.25	0.30	0.38	0.43
0.20	0.25	0.30	0.38	0.43
0.20	0.25	0.30	0.38	0.43
0.20	0.25	0.30	0.38	0.43
0.20	0.25	0.30	0.38	0.43
0.20	0.25	0.30	0.38	0.43
0.18	0.20	0.25	0.30	0.36
0.18	0.20	0.25	0.30	0.36
0.18	0.20	0.25	0.30	0.36
0.18	0.20	0.25	0.30	0.36
0.18	0.20	0.25	0.30	0.36
0.18	0.20	0.25	0.30	0.36
0.23	0.25	0.36	0.41	0.51
0.20	0.20	0.30	0.36	0.46
0.20	0.25	0.36	0.41	0.51
0.18	0.20	0.30	0.36	0.46
0.20	0.25	0.36	0.41	0.51
0.18	0.20	0.30	0.36	0.46
0.20	0.23	0.30	0.41	0.46
0.18	0.20	0.25	0.30	0.41
-	-	-	-	-
0.20	0.23	0.30	0.41	0.46
0.18	0.20	0.25	0.30	0.41
0.41	0.51	0.61	0.69	0.76
0.36	0.46	0.56	0.64	0.71
0.30	0.41	0.46	0.53	0.61
0.23	0.30	0.36	0.43	0.51
0.18	0.23	0.30	0.36	0.41
0.41	0.51	0.56	0.64	0.64
0.41	0.46	0.56	0.64	0.64
0.25	0.30	0.56	0.64	0.64
0.41	0.46	0.56	0.64	0.64
0.36	0.46	0.56	0.66	0.71
0.23	0.30	0.36	0.43	0.51
0.41	0.51	0.61	0.71	0.76
0.15	0.20	0.30	0.36	0.41

Deep Hole Drilling Speed and Feed Adjustment

	Holder Length				
	Extended	Long	Long Plus	XL	3XL
Speed	0.90	0.85	0.80	0.80	0.75
Feed	-	0.95	0.90	0.90	0.90

Recommended Speed and Feed Example

If the recommended speed and feed is 50 M/min and 0.20 mm/rev for a standard length holder, then the speed and feed using a 3XL holder in the same application would be 37.5 M/min and 0.18 mm/rev.

$50 \cdot 0.75 = 37.5 \text{ M/min}$	$0.20 \cdot 0.90 = 0.18 \text{ mm/rev}$
--------------------------------------	---

Formulas

1.	RPM	$= (318.47 \cdot \text{M/min}) / \text{DIA}$
	where:	
	RPM	= revolutions per minute (rev/min)
	M/min	= speed (M/min)
	DIA	= diameter of drill (mm)
2.	mm/min	$= \text{RPM} \cdot \text{mm/rev}$
	where:	
	mm/min	= mm per minute (mm/min)
	RPM	= revolutions per minute (rev/min)
	mm/rev	= feed rate (mm/rev)
3.	M/min	$= \text{RPM} \cdot 0.003 \cdot \text{DIA}$
	where:	
	M/min	= speed (M/min)
	RPM	= revolutions per minute (rev/min)
	DIA	= diameter of drill (mm)



⚠ WARNING Tool failure can cause serious injury. To prevent:

- When using holders without support bushing, use a short T-A® holder to establish an initial hole that is a minimum of 2 diameters deep.
- Do not rotate tool holder more than 50 RPM unless it is engaged with the workpiece or fixture.

Visit www.alliedmachine.com/DeepHoleGuidelines for the most up-to-date information and procedures. Factory technical assistance is available for your specific applications through our Application Engineering Team.



Original T-A Recommended Drilling Data | Metric (mm)

Carbide Inserts

ISO	Material	Hardness (BHN)	Carbide Grade	M/min			Feed Rate (mm/rev) by Diameter				
				 TiN	 TiAlN	 TiCN	9.50 - 12.95	12.98 - 17.52	17.53 - 24.38	24.41 - 35.00	35.01 - 47.80
P	Free Machining Steel 1118, 1215, 12L14, etc.	100 - 150	C5	96	128	115	0.20	0.30	0.38	0.45	0.53
		150 - 200	C5	85	110	100	0.18	0.28	0.35	0.40	0.48
		200 - 250	C5	79	104	90	0.15	0.25	0.33	0.38	0.43
	Low Carbon Steel 1010, 1020, 1025, 1522, 1144, etc.	85 - 125	C5	91	119	110	0.20 ❖	0.25	0.33	0.43	0.48
		125 - 175	C5	79	104	90	0.18 ❖	0.25	0.33	0.40	0.45
		175 - 225	C5	73	95	82	0.15 ❖	0.23	0.30	0.38	0.43
	Medium Carbon Steel 1030, 1040, 1050, 1527, 1140, 1151, etc.	125 - 175	C5	79	104	90	0.18	0.25	0.33	0.40	0.45
		175 - 225	C5	73	95	84	0.15	0.23	0.30	0.38	0.43
		225 - 275	C5	64	83	75	0.13 ❖	0.23	0.30	0.38	0.43
	Alloy Steel 4140, 5140, 8640, etc.	275 - 325	C5	55	70	62	0.13	0.20	0.28	0.35	0.40
		125 - 175	C5	76	99	87	0.18	0.25	0.33	0.40	0.45
		175 - 225	C5	70	92	80	0.15	0.23	0.30	0.38	0.43
225 - 275		C5	64	83	72	0.15	0.23	0.30	0.38	0.43	
275 - 325		C5	61	76	68	0.13	0.20	0.28	0.35	0.40	
High Strength Alloy 4340, 4330V, 300M, etc.	325 - 375	C5	52	67	60	0.10	0.18	0.25	0.33	0.38	
	225 - 300	C5	49	61	55	0.15 ❖	0.23	0.25	0.30	0.38	
	300 - 350	C5	43	55	49	0.13 ❖	0.20	0.23	0.28	0.35	
Structural Steel A36, A285, A516, etc.	350 - 400	C5	37	49	43	0.10 ❖	0.18	0.20	0.25	0.30	
	100 - 150	C5	73	95	84	0.20 ❖	0.28	0.35	0.40	0.45	
	150 - 250	C5	61	76	68	0.15 ❖	0.25	0.30	0.35	0.40	
Tool Steel H-13, H-21, A-4, O-2, S-3, etc.	250 - 350	C5	55	70	62	0.13 ❖	0.23	0.28	0.30	0.35	
	150 - 200	C5	49	67	58	0.10	0.18	0.23	0.28	0.33	
	200 - 250	C5	37	52	45	0.10	0.18	0.23	0.28	0.33	
	S	High Temp Alloy Hastelloy B, Inconel 600, etc.	140 - 220	C2	24	32	28	0.10 ❖	0.18	0.23	0.28
220 - 310			C2	18	26	22	0.10 ❖	0.15	0.20	0.25	0.30
Titanium Alloy		140 - 220	C2	30	38	32	0.10 ❖	0.18	0.23	0.28	0.33
		220 - 310	C2	24	33	28	0.10 ❖	0.15	0.20	0.25	0.30
Aerospace Alloy S82		185 - 275	C2	49	64	57	0.17 ❖	0.22	0.29	0.35	0.40
	275 - 350	C2	37	49	43	0.14 ❖	0.19	0.27	0.30	0.35	
M	Stainless Steel 400 Series 416, 420, etc.	185 - 275	C2	49	64	57	0.17 ❖	0.22	0.29	0.35	0.40
		275 - 350	C2	37	49	43	0.14 ❖	0.19	0.27	0.30	0.35
	Stainless Steel 300 Series 304, 316, 17-4PH, etc.	135 - 185	C2	49	64	57	0.13 ❖	0.17	0.22	0.26	0.30
		185 - 275	C2	37	49	43	0.11 ❖	0.14	0.20	0.22	0.25
	Super Duplex Stainless Steel	135 - 185	C2	25	33	29	0.11 ❖	0.15	0.19	0.23	0.27
185 - 275		C2	19	25	22	0.09 ❖	0.13	0.18	0.20	0.23	

❖ Contact our Application Engineering department for assistance when machining these materials

IMPORTANT: The speeds and feeds listed above are a general starting point for all applications. Refer to the Coolant Recommendation charts for coolant requirements to run at the recommended speeds and feeds. Factory technical assistance is available through our Application Engineering department. See adjustment examples on the following page.

ISO	Material	Hardness (BHN)	Carbide Grade	M/min			Feed Rate (mm/rev) by Diameter				
				 TiN	 TiAlN	 TiCN	9.50 - 12.95	12.98 - 17.52	17.53 - 24.38	24.41 - 35.00	35.01 - 47.80
H	Wear Plate Hardox, AR400, T-1, etc.	400	C5	23	35	30	0.07	0.12	0.20	0.25	0.30
		500	C5	15	26	21	0.05	0.10	0.15	0.20	0.25
		600	C5	11	22	16	0.04	0.08	0.12	0.16	0.20
	Hardened Steel	300 - 400	C5	34	43	39	0.10 ❖	0.18	0.23	0.28	0.33
400 - 500		C5	20	25	23	0.08 ❖	0.15	0.20	0.23	0.28	
K	Nodular, Grey, Ductile Cast Iron	120 - 150	C2, C3	98	141	127	0.20	0.30	0.38	0.48	0.58
		150 - 200	C2, C3	82	122	102	0.18	0.28	0.33	0.43	0.53
		200 - 220	C2, C3	73	110	93	0.15	0.23	0.30	0.38	0.45
		220 - 260	C2, C3	64	95	79	0.13	0.20	0.28	0.33	0.38
		260 - 320	C2, C3	55	83	69	0.13	0.18	0.25	0.28	0.33
N	Cast Aluminum	30	C2	366	460	410	0.25	0.38	0.45	0.50	0.55
		180	C2	244	306	275	0.23	0.33	0.40	0.45	0.50
	Wrought Aluminum	30	C2	366	460	410	0.10	0.15	0.25	0.30	0.36
		180	C2	244	306	275	0.20	0.28	0.36	0.45	0.50
	Aluminum Bronze	100 - 200	C2	85	110	100	0.13	0.20	0.25	0.36	0.42
		200 - 250	C2	64	94	79	0.10	0.15	0.18	0.25	0.33
	Brass	100	C2	130	184	160	0.15	0.23	0.28	0.38	0.45
Copper	60	C2	80	120	100	0.05 ❖	0.08	0.10	0.15	0.25	

❖ Contact our our Application Engineering department for assistance when machining these materials

Deep Hole Drilling Speed and Feed Adjustment

	⚠ Holder Length				
	Extended	Long	Long Plus	XL	3XL
Speed	0.90	0.85	0.80	0.80	0.75
Feed	-	0.95	0.90	0.90	0.90

Recommended Speed and Feed Example

If the recommended speed and feed is 50 M/min and 0.20 mm/rev for a standard length holder, then the speed and feed using a 3XL holder in the same application would be 37.5 M/min and 0.18 mm/rev.

$50 \cdot 0.75 = 37.5 \text{ M/min}$	$0.20 \cdot 0.90 = 0.18 \text{ mm/rev}$
--------------------------------------	---

Formulas

<p>1. $RPM = (318.47 \cdot M/min) / DIA$</p> <p>where:</p> <ul style="list-style-type: none"> RPM = revolutions per minute (rev/min) M/min = speed (M/min) DIA = diameter of drill (mm) 	<p>2. $mm/min = RPM \cdot mm/rev$</p> <p>where:</p> <ul style="list-style-type: none"> mm/min = mm per minute (mm/min) RPM = revolutions per minute (rev/min) mm/rev = feed rate (mm/rev) 	<p>3. $M/min = RPM \cdot 0.003 \cdot DIA$</p> <p>where:</p> <ul style="list-style-type: none"> M/min = speed (M/min) RPM = revolutions per minute (rev/min) DIA = diameter of drill (mm)
---	---	--

⚠ WARNING Tool failure can cause serious injury. To prevent:





- When using holders without support bushing, use a short T-A® holder to establish an initial hole that is a minimum of 2 diameters deep.
- Do not rotate tool holder more than 50 RPM unless it is engaged with the workpiece or fixture.

Visit www.alliedmachine.com/DeepHoleGuidelines for the most up-to-date information and procedures. Factory technical assistance is available for your specific applications through our Application Engineering Team.

A DRILLING
B BORING
C REAMING
D BURNISHING
E THREADING
X SPECIALS

Original T-A Recommended Drilling Data | Metric (mm)

HSS Inserts | Flat Bottom Geometry

ISO	Material	Hardness (BHN)	HSS Grade	M/min			
				 TiN	 TiAlN	 TiCN	 AM200®
P	Free Machining Steel 1118, 1215, 12L14, etc.	100 - 150	HSS	52	76	70	88
		150 - 200	HSS	47	70	62	81
		200 - 250	HSS	43	64	56	74
	Low Carbon Steel 1010, 1020, 1025, 1522, 1144, etc.	85 - 125	HSS	46	67	59	77
		125 - 175	HSS	43	64	56	74
		175 - 225	HSS	40	59	53	68
		225 - 275	HSS	37	56	47	65
	Medium Carbon Steel 1030, 1040, 1050, 1527, 1140, 1151, etc.	125 - 175	HSS	43	64	56	74
		175 - 225	HSS	40	59	53	68
		225 - 275	HSS	37	56	47	65
		275 - 325	SC	34	53	46	61
	Alloy Steel 4140, 5140, 8640, etc.	125 - 175	HSS	40	56	53	65
175 - 225		HSS	37	53	47	61	
225 - 275		HSS	34	47	44	54	
275 - 325		SC	32	44	41	51	
High Strength Alloy 4340, 4330V, 300M, etc.	225 - 300	SC	21	29	26	33	
	300 - 350	SC	15	23	21	27	
	350 - 400	SC	13	20	18	23	
Structural Steel A36, A285, A516, etc.	100 - 150	HSS	36	52	47	60	
	150 - 250	HSS	32	44	41	51	
	250 - 350	SC	26	37	34	43	
Tool Steel H-13, H-21, A-4, O-2, S-3, etc.	150 - 200	SC	21	29	27	33	
	200 - 250	SC	15	24	23	28	
S	High Temp Alloy Hastelloy B, Inconel 600, etc.	140 - 220	SC	7	10	9	13
		220 - 310	SC	6	9	7	10
	Titanium Alloy	140 - 220	SC	10	14	12	16
		220 - 310	SC	8	12	11	14
	Aerospace Alloy S82	185 - 275	SC	20	27	26	34
275 - 350	SC	15	24	21	28		
M	Stainless Steel 400 Series 416, 420, etc.	185 - 275	SC	20	27	26	34
		275 - 350	SC	15	24	21	28
	Stainless Steel 300 Series 304, 316, 17-4PH, etc.	135 - 185	SC	20	27	26	34
		185 - 275	SC	15	24	21	28
	Super Duplex Stainless Steel	135 - 185	SC	20	27	26	34
185 - 275	SC	15	24	21	28		
H	Wear Plate Hardox, AR400, T-1, etc.	400	SC	-	-	-	-
		500	SC	-	-	-	-
		600	N/A	-	-	-	-
	Hardened Steel	300 - 400	SC	13	20	18	24
400 - 500		SC	8	12	10	13	
K	Nodular, Grey, Ductile Cast Iron	120 - 150	HSS	46	67	59	77
		150 - 200	HSS	40	59	53	68
		200 - 220	HSS	34	53	46	61
		220 - 260	SC	29	46	38	53
		260 - 320	SC	24	37	32	43
N	Cast Aluminum	30	HSS	160	228	198	-
		180	HSS	79	122	107	-
	Wrought Aluminum	30	HSS	160	228	198	261
		180	HSS	79	122	107	141
	Aluminum Bronze	100 - 200	SC	40	59	53	70
		200 - 250	SC	29	46	38	50
Brass	100	HSS	46	67	59	78	
Copper	60	SC	35	45	40	53	

❖ Contact our Application Engineering department for assistance when machining these materials

IMPORTANT: The speeds and feeds listed above are a general starting point for all applications. Refer to the Coolant Recommendation charts for coolant requirements to run at the recommended speeds and feeds. Factory technical assistance is available through our Application Engineering department. See adjustment examples on the following page.

Feed Rate (mm/rev) by Diameter					
9.50 - 12.95	12.98 - 17.53	17.53 - 24.38	24.21 - 35.00	35.01 - 47.80	47.85 - 65.99
0.15	0.23	0.28	0.35	0.41	0.46
0.15	0.23	0.28	0.35	0.41	0.46
0.13	0.23	0.28	0.35	0.38	0.43
0.13 ❖	0.20	0.25	0.33	0.38	0.43
0.13 ❖	0.20	0.25	0.33	0.38	0.41
0.10 ❖	0.18	0.23	0.30	0.36	0.41
0.10 ❖	0.18	0.23	0.30	0.36	0.38
0.13	0.20	0.25	0.33	0.38	0.46
0.10	0.18	0.23	0.30	0.36	0.43
0.10	0.18	0.23	0.30	0.36	0.43
0.10	0.15	0.20	0.25	0.33	0.38
0.13	0.18	0.23	0.30	0.33	0.41
0.10	0.18	0.23	0.30	0.33	0.41
0.10	0.15	0.23	0.30	0.33	0.41
0.10	0.13	0.20	0.25	0.30	0.38
0.08	0.13	0.20	0.25	0.30	0.36
0.10 ❖	0.15	0.20	0.23	0.25	0.30
0.08 ❖	0.15	0.20	0.23	0.25	0.30
0.08 ❖	0.13	0.18	0.20	0.23	0.28
0.13 ❖	0.23	0.25	0.30	0.38	0.43
0.10 ❖	0.20	0.23	0.25	0.33	0.41
0.10 ❖	0.18	0.20	0.23	0.30	0.38
0.10	0.13	0.18	0.23	0.25	0.30
0.10	0.13	0.18	0.23	0.23	0.28
0.08 ❖	0.15	0.18	0.23	0.25	0.30
0.08 ❖	0.13	0.15	0.18	0.20	0.25
0.08 ❖	0.15	0.18	0.23	0.25	0.30
0.08 ❖	0.13	0.15	0.18	0.20	0.25
0.13 ❖	0.18	0.20	0.25	0.30	0.38
0.10 ❖	0.15	0.18	0.23	0.25	0.30
0.13 ❖	0.18	0.20	0.25	0.30	0.36
0.10 ❖	0.15	0.18	0.23	0.25	0.28
0.13 ❖	0.18	0.20	0.25	0.30	0.36
0.10 ❖	0.15	0.18	0.23	0.25	0.28
-	-	-	-	-	-
-	-	-	-	-	-
-	-	-	-	-	-
0.08 ❖	0.13	0.18	0.20	0.27	0.38
0.06 ❖	0.10	0.15	0.18	0.23	0.28
0.15	0.25	0.36	0.43	0.48	0.51
0.13	0.23	0.30	0.41	0.46	0.48
0.13	0.20	0.25	0.36	0.41	0.43
0.10	0.15	0.20	0.25	0.33	0.33
0.10	0.13	0.15	0.20	0.25	0.25
0.18	0.28	0.36	0.43	0.46	0.48
0.18	0.28	0.36	0.41	0.43	0.48
0.18	0.28	0.36	0.43	0.46	0.48
0.18	0.28	0.36	0.41	0.43	0.48
0.13	0.23	0.30	0.41	0.51	0.61
0.10	0.15	0.20	0.25	0.31	0.38
0.15	0.25	0.36	0.43	0.53	0.63
0.05 ❖	0.08	0.15	0.20	0.25	0.35

Deep Hole Drilling Speed and Feed Adjustment

	Holder Length				
	Extended	Long	Long Plus	XL	3XL
Speed	0.90	0.85	0.80	0.80	0.75
Feed	-	0.95	0.90	0.90	0.90

Recommended Speed and Feed Example

If the recommended speed and feed is 50 M/min and 0.20 mm/rev for a standard length holder, then the speed and feed using a 3XL holder in the same application would be 37.5 M/min and 0.18 mm/rev.

$50 \cdot 0.75 = 37.5 \text{ M/min}$ $0.20 \cdot 0.90 = 0.18 \text{ mm/rev}$

Formulas

- RPM = (318.47 • M/min) / DIA**

where:
 RPM = revolutions per minute (rev/min)
 M/min = speed (M/min)
 DIA = diameter of drill (mm)
- mm/min = RPM • mm/rev**

where:
 mm/min = mm per minute (mm/min)
 RPM = revolutions per minute (rev/min)
 mm/rev = feed rate (mm/rev)
- M/min = RPM • 0.003 • DIA**

where:
 M/min = speed (M/min)
 RPM = revolutions per minute (rev/min)
 DIA = diameter of drill (mm)





⚠ WARNING Tool failure can cause serious injury. To prevent:

- When using holders without support bushing, use a short T-A® holder to establish an initial hole that is a minimum of 2 diameters deep.
- Do not rotate tool holder more than 50 RPM unless it is engaged with the workpiece or fixture.

Visit www.alliedmachine.com/DeepHoleGuidelines for the most up-to-date information and procedures. Factory technical assistance is available for your specific applications through our Application Engineering Team.





Original T-A Recommended Drilling Data | Metric (mm)

Carbide Inserts | Flat Bottom Geometry

ISO	Material	Hardness (BHN)	Carbide Grade	M/min				Feed Rate (mm/rev) by Diameter			
				 TiN	 TiAlN	 TiCN	 AM200®	9.50 - 12.95	12.98 - 17.53	17.54 - 24.38	24.41 - 35.00
P	Free Machining Steel 1118, 1215, 12L14, etc.	100 - 150	C2	82	110	98	126	0.17	0.26	0.32	0.39
		150 - 200	C2	73	94	85	110	0.15	0.24	0.30	0.35
		200 - 250	C2	67	88	76	102	0.13	0.22	0.28	0.32
	Low Carbon Steel 1010, 1020, 1025, 1522, 1144, etc.	85 - 125	C2	79	102	94	117	0.17 ❖	0.22	0.28	0.37
		125 - 175	C2	67	88	76	102	0.15 ❖	0.22	0.28	0.35
		175 - 225	C2	61	81	70	93	0.13 ❖	0.19	0.26	0.32
	Medium Carbon Steel 1030, 1040, 1050, 1527, 1140, 1151, etc.	225 - 275	C2	55	70	64	81	0.11 ❖	0.19	0.26	0.32
		125 - 175	C2	67	88	76	102	0.15	0.22	0.28	0.35
		175 - 225	C2	61	81	72	93	0.13	0.19	0.26	0.32
	Alloy Steel 4140, 5140, 8640, etc.	225 - 275	C2	55	70	61	81	0.13	0.19	0.26	0.32
		275 - 325	C2	46	61	53	70	0.11	0.17	0.24	0.30
		275 - 325	C2	52	66	58	76	0.11	0.17	0.24	0.30
325 - 375		C2	44	58	50	67	0.09	0.15	0.22	0.28	
325 - 375		C2	44	58	50	67	0.09	0.15	0.22	0.28	
High Strength Alloy 4340, 4330V, 300M, etc.	225 - 300	C2	41	52	47	59	0.13 ❖	0.19	0.22	0.26	
	300 - 350	C2	37	47	41	55	0.11 ❖	0.17	0.19	0.24	
	350 - 400	C2	30	41	37	47	0.09 ❖	0.15	0.17	0.22	
Structural Steel A36, A285, A516, etc.	100 - 150	C2	62	81	72	93	0.17 ❖	0.24	0.30	0.35	
	150 - 250	C2	52	66	58	76	0.13 ❖	0.22	0.28	0.30	
	250 - 350	C2	47	61	53	70	0.11 ❖	0.19	0.25	0.26	
Tool Steel H-13, H-21, A-4, O-2, S-3, etc.	150 - 200	C2	41	58	49	67	0.09	0.15	0.19	0.24	
	200 - 250	C2	30	44	37	50	0.09	0.15	0.19	0.24	
S	High Temp Alloy Hastelloy B, Inconel 600, etc.	140 - 220	C2	21	27	23	32	0.09 ❖	0.15	0.19	0.24
		220 - 310	C2	15	21	18	24	0.09 ❖	0.13	0.17	0.22
	Titanium Alloy	140 - 220	C2	26	33	28	40	0.08 ❖	0.14	0.17	0.20
		220 - 310	C2	21	29	25	30	0.08 ❖	0.12	0.15	0.18
	Aerospace Alloy S82	185 - 275	C2	43	37	50	40	0.15 ❖	0.17	0.25	0.30
275 - 350		C2	33	28	38	32	0.13 ❖	0.15	0.23	0.25	
M	Stainless Steel 400 Series 416, 420, etc.	185 - 275	C2	43	56	50	64	0.15 ❖	0.20	0.25	0.30
		275 - 350	C2	33	43	38	49	0.13 ❖	0.18	0.23	0.25
	Stainless Steel 300 Series 304, 316, 17-4PH, etc.	135 - 185	C2	28	37	33	40	0.13 ❖	0.17	0.21	0.25
		185 - 275	C2	21	28	25	32	0.11 ❖	0.15	0.19	0.21
	Super Duplex Stainless Steel	135 - 185	C2	22	29	26	33	0.10 ❖	0.14	0.17	0.20
185 - 275		C2	17	22	19	26	0.08 ❖	0.12	0.15	0.17	

❖ Contact our Application Engineering department for assistance when machining these materials

IMPORTANT: The speeds and feeds listed above are a general starting point for all applications. Refer to the Coolant Recommendation charts for coolant requirements to run at the recommended speeds and feeds. Factory technical assistance is available through our Application Engineering department. See adjustment examples on the following page.

ISO	Material	Hardness (BHN)	Carbide Grade	M/min				Feed Rate (mm/rev) by Diameter			
				 TiN	 TiAlN	 TiCN	 AM200®	9.50 - 12.95	12.98 - 17.53	17.54 - 24.38	24.41 - 35.00
H	Wear Plate Hardox, AR400, T-1, etc.	400	C2	20	31	26	39	0.06 ❖	0.10	0.16	0.20
		500	C2	13	23	18	31	0.04 ❖	0.08	0.12	0.16
		600	C2	10	19	14	25	0.03 ❖	0.06	0.10	0.13
	Hardened Steel	300 - 400	C2	30	38	34	41	0.08 ❖	0.14	0.18	0.22
400 - 500		C2	18	22	20	33	0.06 ❖	0.12	0.16	0.18	
K	Nodular, Grey, Ductile Cast Iron	120 - 150	C2	82	120	108	137	0.17	0.26	0.32	0.41
		150 - 200	C2	70	104	87	119	0.15	0.24	0.28	0.38
		200 - 220	C2	61	94	79	108	0.13	0.19	0.26	0.32
		220 - 260	C2	55	81	67	93	0.11	0.17	0.24	0.28
		260 - 320	C2	47	70	58	81	0.11	0.15	0.22	0.24
N	Cast Aluminum	30	C2	160	228	198	-	0.22	0.32	0.41	0.43
		180	C2	79	122	107	-	0.19	0.28	0.35	0.39
	Wrought Aluminum	30	C2	292	368	328	390	0.12	0.18	0.23	0.25
		180	C2	195	245	220	260	0.10	0.16	0.20	0.22
	Aluminum Bronze	100 - 200	C2	73	95	85	105	0.10	0.16	0.20	0.29
		200 - 250	C2	55	81	68	87	0.08	0.12	0.14	0.20
Brass	100	C2	112	160	138	185	0.12	0.18	0.22	0.30	
Copper	60	C2	68	105	85	117	0.04 ❖	0.06	0.08	0.12	

❖ Contact our our Application Engineering department for assistance when machining these materials

Deep Hole Drilling Speed and Feed Adjustment

	⚠ Holder Length				
	Extended	Long	Long Plus	XL	3XL
Speed	0.90	0.85	0.80	0.80	0.75
Feed	-	0.95	0.90	0.90	0.90

Recommended Speed and Feed Example

If the recommended speed and feed is 50 M/min and 0.20 mm/rev for a standard length holder, then the speed and feed using a 3XL holder in the same application would be 37.5 M/min and 0.18 mm/rev.

$50 \cdot 0.75 = 37.5 \text{ M/min}$	$0.20 \cdot 0.90 = 0.18 \text{ mm/rev}$
--------------------------------------	---

Formulas

1. $RPM = (318.47 \cdot M/min) / DIA$ where: RPM = revolutions per minute (rev/min) M/min = speed (M/min) DIA = diameter of drill (mm)	2. $mm/min = RPM \cdot mm/rev$ where: mm/min = mm per minute (mm/min) RPM = revolutions per minute (rev/min) mm/rev = feed rate (mm/rev)	3. $M/min = RPM \cdot 0.003 \cdot DIA$ where: M/min = speed (M/min) RPM = revolutions per minute (rev/min) DIA = diameter of drill (mm)
--	--	---

⚠ WARNING Tool failure can cause serious injury. To prevent:

- When using holders without support bushing, use a short T-A® holder to establish an initial hole that is a minimum of 2 diameters deep.
- Do not rotate tool holder more than 50 RPM unless it is engaged with the workpiece or fixture.

Visit www.alliedmachine.com/DeepHoleGuidelines for the most up-to-date information and procedures. Factory technical assistance is available for your specific applications through our Application Engineering Team.

Original T-A Recommended Drilling Data | Metric (mm)

Carbide Inserts | Diamond Coating

Material	Carbide Grade	M/min  Diamond Coating	Feed Rate (mm/rev) by Diameter				
			9.5 - 12.5	13 - 17.5	18 - 24	25 - 35	
Polymer Matrix Composites	Carbon (hard)	N2	305 - 450	0.10 - 0.15	0.20 - 0.25	0.25 - 0.30	0.30 - 0.36
	Carbon Fiber	N2	305 - 450	0.10 - 0.15	0.20 - 0.25	0.25 - 0.30	0.30 - 0.36
	Carbon / Glass Fiber	N2	305 - 450	0.10 - 0.15	0.20 - 0.25	0.25 - 0.30	0.30 - 0.36
	Fiberglass	N2	305 - 450	0.10 - 0.15	0.20 - 0.25	0.25 - 0.30	0.30 - 0.36
	Graphite	N2	305 - 450	0.10 - 0.15	0.20 - 0.25	0.25 - 0.30	0.30 - 0.36
	Plastics	N2	76 - 305	0.10 - 0.15	0.20 - 0.25	0.25 - 0.30	0.30 - 0.36
	Epoxy Resin	N2	76 - 305	0.10 - 0.15	0.20 - 0.25	0.25 - 0.30	0.30 - 0.36
	Bismaleimide Resin	N2	76 - 305	0.10 - 0.15	0.20 - 0.25	0.25 - 0.30	0.30 - 0.36
	Polyester Resin	N2	76 - 305	0.10 - 0.15	0.20 - 0.25	0.25 - 0.30	0.30 - 0.36
	Phenolic Resin	N2	76 - 305	0.10 - 0.15	0.20 - 0.25	0.25 - 0.30	0.30 - 0.36
Rubber	N2	76 - 305	0.10 - 0.15	0.20 - 0.25	0.25 - 0.30	0.30 - 0.36	
Metal Matrix Composites	Aluminum	N2	305	0.20	0.33	0.41	0.51
	Si < 10%	N2	305	0.20	0.33	0.41	0.51
	10% < Si < 15%	N2	259 - 305	0.20	0.33	0.41	0.51
	15% < Si < 20%	N2	198 - 259	0.20	0.33	0.41	0.51
	20% < Si < 25%	N2	152 - 198	0.20	0.33	0.41	0.51
	25% < Si	N2	61 - 152	0.20	0.33	0.41	0.51
	Brass	N2	76 - 152	0.20	0.33	0.41	0.51
	Bronze	N2	76 - 152	0.20	0.33	0.41	0.51
	Copper	N2	30 - 76	0.10 - 0.15	0.20 - 0.25	0.25 - 0.30	0.30 - 0.36
	Copper Alloys	N2	30 - 76	0.10 - 0.15	0.20 - 0.25	0.25 - 0.30	0.30 - 0.36
	Lead Alloys	N2	30 - 76	0.10 - 0.15	0.20 - 0.25	0.25 - 0.30	0.30 - 0.36
	Magnesium Alloys	N2	30 - 76	0.10 - 0.15	0.20 - 0.25	0.25 - 0.30	0.30 - 0.36
Precious Metals	N2	30 - 76	0.10 - 0.15	0.20 - 0.25	0.25 - 0.30	0.30 - 0.36	
Ceramic Matrix Composites	Carbide (green)	N2	15 - 76	0.10 - 0.15	0.20 - 0.25	0.25 - 0.30	0.30 - 0.36
	Ceramic (green)	N2	15 - 76	0.10 - 0.15	0.20 - 0.25	0.25 - 0.30	0.30 - 0.36
	Ceramic (pre-sintered)	N2	15 - 76	0.10 - 0.15	0.20 - 0.25	0.25 - 0.30	0.30 - 0.36

Deep Hole Drilling Speed and Feed Adjustment

	Holder Length				
	Extended	Long	Long Plus	XL	3XL
Speed	0.90	0.85	0.80	0.80	0.75
Feed	-	0.95	0.90	0.90	0.90

Recommended Speed and Feed Example

If the recommended speed and feed is 50 M/min and 0.20 mm/rev for a standard length holder, then the speed and feed using a 3XL holder in the same application would be 37.5 M/min and 0.18 mm/rev.

$$50 \cdot 0.75 = 37.5 \text{ M/min}$$

$$0.20 \cdot 0.90 = 0.18 \text{ mm/rev}$$

⚠ WARNING Tool failure can cause serious injury. To prevent:

- When using holders without support bushing, use a short T-A® holder to establish an initial hole that is a minimum of 2 diameters deep.
- Do not rotate tool holder more than 50 RPM unless it is engaged with the workpiece or fixture.

Visit www.alliedmachine.com/DeepHoleGuidelines for the most up-to-date information and procedures. Factory technical assistance is available for your specific applications through our Application Engineering Team.

IMPORTANT: The speeds and feeds listed above are a general starting point for all applications. Refer to the Coolant Recommendation charts for coolant requirements to run at the recommended speeds and feeds. Factory technical assistance is available through our Application Engineering department. See adjustment examples on the following page.

Tap Drill Information and Formulas | Metric (mm)

Metric Profile Screw Thread

Tap Size	Tap Drill Size	Decimal Equivalent	* Theo % Thread	Probable Mean Oversize	Probable Hole Size	** Probable % Thread
12 x 1.75	10.2mm	0.4016"	79%	0.075mm	10.28mm	76%
12 x 1.75	13/32"	0.4063"	74%	0.075mm	10.40mm	71%
12 x 1.25	27/64"	0.4219"	79%	0.075mm	10.79mm	74%
12 x 1.25	10.8mm	0.4252"	74%	0.075mm	10.88mm	69%
14 x 20	15/32"	0.4688"	81%	0.075mm	11.98mm	78%
14 x 20	12.0mm	0.4724"	77%	0.075mm	12.08mm	74%
14 x 1.5	12.5mm	0.4921"	77%	0.075mm	12.58mm	73%
16 x 2.0	14.0mm	0.5512"	77%	0.075mm	14.08mm	74%
16 x 1.5	14.5mm	0.5709"	77%	0.075mm	14.58mm	73%
16 x 1.5	37/64"	0.5781"	68%	0.075mm	14.76mm	64%
18 x 2.5	15.5mm	0.6102"	77%	0.075mm	15.58mm	75%
18 x 1.5	16.5mm	0.6496"	77%	0.075mm	16.58mm	73%
18 x 1.5	21/32"	0.6563"	68%	0.075mm	16.75mm	64%
20 x 2.5	11/16"	0.6875"	78%	0.075mm	17.54mm	76%
20 x 2.5	17.5mm	0.6890"	77%	0.075mm	17.58mm	74%
20 x 1.5	18.5mm	0.7283"	77%	0.075mm	18.58mm	73%
20 x 1.5	47/64"	0.7344"	69%	0.075mm	18.66mm	65%
22 x 2.5	49/64"	0.7656"	79%	0.075mm	19.52mm	76%
22 x 2.5	19.5mm	0.7677"	77%	0.075mm	19.58mm	75%
22 x 1.5	20.5mm	0.8071"	77%	0.075mm	20.58mm	73%
22 x 1.5	13/16"	0.8125"	70%	0.075mm	20.71mm	66%
24 x 3	13/16"	0.8125"	86%	0.075mm	20.71mm	84%
24 x 3	21.0mm	0.8268"	76%	0.075mm	21.08mm	75%
24 x 2	22.0mm	0.8661"	77%	0.075mm	22.08mm	74%
24 x 2	7/8"	0.8750"	68%	0.075mm	22.30mm	65%
27 x 3	24.0mm	0.9449"	77%	0.075mm	24.08mm	75%

Taper Pipe Thread (NPT)

Tap Size	Tap Drill Size	Decimal Equivalent	Theo % Thread*	Probable Mean Oversize	Probable Hole Size	Probable % Thread**
1/4 - 18	7/16	0.4375	-	0.075mm	11.19mm	-
3/8 - 18	9/16	0.5625	-	0.075mm	14.76mm	-
1/2 - 14	45/64	0.7031	-	0.075mm	18.33mm	-
3/4 - 14	29/32	0.9063	-	0.075mm	23.89mm	-

* Based on nominal tap drill diameter

** Based on .003" probable mean oversize

To calculate the percent of full thread for a given hole diameter:

$$\% \text{ Thread} = \left[\frac{76.93}{\text{Pitch (mm)}} \right] \left[\text{Basic Major Diameter of Thread (mm)} - \text{Drill Hole Size (mm)} \right]$$

Notes

- The above tap drill information represents probable thread percentages for the standard tap drills stocked at Allied Machine. Special insert diameters may be required in order to meet a user specific percentage of thread requirements.
- The .003 probable mean oversize hole condition is based on optimum cutting conditions. Probable percent of full thread may vary based on less ideal cutting conditions.
- The table and equations on this page are found in the *Machinery's Handbook*. Permission to simplify and print the equations is granted by the Editor of the *Machinery's Handbook*.

Formulas

1.	RPM	= (318.47 • M/min) / DIA
	where:	
	RPM	= revolutions per minute (rev/min)
	M/min	= speed (M/min)
	DIA	= diameter of drill (mm)
2.	mm/min	= RPM • mm/rev
	where:	
	mm/min	= mm per minute (mm/min)
	RPM	= revolutions per minute (rev/min)
	mm/rev	= feed rate (mm/rev)
3.	M/min	= RPM • 0.003 • DIA
	where:	
	M/min	= speed (M/min)
	RPM	= revolutions per minute (rev/min)
	DIA	= diameter of drill (mm)
4.	Thrust	= 154 • (mm/rev) • DIA • K _m
	where:	
	Thrust	= axial thrust (N)
	mm/rev	= feed rate (mm/rev)
	DIA	= diameter of drill (mm)
	K _m	= specific cutting energy (bar)
5.	Tool Power	= ((mm/rev) • RPM • K _m • DIA ²) / 210604.8
	where:	
	Tool Power	= tool power (HP)
	mm/rev	= feed rate (mm/rev)
	RPM	= revolutions per minute (rev/min)
	K _m	= specific cutting energy (bar)
	DIA	= diameter of drill (mm)

Material Constants

Type of Material	Hardness	K _m (kPa)
Plain Carbon and Alloy Steel	85 - 200 BHN	5.45
	200 - 275 BHN	6.48
	275 - 375 BHN	6.89
	375 - 425 BHN	7.93
High Temperature Alloys	-	9.93
Stainless Steels	135 - 275 BHN	6.48
	30 - 45 RC	7.45
Cast Iron	100 - 200 BHN	3.45
	200 - 300 BHN	7.45
Copper Alloy	20 - 80 RB	2.96
	80 - 100 RB	4.96
Titanium Alloy	-	4.96
Aluminum Alloy	-	1.52
Magnesium Alloy	-	1.10

Coolant Recommendations | Metric (mm)

HSS Drill Inserts

ISO	Material	Pressure or Flow Rate	9.5 - 12.5	13 - 17	18 - 24	25 - 35	36 - 50	51 - 76	76 - 102
P	Free Machining Steel 1118, 1215, 12L14, etc.	BAR	12 - 13	7 - 8	7 - 10	6 - 8	5 - 7	4	5 - 6
		LPM	9.5 - 9.8	10.6 - 11.4	16.7 - 19.7	26.5 - 30.3	45.4 - 53.0	114 - 125	144 - 167
	Low Carbon Steel 1010, 1020, 1025, 1522, 1144, etc.	BAR	11 - 12	5 - 6	5 - 7	4 - 6	4 - 5	2 - 3	3 - 5
		LPM	9.1 - 9.5	9.1 - 9.8	14.0 - 15.9	22.7 - 26.5	41.6 - 45.4	98 - 114	125 - 144
	Medium Carbon Steel 1030, 1040, 1050, 1527, 1140, 1151, etc.	BAR	11	5 - 6	5 - 6	4 - 5	3 - 5	2 - 3	3 - 5
		LPM	8.7 - 9.1	8.7 - 9.8	13.6 - 15.5	18.9 - 22.7	37.9 - 45.4	98 - 114	125 - 144
	Alloy Steel 4140, 5140, 8640, etc.	BAR	11	5	5 - 6	3 - 5	3 - 4	2	3
		LPM	8.7 - 9.1	8.3 - 9.1	13.2 - 14.8	18.9 - 22.7	31.9 - 41.6	98 - 106	114 - 125
	High Strength Alloy 4340, 4330V, 300M, etc.	BAR	10 - 11	4	3	2	2	1 - 2	2
		LPM	8.7 - 9.1	7.9 - 8.3	11.0 - 11.7	15.1 - 18.9	26.5 - 30.3	79 - 87	87 - 98
	Structural Steel A36, A285, A516, etc.	BAR	11	5 - 6	5 - 6	3 - 4	3	2	3
		LPM	8.7 - 9.1	9.1 - 9.8	13.2 - 14.8	18.9 - 22.7	34.1 - 37.9	87 - 98	114 - 125
Tool Steel H-13, H-21, A-4, O-2, S-3, etc.	BAR	10 - 11	4	3	2	2	1 - 2	2	
	LPM	8.7 - 9.1	7.9 - 8.3	11.0 - 11.7	15.1 - 18.9	26.5 - 30.3	79 - 87	87 - 98	
S	High Temp Alloy Hastelloy B, Inconel 600, etc.	BAR	10 - 11	4 - 5	3 - 4	2	2	2	3
		LPM	8.7 - 9.1	8.3 - 8.7	11.7 - 12.1	15.1 - 18.9	26.5 - 30.3	87 - 98	125
	Titanium Alloy	BAR	10 - 11	4 - 5	3 - 4	2	2	2	3
		LPM	8.7 - 9.1	8.3 - 8.7	11.7 - 12.1	15.1 - 18.9	26.5 - 30.3	87 - 98	125
Aerospace Alloy S82	BAR	10 - 11	4 - 5	3 - 4	2	2	2	3	
	LPM	8.7 - 9.1	8.3 - 8.7	11.7 - 12.1	15.1 - 18.9	26.5 - 30.3	87 - 98	125	
M	Stainless Steel 400 Series 416, 420, etc.	BAR	11.8	5.9	5.2	3.8	3.5	2	3.1
		LPM	9.5	9.8	14	23	38	98	117
	Stainless Steel 300 Series 304, 316, 17-4PH, etc.	BAR	11.8	5.9	5.2	3.8	3.5	2	3.1
		LPM	9.5	9.8	14	23	38	98	117
	Super Duplex Stainless Steel	BAR	11.8	5.9	5.2	3.8	3.5	2	3.1
		LPM	9.5	9.8	14	23	38	98	117
H	Wear Plate Hardox, AR400, T-1, etc.	BAR	10.7	4.2	3.5	2	2	1.7	2
		LPM	9.1	8.3	11.7	19	30	87	98
	Hardened Steel	BAR	10.7	4.2	3.5	2	2	1.7	2
		LPM	9.1	8.3	11.7	19	30	87	98
K	SG / Nodular Cast Iron	BAR	11	4.5	4.2	2.8	2.4	2	2.4
		LPM	9.1	8.7	12.5	19	34	98	106
	Grey / White Iron	BAR	11	4.5	4.2	2.8	2.4	2	2.4
		LPM	9.1	8.7	12.5	19	34	98	106
N	Cast Aluminum	BAR	14.5	12.4	15.8	11	8.6	3.5	5.5
		LPM	10	14	23	34	61	125	159
	Wrought Aluminum	BAR	14.5	12.4	15.8	11	8.6	3.5	5.5
		LPM	10	14	23	34	61	125	159
	Aluminum Bronze	BAR	12.8	8.3	9.65	7.95	6.9	3.5	6.2
		LPM	9.6	11.4	19.7	30.3	53	125	167
	Brass	BAR	11	4.5	4.2	2.8	2.4	2	2.4
		LPM	9.1	8.7	12.5	19	34	98	106
	Copper	BAR	12.8	8.3	9.65	7.95	6.9	3.5	6.2
		LPM	9.6	11.4	19.7	30.3	53	125	167

Deep Hole Drilling Coolant Adjustment

	Holder Length				
	Extended	Long	Long Plus	XL	3XL
Pressure and Flow	1.3	1.5	2	2	3

Recommended Coolant Example

If the recommended pressure and flow is 12 bar and 22 LPM for a standard length holder, then the adjusted pressure and flow for a 3XL holder would be 36 bar and 66 LPM.

$$12 \cdot 3 = 36 \text{ bar} \quad 22 \cdot 3 = 66 \text{ LPM}$$

⚠️ WARNING Tool failure can cause serious injury. To prevent:

- When using holders without support bushing, use a short T-A® holder to establish an initial hole that is a minimum of 2 diameters deep.
- Do not rotate tool holder more than 50 RPM unless it is engaged with the workpiece or fixture.

Visit www.alliedmachine.com/DeepHoleGuidelines for the most up-to-date information and procedures. Factory technical assistance is available for your specific applications through our Application Engineering Team.

IMPORTANT: The coolant pressure and flow rate recommendations above represent a good approximation to obtain optimum tool life and chip evacuation at Allied Machine recommended speeds and feeds. If lower coolant capabilities exist in a drilling application, the T-A® drilling system will still function at reduced penetration rates. Contact our Application Engineering department for a more specific recommendation of coolant requirements and/or speeds and feeds.

Coolant Recommendations | Metric (mm)

Carbide Drill Inserts

ISO	Material	Pressure or Flow Rate	9.5 - 12.5	13 - 17	18 - 24	25 - 35	36 - 47
P	Free Machining Steel 1118, 1215, 12L14, etc.	BAR	17 - 20	17	15	15	20
		LPM	12.2	16.3	25.2	41.5	71.9
	Low Carbon Steel 1010, 1020, 1025, 1522, 1144, etc.	BAR	18	11	11	12	9
		LPM	11.4	13.3	20.6	36.5	62.0
	Medium Carbon Steel 1030, 1040, 1050, 1527, 1140, 1151, etc.	BAR	17	10	10	10	8
		LPM	11.3	12.5	20.0	33.8	57.0
	Alloy Steel 4140, 5140, 8640, etc.	BAR	17	9	10	8	7
		LPM	11.1	12.3	19.3	30.0	55.8
	High Strength Alloy 4340, 4330V, 300M, etc.	BAR	15	5	4	3	3
		LPM	10.4	9.1	12.6	18.8	33.6
Structural Steel A36, A285, A516, etc.	BAR	16	9	8	7	5	
	LPM	10.8	12.0	17.5	27.8	47.1	
Tool Steel H-13, H-21, A-4, O-2, S-3, etc.	BAR	15	5	5	3	3	
	LPM	10.4	9.1	13.6	19.7	36.5	
S	High Temp Alloy Hastelloy B, Inconel 600, etc.	BAR	17	11	12	11	9
		LPM	11.1	13.5	21.9	35.4	62.0
	Titanium Alloy	BAR	17	11	12	11	9
		LPM	11.1	13.5	21.9	35.4	62.0
	Aerospace Alloy S82	BAR	17	11	12	11	9
		LPM	11.1	13.5	21.9	35.4	62.0
M	Stainless Steel 400 Series 416, 420, etc.	BAR	22.7	16.5	17.9	17.2	13.1
		LPM	13	16.3	26.3	44.2	75
	Stainless Steel 300 Series 304, 316, 17-4PH, etc.	BAR	22.7	16.5	17.9	17.2	13.1
		LPM	13	16.3	26.3	44.2	75
	Super Duplex Stainless Steel	BAR	22.7	16.5	17.9	17.2	13.1
		LPM	13	16.3	26.3	44.2	75
H	Wear Plate Hardox, AR400, T-1, etc.	BAR	14.5	5.2	4.8	3.4	3.1
		LPM	10.4	9.1	13.6	19.7	36.5
	Hardened Steel	BAR	14.5	5.2	4.8	3.4	3.1
		LPM	10.4	9.1	13.6	19.7	36.5
K	SG / Nodular Cast Iron	BAR	15.5	7.2	6.2	6.2	5.5
		LPM	10.7	10.8	15.4	26.5	48.7
	Grey / White Iron	BAR	15.5	7.2	6.2	6.2	5.5
		LPM	10.7	10.8	15.4	26.5	48.7
N	Cast Aluminum	BAR	24.1	22	21.7	19.6	13.8
		LPM	13.4	18.8	29	47.2	77
	Wrought Aluminum	BAR	24.1	22	21.7	19.6	13.8
		LPM	13.4	18.8	29	47.2	77
	Aluminum Bronze	BAR	20	16.5	16.5	15.2	12
		LPM	12.2	16.3	25.2	41.5	71.9
	Brass	BAR	24.1	22	21.7	19.6	13.8
		LPM	13.4	18.8	29	47.2	77
	Copper	BAR	20	16.5	16.5	15.2	12
		LPM	12.2	16.3	25.2	41.5	71.9

Deep Hole Drilling Coolant Adjustment

	Holder Length				
	Extended	Long	Long Plus	XL	3XL
Pressure and Flow	1.3	1.5	2	2	3

Recommended Coolant Example

If the recommended pressure and flow is 12 bar and 22 LPM for a standard length holder, then the adjusted pressure and flow for a 3XL holder would be 36 bar and 66 LPM.

$$12 \cdot 3 = 36 \text{ bar}$$

$$22 \cdot 3 = 66 \text{ LPM}$$

⚠️ WARNING Tool failure can cause serious injury. To prevent:

- When using holders without support bushing, use a short T-A® holder to establish an initial hole that is a minimum of 2 diameters deep.
- Do not rotate tool holder more than 50 RPM unless it is engaged with the workpiece or fixture.

Visit www.alliedmachine.com/DeepHoleGuidelines for the most up-to-date information and procedures. Factory technical assistance is available for your specific applications through our Application Engineering Team.

IMPORTANT: The coolant pressure and flow rate recommendations above represent a good approximation to obtain optimum tool life and chip evacuation at Allied Machine recommended speeds and feeds. If lower coolant capabilities exist in a drilling application, the T-A® drilling system will still function at reduced penetration rates. Contact our Application Engineering department for a more specific recommendation of coolant requirements and/or speeds and feeds.

Troubleshooting Guide

	Potential Problem																						
	Accelerated corner wear	Barber pole	Bell mouth hole	Insert chipping	Blue chips	Build Up Edge (BUE)	Chatter	Chip packing	Chipping of point	Damaged or broken tools	Excessive margin wear	High flank wear	Hole lead off	Hole out of position	Hole out of round	Notching of insert	Oversize hole	Poor hole finish	Poor tool life	Power spikes - Load meter	Retract spiral	Step burned on insert	
Setup Condition	1	2	3	4	5	6	7	8	9	10	11	12	13	14	15	16	17	18	19	20	21	22	Possible Solutions
<p>⚠ Use of Standard, Standard Plus, Extended, Long, Long Plus, XL, and 3XL holders.</p> <p>See page 8 for Deep Hole Drilling guidelines.</p>		2	3				7		9				13	14			17				21		<ul style="list-style-type: none"> Start with short holder and drill a minimum depth equal to 2xD (see page # for instructions). Spot hole with stub tool of same or greater included angle as T-A® drill insert. Decrease feed a minimum of 50% until establishing full diameter. Use special holder with wear pads or chrome bearing area to work with drill bushings.
Starting on an inclined surface.							7		9	10	11		13		15						21		<ul style="list-style-type: none"> Spot face surface to provide a flat entry surface. Spot hole with stub tool of same or greater included angle as T-A® drill insert. Decrease feed a minimum of 50% until establishing full diameter. Use special holder with wear pads or chrome bearing area to work with drill bushings.
Worn or misaligned spindle (lathe, screw machine, chucker).	1		3				7		9	10	11		13				17	18			21		<ul style="list-style-type: none"> Align spindle and turret or tailstock. Repair spindle. Spot hole with stub tool of same or greater included angle as T-A® drill insert.
Use of low rigidity machine tools (radial drills, multi-spindle drill press, etc.).		2	3	4			7		9	10			13	14							21		<ul style="list-style-type: none"> Spot hole with stub tool of same or greater included angle as T-A® drill insert. Reduce penetration rate to fall within the physical limits of the machine or setup (NOTICE: Do not reduce feed below threshold of good chip formation). Use special holder with wear pads or chrome bearing area to work with drill bushings. Use tougher tool steel grades with high wear resistant coatings.
Poor work piece support.		2		4			7			10	11				15				18		21		<ul style="list-style-type: none"> Provide additional support for the work piece.Reduce penetration rate to fall within the physical limits of the machine or setup (NOTICE: Do not reduce feed below threshold of good chip formation). Use tougher tool steel grades with high wear resistant coatings.
Flood coolant, low coolant pressure or low coolant volume.	1				5	6		8		10		11					17	18	18	20		21	<ul style="list-style-type: none"> Run coolant through tool holder when drilling greater than one times diameter. Increase coolant pressure and volume through the tool holder. Reduce penetration rate to fall within the coolant limitations (NOTICE: Do not reduce feed below threshold of good chip formation). Add a peck cycle to help clear chips.

1. WARNING Tool failure can cause serious injury. To prevent:



- When using holders without support bushing, use a short T-A® holder to establish an initial hole that is a minimum of 2 diameters deep.
- Do not rotate tool holder more than 50 RPM unless it is engaged with the workpiece or fixture.

Visit www.alliedmachine.com/DeepHoleGuidelines for the most up-to-date information and procedures. Factory technical assistance is available for your specific applications through our Application Engineering Team.

	Potential Problem																						
	Accelerated corner wear	Barber pole	Bell mouth hole	Insert chipping	Blue chips	Build Up Edge (BUE)	Chatter	Chip packing	Chipping of point	Damaged or broken tools	Excessive margin wear	High flank wear	Hole lead off	Hole out of position	Hole out of round	Notching of insert	Oversize hole	Poor hole finish	Poor tool life	Power spikes - Load meter	Retract spiral	Step burned on insert	
Setup Condition	1	2	3	4	5	6	7	8	9	10	11	12	13	14	15	16	17	18	19	20	21	22	Possible Solutions
Interrupted cuts. Entry or exit surfaces that are not perpendicular to the spindle (draft angles, stepped surfaces, cross holes, and cast or forged surfaces).				4			7		9	10	11		13	14	15		17	18	19				<ul style="list-style-type: none"> Pre-mill (spot face) entry or exit surface to remove interruption. Spot hole with stub tool of same or greater included angle as T-A® drill insert. Decrease feed as much as 50% through entry or exit interruption. Use short holders in low impact entry cuts.
Material harder than expected or running tools beyond recommended speeds.	1				5	6			10		12								19			22	<ul style="list-style-type: none"> Reduce speed if a step is worn in the insert, calculate SFM at the worn diameter. Reduce this value by 10% and apply this new value to the original tool diameter. Increase coolant pressure and volume. Improve coolant condition by use of quality products and regular maintenance. Select an insert grade (premium, super cobalt, or carbide) or coating (TiAlN, TiCN, or AM200®) that is more wear and heat resistant.
Poor material micro-structure or foreign particles (forgings and castings that have not been normalized or annealed, poorly prepared steel, flame cut parts and sand casting).				4		6			10		12	13				16			19				<ul style="list-style-type: none"> Compare performance of other tools for similar wear problems, which may indicate poor micro-structure. Anneal or normalize parts to improve micro-structure for machining. To improve tool life in materials with poor micro-structure, try carbide grades. For hard spots or inclusions, use the tougher insert steel grade with high wear resistant coatings (TiAlN, TiCN, AM200®). Reduce feeds (NOTICE: Do not reduce feed below threshold of good chip formation).
Poor chip control.								8	10	11		13					17	18	19	20			<ul style="list-style-type: none"> Increase feed to recommended levels. Contact Allied Application Engineering team for technical recommendations. Increase coolant pressure and volume. Improve coolant condition by use of quality products and regular maintenance. See pages #-# for special purpose geometries.
Spot drilled holes with included angle less than that matching T-A® or cored holes.	1			4			7						13			16			19				<ul style="list-style-type: none"> Spot hole with short tool of same or greater included angle as T-A® drill insert. Reduce feed (NOTICE: Do not reduce feed below threshold of good chip formation) If possible, drill from solid.
Use of high wear resistant insert grades.				4					10														<ul style="list-style-type: none"> Use tougher grade of T-A® (from carbide to cobalt to HSS). See wear versus toughness chart on page #. Increase rigidity of setup.

Deep Hole Drilling Guidelines

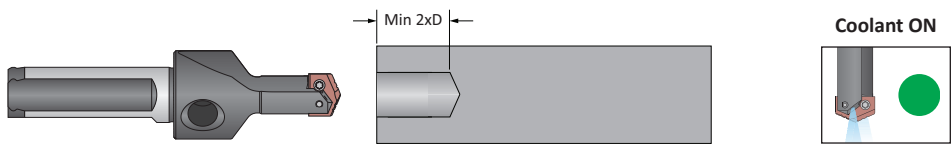
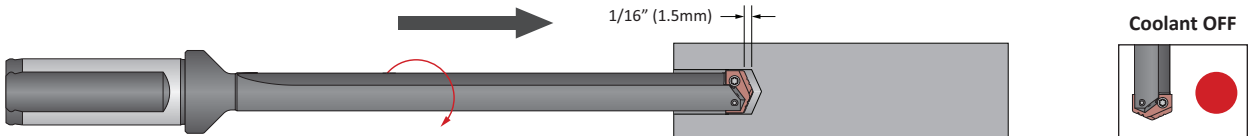
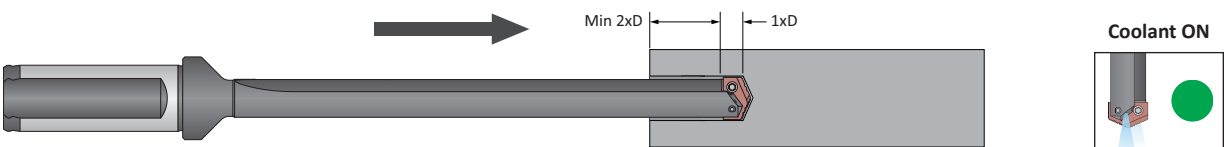
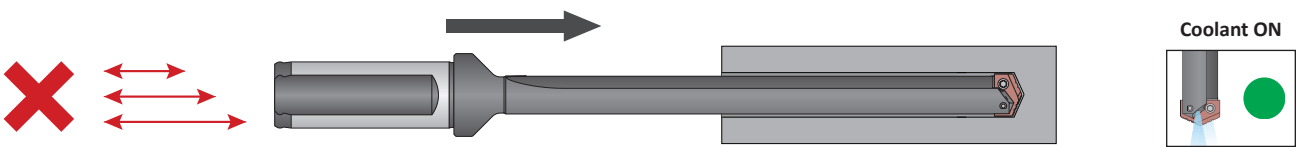
For Lengths Greater Than 9xD (including Extended, Long, XL, 3XL, and Special Length)

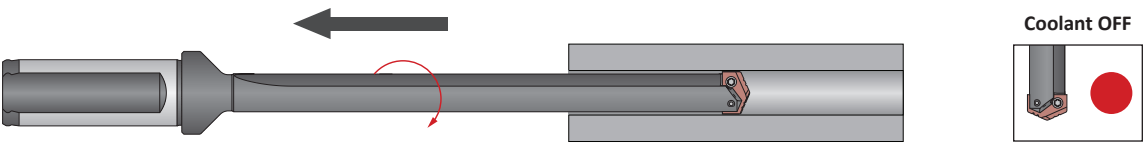
A DRILLING	<p>1. Pilot Hole 100 % RPM 100% IPR (mm/rev)</p>	<p>Establish the pilot hole using the same diameter short drill to a depth of 2xD minimum. Utilize a pilot drill with the same or larger included point angle.</p>	
B BORING	<p>2. Feed-in 50 RPM max 12 IPM (300 mm/min)</p>	<p>Feed the longer drill within 1/16" (1.5mm) short of the established pilot hole bottom at a maximum of 50 RPM and 12 IPM (300 mm/min) feed rate.</p>	
C REAMING	<p>3. Deep Hole Transition Drilling 50 % RPM 75% IPR (mm/rev)</p>	<p>Drill additional 1xD past the bottom of the pilot hole at 50% reduction of recommended speed and 25% reduction of recommended feed. Minimum of 1 second dwell is required to meet full speed before feeding.</p>	
D BURNISHING	<p>4. Deep Hole Drilling - Blind 100% RPM 100% IPR (mm/rev)</p>	<p>Drill to full depth at recommended speed and feed for longer drill according to Allied speed and feed charts. No peck cycle recommended.</p>	
E THREADING	<p>5. Deep Hole Drilling - at Breakout 50% RPM 75% IPR (mm/rev)</p>	<p>For through holes only: Reduce speed by 50% and feed by 25% prior to breakout. Do not breakout more than 1/8" (3mm) past the full diameter of the drill.</p>	
X SPECIALS	<p>6. Drill Retract 50 RPM max</p>	<p>Reduce speed to a maximum of 50 RPM before retracting from the hole.</p>	

1. WARNING Tool failure can cause serious injury. To prevent:

- When using holders without support bushing, use a short T-A® holder to establish an initial hole that is a minimum of 2 diameters deep.
- Do not rotate tool holder more than 50 RPM unless it is engaged with the workpiece or fixture.

Visit www.alliedmachine.com/DeepHoleGuidelines for the most up-to-date information and procedures. Factory technical assistance is available for your specific applications through our Application Engineering Team.

This page left intentionally blank

- A**
DRILLING
- B**
BORING
- C**
REAMING
- D**
BURNISHING
- E**
THREADING
- X**
SPECIALS

High Performance / Universal

Replaceable Spade Drill Insert Drilling System

► Diameter Range: 0.9688" - 8.5000"



Since the Beginning

The Universal spade drill is the original design that launched Allied Machine into the holemaking industry. After the T-A® was introduced, customers who already owned the Universal style holders wanted the same benefits offered by the T-A without having to invest in an entirely new system.

The High Performance (HP) insert was created to provide similar performance as the T-A. The HP insert (along with an adapter for larger sizes) fits into existing Universal style holders.

When the customers speak, we listen.

Applicable Industries



Aerospace



Agriculture



Automotive



Energy



Firearms



General
Machining



Oil & Gas

Your safety and the safety of others is very important. This catalog contains important safety messages. Always read and follow all safety precautions.



This triangle is a safety hazard symbol. It alerts you to potential safety hazards that can cause tool failure and serious injury.

When you see this symbol in the catalog, look for a related safety message that may be near this triangle or referred to in the nearby text.

There are safety signal words also used in the catalog. Safety messages follow these words.

WARNING

WARNING (shown above) means that failure to follow the precautions in this message could result in tool failure and serious injury.

NOTICE means that failure to follow the precautions in this message could result in damage to the tool or machine but not result in personal injury.

NOTE and **IMPORTANT** are also used. These are important that you read and follow but are not safety-related.

Visit www.alliedmachine.com for the most up-to-date information and procedures.

High Performance / Universal Drilling System Contents

Reference Icons

The following icons will appear throughout the catalog to help you navigate between products.

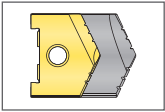

High Performance / Universal Inserts

Refers to the range of inserts that connect with the corresponding holders

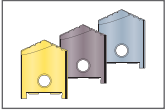

Universal Insert Coating Options

Details and overview of the different coatings available for Universal spade drill inserts

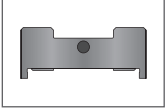

Insert Adapter Information

Detailed information regarding the corresponding adapter item

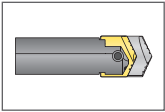

High Performance / Universal Holders

Refers to the range of holders that connect with the corresponding inserts

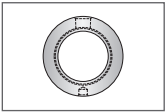

Rotary Coolant Adapter (RCA) Information

Detailed instructions and information regarding the corresponding RCA part

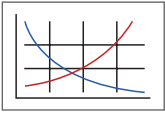

Recommended Cutting Data

Speed and feed recommendations for optimum and safe drilling

Series	Diameter Range - Imperial (in)
A	0.9688 - 1.2500
B	1.2500 - 1.7500
C	1.5000 - 2.3750
D	2.0000 - 2.8750
E	2.5000 - 3.3750
F	3.0000 - 3.8750
G	3.5000 - 4.5000
H ¹ - H ²	4.0000 - 5.0000
H ³ - H ⁹	5.1250 - 8.5000

Introduction Information

System Overview	2 - 3
Product Nomenclature	4 - 5

Drill Series

A Series	6 - 9
B Series	10 - 13
C Series	14 - 17
D Series	18 - 21
E Series	22 - 25
F Series	26 - 29
G Series	30 - 33
H Series	34 - 37

Accessories

Adapters and Blade-Loc Screws	38 - 39
Rotary Coolant Adapters (RCA)	40
Top Mounting Plate	41
Cylindrical Grinding Fixtures	41

Recommended Cutting Data

Regrind Charts	42 - 43
High Performance Inserts	44 - 45
Universal Inserts	46 - 47
Deep Hole Drilling Guidelines	48

System Overview | Inserts

A
DRILLING
B
BORING
C
REAMING
D
BURNISHING
E
THREADING
X
SPECIALS

High Performance Inserts

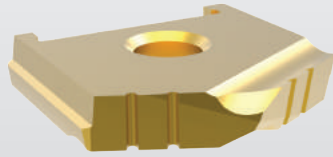

A - C Series

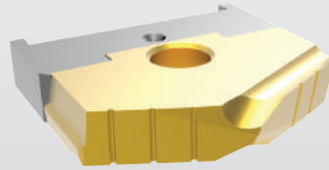

D - H Series
(adapter required)

High Performance Inserts

- Increase production 100 - 500% compared to uncoated Universal spade drill inserts
- Fit into Universal style holders
- Available in TiN and TiAlN coatings
- Single-piece design (A - C series) eliminates the need for adapters, which maximizes tool performance in these smaller sizes

Universal Inserts

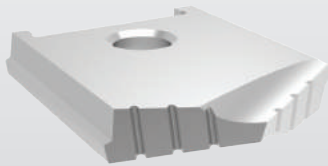

130° CPM-M4
130° CPM-T15

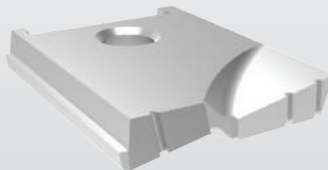

Flat Bottom

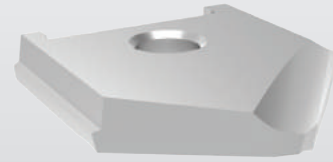

90° Spot and Chamfer

Universal Inserts

- Standard inserts stocked uncoated
- Also available in TiN, TiAlN, and TiCN coatings, which improve tool life when compared to uncoated inserts

TiN Coating	
Ordering Code: T	Example: 10224-0116 T

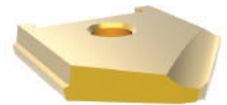
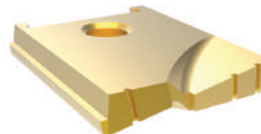
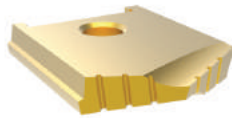

TiAlN Coating	
Ordering Code: A	Example: 10224-0116 A

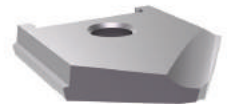
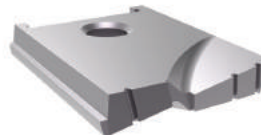
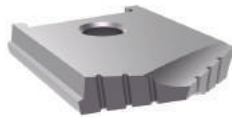

TiCN Coating	
Ordering Code: N	Example: 10224-0116 N

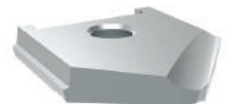
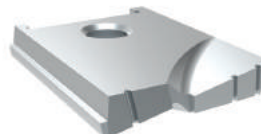
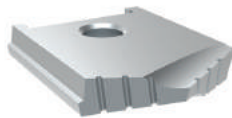



Straight Shank Holders

- Stub (#125)
- Short (#150)
- Short (#100)
- Standard (#200)
- Long (#250)



Taper Shank Holders

- Short (#300)
- Short (#300 TSC)
- Short (#400 SR)
- Standard (#500 SR)
- Long (#600 SR)
- XL (#700 SR)



50 NMTB Shank Holders

- Short (#300)
- Short (#400)
- Standard (#500 SR)



Adapter*
for High Performance D - H series inserts only



*For detailed information and set-up for adapters and Blade-Loc screw assembly, see page A40: 38

Product Nomenclature

High Performance Spade Drill Inserts

1	02	8	T	-	0406
1	2	3	4		5

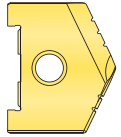

1. Spade Drill Insert	2. Material	3. Series	4. Coating	5. Diameter (by 1/32")
1 = Spade drill insert	02 = High speed steel	1 = A series 2 = B series 3 = C series 4 = D series 5 = E series 6 = F series 7 = G series 8 = H series	T = TiN A = TiAlN N = TiCN	0406 = Inch 4.3593 = Decimal

Universal Spade Drill Inserts

1	02	8	4	-	0406	T
1	2	3	4		5	6

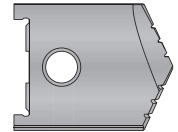

1. Spade Drill Insert	2. Insert Style	3. Series	4. Material
1 = Spade drill insert	02 = 130° Spade 04 = Flat Bottom 12 = 90° Spot and Chamfer	1 = A series 2 = B series 3 = C series 4 = D series 5 = E series 6 = F series 7 = G series 8 = H1 - H2 series 9 = H3 - H9 series J = J series	2 = M-2 (J series only) 4 = High speed steel (SPM-M4 HSS) 5 = High speed steel (CPM-T15 HSS)* *discontinued

5. Diameter (by 1/32")	6. Coating
0406 = Inch 4.3593 = Decimal	Blank = Uncoated T = TiN A = TiAlN N = TiCN

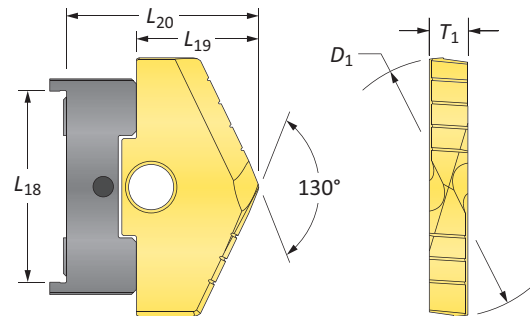

Reference Key

Symbol	Attribute
D ₁	Insert diameter
L ₁₈	Holder locating area
L ₁₉	Reference length
L ₂₀	High Performance length (with adapter)
T ₁	Thickness

A DRILLING
B BORING
C REAMING
D BURNISHING
E THREADING
X SPECIALS

Product Nomenclature

High Performance / Universal Spade Drill Insert Holders

2	22	8	1	-	0006
1	2	3	4		5



1. Holder	2. Classification	3. Series																					
2 = Drill holder	<table border="0"> <tr> <td>Straight Shank</td> <td>Taper Shank</td> <td>50 NMTB Shank</td> </tr> <tr> <td>02 = Stub #125 (NC)</td> <td>14 = Short #300 (NC)</td> <td>24 = Short #300 (NC)</td> </tr> <tr> <td>04 = Short #150 (NC)</td> <td>15 = Short #300 (TSC)</td> <td>26 = Short #400 (C)</td> </tr> <tr> <td>06 = Short #100 (C)</td> <td>16 = Short #400 (C)</td> <td>28 = Standard #500 (C)</td> </tr> <tr> <td>08 = Standard #200 (C)</td> <td>18 = Standard #500 (C)</td> <td></td> </tr> <tr> <td>10 = Long #250 (C)</td> <td>20 = Long #600 (C)</td> <td></td> </tr> <tr> <td></td> <td>22 = XL #700 SR (C)</td> <td></td> </tr> </table> <p style="text-align: center;"><i>C = Coolant NC = No Coolant TSC = Through Shank Coolant</i></p>	Straight Shank	Taper Shank	50 NMTB Shank	02 = Stub #125 (NC)	14 = Short #300 (NC)	24 = Short #300 (NC)	04 = Short #150 (NC)	15 = Short #300 (TSC)	26 = Short #400 (C)	06 = Short #100 (C)	16 = Short #400 (C)	28 = Standard #500 (C)	08 = Standard #200 (C)	18 = Standard #500 (C)		10 = Long #250 (C)	20 = Long #600 (C)			22 = XL #700 SR (C)		1 = A series 2 = B series 3 = C series 4 = D series 5 = E series 6 = F series 7 = G series 8 = H series
Straight Shank	Taper Shank	50 NMTB Shank																					
02 = Stub #125 (NC)	14 = Short #300 (NC)	24 = Short #300 (NC)																					
04 = Short #150 (NC)	15 = Short #300 (TSC)	26 = Short #400 (C)																					
06 = Short #100 (C)	16 = Short #400 (C)	28 = Standard #500 (C)																					
08 = Standard #200 (C)	18 = Standard #500 (C)																						
10 = Long #250 (C)	20 = Long #600 (C)																						
	22 = XL #700 SR (C)																						

4. Holder Style	5. Shank Size and Configuration																					
1 = Universal	<table border="0"> <tr> <td>Straight Shank</td> <td>Taper Shank</td> <td>NMTB Shank</td> </tr> <tr> <td>0750 = 0.750" Straight Shank</td> <td>0002 = #2 Morse Taper Shank</td> <td>0050 = 50 NMTB Shank</td> </tr> <tr> <td>1000 = 1.000" Straight Shank</td> <td>0003 = #3 Morse Taper Shank</td> <td></td> </tr> <tr> <td>1250 = 1.250" Straight Shank</td> <td>0004 = #4 Morse Taper Shank</td> <td></td> </tr> <tr> <td>1500 = 1.500" Straight Shank</td> <td>0005 = #5 Morse Taper Shank</td> <td></td> </tr> <tr> <td>2000 = 2.000" Straight Shank</td> <td>0006 = #6 Morse Taper Shank</td> <td></td> </tr> <tr> <td>3000 = 3.000" Straight Shank</td> <td></td> <td></td> </tr> </table>	Straight Shank	Taper Shank	NMTB Shank	0750 = 0.750" Straight Shank	0002 = #2 Morse Taper Shank	0050 = 50 NMTB Shank	1000 = 1.000" Straight Shank	0003 = #3 Morse Taper Shank		1250 = 1.250" Straight Shank	0004 = #4 Morse Taper Shank		1500 = 1.500" Straight Shank	0005 = #5 Morse Taper Shank		2000 = 2.000" Straight Shank	0006 = #6 Morse Taper Shank		3000 = 3.000" Straight Shank		
Straight Shank	Taper Shank	NMTB Shank																				
0750 = 0.750" Straight Shank	0002 = #2 Morse Taper Shank	0050 = 50 NMTB Shank																				
1000 = 1.000" Straight Shank	0003 = #3 Morse Taper Shank																					
1250 = 1.250" Straight Shank	0004 = #4 Morse Taper Shank																					
1500 = 1.500" Straight Shank	0005 = #5 Morse Taper Shank																					
2000 = 2.000" Straight Shank	0006 = #6 Morse Taper Shank																					
3000 = 3.000" Straight Shank																						

Reference Key

Symbol	Attribute
D_1	Insert diameter
D_2	Shank diameter
L_1	Overall length
L_{3HP}	Reference length (High Performance)
L_{3U}	Reference length (Universal)
L_4	Flute length
L_7	Shank length
P_1	Pipe tap

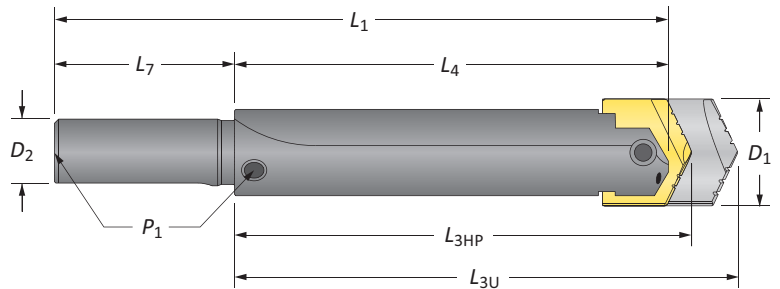





A DRILLING
 B BORING
 C REAMING
 D BURNISHING
 E THREADING
 X SPECIALS

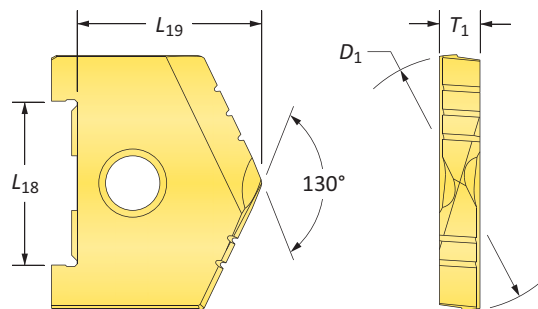
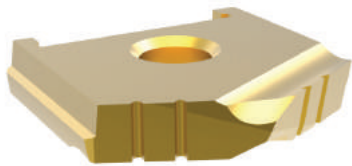

High Performance Spade Drill Inserts

A Series | Diameter Range: 0.9688" - 1.3750"



Series	D_1 inch		Inserts					
	Fraction	Decimal	L_{18}	L_{19}	T_1	TiN Part No.	TiAlN Part No.	TiCN Part No.
A	31/32	0.9688	3/4	7/8	3/16	1021T-0031	1021A-0031	1021N-0031
	1	1.0000	3/4	7/8	3/16	1021T-0100	1021A-0100	1021N-0100
	1-1/32	1.0313	3/4	7/8	3/16	1021T-0101	1021A-0101	1021N-0101
	1-1/16	1.0625	3/4	7/8	3/16	1021T-0102	1021A-0102	1021N-0102
	1-3/32	1.0938	3/4	7/8	3/16	1021T-0103	1021A-0103	1021N-0103
	1-1/8	1.1250	3/4	7/8	3/16	1021T-0104	1021A-0104	1021N-0104
	1-5/32	1.1563	3/4	7/8	3/16	1021T-0105	1021A-0105	1021N-0105
	1-3/16	1.1875	3/4	7/8	3/16	1021T-0106	1021A-0106	1021N-0106
	1-7/32	1.2188	3/4	7/8	3/16	1021T-0107	1021A-0107	1021N-0107
A Oversize	1-1/4	1.2500	3/4	7/8	3/16	1021T-0108	1021A-0108	1021N-0108
	1-9/32	1.2813	3/4	7/8	3/16	1021T-0109	1021A-0109	1021N-0109
	1-5/16	1.3125	3/4	7/8	3/16	1021T-0110	1021A-0110	1021N-0110
	1-11/32	1.3438	3/4	7/8	3/16	1021T-0111	1021A-0111	1021N-0111
	1-3/8	1.3750	3/4	7/8	3/16	1021T-0112	1021A-0112	1021N-0112

Inserts sold in multiples of 1

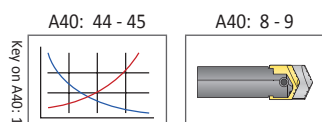





Sizes not shown are available upon request.
When ordering, please follow the example below:

Inch:	7-63/64", 130° CPM-M4 (H8 series) = use Part No. 10294-7.9843
Decimal:	6.391", 130° CPM-M4 (H5 series) = use Part No. 10294-6.3910

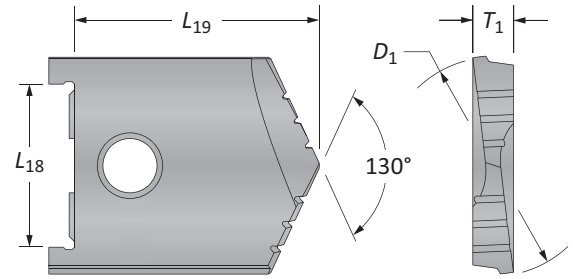
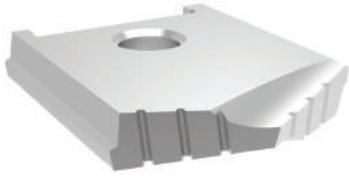
Universal Spade Drill Inserts

A Series | Diameter Range: 0.9688" - 1.3750"



Series	D ₁ inch		Inserts						
	Fraction	Decimal	L ₁₈	L ₁₉	T ₁	130° CPM-M4	130° CPM-T15*	Flat Bottom	90° Spot & Chamfer
A	31/32	0.9688	3/4	1-5/32	3/16	10214-0031	-	-	POR
	1	1.0000	3/4	1-5/32	3/16	10214-0100	-	10414-0100	POR
	1-1/32	1.0313	3/4	1-5/32	3/16	10214-0101	-	-	POR
	1-1/16	1.0625	3/4	1-5/32	3/16	10214-0102	10215-0102	10414-0102	POR
	1-3/32	1.0938	3/4	1-5/32	3/16	10214-0103	-	-	POR
	1-1/8	1.1250	3/4	1-5/32	3/16	10214-0104	10215-0104	10414-0104	POR
	1-5/32	1.1563	3/4	1-5/32	3/16	10214-0105	-	-	POR
	1-3/16	1.1875	3/4	1-5/32	3/16	10214-0106	10215-0106	10414-0106	POR
	1-7/32	1.2188	3/4	1-5/32	3/16	10214-0107	-	-	POR
1-1/4	1.2500	3/4	1-5/32	3/16	10214-0108	-	10414-0108	11214-0108	
A Oversize	1-9/32	1.2813	3/4	1-5/32	3/16	10214-0109	-	-	-
	1-5/16	1.3125	3/4	1-5/32	3/16	10214-0110	-	-	-
	1-11/32	1.3438	3/4	1-5/32	3/16	10214-0111	-	-	-
	1-3/8	1.3750	3/4	1-5/32	3/16	10214-0112	-	-	-

*Discontinued

NOTE: POR = Priced on request

Flat Bottom

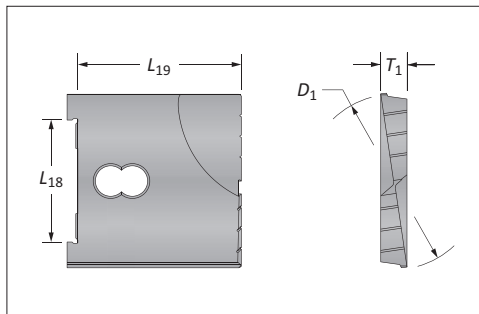

90° Spot & Chamfer

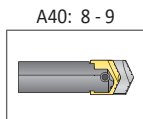
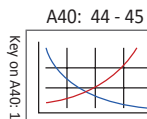
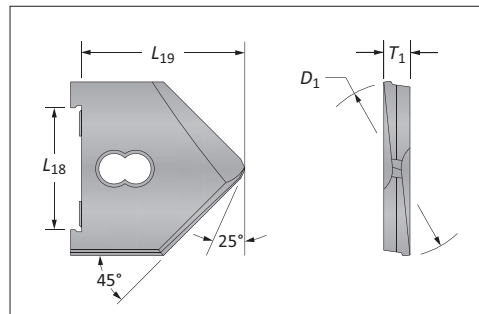

Sizes not shown are available upon request.
When ordering, please follow the example below:

Inch:	1-17/64", 130° CPM-M4 (B series) = use Part No. 10224-1.2656
Decimal:	1.5110", 130° Flat Bottom (C series) = use Part No. 10434-1.5110



High Performance / Universal Spade Drill Insert Holders

A Series

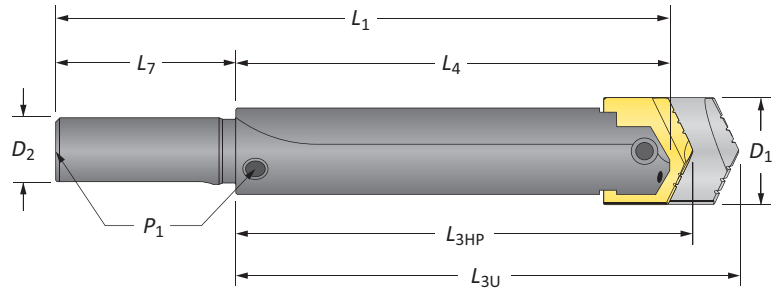

Straight Shank

Length	D_1	Holder				Shank				Style	Part No.
		L_{3HP}	L_{3U}	L_4	L_1	D_2	L_7	P_1			
Short	31/32 - 1-3/8	3-1/4	3-17/32	3	6-1/2	3/4	3-1/2	-	#150	20411-0750	
Short	31/32 - 1-3/8	3-1/4	3-17/32	3	6-1/2	1	3-1/2	-	#150	20411-1000	
Short	31/32 - 1-3/8	3-1/4	3-17/32	3	6-1/2	1	3-1/2	1/8	#100	20611-1000	
Short	31/32 - 1-3/8	3-1/4	3-17/32	3	6-1/2	1-1/2	3-1/2	1/8	#100	20611-1500	
Standard	31/32 - 1-3/8	8	8-9/32	7-3/4	11-1/4	3/4	3-1/2	1/8	#200	20811-0750	
Standard	31/32 - 1-3/8	8	8-9/32	7-3/4	11-1/4	1	3-1/2	1/8	#200	20811-1000	
Standard	31/32 - 1-3/8	8	8-9/32	7-3/4	11-1/4	1-1/2	3-1/2	1/8	#200	20811-1500	
Long	31/32 - 1-3/8	15-1/4	15-17/32	15	18-1/2	1	3-1/2	1/8	#250	21011-1000	

Connection Accessories



Clamping Screw

#10-24 x 5/8"



Blade-Loc Screw

-

A40: 6 - 7



i = Imperial (in)
m = Metric (mm)

WARNING Refer to Speed and Feed charts for recommended adjustments to speeds and feeds. Refer to page A40: 48 for deep hole drilling guidelines in this section of the catalog. Visit www.alliedmachine.com/DeepHoleGuidelines for the most up-to-date information and procedures. Factory technical assistance is available for your specific applications through our Application Engineering Team.

High Performance / Universal Spade Drill Insert Holders

A Series

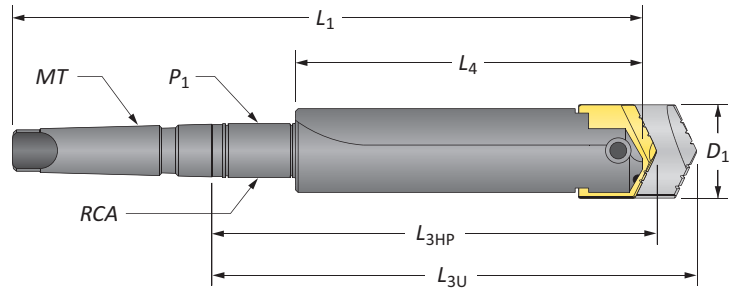

Taper Shank

Length	D ₁	Holder				Shank				Part No.
		L _{3HP}	L _{3U}	L ₄	L ₁	MT	P ₁	RCA	Style	
Short	31/32 - 1-3/8	3-7/16	3-23/32	3	6-7/8	#3	-	-	#300	21411-0003
Short	31/32 - 1-3/8	3-1/2	3-13/16	3	7-7/8	#4	-	-	#300	21411-0004
Short	31/32 - 1-3/8	3-7/16	3-23/32	3	6-7/8	#3	-	-	#300 TSC	21511-0003*
i Short	31/32 - 1-3/8	5-3/16	5-15/32	3	9-9/16	#4	1/4	2T-4SR	#400 SR	21611-0004
Standard	31/32 - 1-3/8	9-15/16	10-7/32	7-3/4	14-5/16	#4	1/4	2T-4SR	#500 SR	21811-0004
Long	31/32 - 1-3/8	17-3/16	17-15/32	15	21-9/16	#4	1/4	2T-4SR	#600 SR	22011-0004
XL	31/32 - 1-3/8	23-3/16	23-15/32	21	27-9/16	#4	1/4	2T-4SR	#700 SR	22211-0004

*Through shank coolant, coolant inlet diameter = 1/4"

Rotary Coolant Adapter (RCA) and Accessories

ID	OD	L ₁	Driving Rod Thread	P ₁	Part No.*	RCA O-Rings	
						Kit Part No.**	Replacements
i 1-1/4	2-1/2	1-3/8	3/8 - NC	1/4	2T-4SR	2T1-4SR	2T1-4OR-10

*RCA comes complete with (1) RCA, (2) O-rings, (2) snap rings, and (2) thrust washers

**RCA Repair Kit includes (2) O-rings, (2) snap rings, and (2) thrust washers

⚠ Refer to page A40: 40 for proper RCA assembly and safety information

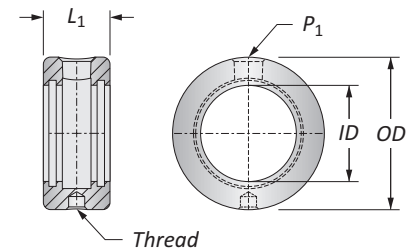

Connection Accessories

Clamping Screw	Blade-Loc Screw
#10-24 x 5/8"	-

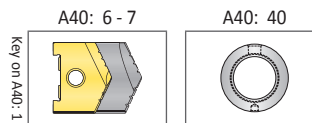





i = Imperial (in)
m = Metric (mm)
 O-rings sold in packs of 10

⚠ WARNING Refer to Speed and Feed charts for recommended adjustments to speeds and feeds. Refer to page A40: 48 for deep hole drilling guidelines in this section of the catalog. Visit www.alliedmachine.com/DeepHoleGuidelines for the most up-to-date information and procedures. Factory technical assistance is available for your specific applications through our Application Engineering Team.

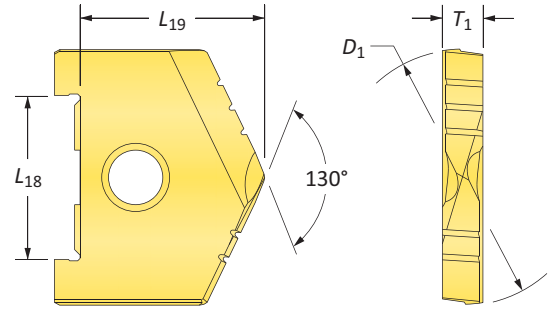
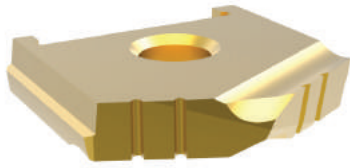
High Performance Spade Drill Inserts

B Series | Diameter Range: 1.2500" - 1.7500"



Series	D ₁ inch		Insert					
	Fraction	Decimal	L ₁₈	L ₁₉	T ₁	TiN Part No.	TiAlN Part No.	TiCN Part No.
B	1-1/4	1.2500	1-1/16	1-3/32	9/32	1022T-0108	1022A-0108	1022N-0108
	1-9/32	1.2813	1-1/16	1-3/32	9/32	1022T-0109	1022A-0109	1022N-0109
	1-5/16	1.3125	1-1/16	1-3/32	9/32	1022T-0110	1022A-0110	1022N-0110
	1-11/32	1.3438	1-1/16	1-3/32	9/32	1022T-0111	1022A-0111	1022N-0111
	1-3/8	1.3750	1-1/16	1-3/32	9/32	1022T-0112	1022A-0112	1022N-0112
	1-13/32	1.4063	1-1/16	1-3/32	9/32	1022T-0113	1022A-0113	1022N-0113
	1-7/16	1.4375	1-1/16	1-3/32	9/32	1022T-0114	1022A-0114	1022N-0114
	1-15/32	1.4688	1-1/16	1-3/32	9/32	1022T-0115	1022A-0115	1022N-0115
B Oversize	1-1/2	1.5000	1-1/16	1-3/32	9/32	1022T-0116	1022A-0116	1022N-0116
	1-17/32	1.5313	1-1/16	1-3/32	9/32	1022T-0117	1022A-0117	1022N-0117
	1-9/16	1.5625	1-1/16	1-3/32	9/32	1022T-0118	1022A-0118	1022N-0118
	1-19/32	1.5938	1-1/16	1-3/32	9/32	1022T-0119	1022A-0119	1022N-0119
	1-5/8	1.6250	1-1/16	1-3/32	9/32	1022T-0120	1022A-0120	1022N-0120
	1-21/32	1.6563	1-1/16	1-3/32	9/32	1022T-0121	1022A-0121	1022N-0121
	1-11/16	1.6875	1-1/16	1-3/32	9/32	1022T-0122	1022A-0122	1022N-0122
	1-23/32	1.7188	1-1/16	1-3/32	9/32	1022T-0123	1022A-0123	1022N-0123
	1-3/4	1.7500	1-1/16	1-3/32	9/32	1022T-0124	1022A-0124	1022N-0124

Inserts sold in multiples of 1

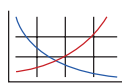
A40: 44 - 45  Key on A40: 1

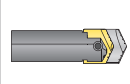
A40: 12 - 13 

Sizes not shown are available upon request.
When ordering, please follow the example below:

Inch:	7-63/64", 130° CPM-M4 (H8 series) = use Part No. 10294-7.9843
Decimal:	6.391", 130° CPM-M4 (H5 series) = use Part No. 10294-6.3910



Universal Spade Drill Inserts

B Series | Diameter Range: 1.2500" - 1.7500"

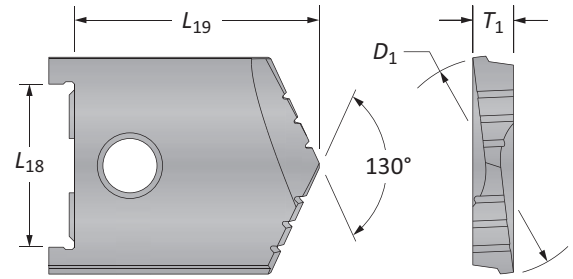
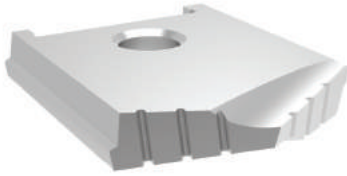

Series	D ₁ inch		Insert						
	Fraction	Decimal	L ₁₈	L ₁₉	T ₁	130° CPM-M4	130° CPM-T15*	Flat Bottom	90° Spot & Chamfer
B	1-1/4	1.2500	1-1/16	1-13/32	9/32	10224-0108	-	10424-0108	POR
	1-9/32	1.2813	1-1/16	1-13/32	9/32	10224-0109	-	-	POR
	1-5/16	1.3125	1-1/16	1-13/32	9/32	10224-0110	10225-0110	10424-0110	POR
	1-11/32	1.3438	1-1/16	1-13/32	9/32	10224-0111	-	-	POR
	1-3/8	1.3750	1-1/16	1-13/32	9/32	10224-0112	-	10424-0112	POR
	1-13/32	1.4063	1-1/16	1-13/32	9/32	10224-0113	-	-	POR
	1-7/16	1.4375	1-1/16	1-13/32	9/32	10224-0114	-	10424-0114	POR
	1-15/32	1.4688	1-1/16	1-13/32	9/32	10224-0115	-	-	POR
	1-1/2	1.5000	1-1/16	1-13/32	9/32	10224-0116	-	10424-0116	11224-0116
B Oversize	1-17/32	1.5313	1-1/16	1-13/32	9/32	10224-0117	-	-	-
	1-9/16	1.5625	1-1/16	1-13/32	9/32	10224-0118	-	-	-
	1-19/32	1.5938	1-1/16	1-13/32	9/32	10224-0119	-	-	-
	1-5/8	1.6250	1-1/16	1-13/32	9/32	10224-0120	-	-	-
	1-21/32	1.6563	1-1/16	1-13/32	9/32	10224-0121	-	-	-
	1-11/16	1.6875	1-1/16	1-13/32	9/32	10224-0122	-	-	-
	1-23/32	1.7188	1-1/16	1-13/32	9/32	10224-0123	-	-	-
	1-3/4	1.7500	1-1/16	1-13/32	9/32	10224-0124	-	-	-

*Discontinued

NOTE: POR = Priced on request

Flat Bottom

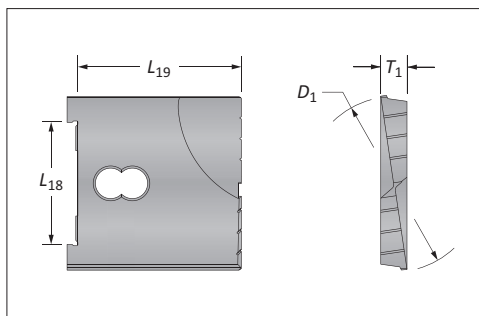

90° Spot & Chamfer

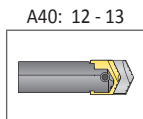
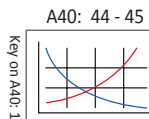
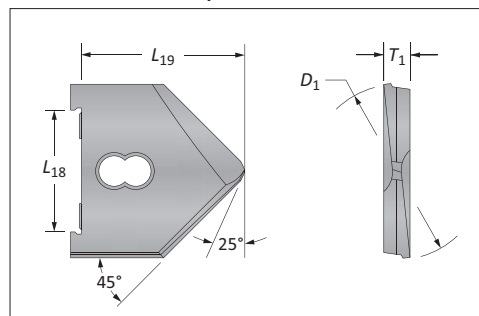

Sizes not shown are available upon request.
When ordering, please follow the example below:

Inch:	1-17/64", 130° CPM-M4 (B series) = use Part No. 10224-1.2656
Decimal:	1.5110", 130° Flat Bottom (C series) = use Part No. 10434-1.5110

High Performance / Universal Spade Drill Insert Holders

B Series

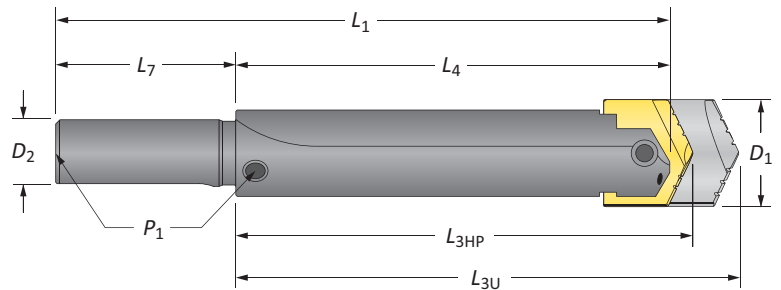

Straight Shank

Length	D ₁ Range	Holder				Shank				Style	Part No.
		L _{3HP}	L _{3U}	L ₄	L ₁	D ₂	L ₇	P ₁			
Short	1-1/4 - 1-3/4	3-25/32	4-3/32	3-1/2	7	1	3-1/2	-	#150	20421-1000	
Short	1-1/4 - 1-3/4	3-25/32	4-3/32	3-1/2	7	1	3-1/2	1/4	#100	20621-1000	
Short	1-1/4 - 1-3/4	3-25/32	4-3/32	3-1/2	7	1-1/4	3-1/2	1/4	#100	20621-1250	
i Short	1-1/4 - 1-3/4	3-25/32	4-3/32	3-1/2	7	1-1/2	3-1/2	1/4	#100	20621-1500	
Standard	1-1/4 - 1-3/4	8-13/32	8-23/32	8-1/8	11-5/8	1	3-1/2	1/4	#200	20821-1000	
Standard	1-1/4 - 1-3/4	8-13/32	8-23/32	8-1/8	11-5/8	1-1/4	3-1/2	1/4	#200	20821-1250	
Standard	1-1/4 - 1-3/4	8-13/32	8-23/32	8-1/8	11-5/8	1-1/2	3-1/2	1/4	#200	20821-1500	
Long	1-1/4 - 1-3/4	15-9/32	15-19/32	15	18-1/2	1-1/4	3-1/2	1/4	#250	21021-1250	

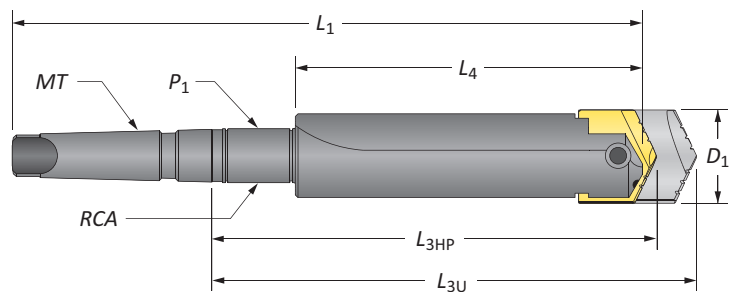

Taper Shank

Length	D ₁ Range	Holder				Shank				Style	Part No.
		L _{3HP}	L _{3U}	L ₄	L ₁	MT	P ₁	RCA			
Short	1-1/4 - 1-3/4	3-31/32	4-9/32	3-1/2	7-3/8	#3	-	-	#300	21421-0003	
Short	1-1/4 - 1-3/4	4-1/32	4-11/32	3-1/2	8-3/8	#4	-	-	#300	21421-0004	
Short	1-1/4 - 1-3/4	4-1/32	4-11/32	3-1/2	8-3/8	#4	-	-	#300 TSC	21521-0004*	
i Short	1-1/4 - 1-3/4	5-23/32	6-1/32	3-1/2	10-1/16	#4	1/4	2T-4SR	#400 SR	21621-0004	
Standard	1-1/4 - 1-3/4	10-11/32	10-21/32	8-1/8	14-11/16	#4	1/4	2T-4SR	#500 SR	21821-0004	
Long	1-1/4 - 1-3/4	17-7/32	17-17/32	15	21-9/16	#4	1/4	2T-4SR	#600 SR	22021-0004	
XL	1-1/4 - 1-3/4	24-7/32	24-17/32	22	28-9/16	#4	1/4	2T-4SR	#700 SR	22221-0004	

*Through shank coolant, coolant inlet diameter = 5/16"

Connection Accessories

<p>Clamping Screw 1/4"-20 x 7/8</p>	<p>Blade-Loc Screw -</p>
--	-------------------------------------

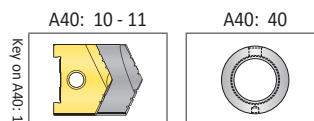

i = Imperial (in)
m = Metric (mm)

WARNING Refer to Speed and Feed charts for recommended adjustments to speeds and feeds. Refer to page A40: 48 for deep hole drilling guidelines in this section of the catalog. Visit www.alliedmachine.com/DeepHoleGuidelines for the most up-to-date information and procedures. Factory technical assistance is available for your specific applications through our Application Engineering Team.

High Performance / Universal Spade Drill Insert Holders

B Series

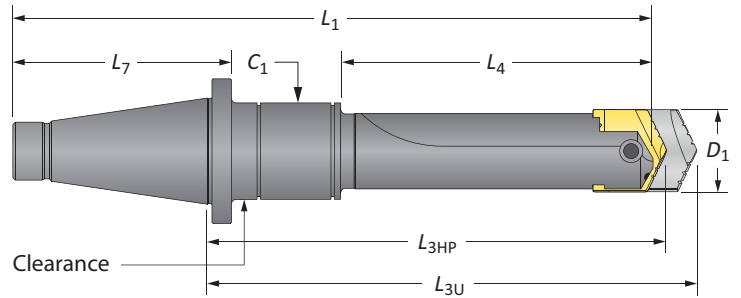

50 NMTB Shank*

Length	D ₁ Range	Holder				Shank					Part No.
		L _{3HP}	L _{3U}	L ₄	L ₁	MT	L ₇	C ₁	RCA	Style	
Short	1-1/4 - 1-3/4	5-13/32	5-23/32	4	10-1/8	50	5-5/8	–	–	#300	22421-0050
Short	1-1/4 - 1-3/4	7-3/32	7-13/32	4	11-13/16	50	5-5/8	3/8	2T-5SR	#400	22621-0050
Short	1-1/4 - 1-3/4	11-19/32	11-29/32	8-1/2	16-5/16	50	5-5/8	3/8	2T-5SR	#500	22821-0050

*All NMTB shank holders are discontinued items. Items listed are available (subject to prior sale) at list prices until stock is depleted. Once stock is depleted, items are available as quoted specials only.

Rotary Coolant Adapter (RCA) and Accessories

ID	OD	L ₁	Driving Rod Thread	P ₁	Part No.*	RCA O-Rings	
						Kit Part No.**	Replacements
1-1/4	2-1/2	1-3/8	3/8 - NC	1/4	2T-4SR	2T1-4SR	2T1-4OR-10
1-3/4	3	1-3/8	3/8 - NC	1/4	2T-5SR	2T1-5SR	2T1-5OR-10

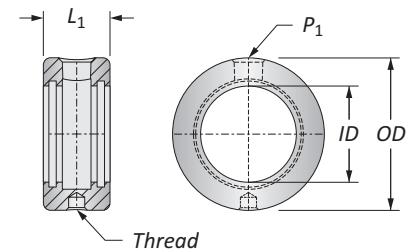

*RCA comes complete with (1) RCA, (2) O-rings, (2) snap rings, and (2) thrust washers

**RCA Repair Kit includes (2) O-rings, (2) snap rings, and (2) thrust washers

▲ Refer to page A40: 40 for proper RCA assembly and safety information

Connection Accessories

Clamping Screw	Blade-Loc Screw
1/4"-20 x 7/8	–

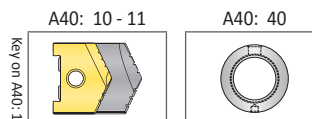

ⓘ = Imperial (in)
 ⓘ = Metric (mm)
 O-rings sold in packs of 10

WARNING RCA rotation during drilling can cause hose and/or hose fitting failure, machinery damage, and/or serious injury. To prevent, use RCA and positive stop studs when drilling. Factory technical assistance is also available for your specific applications.



High Performance Spade Drill Inserts

C Series | Diameter Range: 1.5000" - 2.3750"

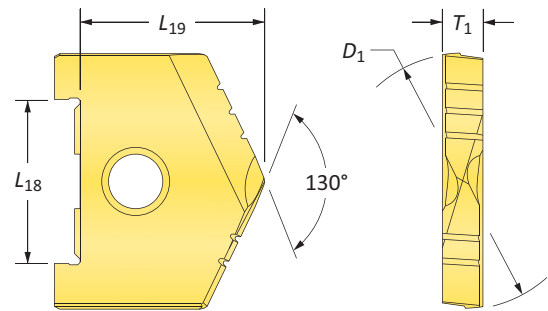
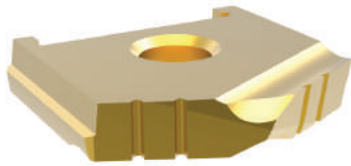

Series	D ₁ inch		Insert			TiN Part No.	TiAlN Part No.	TiCN Part No.
	Fraction	Decimal	L ₁₈	L ₁₉	T ₁			
C	1-1/2	1.5000	1-1/4	1-19/64	5/16	1023T-0116	1023A-0116	1023N-0116
	1-17/32	1.5313	1-1/4	1-19/64	5/16	1023T-0117	1023A-0117	1023N-0117
	1-9/16	1.5625	1-1/4	1-19/64	5/16	1023T-0118	1023A-0118	1023N-0118
	1-19/32	1.5938	1-1/4	1-19/64	5/16	1023T-0119	1023A-0119	1023N-0119
	1-5/8	1.6250	1-1/4	1-19/64	5/16	1023T-0120	1023A-0120	1023N-0120
	1-21/32	1.6563	1-1/4	1-19/64	5/16	1023T-0121	1023A-0121	1023N-0121
	1-11/16	1.6875	1-1/4	1-19/64	5/16	1023T-0122	1023A-0122	1023N-0122
	1-23/32	1.7188	1-1/4	1-19/64	5/16	1023T-0123	1023A-0123	1023N-0123
	1-3/4	1.7500	1-1/4	1-19/64	5/16	1023T-0124	1023A-0124	1023N-0124
	1-25/32	1.7813	1-1/4	1-19/64	5/16	1023T-0125	1023A-0125	1023N-0125
	1-13/16	1.8125	1-1/4	1-19/64	5/16	1023T-0126	1023A-0126	1023N-0126
	1-27/32	1.8438	1-1/4	1-19/64	5/16	1023T-0127	1023A-0127	1023N-0127
	1-7/8	1.8750	1-1/4	1-19/64	5/16	1023T-0128	1023A-0128	1023N-0128
	1-29/32	1.9063	1-1/4	1-19/64	5/16	1023T-0129	1023A-0129	1023N-0129
	1-15/16	1.9375	1-1/4	1-19/64	5/16	1023T-0130	1023A-0130	1023N-0130
	1-31/32	1.9688	1-1/4	1-19/64	5/16	1023T-0131	1023A-0131	1023N-0131
2	2.0000	1-1/4	1-19/64	5/16	1023T-0200	1023A-0200	1023N-0200	
C Oversize	2-1/32	2.0313	1-1/4	1-19/64	5/16	1023T-0201	1023A-0201	1023N-0201
	2-1/16	2.0625	1-1/4	1-19/64	5/16	1023T-0202	1023A-0202	1023N-0202
	2-3/32	2.0938	1-1/4	1-19/64	5/16	1023T-0203	1023A-0203	1023N-0203
	2-1/8	2.1250	1-1/4	1-19/64	5/16	1023T-0204	1023A-0204	1023N-0204
	2-5/32	2.1563	1-1/4	1-19/64	5/16	1023T-0205	1023A-0205	1023N-0205
	2-3/16	2.1875	1-1/4	1-19/64	5/16	1023T-0206	1023A-0206	1023N-0206
	2-7/32	2.2188	1-1/4	1-19/64	5/16	1023T-0207	1023A-0207	1023N-0207
	2-1/4	2.2500	1-1/4	1-19/64	5/16	1023T-0208	1023A-0208	1023N-0208
	2-9/32	2.2813	1-1/4	1-19/64	5/16	1023T-0209	1023A-0209	1023N-0209
	2-5/16	2.3125	1-1/4	1-19/64	5/16	1023T-0210	1023A-0210	1023N-0210
	2-11/32	2.3438	1-1/4	1-19/64	5/16	1023T-0211	1023A-0211	1023N-0211
	2-3/8	2.3750	1-1/4	1-19/64	5/16	1023T-0212	1023A-0212	1023N-0212

Inserts sold in multiples of 1

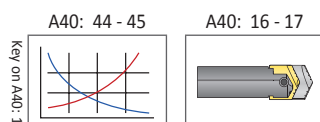

Sizes not shown are available upon request.





When ordering, please follow the example below:

Inch:	7-63/64", 130° CPM-M4 (H8 series) = use Part No. 10294-7.9843
Decimal:	6.391", 130° CPM-M4 (H5 series) = use Part No. 10294-6.3910

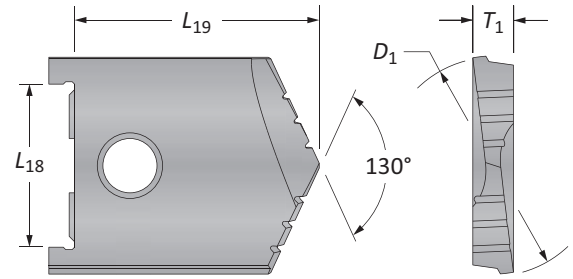
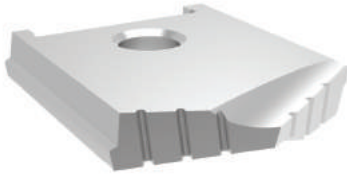
Universal Spade Drill Inserts

C Series | Diameter Range: 1.5000" - 2.3750"



Series	D ₁ inch		Insert						
	Fraction	Decimal	L ₁₈	L ₁₉	T ₁	130° CPM-M4	130° CPM-T15*	Flat Bottom	90° Spot & Chamfer
C	1-1/2	1.5000	1-1/4	2	5/16	10234-0116	10235-0116	10434-0116	POR
	1-17/32	1.5313	1-1/4	2	5/16	10234-0117	-	-	POR
	1-9/16	1.5625	1-1/4	2	5/16	10234-0118	10235-0118	10434-0118	POR
	1-19/32	1.5938	1-1/4	2	5/16	10234-0119	-	-	POR
	1-5/8	1.6250	1-1/4	2	5/16	10234-0120	10235-0120	10434-0120	POR
	1-21/32	1.6563	1-1/4	2	5/16	10234-0121	-	-	POR
	1-11/16	1.6875	1-1/4	2	5/16	10234-0122	10235-0122	10434-0122	POR
	1-23/32	1.7188	1-1/4	2	5/16	10234-0123	-	-	POR
	1-3/4	1.7500	1-1/4	2	5/16	10234-0124	10235-0124	10434-0124	POR
	1-25/32	1.7813	1-1/4	2	5/16	10234-0125	-	-	POR
	1-13/16	1.8125	1-1/4	2	5/16	10234-0126	10235-0126	10434-0126	POR
	1-27/32	1.8438	1-1/4	2	5/16	10234-0127	-	-	POR
	1-7/8	1.8750	1-1/4	2	5/16	10234-0128	10235-0128	10434-0128	POR
	1-29/32	1.9063	1-1/4	2	5/16	10234-0129	-	-	POR
	1-15/16	1.9375	1-1/4	2	5/16	10234-0130	10235-0130	10434-0130	POR
	1-31/32	1.9688	1-1/4	2	5/16	10234-0131	-	-	POR
	2	2.0000	1-1/4	2	5/16	10234-0200	10235-0200	10434-0200	11234-0200
	C Oversize	2-1/32	2.0313	1-1/4	2	5/16	10234-0201	-	-
2-1/16		2.0625	1-1/4	2	5/16	10234-0202	-	-	-
2-3/32		2.0938	1-1/4	2	5/16	10234-0203	-	-	-
2-1/8		2.1250	1-1/4	2	5/16	10234-0204	-	-	-
2-5/32		2.1563	1-1/4	2	5/16	10234-0205	-	-	-
2-3/16		2.1875	1-1/4	2	5/16	10234-0206	-	-	-
2-7/32		2.2188	1-1/4	2	5/16	10234-0207	-	-	-
2-1/4		2.2500	1-1/4	2	5/16	10234-0208	-	-	-
2-9/32		2.2813	1-1/4	2	5/16	10234-0209	-	-	-
2-5/16		2.3125	1-1/4	2	5/16	10234-0210	-	-	-
2-11/32		2.3438	1-1/4	2	5/16	10234-0211	-	-	-
2-3/8		2.3750	1-1/4	2	5/16	10234-0212	-	-	-

*Discontinued | NOTE: POR = Priced on request

Flat Bottom

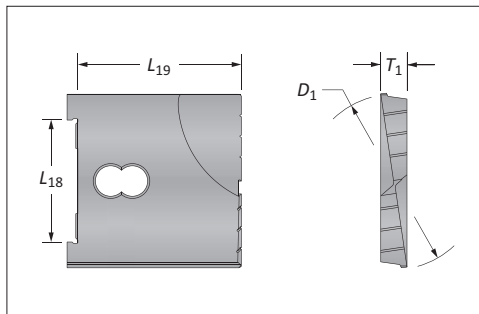

90° Spot & Chamfer

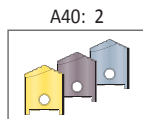
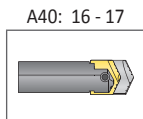
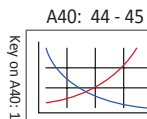
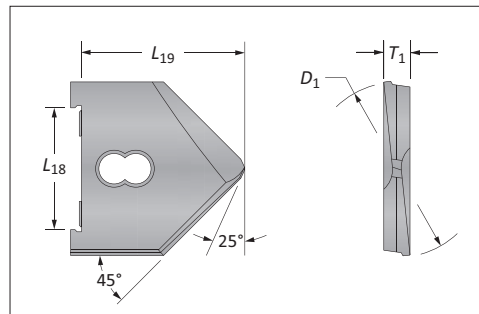

Sizes not shown are available upon request.
When ordering, please follow the example below:

Inch:	1-17/64", 130° CPM-M4 (B series) = use Part No. 10224-1.2656
Decimal:	1.5110", 130° Flat Bottom (C series) = use Part No. 10434-1.5110

A
DRILLING
B
BORING
C
REAMING
D
BURNISHING
E
THREADING
X
SPECIALS

High Performance / Universal Spade Drill Insert Holders

C Series

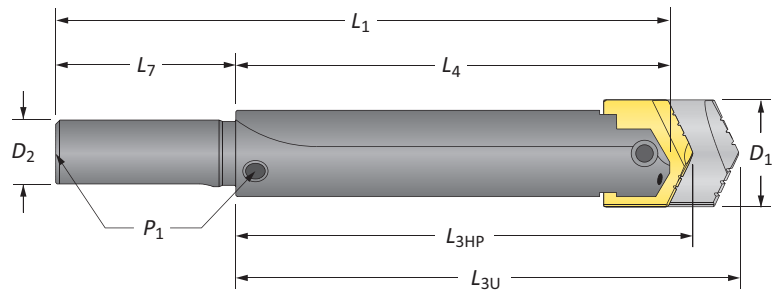

Straight Shank

Length	D_1	Holder				Shank				Style	Part No.
		L_{3HP}	L_{3U}	L_4	L_1	D_2	L_7	P_1			
Stub	1-1/2 - 2-3/8	2-19/64	3	2	6	1-1/2	4	–	#125	20231-1500	
Short	1-1/2 - 2-3/8	4-19/64	5	4	8	1-1/4	4	–	#150	20431-1250	
Short	1-1/2 - 2-3/8	4-19/64	5	4	8	1-1/4	4	1/4	#100	20631-1250	
i Short	1-1/2 - 2-3/8	4-19/64	5	4	8	1-1/2	4	1/4	#100	20631-1500	
Standard	1-1/2 - 2-3/8	8-51/64	9-1/2	8-1/2	12-1/2	1-1/4	4	1/4	#200	20831-1250	
Standard	1-1/2 - 2-3/8	8-51/64	9-1/2	8-1/2	12-1/2	1-1/2	4	1/4	#200	20831-1500	
Long	1-1/2 - 2-3/8	18-19/64	19	18	22	1-1/2	4	1/4	#250	21031-1500	

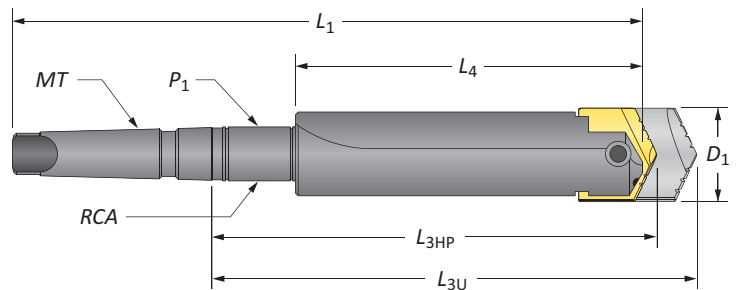

Taper Shank

Length	D_1	Holder				Shank				Style	Part No.
		L_{3HP}	L_{3U}	L_4	L_1	MT	P_1	RCA			
Short	1-1/2 - 2-3/8	4-35/64	5-1/4	4	8-7/8	#4	–	–	#300	21431-0004	
Short	1-1/2 - 2-3/8	4-35/64	5-1/4	4	8-7/8	#4	–	–	#300 TSC	21531-0004*	
Short	1-1/2 - 2-3/8	4-35/64	5-1/4	4	10-1/8	#5	–	–	#300 TSC	21531-0005*	
Short	1-1/2 - 2-3/8	6-15/64	6-15/64	4	10-9/16	#4	1/4	2T-4SR	#400 SR	21631-0004	
i Standard	1-1/2 - 2-3/8	10-47/64	11-7/16	8-1/2	15-1/16	#4	1/4	2T-4SR	#500 SR	21831-0004	
Standard	1-1/2 - 2-3/8	10-47/64	11-7/16	8-1/2	16-5/16	#5	1/4	2T-5SR	#500 SR	21831-0005	
Long	1-1/2 - 2-3/8	20-15/64	20-5/16	18	24-9/16	#4	1/4	2T-4SR	#600 SR	22031-0004	
Long	1-1/2 - 2-3/8	20-15/64	20-5/16	18	25-13/16	#5	1/4	2T-5SR	#600 SR	22031-0005	
XL	1-1/2 - 2-3/8	28-15/64	28-15/16	26	32-9/16	#4	1/4	2T-4SR	#700 SR	22231-0004	
XL	1-1/2 - 2-3/8	28-15/64	28-15/16	26	33-13/16	#5	1/4	2T-5SR	#700 SR	22231-0005	

*Through shank coolant, coolant inlet diameter = 5/16"

Connection Accessories

<p>Clamping Screw 1/4"-20 x 1</p>	<p>Blade-Loc Screw –</p>
--	-------------------------------------

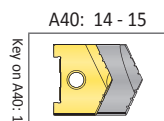

i = Imperial (in)
m = Metric (mm)

WARNING Refer to Speed and Feed charts for recommended adjustments to speeds and feeds. Refer to page A40: 48 for deep hole drilling guidelines in this section of the catalog. Visit www.alliedmachine.com/DeepHoleGuidelines for the most up-to-date information and procedures. Factory technical assistance is available for your specific applications through our Application Engineering Team.

High Performance / Universal Spade Drill Insert Holders

C Series

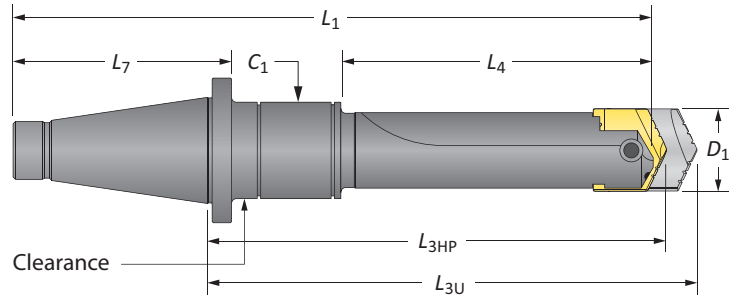



50 NMTB Shank*

Length	D ₁	Holder				Shank					Part No.
		L _{3HP}	L _{3U}	L ₄	L ₁	NMTB	L ₇	C ₁	RCA	Style	
Short	1-1/2 - 2-3/8	5-27/64	6-1/8	4	10-1/8	50	5-5/8	-	-	#300	22431-0050
Short	1-1/2 - 2-3/8	7-7/64	7-13/16	4	11-13/16	50	5-5/8	3/8	2T-5SR	#400	22631-0050
Short	1-1/2 - 2-3/8	11-39/64	12-5/16	8-1/2	16-5/16	50	5-5/8	3/8	2T-5SR	#500	22831-0050

*All NMTB shank holders are discontinued items. Items listed are available (subject to prior sale) at list prices until stock is depleted. Once stock is depleted, items are available as quoted specials only.

Rotary Coolant Adapter (RCA) and Accessories

ID	OD	L ₁	Driving Rod Thread	P ₁	RCA O-Rings		
					Part No.*	Kit Part No.**	Replacements
1-1/4	2-1/2	1-3/8	3/8 - NC	1/4	 2T-4SR	2T1-4SR	2T1-4OR-10
1-3/4	3	1-3/8	3/8 - NC	1/4	 2T-5SR	2T1-5SR	2T1-5OR-10

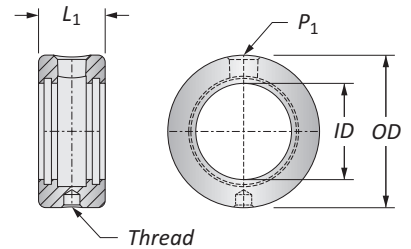



*RCA comes complete with (1) RCA, (2) O-rings, (2) snap rings, and (2) thrust washers



**RCA Repair Kit includes (2) O-rings, (2) snap rings, and (2) thrust washers

 Refer to page A40: 40 for proper RCA assembly and safety information

Connection Accessories

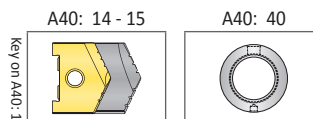
	
Clamping Screw	Blade-Loc Screw
1/4"-20 x 1	-



 = Imperial (in)
 = Metric (mm)
 O-rings sold in packs of 10

 **WARNING** RCA rotation during drilling can cause hose and/or hose fitting failure, machinery damage, and/or serious injury. To prevent, use RCA and positive stop studs when drilling. Factory technical assistance is also available for your specific applications.



High Performance Spade Drill Inserts

D Series | Diameter Range: 2.0000" - 2.8750"

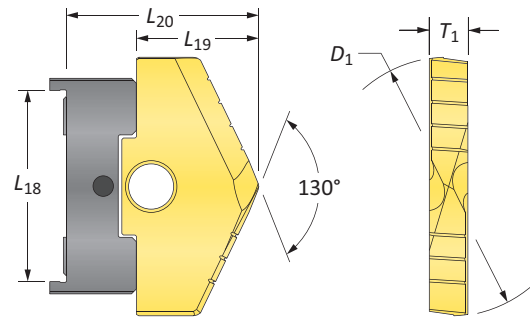
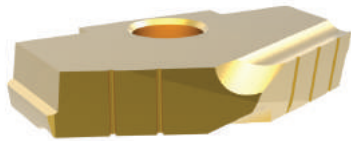

Series	D ₁ inch		Insert				TiN Part No.	TiAlN Part No.	TiCN Part No.	Adapter
	Fraction	Decimal	L ₁₈	L ₁₉	L ₂₀	T ₁				
D	2	2.0000	1-3/4	1-3/16	1-55/64	3/8	1024T-0200	1024A-0200	1024N-0200	1024U-Adapter
	2-1/32	2.0313	1-3/4	1-3/16	1-55/64	3/8	1024T-0201	1024A-0201	1024N-0201	1024U-Adapter
	2-1/16	2.0625	1-3/4	1-3/16	1-55/64	3/8	1024T-0202	1024A-0202	1024N-0202	1024U-Adapter
	2-3/32	2.0938	1-3/4	1-3/16	1-55/64	3/8	1024T-0203	1024A-0203	1024N-0203	1024U-Adapter
	2-1/8	2.1250	1-3/4	1-3/16	1-55/64	3/8	1024T-0204	1024A-0204	1024N-0204	1024U-Adapter
	2-5/32	2.1563	1-3/4	1-3/16	1-55/64	3/8	1024T-0205	1024A-0205	1024N-0205	1024U-Adapter
	2-3/16	2.1875	1-3/4	1-3/16	1-55/64	3/8	1024T-0206	1024A-0206	1024N-0206	1024U-Adapter
	2-7/32	2.2188	1-3/4	1-3/16	1-55/64	3/8	1024T-0207	1024A-0207	1024N-0207	1024U-Adapter
	2-1/4	2.2500	1-3/4	1-3/16	1-55/64	3/8	1024T-0208	1024A-0208	1024N-0208	1024U-Adapter
	2-9/32	2.2813	1-3/4	1-3/16	1-55/64	3/8	1024T-0209	1024A-0209	1024N-0209	1024U-Adapter
	2-5/16	2.3125	1-3/4	1-3/16	1-55/64	3/8	1024T-0210	1024A-0210	1024N-0210	1024U-Adapter
	2-11/32	2.3438	1-3/4	1-3/16	1-55/64	3/8	1024T-0211	1024A-0211	1024N-0211	1024U-Adapter
	2-3/8	2.3750	1-3/4	1-3/16	1-55/64	3/8	1024T-0212	1024A-0212	1024N-0212	1024U-Adapter
	2-13/32	2.4063	1-3/4	1-3/16	1-55/64	3/8	1024T-0213	1024A-0213	1024N-0213	1024U-Adapter
	2-7/16	2.4375	1-3/4	1-3/16	1-55/64	3/8	1024T-0214	1024A-0214	1024N-0214	1024U-Adapter
	2-15/32	2.4688	1-3/4	1-3/16	1-55/64	3/8	1024T-0215	1024A-0215	1024N-0215	1024U-Adapter
2-1/2	2.5000	1-3/4	1-3/16	1-55/64	3/8	1024T-0216	1024A-0216	1024N-0216	1024U-Adapter	
D Oversize	2-17/32	2.5313	1-3/4	1-3/16	1-55/64	3/8	1024T-0217	1024A-0217	1024N-0217	1024U-Adapter
	2-9/16	2.5625	1-3/4	1-3/16	1-55/64	3/8	1024T-0218	1024A-0218	1024N-0218	1024U-Adapter
	2-19/32	2.5938	1-3/4	1-3/16	1-55/64	3/8	1024T-0219	1024A-0219	1024N-0219	1024U-Adapter
	2-5/8	2.6250	1-3/4	1-3/16	1-55/64	3/8	1024T-0220	1024A-0220	1024N-0220	1024U-Adapter
	2-21/32	2.6563	1-3/4	1-3/16	1-55/64	3/8	1024T-0221	1024A-0221	1024N-0221	1024U-Adapter
	2-11/16	2.6875	1-3/4	1-3/16	1-55/64	3/8	1024T-0222	1024A-0222	1024N-0222	1024U-Adapter
	2-23/32	6.7188	1-3/4	1-3/16	1-55/64	3/8	1024T-0223	1024A-0223	1024N-0223	1024U-Adapter
	2-3/4	6.7500	1-3/4	1-3/16	1-55/64	3/8	1024T-0224	1024A-0224	1024N-0224	1024U-Adapter
	2-25/35	6.7813	1-3/4	1-3/16	1-55/64	3/8	1024T-0225	1024A-0225	1024N-0225	1024U-Adapter
	2-13/16	2.8125	1-3/4	1-3/16	1-55/64	3/8	1024T-0226	1024A-0226	1024N-0226	1024U-Adapter
	2-27/32	2.8438	1-3/4	1-3/16	1-55/64	3/8	1024T-0227	1024A-0227	1024N-0227	1024U-Adapter
	2-7/8	2.8750	1-3/4	1-3/16	1-55/64	3/8	1024T-0228	1024A-0228	1024N-0228	1024U-Adapter

NOTE: Adapter is required for D-H series High Performance spade drills. Adapters sold separately.

Inserts sold in multiples of 1

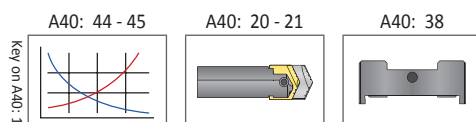

Sizes not shown are available upon request.

When ordering, please follow the example below:

Inch:	7-63/64", 130° CPM-M4 (H8 series) = use Part No. 10294-7.9843
Decimal:	6.391", 130° CPM-M4 (H5 series) = use Part No. 10294-6.3910



Universal Spade Drill Inserts

D Series | Diameter Range: 2.0000" - 2.8750"

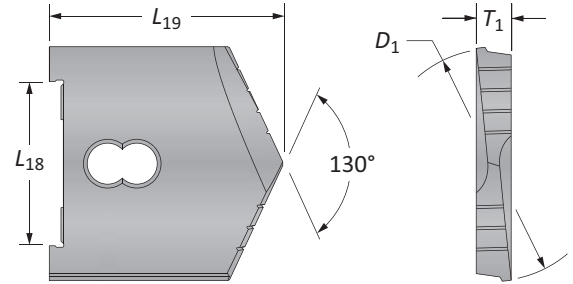
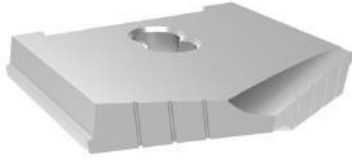

Series	D ₁ inch		Insert						
	Fraction	Decimal	L ₁₈	L ₁₉	T ₁	130° CPM-M4	130° CPM-T15*	Flat Bottom	90° Spot & Chamfer
D	2	2.0000	1-3/4	2-3/8	3/8	10244-0200	-	10444-0200	POR
	2-1/32	2.0313	1-3/4	2-3/8	3/8	10244-0201	-	-	POR
	2-1/16	2.0625	1-3/4	2-3/8	3/8	10244-0202	10245-0202	10444-0202	POR
	2-3/32	2.0938	1-3/4	2-3/8	3/8	10244-0203	-	-	POR
	2-1/8	2.1250	1-3/4	2-3/8	3/8	10244-0204	-	10444-0204	POR
	2-5/32	2.1563	1-3/4	2-3/8	3/8	10244-0205	-	-	POR
	2-3/16	2.1875	1-3/4	2-3/8	3/8	10244-0206	10245-0206	10444-0206	POR
	2-7/32	2.2188	1-3/4	2-3/8	3/8	10244-0207	-	-	POR
	2-1/4	2.2500	1-3/4	2-3/8	3/8	10244-0208	-	10444-0208	POR
	2-9/32	2.2813	1-3/4	2-3/8	3/8	10244-0209	-	-	POR
	2-5/16	2.3125	1-3/4	2-3/8	3/8	10244-0210	10245-0210	10444-0210	POR
	2-11/32	2.3438	1-3/4	2-3/8	3/8	10244-0211	-	-	POR
	2-3/8	2.3750	1-3/4	2-3/8	3/8	10244-0212	-	10444-0212	POR
	2-13/32	2.4063	1-3/4	2-3/8	3/8	10244-0213	-	-	POR
	2-7/16	2.4375	1-3/4	2-3/8	3/8	10244-0214	10245-0214	10444-0214	POR
	2-15/32	2.4688	1-3/4	2-3/8	3/8	10244-0215	-	-	POR
2-1/2	2.5000	1-3/4	2-3/8	3/8	10244-0216	-	10444-0216	11244-0216	
D Oversize	2-17/32	2.5313	1-3/4	2-3/8	3/8	10244-0217	-	-	-
	2-9/16	2.5625	1-3/4	2-3/8	3/8	10244-0218	-	-	-
	2-19/32	2.5938	1-3/4	2-3/8	3/8	10244-0219	-	-	-
	2-5/8	2.6250	1-3/4	2-3/8	3/8	10244-0220	-	-	-
	2-21/32	2.6563	1-3/4	2-3/8	3/8	10244-0221	-	-	-
	2-11/16	2.6875	1-3/4	2-3/8	3/8	10244-0222	-	-	-
	2-23/32	2.7188	1-3/4	2-3/8	3/8	10244-0223	-	-	-
	2-3/4	2.7500	1-3/4	2-3/8	3/8	10244-0224	-	-	-
	2-25/32	2.7813	1-3/4	2-3/8	3/8	10244-0225	-	-	-
	2-13/16	2.8125	1-3/4	2-3/8	3/8	10244-0226	-	-	-
	2-27/32	2.8438	1-3/4	2-3/8	3/8	10244-0227	-	-	-
	2-7/8	2.8750	1-3/4	2-3/8	3/8	10244-0228	-	-	-

*Discontinued | NOTE: POR = Priced on request

Flat Bottom

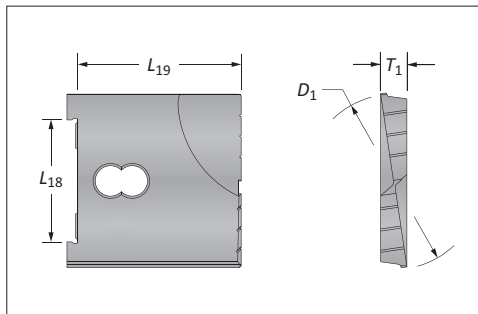

90° Spot & Chamfer

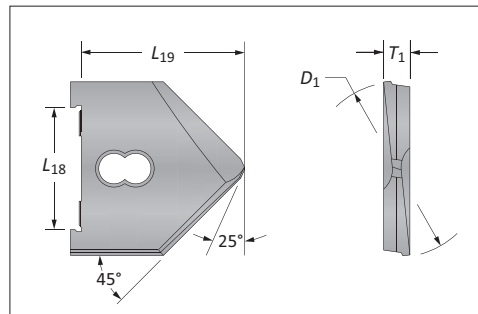

A40: 44 - 45

A40: 20 - 21

A40: 2

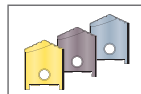
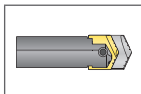
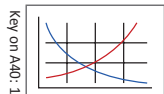

Sizes not shown are available upon request.
When ordering, please follow the example below:

Inch:	1-17/64", 130° CPM-M4 (B series) = use Part No. 10224-1.2656
Decimal:	1.5110", 130° Flat Bottom (C series) = use Part No. 10434-1.5110



High Performance / Universal Spade Drill Insert Holders

D Series

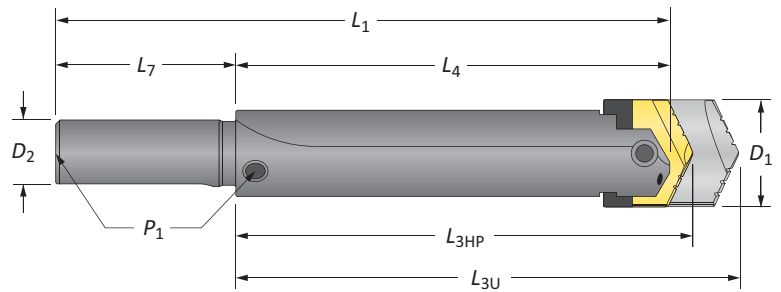

Straight Shank

Length	D ₁	Holder				Shank				Style	Part No.
		L _{3HP}	L _{3U}	L ₄	L ₁	D ₂	L ₇	P ₁			
Stub	2 - 2-7/8	2-19/64	3	2	6	1-1/2	4	-	#125	20241-1500	
Short	2 - 2-7/8	4-63/64	5-1/2	4-1/2	8-1/2	1-1/2	4	-	#150	20441-1500	
Short	2 - 2-7/8	4-63/64	5-1/2	4-1/2	8-1/2	1-1/2	4	1/4	#100	20641-1500	
Standard	2 - 2-7/8	9-31/64	10	9	13	1-1/2	4	1/4	#200	20841-1500	
Long	2 - 2-7/8	18-31/64	19	18	22	1-1/2	4	1/4	#250	21041-1500	

NOTE: Adapter is required for D-H series High Performance spade drills. Adapters sold separately.

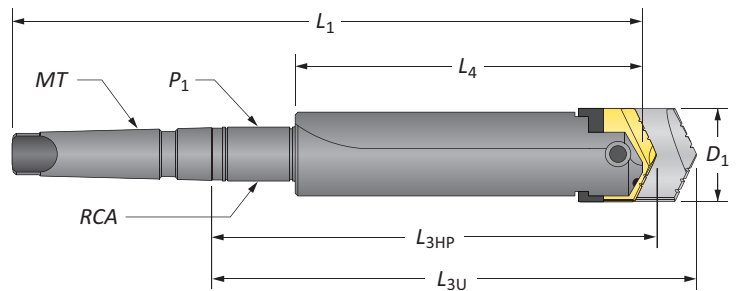

Taper Shank

Length	D ₁	Holder				Shank				Style	Part No.
		L _{3HP}	L _{3U}	L ₄	L ₁	MT	P ₁	RCA			
Short	2 - 2-7/8	5-15/64	5-3/4	4-1/2	9-3/8	#4	-	-	#300	21441-0004	
Short	2 - 2-7/8	5-15/64	5-3/4	4-1/2	10-5/8	#5	-	-	#300	21441-0005	
Short	2 - 2-7/8	5-15/64	5-3/4	4-1/2	9-3/8	#4	-	-	#300 TSC	21541-0004*	
Short	2 - 2-7/8	6-59/64	7-7/16	4-1/2	11-1/16	#4	1/4	2T-4SR	#400 SR	21641-0004	
Standard	2 - 2-7/8	11-27/64	11-15/16	9	15-9/16	#4	1/4	2T-4SR	#500 SR	21841-0004	
Standard	2 - 2-7/8	11-27/64	11-15/16	9	16-13/16	#5	1/4	2T-5SR	#500 SR	21841-0005	
Long	2 - 2-7/8	20-27/64	20-15/16	18	24-9/16	#4	1/4	2T-4SR	#600 SR	22041-0004	
Long	2 - 2-7/8	20-27/64	20-15/16	18	25-13/16	#5	1/4	2T-5SR	#600 SR	22041-0005	
XL	2 - 2-7/8	30-27/64	30-15/16	28	34-9/16	#4	1/4	2T-4SR	#700 SR	22241-0004	
XL	2 - 2-7/8	30-27/64	30-15/16	28	35-13/16	#5	1/4	2T-5SR	#700 SR	22241-0005	

*Through shank coolant, coolant inlet diameter = 5/16"

NOTE: Adapter is required for D-H series High Performance spade drills. Adapters sold separately.

Connection Accessories

Clamping Screw	Blade-Loc Screw
3/8"-16 x 1-1/4"	5/16"-18 x 1/2"

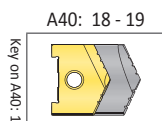

i = Imperial (in)
m = Metric (mm)

WARNING Refer to Speed and Feed charts for recommended adjustments to speeds and feeds. Refer to page A40: 48 for deep hole drilling guidelines in this section of the catalog. Visit www.alliedmachine.com/DeepHoleGuidelines for the most up-to-date information and procedures. Factory technical assistance is available for your specific applications through our Application Engineering Team.

High Performance / Universal Spade Drill Insert Holders

D Series

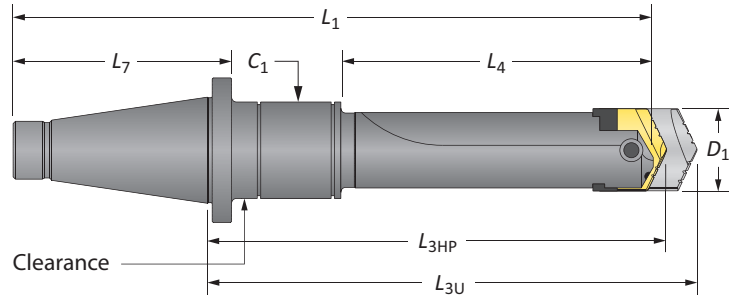

50 NMTB Shank*

Length	D ₁	Holder				Shank					Part No.
		L _{3HP}	L _{3U}	L ₄	L ₁	NMTB	L ₇	C ₁	RCA	Style	
i Short	2 - 2-7/8	9-27/64	9-15/16	5-1/2	13-15/16	50	5-5/8	3/8	2T-55SR	#400	22641-0050
Short	2 - 2-7/8	15-27/64	15-15/16	11-1/2	19-15/16	50	5-5/8	3/8	2T-55SR	#500	22841-0050

*All NMTB shank holders are discontinued items. Items listed are available (subject to prior sale) at list prices until stock is depleted. Once stock is depleted, items are available as quoted specials only.

Rotary Coolant Adapter (RCA) and Accessories

ID	OD	L ₁	Driving Rod Thread	P ₁	Part No.*	RCA O-Rings	
						Kit Part No.**	Replacements
i 1-1/4	2-1/2	1-3/8	3/8 - NC	1/4	⚠ 2T-4SR	2T1-4SR	2T1-4OR-10
1-3/4	3	1-3/8	3/8 - NC	1/4	⚠ 2T-5SR	2T1-5SR	2T1-5OR-10
2-1/2	4	1-3/4	1/2 - NC	1/2	⚠ 2T-55SR	2T1-55SR	2T1-55OR-10

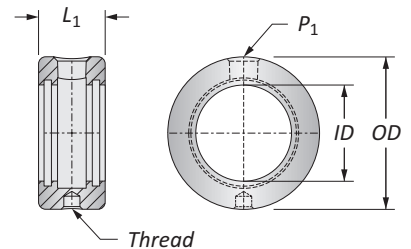



*RCA comes complete with (1) RCA, (2) O-rings, (2) snap rings, and (2) thrust washers

**RCA Repair Kit includes (2) O-rings, (2) snap rings, and (2) thrust washers

⚠ Refer to page A40: 40 for proper RCA assembly and safety information

Connection Accessories

	
Clamping Screw	Blade-Loc Screw
3/8"-16 x 1-1/4"	5/16"-18 x 1/2"

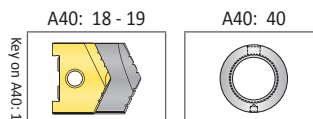

i = Imperial (in)
m = Metric (mm)
 O-rings sold in packs of 10

⚠ WARNING RCA rotation during drilling can cause hose and/or hose fitting failure, machinery damage, and/or serious injury. To prevent, use RCA and positive stop studs when drilling. Factory technical assistance is also available for your specific applications.

High Performance Spade Drill Inserts

E Series | Diameter Range: 2.5000" - 3.3750"

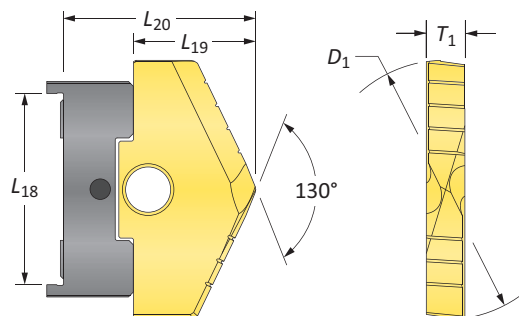
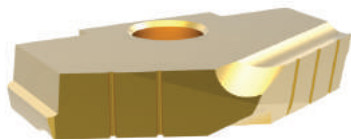

Series	D ₁ inch		Inserts				TiN Part No.	TiAlN Part No.	TiCN Part No.	Adapter
	Fraction	Decimal	L ₁₈	L ₁₉	L ₂₀	T ₁				
E	2-1/2	2.5000	2-1/16	1-7/16	2-3/32	7/16	1025T-0216	1025A-0216	1025N-0216	1025U-Adapter
	2-17/32	2.5313	2-1/16	1-7/16	2-3/32	7/16	1025T-0217	1025A-0217	1025N-0217	1025U-Adapter
	2-9/16	2.5625	2-1/16	1-7/16	2-3/32	7/16	1025T-0218	1025A-0218	1025N-0218	1025U-Adapter
	2-19/32	2.5938	2-1/16	1-7/16	2-3/32	7/16	1025T-0219	1025A-0219	1025N-0219	1025U-Adapter
	2-5/8	2.6250	2-1/16	1-7/16	2-3/32	7/16	1025T-0220	1025A-0220	1025N-0220	1025U-Adapter
	2-21/32	2.6563	2-1/16	1-7/16	2-3/32	7/16	1025T-0221	1025A-0221	1025N-0221	1025U-Adapter
	2-11/16	2.6875	2-1/16	1-7/16	2-3/32	7/16	1025T-0222	1025A-0222	1025N-0222	1025U-Adapter
	2-23/32	2.7188	2-1/16	1-7/16	2-3/32	7/16	1025T-0223	1025A-0223	1025N-0223	1025U-Adapter
	2-3/4	2.7500	2-1/16	1-7/16	2-3/32	7/16	1025T-0224	1025A-0224	1025N-0224	1025U-Adapter
	2-25/32	2.7813	2-1/16	1-7/16	2-3/32	7/16	1025T-0225	1025A-0225	1025N-0225	1025U-Adapter
	2-13/16	2.8125	2-1/16	1-7/16	2-3/32	7/16	1025T-0226	1025A-0226	1025N-0226	1025U-Adapter
	2-27/32	2.8438	2-1/16	1-7/16	2-3/32	7/16	1025T-0227	1025A-0227	1025N-0227	1025U-Adapter
	2-7/8	2.8750	2-1/16	1-7/16	2-3/32	7/16	1025T-0228	1025A-0228	1025N-0228	1025U-Adapter
	2-29/32	2.9063	2-1/16	1-7/16	2-3/32	7/16	1025T-0229	1025A-0229	1025N-0229	1025U-Adapter
	2-15/16	2.9375	2-1/16	1-7/16	2-3/32	7/16	1025T-0230	1025A-0230	1025N-0230	1025U-Adapter
2-31/32	2.9688	2-1/16	1-7/16	2-3/32	7/16	1025T-0231	1025A-0231	1025N-0231	1025U-Adapter	
3	3.0000	2-1/16	1-7/16	2-3/32	7/16	1025T-0300	1025A-0300	1025N-0300	1025U-Adapter	
E Oversize	3-1/32	3.0313	2-1/16	1-7/16	2-3/32	7/16	1025T-0301	1025A-0301	1025N-0301	1025U-Adapter
	3-1/16	3.0625	2-1/16	1-7/16	2-3/32	7/16	1025T-0302	1025A-0302	1025N-0302	1025U-Adapter
	3-3/32	3.0938	2-1/16	1-7/16	2-3/32	7/16	1025T-0303	1025A-0303	1025N-0303	1025U-Adapter
	3-1/8	3.1250	2-1/16	1-7/16	2-3/32	7/16	1025T-0304	1025A-0304	1025N-0304	1025U-Adapter
	3-5/32	3.1563	2-1/16	1-7/16	2-3/32	7/16	1025T-0305	1025A-0305	1025N-0305	1025U-Adapter
	3-3/16	3.1875	2-1/16	1-7/16	2-3/32	7/16	1025T-0306	1025A-0306	1025N-0306	1025U-Adapter
	3-7/32	3.2188	2-1/16	1-7/16	2-3/32	7/16	1025T-0307	1025A-0307	1025N-0307	1025U-Adapter
	3-1/4	3.2500	2-1/16	1-7/16	2-3/32	7/16	1025T-0308	1025A-0308	1025N-0308	1025U-Adapter
	3-9/32	3.2813	2-1/16	1-7/16	2-3/32	7/16	1025T-0309	1025A-0309	1025N-0309	1025U-Adapter
	3-5/16	3.3125	2-1/16	1-7/16	2-3/32	7/16	1025T-0310	1025A-0310	1025N-0310	1025U-Adapter
	3-11/32	3.3438	2-1/16	1-7/16	2-3/32	7/16	1025T-0311	1025A-0311	1025N-0311	1025U-Adapter
	3-3/8	3.3750	2-1/16	1-7/16	2-3/32	7/16	1025T-0312	1025A-0312	1025N-0312	1025U-Adapter

NOTE: Adapter is required for D-H series High Performance spade drills. Adapters sold separately.

Inserts sold in multiples of 1

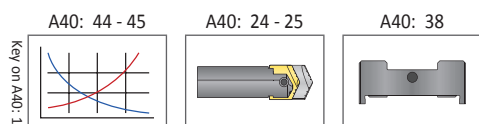

Sizes not shown are available upon request.

When ordering, please follow the example below:

Inch:	7-63/64", 130° CPM-M4 (H8 series) = use Part No. 10294-7.9843
Decimal:	6.391", 130° CPM-M4 (H5 series) = use Part No. 10294-6.3910



Universal Spade Drill Inserts

E Series | Diameter Range: 2.5000" - 3.3750"

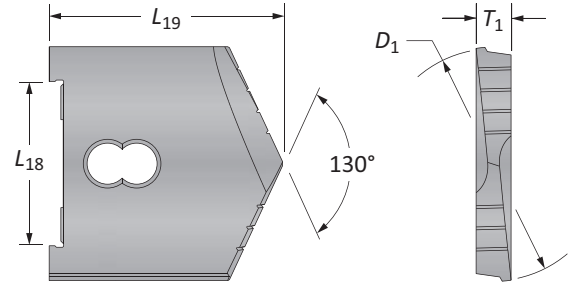

Series	D ₁ inch		Inserts						
	Fraction	Decimal	L ₁₈	L ₁₉	T ₁	130° CPM-M4	130° CPM-T15*	Flat Bottom	90° Spot & Chamfer
E	2-1/2	2.5000	2-1/16	2-5/8	7/16	10254-0216	10255-0216	10454-0216	POR
	2-17/32	2.5313	2-1/16	2-5/8	7/16	10254-0217	-	-	POR
	2-9/16	2.5625	2-1/16	2-5/8	7/16	10254-0218	10255-0218	10454-0218	POR
	2-19/32	2.5938	2-1/16	2-5/8	7/16	10254-0219	-	-	POR
	2-5/8	2.6250	2-1/16	2-5/8	7/16	10254-0220	10255-0220	10454-0220	POR
	2-21/32	2.6563	2-1/16	2-5/8	7/16	10254-0221	-	-	POR
	2-11/16	2.6875	2-1/16	2-5/8	7/16	10254-0222	10255-0222	10454-0222	POR
	2-23/32	2.7188	2-1/16	2-5/8	7/16	10254-0223	-	-	POR
	2-3/4	2.7500	2-1/16	2-5/8	7/16	10254-0224	10255-0224	10454-0224	POR
	2-25/32	2.7813	2-1/16	2-5/8	7/16	10254-0225	-	-	POR
	2-13/16	2.8125	2-1/16	2-5/8	7/16	10254-0226	10255-0226	10454-0226	POR
	2-27/32	2.8438	2-1/16	2-5/8	7/16	10254-0227	-	-	POR
	2-7/8	2.8750	2-1/16	2-5/8	7/16	10254-0228	10255-0228	10454-0228	POR
	2-29/32	2.9063	2-1/16	2-5/8	7/16	10254-0229	-	-	POR
	2-15/16	2.9375	2-1/16	2-5/8	7/16	10254-0230	10255-0230	10454-0230	POR
	2-31/32	2.9688	2-1/16	2-5/8	7/16	10254-0231	-	-	POR
3	3.0000	2-1/16	2-5/8	7/16	10254-0300	10255-0300	10454-0300	11254-0300	
E Oversize	3-1/32	3.0313	2-1/16	2-5/8	7/16	10254-0301	-	-	-
	3-1/16	3.0625	2-1/16	2-5/8	7/16	10254-0302	-	-	-
	3-3/32	3.0938	2-1/16	2-5/8	7/16	10254-0303	-	-	-
	3-1/8	3.1250	2-1/16	2-5/8	7/16	10254-0304	-	-	-
	3-5/32	3.1563	2-1/16	2-5/8	7/16	10254-0305	-	-	-
	3-3/16	3.1875	2-1/16	2-5/8	7/16	10254-0306	-	-	-
	3-7/32	3.2188	2-1/16	2-5/8	7/16	10254-0307	-	-	-
	3-1/4	3.2500	2-1/16	2-5/8	7/16	10254-0308	-	-	-
	3-9/32	3.2813	2-1/16	2-5/8	7/16	10254-0309	-	-	-
	3-5/16	3.3125	2-1/16	2-5/8	7/16	10254-0310	-	-	-
	3-11/32	3.3438	2-1/16	2-5/8	7/16	10254-0311	-	-	-
	3-3/8	3.3750	2-1/16	2-5/8	7/16	10254-0312	-	-	-

*Discontinued | NOTE: POR = Priced on request

Flat Bottom

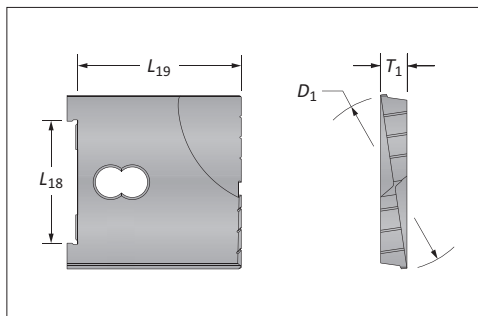

90° Spot & Chamfer

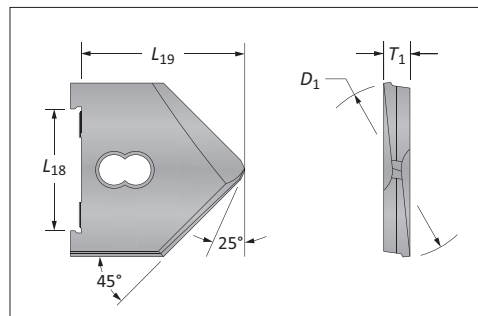

A40: 44 - 45

A40: 24 - 25

A40: 2

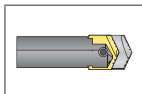
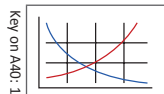

Sizes not shown are available upon request.
When ordering, please follow the example below:

Inch:	1-17/64", 130° CPM-M4 (B series) = use Part No. 10224-1.2656
Decimal:	1.5110", 130° Flat Bottom (C series) = use Part No. 10434-1.5110

High Performance / Universal Spade Drill Insert Holders

E Series

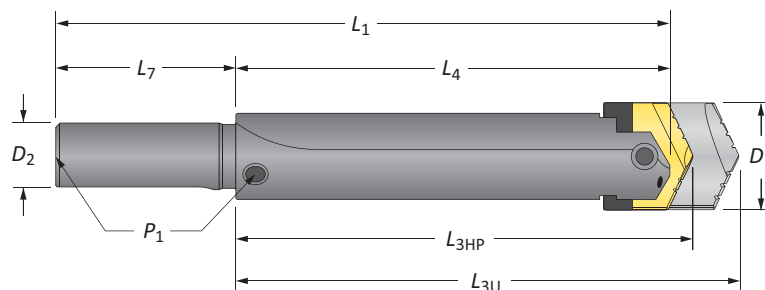

Straight Shank

Length	D_1	Insert				Shank				Part No.
		L_{3HP}	L_{3U}	L_4	L_1	D_2	L_7	P_1	Style	
Stub	2-1/2 - 3-3/8	3-1/32	3-9/16	2-1/2	6-1/2	2	4	–	#125	20251-2000
Short	2-1/2 - 3-3/8	5-17/32	6-1/16	5	9	1-3/4	4	–	#150	20451-1750
i Short	2-1/2 - 3-3/8	5-17/32	6-1/16	5	9	1-3/4	4	1/2	#100	20651-1750
Standard	2-1/2 - 3-3/8	10-17/32	11-1/16	10	14	2	4	1/2	#200	20851-2000
Long	2-1/2 - 3-3/8	20-17/32	21-1/16	20	24	2	4	1/2	#250	21051-2000

NOTE: Adapter is required for D-H series High Performance spade drills. Adapters sold separately.

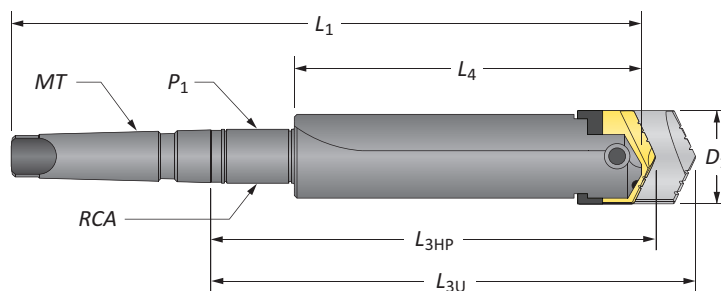

Taper Shank

Length	D_1	Holder				Shank				Part No.
		L_{3HP}	L_{3U}	L_4	L_1	MT	P_1	RCA	Style	
Short	2-1/2 - 3-3/8	5-25/32	6-5/16	5	9-7/8	#4	–	–	#300	21451-0004
Short	2-1/2 - 3-3/8	5-25/32	6-5/16	5	11-1/8	#5	–	–	#300	21451-0005
Short	2-1/2 - 3-3/8	5-25/32	6-5/16	5	11-1/8	#5	–	–	#300 TSC	21551-0005*
i Short	2-1/2 - 3-3/8	8-3/32	8-5/8	5	13-7/16	#5	1/2	2T-6SR	#400 SR	21651-0005
Standard	2-1/2 - 3-3/8	13-3/32	13-5/8	10	18-7/16	#5	1/2	2T-6SR	#500 SR	21851-0005
Long	2-1/2 - 3-3/8	23-3/32	23-5/8	20	28-7/16	#5	1/2	2T-6SR	#600 SR	22051-0005
XL	2-1/2 - 3-3/8	33-3/32	33-5/8	30	38-7/16	#5	1/2	2T-6SR	#700 SR	22251-0005

*Through shank coolant, coolant inlet diameter = 3/8"

NOTE: Adapter is required for D-H series High Performance spade drills. Adapters sold separately.

Connection Accessories

<p>Clamping Screw 1/2"-13 x 1-3/4"</p>	<p>Blade-Loc Screw 5/16"-18 x 1/2"</p>
---	---

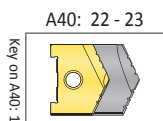

i = Imperial (in)
m = Metric (mm)

WARNING Refer to Speed and Feed charts for recommended adjustments to speeds and feeds. Refer to page A40: 48 for deep hole drilling guidelines in this section of the catalog. Visit www.alliedmachine.com/DeepHoleGuidelines for the most up-to-date information and procedures. Factory technical assistance is available for your specific applications through our Application Engineering Team.

High Performance / Universal Spade Drill Insert Holders

E Series

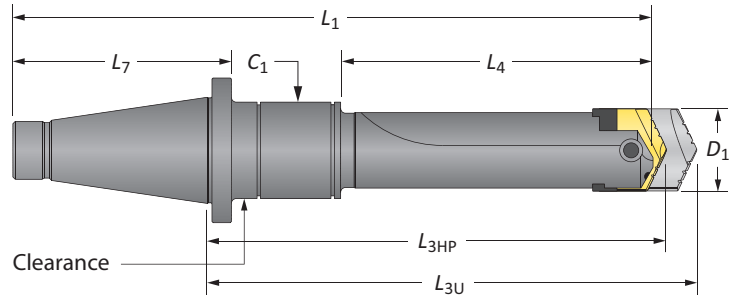

50 NMTB Shank*

Length	D ₁	Holders				Shank					Part No.
		L _{3HP}	L _{3U}	L ₄	L ₁	NMTB	L ₇	C ₁	RCA	Style	
Short	2-1/2 - 3-3/8	9-15/32	10	5-1/2	13-15/16	50	5-5/8	5/8	2T-55SR	#400	22651-0050
	2-1/2 - 3-3/8	15-15/32	16	11-1/2	19-15/16	50	5-5/8	5/8	2T-55SR	#500	22851-0050

*All NMTB shank holders are discontinued items. Items listed are available (subject to prior sale) at list prices until stock is depleted. Once stock is depleted, items are available as quoted specials only.

Rotary Coolant Adapter (RCA) and Accessories

ID	OD	L ₁	Driving Rod Thread	P ₁	Part No.*	RCA O-Rings	
						Kit Part No.**	Replacements
2-1/4	3-3/4	1-3/4	1/2 - NC	1/2	▲ 2T-6SR	2T1-6SR	2T1-6OR-10
							2T1-55SR
2-1/2	4	1-3/4	1/2 - NC	1/2	▲ 2T-55SR	2T1-55SR	2T1-55OR-10

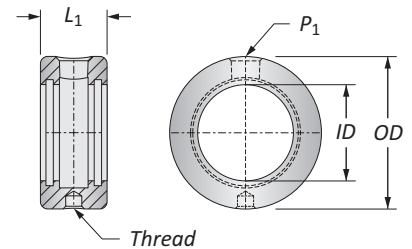



*RCA comes complete with (1) RCA, (2) O-rings, (2) snap rings, and (2) thrust washers

**RCA Repair Kit includes (2) O-rings, (2) snap rings, and (2) thrust washers

▲ Refer to page A40: 40 for proper RCA assembly and safety information

Connection Accessories

	
Clamping Screw	Blade-Loc Screw
1/2"-13 x 1-3/4"	5/16"-18 x 1/2"

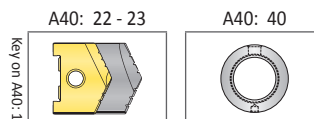

ⓘ = Imperial (in)
 ⓘ = Metric (mm)
 O-rings sold in packs of 10

WARNING RCA rotation during drilling can cause hose and/or hose fitting failure, machinery damage, and/or serious injury. To prevent, use RCA and positive stop studs when drilling. Factory technical assistance is also available for your specific applications.

High Performance Spade Drill Inserts

F Series | Diameter Range: 3.0000" - 3.8750"

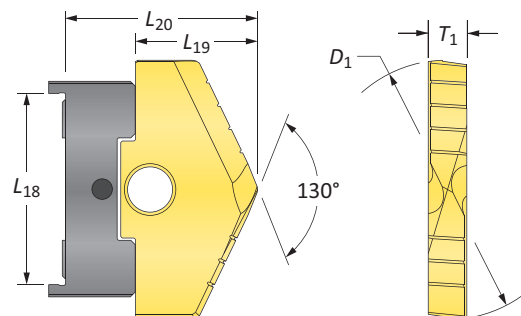
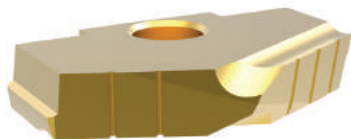

Series	D ₁ inch		Insert				TiN Part No.	TiAlN Part No.	TiCN Part No.	Adapter
	Fraction	Decimal	L ₁₈	L ₁₉	L ₂₀	T ₁				
F	3	3.0000	2-5/8	1-13/16	2-17/32	1/2	1026T-0300	1026A-0300	1026N-0300	1026U-Adapter
	3-1/32	3.0313	2-5/8	1-13/16	2-17/32	1/2	1026T-0301	1026A-0301	1026N-0301	1026U-Adapter
	3-1/16	3.0625	2-5/8	1-13/16	2-17/32	1/2	1026T-0302	1026A-0302	1026N-0302	1026U-Adapter
	3-3/32	3.0938	2-5/8	1-13/16	2-17/32	1/2	1026T-0303	1026A-0303	1026N-0303	1026U-Adapter
	3-1/8	3.1250	2-5/8	1-13/16	2-17/32	1/2	1026T-0304	1026A-0304	1026N-0304	1026U-Adapter
	3-5/32	3.1563	2-5/8	1-13/16	2-17/32	1/2	1026T-0305	1026A-0305	1026N-0305	1026U-Adapter
	3-3/16	3.1875	2-5/8	1-13/16	2-17/32	1/2	1026T-0306	1026A-0306	1026N-0306	1026U-Adapter
	3-7/32	3.2188	2-5/8	1-13/16	2-17/32	1/2	1026T-0307	1026A-0307	1026N-0307	1026U-Adapter
	3-1/4	3.2500	2-5/8	1-13/16	2-17/32	1/2	1026T-0308	1026A-0308	1026N-0308	1026U-Adapter
	3-9/32	3.2813	2-5/8	1-13/16	2-17/32	1/2	1026T-0309	1026A-0309	1026N-0309	1026U-Adapter
	3-5/16	3.3125	2-5/8	1-13/16	2-17/32	1/2	1026T-0310	1026A-0310	1026N-0310	1026U-Adapter
	3-11/32	3.3438	2-5/8	1-13/16	2-17/32	1/2	1026T-0311	1026A-0311	1026N-0311	1026U-Adapter
	3-3/8	3.3750	2-5/8	1-13/16	2-17/32	1/2	1026T-0312	1026A-0312	1026N-0312	1026U-Adapter
	3-13/32	3.4063	2-5/8	1-13/16	2-17/32	1/2	1026T-0313	1026A-0313	1026N-0313	1026U-Adapter
	3-7/16	3.4375	2-5/8	1-13/16	2-17/32	1/2	1026T-0314	1026A-0314	1026N-0314	1026U-Adapter
	3-15/32	3.4688	2-5/8	1-13/16	2-17/32	1/2	1026T-0315	1026A-0315	1026N-0315	1026U-Adapter
3-1/2	3.5000	2-5/8	1-13/16	2-17/32	1/2	1026T-0316	1026A-0316	1026N-0316	1026U-Adapter	
F Oversize	3-17/32	3.5313	2-5/8	1-13/16	2-17/32	1/2	1026T-0317	1026A-0317	1026N-0317	1026U-Adapter
	3-9/16	3.5625	2-5/8	1-13/16	2-17/32	1/2	1026T-0318	1026A-0318	1026N-0318	1026U-Adapter
	3-19/32	3.5938	2-5/8	1-13/16	2-17/32	1/2	1026T-0319	1026A-0319	1026N-0319	1026U-Adapter
	3-5/8	3.6250	2-5/8	1-13/16	2-17/32	1/2	1026T-0320	1026A-0320	1026N-0320	1026U-Adapter
	3-21/32	3.6563	2-5/8	1-13/16	2-17/32	1/2	1026T-0321	1026A-0321	1026N-0321	1026U-Adapter
	3-11/16	3.6875	2-5/8	1-13/16	2-17/32	1/2	1026T-0322	1026A-0322	1026N-0322	1026U-Adapter
	3-23/32	3.7188	2-5/8	1-13/16	2-17/32	1/2	1026T-0323	1026A-0323	1026N-0323	1026U-Adapter
	3-3/4	3.7500	2-5/8	1-13/16	2-17/32	1/2	1026T-0324	1026A-0324	1026N-0324	1026U-Adapter
	3-25/32	3.7813	2-5/8	1-13/16	2-17/32	1/2	1026T-0325	1026A-0325	1026N-0325	1026U-Adapter
	3-13/16	3.8125	2-5/8	1-13/16	2-17/32	1/2	1026T-0326	1026A-0326	1026N-0326	1026U-Adapter
	3-27/32	3.8438	2-5/8	1-13/16	2-17/32	1/2	1026T-0327	1026A-0327	1026N-0327	1026U-Adapter
	3-7/8	3.8750	2-5/8	1-13/16	2-17/32	1/2	1026T-0328	1026A-0328	1026N-0328	1026U-Adapter

NOTE: Adapter is required for D-H series High Performance spade drills. Adapters sold separately.

Inserts sold in multiples of 1

A40: 44 - 45

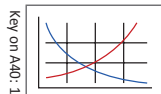

A40: 28 - 29

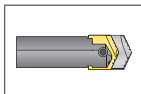

A40: 38

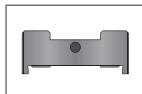

Sizes not shown are available upon request.

When ordering, please follow the example below:

Inch:	7-63/64", 130° CPM-M4 (H8 series) = use Part No. 10294-7.9843
Decimal:	6.391", 130° CPM-M4 (H5 series) = use Part No. 10294-6.3910



Universal Spade Drill Inserts

F Series | Diameter Range: 3.0000" - 3.8750"

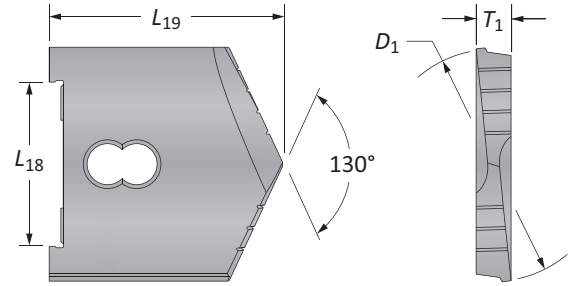

Series	D ₁ inch		Insert						
	Fraction	Decimal	L ₁₈	L ₁₉	T ₁	130° CPM-M4	130° CPM-T15*	Flat Bottom	90° Spot & Chamfer
F	3	3.0000	2-5/8	3-1/8	1/2	10264-0300	10265-0300	10464-0300	POR
	3-1/32	3.0313	2-5/8	3-1/8	1/2	10264-0301	-	-	POR
	3-1/16	3.0625	2-5/8	3-1/8	1/2	10264-0302	10265-0302	10464-0302	POR
	3-3/32	3.0938	2-5/8	3-1/8	1/2	10264-0303	-	-	POR
	3-1/8	3.1250	2-5/8	3-1/8	1/2	10264-0304	10265-0304	10464-0304	POR
	3-5/32	3.1563	2-5/8	3-1/8	1/2	10264-0305	-	-	POR
	3-3/16	3.1875	2-5/8	3-1/8	1/2	10264-0306	10265-0306	10464-0306	POR
	3-7/32	3.2188	2-5/8	3-1/8	1/2	10264-0307	-	-	POR
	3-1/4	3.2500	2-5/8	3-1/8	1/2	10264-0308	-	-	POR
	3-9/32	3.2813	2-5/8	3-1/8	1/2	10264-0309	-	-	POR
	3-5/16	3.3125	2-5/8	3-1/8	1/2	10264-0310	10265-0310	10464-0310	POR
	3-11/32	3.3438	2-5/8	3-1/8	1/2	10264-0311	-	-	POR
	3-3/8	3.3750	2-5/8	3-1/8	1/2	10264-0312	-	-	POR
	3-13/32	3.4063	2-5/8	3-1/8	1/2	10264-0313	-	-	POR
	3-7/16	3.4375	2-5/8	3-1/8	1/2	10264-0314	10265-0314	10464-0314	POR
	3-15/32	3.4688	2-5/8	3-1/8	1/2	10264-0315	-	-	POR
3-1/2	3.5000	2-5/8	3-1/8	1/2	10264-0316	-	10464-0316	11264-0316	
F Oversize	3-17/32	3.5313	2-5/8	3-1/8	1/2	10264-0317	-	-	-
	3-9/16	3.5625	2-5/8	3-1/8	1/2	10264-0318	-	-	-
	3-19/32	3.5938	2-5/8	3-1/8	1/2	10264-0319	-	-	-
	3-5/8	3.6250	2-5/8	3-1/8	1/2	10264-0320	-	-	-
	3-21/32	3.6563	2-5/8	3-1/8	1/2	10264-0321	-	-	-
	3-11/16	3.6875	2-5/8	3-1/8	1/2	10264-0322	-	-	-
	3-23/32	3.7188	2-5/8	3-1/8	1/2	10264-0323	-	-	-
	3-3/4	3.7500	2-5/8	3-1/8	1/2	10264-0324	-	-	-
	3-25/32	3.7813	2-5/8	3-1/8	1/2	10264-0325	-	-	-
	3-13/16	3.8125	2-5/8	3-1/8	1/2	10264-0326	-	-	-
	3-27/32	3.8438	2-5/8	3-1/8	1/2	10264-0327	-	-	-
	3-7/8	3.8750	2-5/8	3-1/8	1/2	10264-0328	-	-	-

*Discontinued | NOTE: POR = Priced on request

Flat Bottom

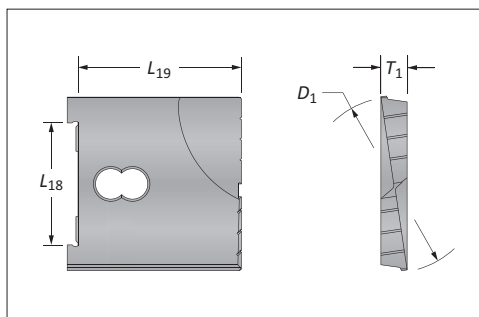

90° Spot & Chamfer

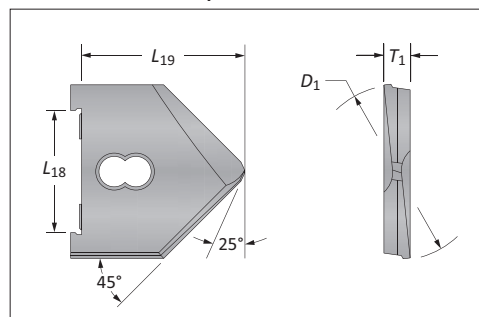

A40: 44 - 45

A40: 28 - 29

A40: 2

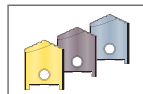
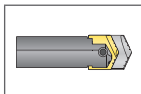
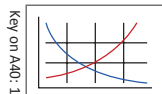

Sizes not shown are available upon request.
When ordering, please follow the example below:

Inch:	1-17/64", 130° CPM-M4 (B series) = use Part No. 10224-1.2656
Decimal:	1.5110", 130° Flat Bottom (C series) = use Part No. 10434-1.5110

High Performance / Universal Spade Drill Insert Holders

F Series

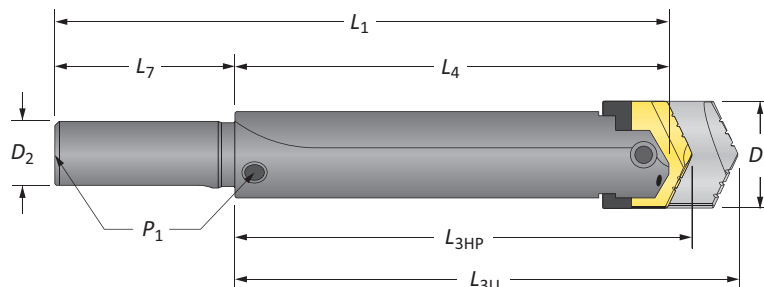

Straight Shank

Length	Holder					Shank				Style	Part No.
	D_1	L_{3HP}	L_{3U}	L_4	L_1	D_2	L_7	P_1			
Stub	3 - 3-7/8	3-13/32	4	2-3/4	6-3/4	2-1/2	4	-	#125	20261-2500	
Short	3 - 3-7/8	6-5/32	6-3/4	5-1/2	9-1/2	2	4	-	#150	20461-2000	
Short	3 - 3-7/8	6-5/32	6-3/4	5-1/2	9-1/2	2	4	1/2	#100	20661-2000	
Short	3 - 3-7/8	6-5/32	6-3/4	5-1/2	9-1/2	2-1/2	4	1/2	#100	20661-2500	
Standard	3 - 3-7/8	12-5/32	12-3/4	11-1/2	15-1/2	2	4	1/2	#200	20861-2000	
Long	3 - 3-7/8	20-21/32	21-1/4	20	24	2-1/2	4	1/2	#250	21061-2500	

NOTE: Adapter is required for D-H series High Performance spade drills. Adapters sold separately.

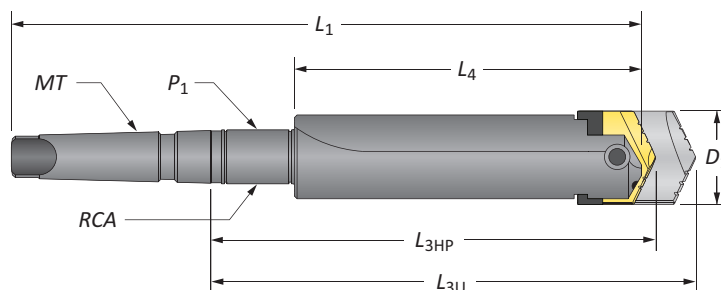

Taper Shank

Length	Holder					Shank			Style	Part No.
	D_1	L_{3HP}	L_{3U}	L_4	L_1	MT	P_1	RCA		
Short	3 - 3-7/8	6-13/32	7	5-1/2	11-5/8	#5	-	-	#300	21461-0005
Short	3 - 3-7/8	6-13/32	7	5-1/2	11-5/8	#5	-	-	#300 TSC	21561-0005*
Short	3 - 3-7/8	8-23/32	9-5/16	5-1/2	13-15/16	#5	1/2	2T-6SR	#400 SR	21661-0005
Standard	3 - 3-7/8	14-23/32	15-5/16	11-1/2	19-15/16	#5	1/2	2T-6SR	#500 SR	21861-0005
Long	3 - 3-7/8	23-7/32	23-13/16	20	28-7/16	#5	1/2	2T-6SR	#600 SR	22061-0005
XL	3 - 3-7/8	36-7/32	36-13/16	33	41-7/16	#5	1/2	2T-6SR	#700 SR	22261-0005

*Through shank coolant, coolant inlet diameter = 3/8"

NOTE: Adapter is required for D-H series High Performance spade drills. Adapters sold separately.

Connection Accessories

<p>Clamping Screw 1/2"-13 x 1-3/4"</p>	<p>Blade-Loc Screw 5/16"-18 x 1/2"</p>
---	---

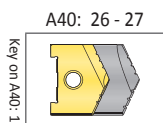

i = Imperial (in)
m = Metric (mm)

WARNING Refer to Speed and Feed charts for recommended adjustments to speeds and feeds. Refer to page A40: 48 for deep hole drilling guidelines in this section of the catalog. Visit www.alliedmachine.com/DeepHoleGuidelines for the most up-to-date information and procedures. Factory technical assistance is available for your specific applications through our Application Engineering Team.

High Performance / Universal Spade Drill Insert Holders

F Series

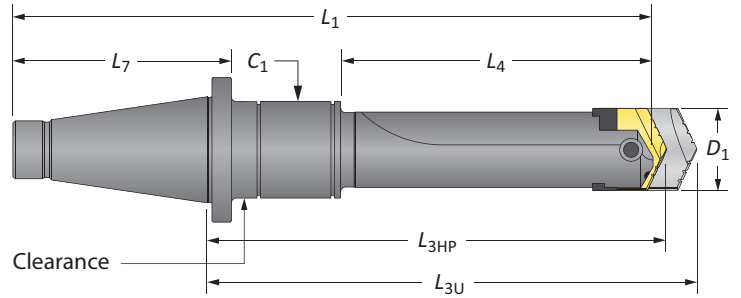

50 NMTB Shank*

Length	D ₁	Holder				Shank					Part No.
		L _{3HP}	L _{3U}	L ₄	L ₁	NMTB	L ₇	C ₁	RCA	Style	
Short	3 - 3-7/8	7-9/32	7-7/8	5-1/2	11-5/8	50	5-5/8	–	–	#300	22461-0050
Short	3 - 3-7/8	9-19/32	10-3/16	5-1/2	13-15/16	50	5-5/8	5/8	2T-60SR	#400	22661-0050
Short	3 - 3-7/8	15-19/32	16-3/16	11-1/2	19-15/16	50	5-5/8	5/8	2T-60SR	#500	22861-0050

*All NMTB shank holders are discontinued items. Items listed are available (subject to prior sale) at list prices until stock is depleted. Once stock is depleted, items are available as quoted specials only.

Rotary Coolant Adapter (RCA) and Accessories

ID	OD	L ₁	Driving Rod Thread	P ₁	Part No.*	RCA O-Rings	
						Kit Part No.**	Replacements
2-1/4	3-3/4	1-3/4	1/2 - NC	1/2	2T-6SR	2T1-6SR	2T1-6OR-10
3	4-1/2	1-3/4	1/2 - NC	1/2	2T-6OSR	2T1-6OSR	2T1-6OOR-10

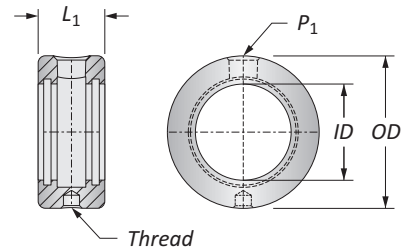



*RCA comes complete with (1) RCA, (2) O-rings, (2) snap rings, and (2) thrust washers

**RCA Repair Kit includes (2) O-rings, (2) snap rings, and (2) thrust washers

▲ Refer to page A40: 40 for proper RCA assembly and safety information

Connection Accessories

	
Clamping Screw	Blade-Loc Screw
1/2"-13 x 1-3/4"	5/16"-18 x 1/2"

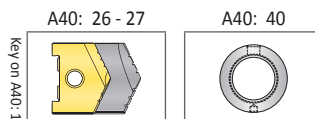

ⓘ = Imperial (in)
 ⓘ = Metric (mm)
 O-rings sold in packs of 10

WARNING RCA rotation during drilling can cause hose and/or hose fitting failure, machinery damage, and/or serious injury. To prevent, use RCA and positive stop studs when drilling. Factory technical assistance is also available for your specific applications.

High Performance Spade Drill Inserts

G Series | Diameter Range: 3.5000" - 4.5000"

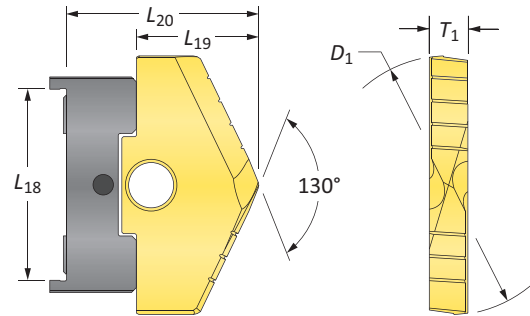
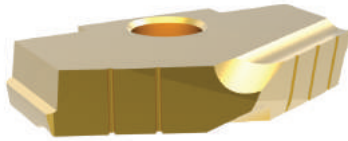

Series	D ₁ inch		Insert				TiN Part No.	TiAlN Part No.	TiCN Part No.	Adapter
	Fraction	Decimal	L ₁₈	L ₁₉	L ₂₀	T ₁				
G	3-1/2	3.5000	3-1/16	1-15/16	2-23/32	5/8	1027T-0316	1027A-0316	1027N-0316	1027U-Adapter
	3-17/32	3.5313	3-1/16	1-15/16	2-23/32	5/8	1027T-0317	1027A-0317	1027N-0317	1027U-Adapter
	3-9/16	3.5625	3-1/16	1-15/16	2-23/32	5/8	1027T-0318	1027A-0318	1027N-0318	1027U-Adapter
	3-19/32	3.5938	3-1/16	1-15/16	2-23/32	5/8	1027T-0319	1027A-0319	1027N-0319	1027U-Adapter
	3-5/8	3.6250	3-1/16	1-15/16	2-23/32	5/8	1027T-0320	1027A-0320	1027N-0320	1027U-Adapter
	3-21/32	3.6563	3-1/16	1-15/16	2-23/32	5/8	1027T-0321	1027A-0321	1027N-0321	1027U-Adapter
	3-11/16	3.6875	3-1/16	1-15/16	2-23/32	5/8	1027T-0322	1027A-0322	1027N-0322	1027U-Adapter
	3-23/32	3.7188	3-1/16	1-15/16	2-23/32	5/8	1027T-0323	1027A-0323	1027N-0323	1027U-Adapter
	3-3/4	3.7500	3-1/16	1-15/16	2-23/32	5/8	1027T-0324	1027A-0324	1027N-0324	1027U-Adapter
	3-25/32	3.7813	3-1/16	1-15/16	2-23/32	5/8	1027T-0325	1027A-0325	1027N-0325	1027U-Adapter
	3-13/16	3.8125	3-1/16	1-15/16	2-23/32	5/8	1027T-0326	1027A-0326	1027N-0326	1027U-Adapter
	3-27/32	3.8438	3-1/16	1-15/16	2-23/32	5/8	1027T-0327	1027A-0327	1027N-0327	1027U-Adapter
	3-7/8	3.8750	3-1/16	1-15/16	2-23/32	5/8	1027T-0328	1027A-0328	1027N-0328	1027U-Adapter
	3-29/32	3.9063	3-1/16	1-15/16	2-23/32	5/8	1027T-0329	1027A-0329	1027N-0329	1027U-Adapter
	3-15/16	3.9375	3-1/16	1-15/16	2-23/32	5/8	1027T-0330	1027A-0330	1027N-0330	1027U-Adapter
3-31/32	3.9688	3-1/16	1-15/16	2-23/32	5/8	1027T-0331	1027A-0331	1027N-0331	1027U-Adapter	
4	4.0000	3-1/16	1-15/16	2-23/32	5/8	1027T-0400	1027A-0400	1027N-0400	1027U-Adapter	
G Oversize	4-1/16	4.0625	3-1/16	1-15/16	2-23/32	5/8	1027T-0402	1027A-0402	1027N-0402	1027U-Adapter
	4-1/8	4.1250	3-1/16	1-15/16	2-23/32	5/8	1027T-0404	1027A-0404	1027N-0404	1027U-Adapter
	4-3/16	4.1875	3-1/16	1-15/16	2-23/32	5/8	1027T-0406	1027A-0406	1027N-0406	1027U-Adapter
	4-1/4	4.2500	3-1/16	1-15/16	2-23/32	5/8	1027T-0408	1027A-0408	1027N-0408	1027U-Adapter
	4-5/16	4.3125	3-1/16	1-15/16	2-23/32	5/8	1027T-0410	1027A-0410	1027N-0410	1027U-Adapter
	4-3/8	4.3750	3-1/16	1-15/16	2-23/32	5/8	1027T-0412	1027A-0412	1027N-0412	1027U-Adapter
	4-7/16	4.4375	3-1/16	1-15/16	2-23/32	5/8	1027T-0414	1027A-0414	1027N-0414	1027U-Adapter
4-1/2	4.5000	3-1/16	1-15/16	2-23/32	5/8	1027T-0416	1027A-0416	1027N-0416	1027U-Adapter	

NOTE: Adapter is required for D-H series High Performance spade drills. Adapters sold separately.

Inserts sold in multiples of 1

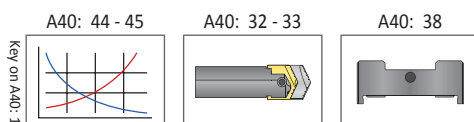

Sizes not shown are available upon request.

When ordering, please follow the example below:

Inch:	7-63/64", 130° CPM-M4 (H8 series) = use Part No. 10294-7.9843
Decimal:	6.391", 130° CPM-M4 (H5 series) = use Part No. 10294-6.3910



Universal Spade Drill Inserts

G Series | Diameter Range: 3.5000" - 4.5000"

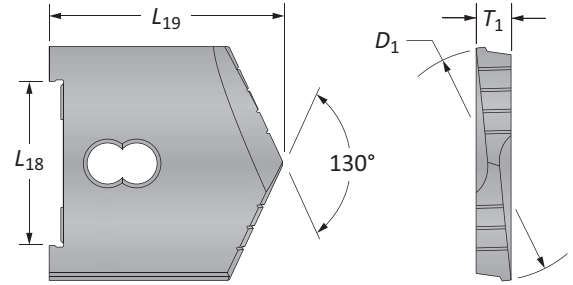

Series	D ₁ inch		Insert					
	Fraction	Decimal	L ₁₈	L ₁₉	T ₁	130° CPM-M4	130° CPM-T15*	Flat Bottom
G	3-1/2	3.5000	3-1/16	3-3/8	5/8	10274-0316	10275-0316	10474-0316
	3-17/32	3.5313	3-1/16	3-3/8	5/8	10274-0317	-	-
	3-9/16	3.5625	3-1/16	3-3/8	5/8	10274-0318	10275-0318	10474-0318
	3-19/32	3.5938	3-1/16	3-3/8	5/8	10274-0319	-	-
	3-5/8	3.6250	3-1/16	3-3/8	5/8	10274-0320	10275-0320	10474-0320
	3-21/32	3.6563	3-1/16	3-3/8	5/8	10274-0321	-	-
	3-11/16	3.6875	3-1/16	3-3/8	5/8	10274-0322	10275-0322	10474-0322
	3-23/32	3.7188	3-1/16	3-3/8	5/8	10274-0323	-	-
	3-3/4	3.7500	3-1/16	3-3/8	5/8	10274-0324	10275-0324	10474-0324
	3-25/32	3.7813	3-1/16	3-3/8	5/8	10274-0325	-	-
	3-13/16	3.8125	3-1/16	3-3/8	5/8	10274-0326	10275-0326	10474-0326
	3-27/32	3.8438	3-1/16	3-3/8	5/8	10274-0327	-	-
	3-7/8	3.8750	3-1/16	3-3/8	5/8	10274-0328	10275-0328	10474-0328
	3-29/32	3.9063	3-1/16	3-3/8	5/8	10274-0329	-	-
	3-15/16	3.9375	3-1/16	3-3/8	5/8	10274-0330	10275-0330	10474-0330
3-31/32	3.9688	3-1/16	3-3/8	5/8	10274-0331	-	-	
4	4.0000	3-1/16	3-3/8	5/8	10274-0400	10275-0400	10474-0400	
G Oversize	4-1/16	4.0625	3-1/16	3-3/8	5/8	10274-0402	-	-
	4-1/8	4.1250	3-1/16	3-3/8	5/8	10274-0404	-	-
	4-3/16	4.1875	3-1/16	3-3/8	5/8	10274-0406	-	-
	4-1/4	4.2500	3-1/16	3-3/8	5/8	10274-0408	-	-
	4-5/16	4.3125	3-1/16	3-3/8	5/8	10274-0410	-	-
	4-3/8	4.3750	3-1/16	3-3/8	5/8	10274-0412	-	-
	4-7/16	4.4375	3-1/16	3-3/8	5/8	10274-0414	-	-
4-1/2	4.5000	3-1/16	3-3/8	5/8	10274-0416	-	-	

*Discontinued

Inserts sold in multiples of 1

NOTE: POR = Priced on request

Flat Bottom

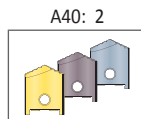
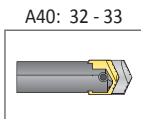
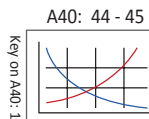
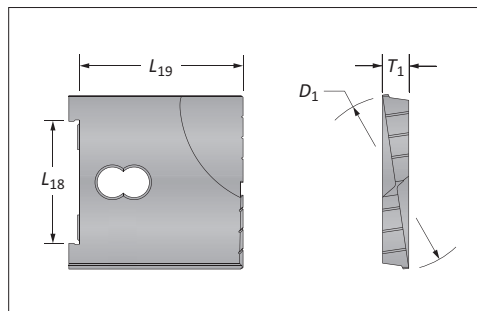

Sizes not shown are available upon request.
When ordering, please follow the example below:

Inch:	1-17/64", 130° CPM-M4 (B series) = use Part No. 10224-1.2656
Decimal:	1.5110", 130° Flat Bottom (C series) = use Part No. 10434-1.5110

High Performance / Universal Spade Drill Insert Holders

G Series

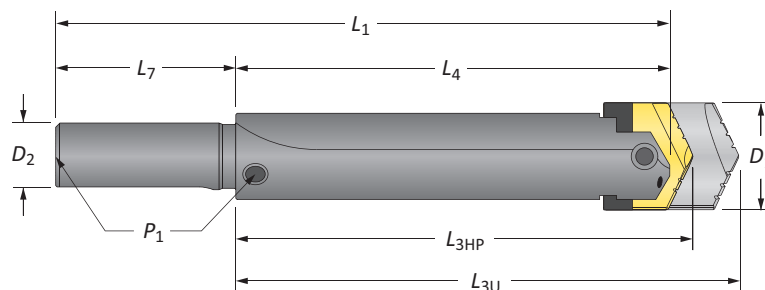

Straight Shank

	Length	Holder				Shank				Style	Part No.
		D_1	L_{3HP}	L_{3U}	L_4	L_1	D_2	L_7	P_1		
i	Short	3-1/2 - 4-1/2	6-25/32	7-7/16	6	11	2-1/2	5	1/2	#100	20671-2500
	Standard	3-1/2 - 4-1/2	13-25/32	14-7/16	13	18	2-1/2	5	1/2	#200	20871-2500

NOTE: Adapter is required for D-H series High Performance spade drills. Adapters sold separately.

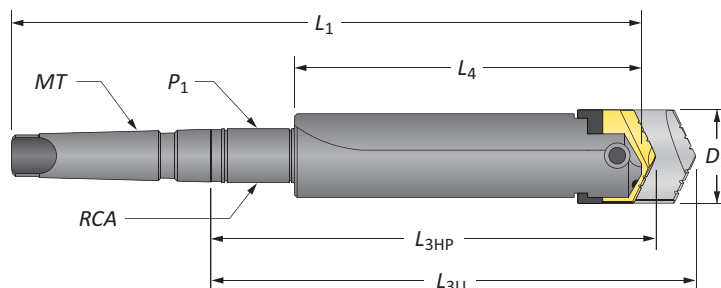

Taper Shank

	Length	Holder				Shank				Style	Part No.
		D_1	L_{3HP}	L_{3U}	L_4	L_1	MT	P_1	RCA		
i	Short	3-1/2 - 4-1/2	7-1/32	7-11/16	6	12-1/8	#5	-	-	#300	21471-0005
	Short	3-1/2 - 4-1/2	7-1/32	7-11/16	6	12-1/8	#5	-	-	#300 TSC	21571-0005*
	Short	3-1/2 - 4-1/2	9-11/32	10	6	14-7/16	#5	1/2	2T-6SR	#400 SR	21671-0005
	Standard	3-1/2 - 4-1/2	16-11/32	17	13	21-7/16	#5	1/2	2T-6SR	#500 SR	21871-0005
	Long	3-1/2 - 4-1/2	27-11/32	28	24	32-7/16	#5	1/2	2T-6SR	#600 SR	22071-0005
	XL	3-1/2 - 4-1/2	40-11/32	41	37	45-7/16	#5	1/2	2T-6SR	#700 SR	22271-0005

*Through shank coolant, coolant inlet diameter = 3/8"

NOTE: Adapter is required for D-H series High Performance spade drills. Adapters sold separately.

Connection Accessories

<p>Clamping Screw 3/4"-10 x 2-1/2"</p>	<p>Blade-Loc Screw 5/16"-18 x 1/2"</p>
---	---

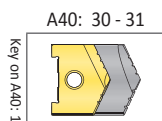

i = Imperial (in)
m = Metric (mm)

WARNING Refer to Speed and Feed charts for recommended adjustments to speeds and feeds. Refer to page A40: 48 for deep hole drilling guidelines in this section of the catalog. Visit www.alliedmachine.com/DeepHoleGuidelines for the most up-to-date information and procedures. Factory technical assistance is available for your specific applications through our Application Engineering Team.

High Performance / Universal Spade Drill Insert Holders

G Series

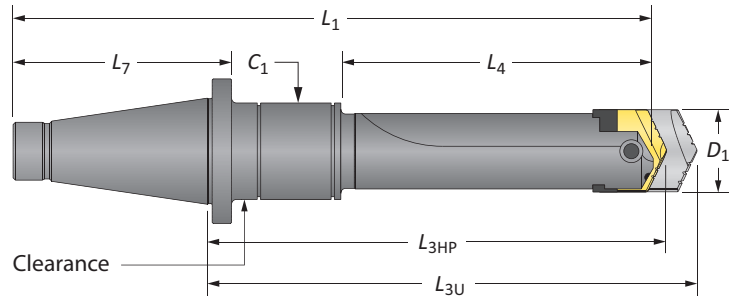

50 NMTB Shank*

Length	D ₁	Holder				Shank					Part No.
		L _{3HP}	L _{3U}	L ₄	L ₁	NMTB	L ₇	C ₁	RCA	Style	
Short	3-1/2 - 4-1/2	8-29/32	9-9/16	7	13-1/8	50	5-5/8	–	–	#300	22471-0050
Short	3-1/2 - 4-1/2	11-7/32	11-7/8	7	15-7/16	50	5-5/8	5/8	2T-65SR	#400	22671-0050
Short	3-1/2 - 4-1/2	19-13/32	20	15	23-7/16	50	5-5/8	5/8	2T-65SR	#500	22881-0050

*All NMTB shank holders are discontinued items. Items listed are available (subject to prior sale) at list prices until stock is depleted. Once stock is depleted, items are available as quoted specials only.

Rotary Coolant Adapter (RCA) and Accessories

ID	OD	L ₁	Driving Rod Thread	P ₁	Part No.*	RCA O-Rings	
						Kit Part No.**	Replacements
2-1/4	3-3/4	1-3/4	1/2 - NC	1/2	2T-6SR	2T1-6SR	2T1-6OR-10
3-3/4	5-1/2	1-3/4	1/2 - NC	1/2	2T-65SR	2T1-65SR	2T1-65OR-10



*RCA comes complete with (1) RCA, (2) O-rings, (2) snap rings, and (2) thrust washers

**RCA Repair Kit includes (2) O-rings, (2) snap rings, and (2) thrust washers

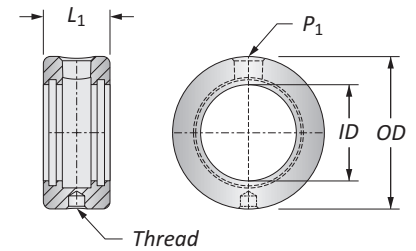
▲ Refer to page A40: 40 for proper RCA assembly and safety information



Connection Accessories

	
Clamping Screw	Blade-Loc Screw
3/4"-10 x 2-1/2"	5/16"-18 x 1/2"

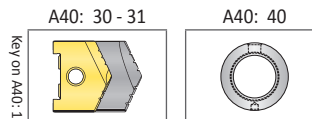

ⓘ = Imperial (in)
 ⓘ = Metric (mm)
 O-rings sold in packs of 10

⚠ WARNING RCA rotation during drilling can cause hose and/or hose fitting failure, machinery damage, and/or serious injury. To prevent, use RCA and positive stop studs when drilling. Factory technical assistance is also available for your specific applications.

High Performance Spade Drill Inserts

H Series | Diameter Range: 4.0000" - 5.0000"

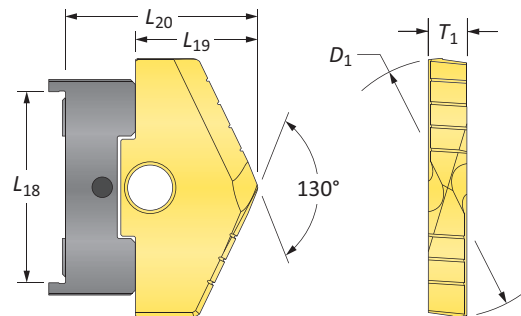
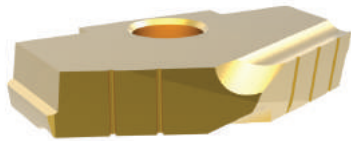

Series	D ₁ inch		Insert							
	Fraction	Decimal	L ₁₈	L ₁₉	L ₂₀	T ₁	TiN Part No.	TiAlN Part No.	TiCN Part No.	Adapter
H ¹	4	4.0000	3-1/2	2-3/16	3-3/32	11/16	1028T-0400	1028A-0400	1028N-0400	1028U-Adapter
	4-1/16	4.0625	3-1/2	2-3/16	3-3/32	11/16	1028T-0402	1028A-0402	1028N-0402	1028U-Adapter
	4-1/8	4.1250	3-1/2	2-3/16	3-3/32	11/16	1028T-0404	1028A-0404	1028N-0404	1028U-Adapter
	4-3/16	4.1875	3-1/2	2-3/16	3-3/32	11/16	1028T-0406	1028A-0406	1028N-0406	1028U-Adapter
	4-1/4	4.2500	3-1/2	2-3/16	3-3/32	11/16	1028T-0408	1028A-0408	1028N-0408	1028U-Adapter
	4-5/16	4.3125	3-1/2	2-3/16	3-3/32	11/16	1028T-0410	1028A-0410	1028N-0410	1028U-Adapter
	4-3/8	4.3750	3-1/2	2-3/16	3-3/32	11/16	1028T-0412	1028A-0412	1028N-0412	1028U-Adapter
	4-7/16	4.4375	3-1/2	2-3/16	3-3/32	11/16	1028T-0414	1028A-0414	1028N-0414	1028U-Adapter
H ²	4-1/2	4.5000	3-1/2	2-3/16	3-3/32	11/16	1028T-0416	1028A-0416	1028N-0416	1028U-Adapter
	4-9/16	4.5625	3-1/2	2-3/16	3-3/32	11/16	1028T-0418	1028A-0418	1028N-0418	1028U-Adapter
	4-5/8	4.6250	3-1/2	2-3/16	3-3/32	11/16	1028T-0420	1028A-0420	1028N-0420	1028U-Adapter
	4-11/16	4.6875	3-1/2	2-3/16	3-3/32	11/16	1028T-0422	1028A-0422	1028N-0422	1028U-Adapter
	4-3/4	4.7500	3-1/2	2-3/16	3-3/32	11/16	1028T-0424	1028A-0424	1028N-0424	1028U-Adapter
	4-13/16	4.8125	3-1/2	2-3/16	3-3/32	11/16	1028T-0426	1028A-0426	1028N-0426	1028U-Adapter
	4-7/8	4.8750	3-1/2	2-3/16	3-3/32	11/16	1028T-0428	1028A-0428	1028N-0428	1028U-Adapter
	4-15/16	4.9375	3-1/2	2-3/16	3-3/32	11/16	1028T-0430	1028A-0430	1028N-0430	1028U-Adapter
5	5.0000	3-1/2	2-3/16	3-3/32	11/16	1028T-0500	1028A-0500	1028N-0500	1028U-Adapter	

NOTE: Adapter is required for D-H series High Performance spade drills. Adapters sold separately.

Inserts sold in multiples of 1

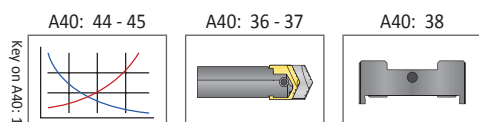

Sizes not shown are available upon request.

When ordering, please follow the example below:

Inch:	7-63/64", 130° CPM-M4 (H8 series) = use Part No. 10294-7.9843
Decimal:	6.391", 130° CPM-M4 (H5 series) = use Part No. 10294-6.3910



Universal Spade Drill Inserts

H¹ - H² Series | Diameter Range: 4.0000" - 8.5000"

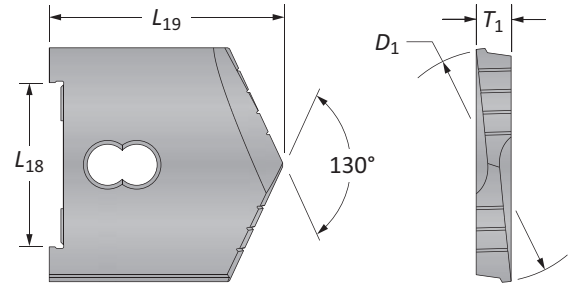

Series	D ₁ inch		Insert					
	Fraction	Decimal	L ₁₈	L ₁₉	T ₁	130° CPM-M4	130° CPM-T15*	Flat Bottom
H ¹	4	4.0000	3-1/2	3-11/16	11/16	10284-0400	10285-0400	10484-0400
	4-1/16	4.0625	3-1/2	3-11/16	11/16	10284-0402	-	-
	4-1/8	4.1250	3-1/2	3-11/16	11/16	10284-0404	10285-0404	10484-0404
	4-3/16	4.1875	3-1/2	3-11/16	11/16	10284-0406	-	-
	4-1/4	4.2500	3-1/2	3-11/16	11/16	10284-0408	-	10484-0408
	4-5/16	4.3125	3-1/2	3-11/16	11/16	10284-0410	-	-
	4-3/8	4.3750	3-1/2	3-11/16	11/16	10284-0412	-	10484-0412
	4-7/16	4.4375	3-1/2	3-11/16	11/16	10284-0414	-	-
H ²	4-1/2	4.5000	3-1/2	3-11/16	11/16	10284-0416	10285-0416	10484-0416
	4-9/16	4.5625	3-1/2	3-11/16	11/16	10284-0418	-	-
	4-5/8	4.6250	3-1/2	3-11/16	11/16	10284-0420	-	10484-0420
	4-11/16	4.6875	3-1/2	3-11/16	11/16	10284-0422	-	-
	4-3/4	4.7500	3-1/2	3-11/16	11/16	10284-0424	-	10484-0424
	4-13/16	4.8125	3-1/2	3-11/16	11/16	10284-0426	-	-
	4-7/8	4.8750	3-1/2	3-11/16	11/16	10284-0428	-	10484-0428
	4-15/16	4.9375	3-1/2	3-11/16	11/16	10284-0430	-	-
	5	5.0000	3-1/2	3-11/16	11/16	10284-0500	10285-0500	10484-0500

*Discontinued

Inserts sold in multiples of 1

NOTE: POR = Priced on request

Flat Bottom

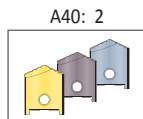
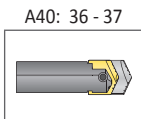
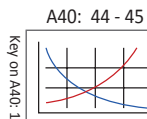
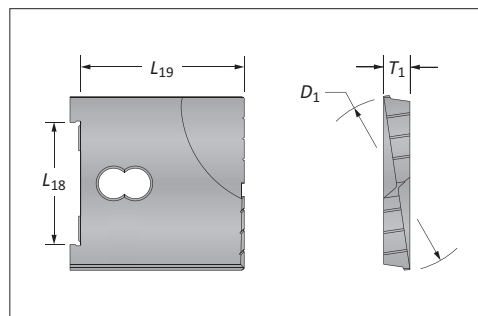

Sizes not shown are available upon request.
When ordering, please follow the example below:

Inch:	1-17/64", 130° CPM-M4 (B series) = use Part No. 10224-1.2656
Decimal:	1.5110", 130° Flat Bottom (C series) = use Part No. 10434-1.5110

Universal Spade Drill Inserts

H³ - H⁹ Series | Diameter Range: 5.1250" - 8.5000"

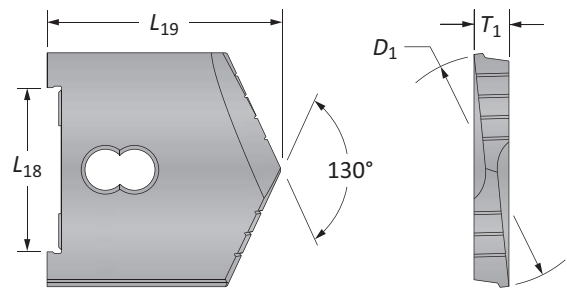

Series	D ₁ inch		Insert			 130° CPM-M4
	Fraction	Decimal	L ₁₈	L ₁₉	T ₁	
H ³	5-1/8	5.1250	3-1/2	3-11/16	11/16	10294-0504
	5-1/4	5.2500	3-1/2	3-11/16	11/16	10294-0508
	5-3/8	5.3750	3-1/2	3-11/16	11/16	10294-0512
	5-1/2	5.5000	3-1/2	3-11/16	11/16	10294-0516
H ⁴	5-5/8	5.6250	3-1/2	3-11/16	11/16	10294-0520
	5-3/4	5.7500	3-1/2	3-11/16	11/16	10294-0524
	5-7/8	5.8750	3-1/2	3-11/16	11/16	10294-0528
	6	6.0000	3-1/2	3-11/16	11/16	10294-0600
H ⁵	6-1/8	6.1250	3-1/2	3-11/16	11/16	10294-0604
	6-1/4	6.2500	3-1/2	3-11/16	11/16	10294-0608
	6-3/8	6.3750	3-1/2	3-11/16	11/16	10294-0612
	6-1/2	6.5000	3-1/2	3-11/16	11/16	10294-0616
H ⁶	6-5/8	6.6250	3-1/2	3-11/16	11/16	10294-0620
	6-3/4	6.7500	3-1/2	3-11/16	11/16	10294-0624
	6-7/8	6.8750	3-1/2	3-11/16	11/16	10294-0628
	7	7.0000	3-1/2	3-11/16	11/16	10294-0700
H ⁷	7-1/8	7.1250	3-1/2	3-11/16	11/16	10294-0704
	7-1/4	7.2500	3-1/2	3-11/16	11/16	10294-0708
	7-3/8	7.3750	3-1/2	3-11/16	11/16	10294-0712
	7-1/2	7.5000	3-1/2	3-11/16	11/16	10294-0716
H ⁸	7-5/8	7.6250	3-1/2	3-11/16	11/16	10294-0720
	7-3/4	7.7500	3-1/2	3-11/16	11/16	10294-0724
	7-7/8	7.8750	3-1/2	3-11/16	11/16	10294-0728
	8	8.0000	3-1/2	3-11/16	11/16	10294-0800
H ⁹	8-1/8	8.1250	3-1/2	3-11/16	11/16	10294-0804
	8-1/4	8.2500	3-1/2	3-11/16	11/16	10294-0808
	8-3/8	8.3750	3-1/2	3-11/16	11/16	10294-0812
	8-1/2	8.5000	3-1/2	3-11/16	11/16	10294-0816

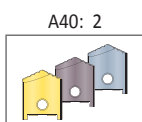
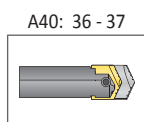
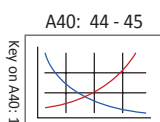

Sizes not shown are available upon request.
When ordering, please follow the example below:

Inch:	1-17/64", 130° CPM-M4 (B series) = use Part No. 10224-1.2656
Decimal:	1.5110", 130° Flat Bottom (C series) = use Part No. 10434-1.5110

High Performance / Universal Spade Drill Insert Holders

H Series

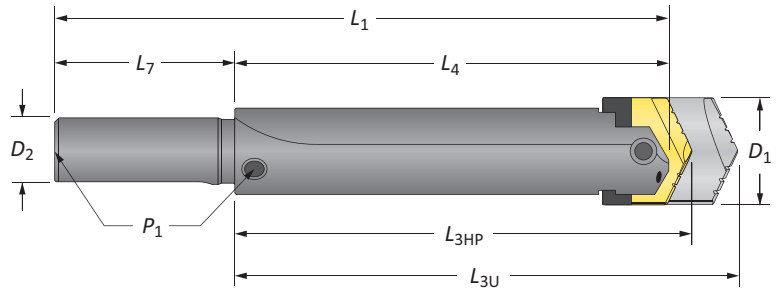

Straight Shank

Length	D ₁	Holder				Shank				Style	Part No.
		L _{3HP}	L _{3U}	L ₄	L ₁	D ₂	L ₇	P ₁			
Short	4 - 8-1/2	7-31/32	8-9/16	7	13	2-1/2	6	1/2	#100	20681-2500	
Standard	4 - 8-1/2	15-31/32	16-9/16	15	21	2-1/2	6	1/2	#200	20881-2500	

NOTE: Adapter is required for D-H series High Performance spade drills. Adapters sold separately.

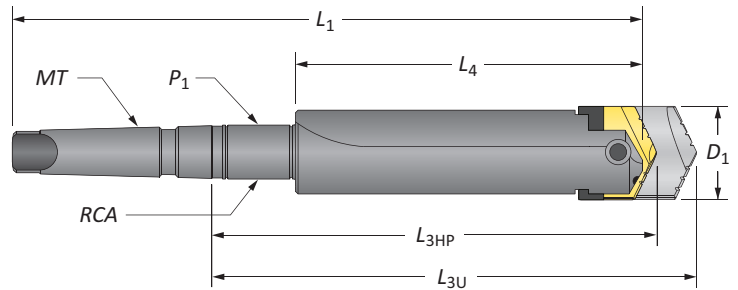

Taper Shank

Length	D ₁	Holder				MT	P ₁	RCA	Style	Part No.
		L _{3HP}	L _{3U}	L ₄	L ₁					
Short	4 - 8-1/2	8-7/32	8-13/16	7	13-1/8	#5	-	-	#300	21481-0005
Short	4 - 8-1/2	10-17/32	11-1/8	7	15-7/16	#5	1/2	2T-6SR	#400 SR	21681-0005
Standard	4 - 8-1/2	18-17/32	19-1/8	15	23-7/16	#5	1/2	2T-6SR	#500 SR	21881-0005
Standard	4 - 8-1/2	18-17/32	19-1/8	15	25-7/8	#6	1/2	2T-55SR	#500 SR	21881-0006
Long	4 - 8-1/2	27-19/32	28-3/16	24	34-7/8	#6	1/2	2T-55SR	#600 SR	22081-0006
XL	4 - 8-1/2	43-19/32	44-3/16	40	50-7/8	#6	1/2	2T-55SR	#700 SR	22281-0006

NOTE: Adapter is required for D-H series High Performance spade drills. Adapters sold separately.

Rotary Coolant Adapter (RCA) and Accessories

ID	OD	L ₁	Driving Rod Thread	P ₁	Part No.*	RCA O-Rings	
						Kit Part No.**	Replacements
2-1/4	3-3/4	1-3/4	1/2 - NC	1/2	2T-6SR	2T1-6SR	2T1-6OR-10
2-1/2	4	1-3/4	1/2 - NC	1/2	2T-55SR	2T1-55SR	2T1-55OR-10



*RCA comes complete with (1) RCA, (2) O-rings, (2) snap rings, and (2) thrust washers

**RCA Repair Kit includes (2) O-rings, (2) snap rings, and (2) thrust washers

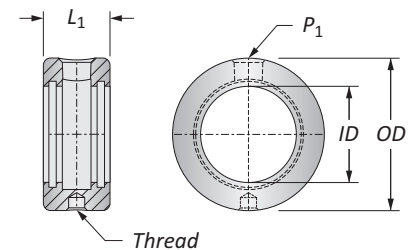
▲ Refer to page A40: 40 for proper RCA assembly and safety information



Connection Accessories

	
Clamping Screw	Blade-Loc Screw
3/4"-10 x 2-1/2"	3/8"-16 x 3/4"

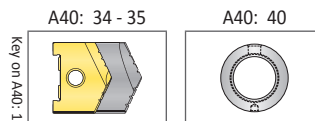

ⓘ = Imperial (in)
Ⓜ = Metric (mm)
O-rings sold in packs of 10

WARNING Refer to Speed and Feed charts for recommended adjustments to speeds and feeds. Refer to page A40: 48 for deep hole drilling guidelines in this section of the catalog. Visit www.alliedmachine.com/DeepHoleGuidelines for the most up-to-date information and procedures. Factory technical assistance is available for your specific applications through our Application Engineering Team.



High Performance Spade Drill Insert Adapters

D - H Series

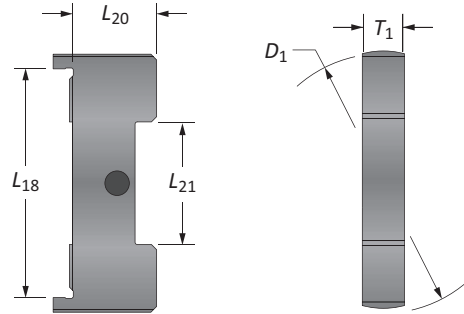

Series	D ₁	Adapter				Part No.
		L ₁₈	L ₂₀	L ₂₁	T ₁	
D	1.995	1-3/4	43/64	15/16	3/8	1024U-Adapter
E	2.495	2-1/16	21/32	1-3/16	7/16	1025U-Adapter
F	2.995	2-5/8	23/32	1-1/4	1/2	1026U-Adapter
G	3.495	3-1/16	25/32	1-13/16	5/8	1027U-Adapter
H	3.995	3-1/2	29/32	2-1/4	11/16	1028U-Adapter

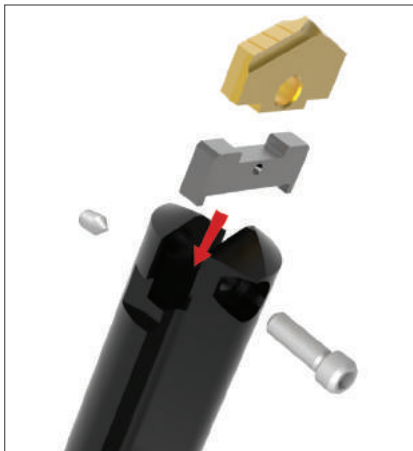

Step 1:
Position the adapter into the holder.

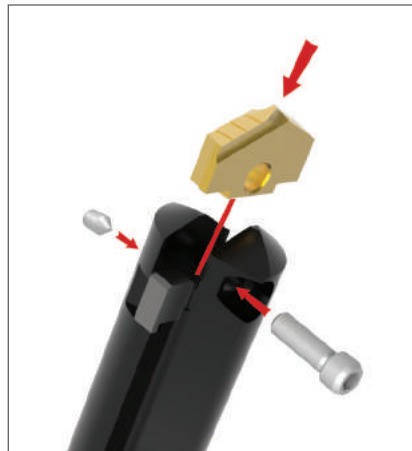

Step 2:
Slide the insert into the adapter inside the holder.



Step 3:
Insert and tighten both the clamping screw and Blade-Loc screw to secure the insert and adapter into position.

Adapter Interchangeability

- Adapters allow the use of complete spade drill insert range
- Needed for D - H series (not required for A - C series)
- Adapter + High Performance insert combination can be interchanged with Universal insert and/or other holders
- Manufactured to ANSI B94.49-1975 TYPE I specifications

Blade-Loc Drill Insert Holders

D - H Series

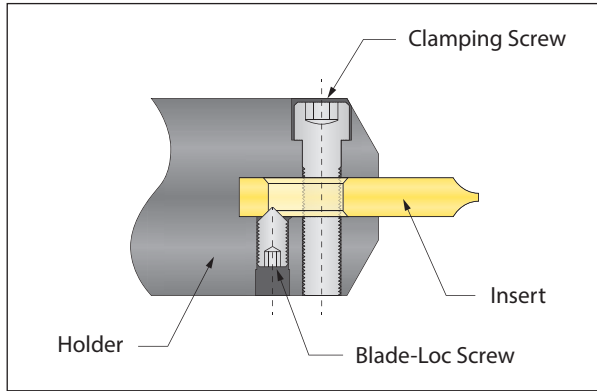

Universal Spade Drill Insert

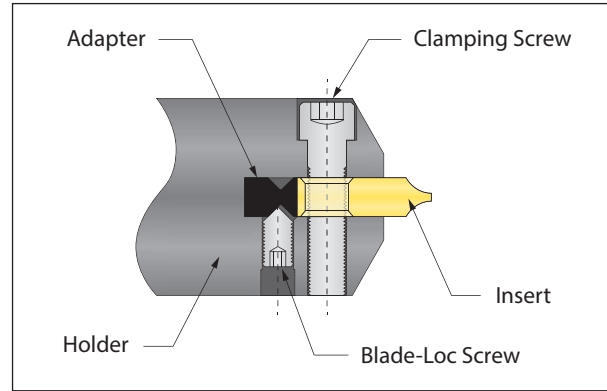



High Performance Spade Drill Insert

Blade-Loc Drill Holders - Universal

- Helps align the spade drill while locking it in place
- Protects against tool movement during the drilling cycle and when the tool is being retracted from the hole
- Standard feature in D - H series holders

Blade-Loc Drill Holders - High Performance

- Secures the adapter to the holder
- Allows inserts to be exchanged without any need to remove, clean, and re-insert the adapter

Series	 Clamping Screw	 Blade-Loc Screw
A	#10-24 x 5/8	-
B	1/4"-20 x 7/8	-
C	1/4"-20 x 1	-
D	3/8"-16 x 1-1/4"	5/16"-18 x 1/2"
E	1/2"-13 x 1-3/4"	5/16"-18 x 1/2"
F	5/8"-10 x 2	5/16"-18 x 1/2"
G	3/4"-10 x 2-1/2	5/16"-18 x 1/2"
H	3/4"-10 x 2-1/2	3/8"-16 x 3/4"

Rotary Coolant Adapters (RCA)

Morse Taper Shanks

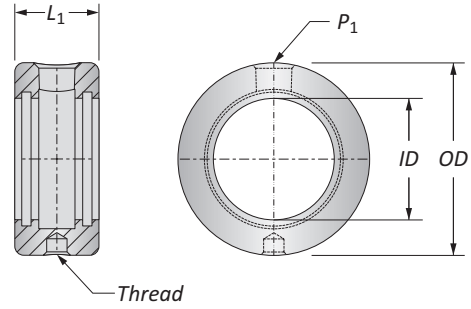

Holder Series	ID	OD	L ₁	Driving Rod Thread	P ₁	Part No.*	Max Recommended RPM	RCA O-Rings	
								Kit Part No.**	Replacements
A, B, C, D	1-1/4	2-1/2	1-3/8	3/8 - NC	1/4	⚠ 2T-4SR	2000	2T1-4SR	2T1-4OR-10
B, C, D	1-3/4	3	1-3/8	3/8 - NC	1/4	⚠ 2T-5SR	1500	2T1-5SR	2T1-5OR-10
E, F, G, H	2-1/4	3-3/4	1-3/4	1/2 - NC	1/2	⚠ 2T-6SR	1100	2T1-6SR	2T1-6OR-10
D, E, H	2-1/2	4	1-3/4	1/2 - NC	1/2	⚠ 2T-55SR	1100	2T1-55SR	2T1-55OR-10
F	3	4-1/2	1-3/4	1/2 - NC	1/2	⚠ 2T-60SR	900	2T1-60SR	2T1-60OR-10
G	3-3/4	5-1/2	1-3/4	1/2 - NC	1/2	⚠ 2T-65SR	700	2T1-65SR	2T1-65OR-10

*RCA comes complete with (1) RCA, (2) O-rings, (2) snap rings, and (2) thrust washers

**RCA Repair Kit includes (2) O-rings, (2) snap rings, and (2) thrust washers

NOTE: Max recommended pressure is 600 PSI (42 bar)

NOTE: Recommendations above are based on water and oil based coolants

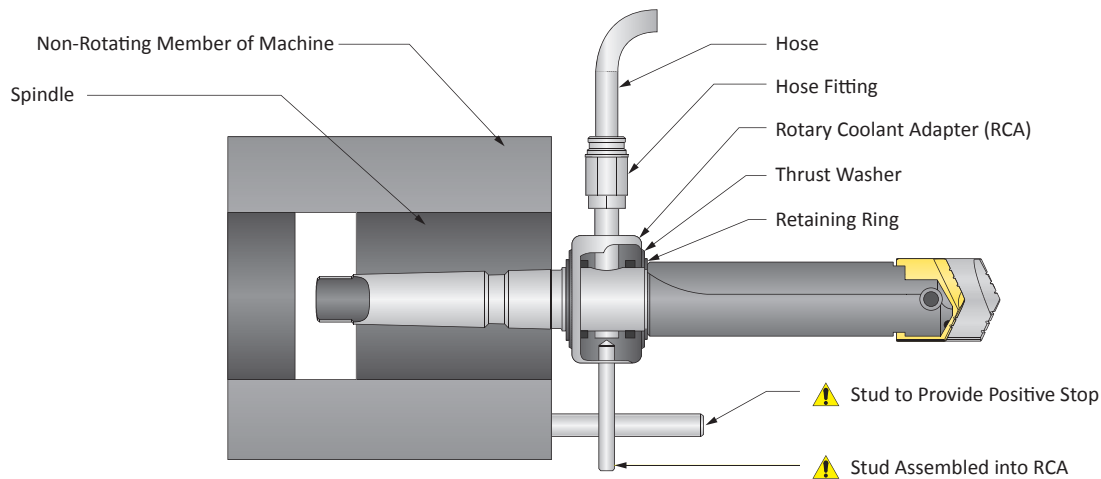

ⓘ = Imperial (in)

Ⓜ = Metric (mm)

O-rings sold in packs of 10

⚠ WARNING RCA rotation during drilling can cause hose and/or hose fitting failure, machinery damage, and/or serious injury. To prevent, use RCA and positive stop studs when drilling. Factory technical assistance is also available for your specific applications.

Accessories



Top Mounting Plate

Part No.	Description
25000-2505	Top mounting plate only. It is available for those who already have a Universal grinding fixture or may wish to adapt it to some other device. The plate comes complete with all the hardware required to locate and clamp any series Universal style spade drill to the plate.

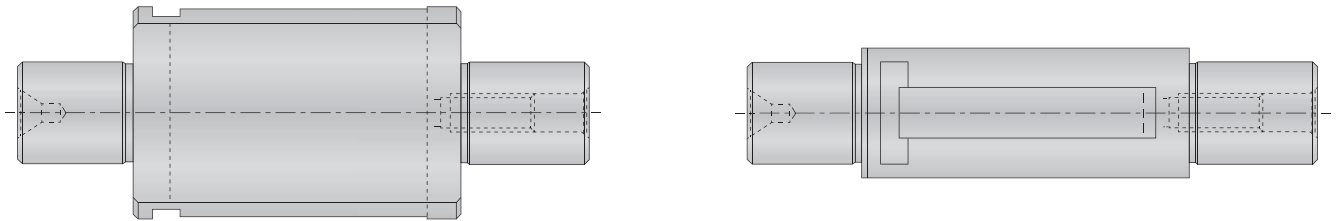

Cylindrical Grinding Fixture

Series	Diameter Range	Part No.
A	15/16 - 1-3/8	24410-2560
B	1-1/4 - 1-3/4	24420-2565
C	1-1/2 - 2-3/8	24430-2570
D	2 - 2-7/8	24440-2575
E	2-1/2 - 3-3/8	24450-2580
F	3 - 3-7/8	24460-2585
G	3-1/2 - 4-1/2	24470-2590
H*	4 - 8-1/2	24480-2595

Items included with the Cylindrical Grinding Fixture: (1) set screw, (1) slip pin

*Applies to drills with a reference length of 3-11/16". Cylindrical Grinding Fixtures for drills with a 4-11/16" reference length will be quoted upon request

Regrind Charts

Universal Inserts

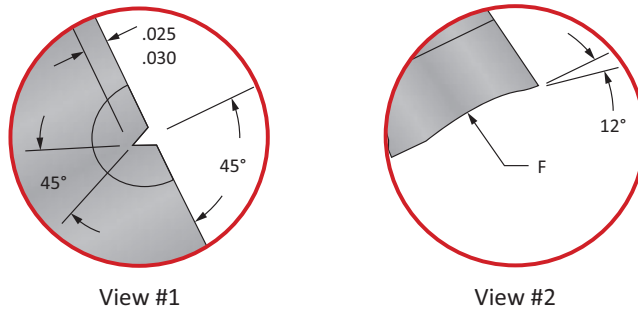
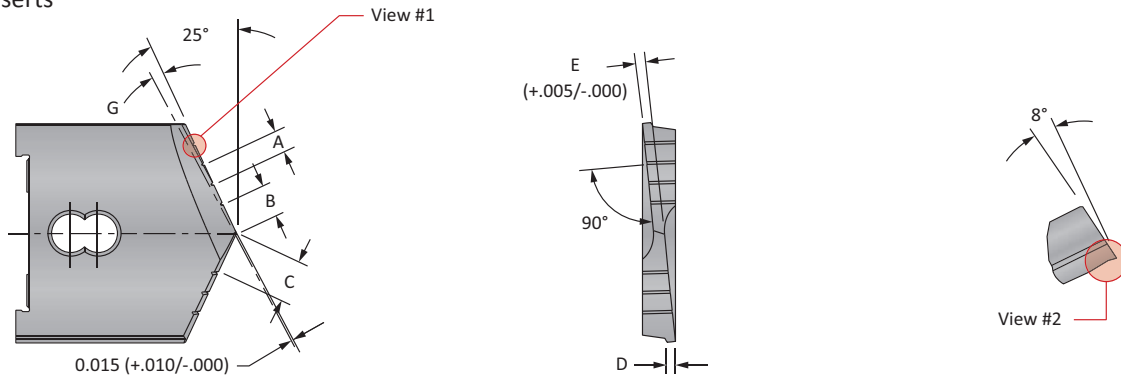

Universal (130°) Spade Drill Inserts

Series	Insert Thickness	Size Range	A	B	C	D	E	F	G
AA	1/4	1 - 1-3/8	0.125	0.156	0.218	0.065	0.070	1/4	3°
A	3/16	31/32 - 1-3/8	0.125	0.156	0.218	0.065	0.065	1/4	3°
B	9/32	1-1/4 - 1-3/4	0.150	0.250	0.325	0.070	0.090	5/16	3°
C	5/16	1-1/2 - 2-3/8	0.200	0.250	0.350	0.080	0.100	5/16	3°
D	3/8	2 - 2-7/8	0.250	0.375	0.500	0.100	0.120	3/8	3°
E	7/16	2-1/2 - 3-3/8	0.300	0.437	0.587	0.100	0.140	3/8	3°
F	1/2	3 - 3-7/8	0.350	0.437	0.612	0.125	0.170	3/8	3°
G	5/8	3-1/2 - 4-1/2	0.350	0.500	0.675	0.140	0.200	3/8	3°
H ¹ - H ²	11/16	4 - 5	0.400	0.500	0.700	0.165	0.225	1/2	3°
H ³	11/16	5-1/8 - 5-1/2	0.500	0.500	0.750	0.185	0.250	1/2	3°
H ⁴ - H ⁹	11/16	5-5/8 - 8-1/2	0.500	0.500	0.750	0.185	0.250	1/2	2°

NOTE: Maintain cutting edges of the tool within 0.001" T.I.R.

High Performance Regrinds: High Performance inserts should be reground and coated by Allied Machine before returning them to production. The real economy of High Performance spade inserts is their improved production rates (100% and 500%) and increased tool life (3 to 20 times). Factory regrounding and coating provides like-new tool performance. Our factory service reduces your total cost-per-hole.

Regrind Charts

Universal Inserts

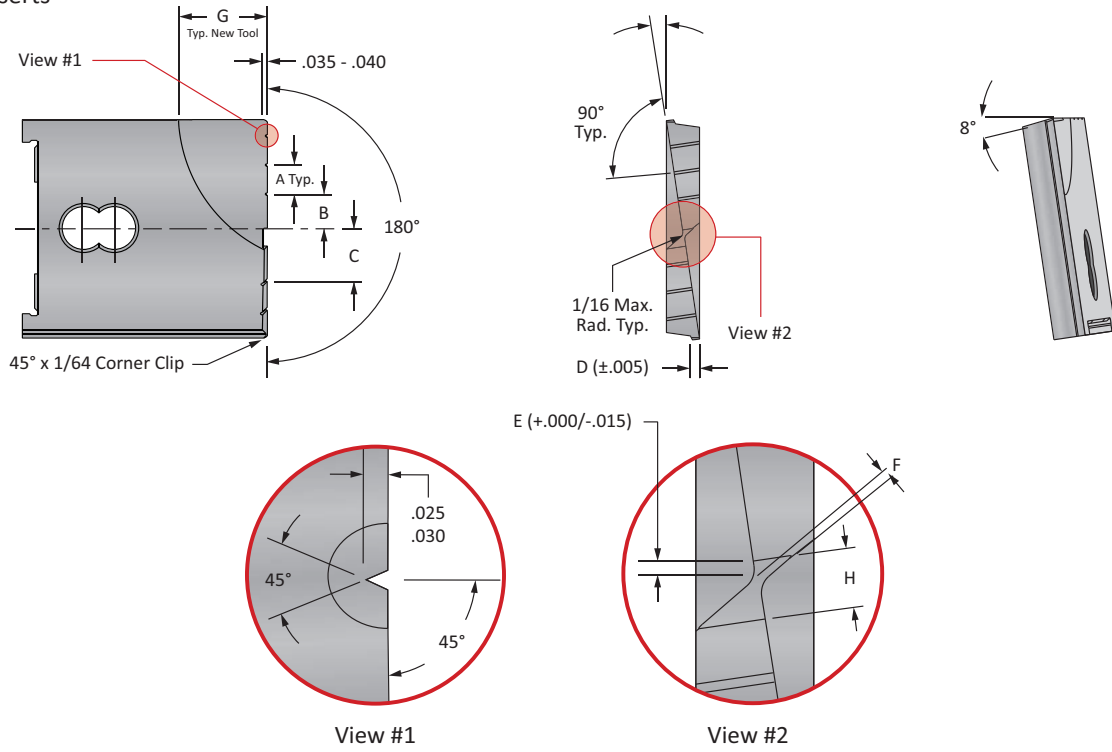

Flat Bottom Spade Drill Inserts



Series	Insert Thickness	Size Range	A	B	C	D	E	F	G	H
AA	1/4	1 - 1-3/8	0.150	0.250	0.325	0.065	1/64 - 1/32	0.075	7/16	1/8
A	3/16	31/32 - 1-3/8	0.150	0.250	0.325	0.065	1/64 - 1/32	0.075	7/16	1/8
B	9/32	1-1/4 - 1-3/4	0.200	0.250	0.350	0.070	1/64 - 1/32	0.075	1/2	1/8
C	5/16	1-1/2 - 2-3/8	0.200	0.250	0.350	0.080	1/32 - 3/64	0.075	5/8	1/8
D	3/8	2 - 2-7/8	0.300	0.375	0.525	0.100	1/32 - 3/64	0.129	7/8	3/16
E	7/16	2-1/2 - 3-3/8	0.300	0.375	0.525	0.100	1/32 - 1/16	0.129	1-1/8	3/16
F	1/2	3 - 3-7/8	0.300	0.500	0.650	0.125	1/32 - 1/16	0.156	1-1/4	1/4
G	5/8	3-1/2 - 4-1/2	0.400	0.500	0.700	0.140	1/32 - 1/16	0.156	1-1/2	1/4
H ¹ - H ²	11/16	4 - 5	0.500	0.500	0.750	0.165	1/32 - 1/16	0.156	1-1/2	1/4

NOTE: Grind cutting edge 0.005" above center line at the center of the new tool

NOTE: Maintain flatness and height across the cutting edges of the tool within 0.001" T.I.R.

Recommended Cutting Data | Imperial (inch)

High Performance Spade Inserts

ISO	Material	Hardness (BHN)	 TiN SFM	 TiAlN SFM	 TiCN SFM	Feed Rate (IPR) by Diameter			
						1 - 1-1/4	1-1/4 - 2	2 - 3	3 - 5
P	Free Machining Steel 1118, 1215, 12L14, etc.	100 - 150	200	280	260	.016	.020	.023	0.28
		150 - 200	180	260	235	.016	.020	.023	.028
		200 - 250	160	240	210	.016	.020	.023	.028
P	Low Carbon Steel 1010, 1020, 1025, 1522, 1144, etc.	85 - 125	170	250	220	.015	.019	.023	.027
		125 - 175	160	240	210	.015	.019	.023	.027
		175 - 225	150	225	195	.014	.018	.021	.024
		225 - 275	140	210	180	.014	.018	.021	.024
P	Medium Carbon Steel 1030, 1040, 1050, 1527, 1140, 1151, etc.	125 - 175	160	240	210	.015	.019	.023	.027
		175 - 225	150	225	195	.014	.018	.021	.024
		225 - 275	140	210	180	.014	.018	.021	.024
		275 - 325	130	195	170	.012	.016	.019	.022
P	Alloy Steel 4140, 5140, 8640, etc.	125 - 175	150	210	195	.014	.017	.019	.022
		175 - 225	140	195	180	.014	.017	.019	.022
		225 - 275	130	180	170	.014	.017	.019	.022
		275 - 325	120	170	155	.012	.015	.017	.020
		325 - 375	110	155	145	.012	.015	.017	.020
P	High Strength Alloy 4340, 4330V, 300M, etc.	225 - 300	80	110	100	.010	.014	.017	.020
		300 - 350	60	85	80	.010	.014	.017	.020
		350 - 400	50	70	65	.009	.012	.015	.018
P	Structural Steel A36, A285, A516, etc.	100 - 150	140	200	180	.014	.018	.021	.026
		150 - 250	120	170	155	.012	.016	.019	.024
		250 - 350	100	140	130	.010	.014	.017	.020
P	Tool Steel H-13, H-21, A-4, O-2, S-3, etc.	150 - 200	80	110	105	.010	.012	.015	.017
		200 - 250	60	90	85	.010	.012	.015	.017
S	High Temp Alloy Hastelloy B, Inconel 600, etc.	140 - 220	30	40	35	.010	.012	.015	-
		220 - 310	25	35	30	.008	.010	.012	-
M	Stainless Steel 303, 416, 420, 17-4 PH, etc.	135 - 185	75	105	95	.011	.014	.016	.020
		185 - 275	60	90	80	.010	.012	.014	.018
K	Cast Iron	120 - 150	170	250	220	.020	.024	.027	.030
		150 - 200	150	225	195	.018	.022	.025	.028
		200 - 220	130	195	170	.016	.018	.021	.024
		220 - 260	110	165	145	.012	.014	.017	.020
		260 - 320	90	135	120	.009	.012	.014	.016
N	Aluminum	30	600	850	750	.020	.022	.025	.025
		180	300	450	400	.018	.022	.025	.025

Deep Hole Drilling Speed and Feed Adjustment

	Holder Length	
	Long	XL
Speed	0.90	0.80
Feed	-	0.90

Recommended Speed and Feed Example

If the recommended speed and feed is 200 SFM and 0.016 IPR for a standard length holder, then the speed and feed using an XL holder in the same application would be 160 SFM and 0.014 IPR.

$200 \cdot 0.80 = 160 \text{ SFM}$	$0.016 \cdot 0.90 = 0.014 \text{ IPR}$
------------------------------------	--

⚠ WARNING Tool failure can cause serious injury. To prevent:

- When using holders without support bushing, use a short length holder to establish an initial hole that is a minimum of 2 diameters deep.
- Do not rotate tool holders more than 50 RPM unless it is engaged with the workpiece or fixture.

Refer to page A40: 48 for Deep Hole Drilling Guidelines. Visit www.alliedmachine.com/DeepHoleGuidelines for the most up-to-date information and procedures. Factory technical assistance is available for your specific applications through our Application Engineering Team.

IMPORTANT: The speeds and feeds listed above are a general starting point for all applications. Refer to the Coolant Recommendation chart for coolant requirements to run at the recommended speeds and feeds. Factory technical assistance is available through our Application Engineering department. See adjustment examples on the following page.

Coolant Recommendations | Imperial (inch)

High Performance Spade Inserts

ISO	Material	Data Metrics	Data by Diameter			
			1 - 1-1/4	1-1/4 - 2	2 - 3	3 - 5
P	Free Machining Steel 1118, 1215, 12L14, etc.	Hardness (BHN)	100 - 250	100 - 250	100 - 250	100 - 250
		Coolant Pressure (PSI)	105 - 150	55 - 75	45 - 60	35 - 45
		Coolant Volumetric Flow Rate (GPM)	6.3 - 7.6	15 - 18	31 - 36	47 - 53
	Low Carbon Steel	Hardness (BHN)	85 - 275	85 - 275	85 - 275	85 - 275
		Coolant Pressure (PSI)	80 - 115	45 - 55	35 - 45	30 - 35
		Coolant Volumetric Flow Rate (GPM)	5.5 - 6.6	14 - 15	28 - 31	43 - 46
	Medium Carbon Steel	Hardness (BHN)	125 - 325	125 - 325	125 - 325	125 - 325
		Coolant Pressure (PSI)	70 - 100	40 - 50	35 - 40	30 - 35
		Coolant Volumetric Flow Rate (GPM)	5.2 - 6.2	13 - 15	28 - 30	43 - 46
	Alloy Steel	Hardness (BHN)	125 - 375	125 - 375	125 - 375	125 - 375
		Coolant Pressure (PSI)	60 - 85	30 - 40	30 - 35	25 - 30
		Coolant Volumetric Flow Rate (GPM)	4.8 - 5.7	11 - 13	26 - 28	39 - 43
	High Strength Alloy 4340, 4330V, 300M, etc.	Hardness (BHN)	225 - 400	225 - 400	225 - 400	225 - 400
		Coolant Pressure (PSI)	25 - 30	20 - 25	20 - 25	20 - 25
		Coolant Volumetric Flow Rate (GPM)	3.1 - 3.4	9 - 10	21 - 23	35 - 39
	Structural Steel A36, A285, A516, etc.	Hardness (BHN)	100 - 350	100 - 350	100 - 350	100 - 350
		Coolant Pressure (PSI)	50 - 70	30 - 35	25 - 30	25 - 30
		Coolant Volumetric Flow Rate (GPM)	4.4 - 5.2	11 - 12	23 - 26	39 - 43
Tool Steel H-13, H-21, A-4, O-2, S-3, etc.	Hardness (BHN)	150 - 250	150 - 250	150 - 250	150 - 250	
	Coolant Pressure (PSI)	25 - 30	20 - 25	20 - 25	20 - 25	
	Coolant Volumetric Flow Rate (GPM)	3.1 - 3.4	9 - 10	21 - 23	35 - 43	
S	High Temp Alloy Hastelloy B, Inconel 600, etc.	Hardness (BHN)	140 - 310	140 - 310	140 - 310	140 - 310
		Coolant Pressure (PSI)	35 - 40	25 - 30	25 - 30	-
		Coolant Volumetric Flow Rate (GPM)	3.6 - 3.9	10 - 11	23 - 26	-
M	Stainless Steel 303, 416, 420, 17-4 PH, etc.	Hardness (BHN)	135 - 275	135 - 275	135 - 275	135 - 275
		Coolant Pressure (PSI)	50 - 65	30 - 35	25 - 30	25 - 30
		Coolant Volumetric Flow Rate (GPM)	4.4 - 5.0	11 - 12	23 - 26	39 - 43
K	Cast Iron	Hardness (BHN)	120 - 320	120 - 320	120 - 320	120 - 320
		Coolant Pressure (PSI)	40 - 50	25 - 30	25 - 30	20 - 25
		Coolant Volumetric Flow Rate (GPM)	3.9 - 4.4	10 - 11	23 - 26	35 - 43
N	Aluminum	Hardness (BHN)	30 - 180	30 - 180	30 - 180	30 - 180
		Coolant Pressure (PSI)	150 - 220	80 - 115	60 - 80	55 - 70
		Coolant Volumetric Flow Rate (GPM)	7.6 - 9.1	19 - 22	36 - 42	59 - 66

Deep Hole Drilling Speed and Feed Adjustment

Pressure and Flow	Holder Length	
	Long	XL
	1.3	2

Recommended Speed and Feed Example

If the recommended pressure and flow is 150 PSI and 6.3 GPM for a standard length holder, then the adjusted pressure and flow using an XL holder in the same application would be 300 PSI and 12.6 GPM.

$150 \cdot 2 = 300 \text{ PSI}$	$6.3 \cdot 2 = 12.6 \text{ GPM}$
---------------------------------	----------------------------------

⚠ WARNING Tool failure can cause serious injury. To prevent:

- When using holders without support bushing, use a short length holder to establish an initial hole that is a minimum of 2 diameters deep.
- Do not rotate tool holders more than 50 RPM unless it is engaged with the workpiece or fixture.

Refer to page A40: 48 for Deep Hole Drilling Guidelines. Visit www.alliedmachine.com/DeepHoleGuidelines for the most up-to-date information and procedures. Factory technical assistance is available for your specific applications through our Application Engineering Team.

IMPORTANT: The coolant pressure and flow rate recommendation below represents a good approximation to obtain optimum tool life and chip evacuation at the recommended speeds and feeds. If lower coolant capabilities exist in a drilling application, the HP/Universal drilling system will still function at reduced penetration rates. Contact our Application Engineering department for more specific recommendations of coolant requirements and/or speeds and feeds.

A
DRILLING
B
BORING
C
REAMING
D
BURNISHING
E
THREADING
X
SPECIALS

Recommended Cutting Data | Imperial (inch)

Universal Spade Inserts

ISO	Material	Hardness (BHN)	SFM	Feed Rate (IPR) by Diameter			
				1 - 1-1/4	1-1/4 - 2	2 - 3	3 - 5
P	Free Machining Steel 1118, 1215, 12L14, etc.	100 - 150	100	.014	.016	.020	.024
		150 - 200	90	.013	.015	.019	.022
		200 - 250	80	.012	.014	.018	.020
	Low Carbon Steel 1010, 1020, 1025, 1522, 1144, etc.	85 - 125	80	.012	.015	.018	.020
		125 - 175	75	.012	.014	.017	.020
		175 - 225	60	.010	.014	.016	.018
		225 - 275	55	.010	.013	.016	.018
	Medium Carbon Steel 1030, 1040, 1050, 1527, 1140, 1151, etc.	125 - 175	65	.010	.014	.018	.020
		175 - 225	60	.010	.014	.016	.020
		225 - 275	50	.008	.013	.016	.018
		275 - 325	45	.008	.012	.014	.016
	Alloy Steel 4140, 5140, 8640, etc.	125 - 175	60	.010	.014	.018	.020
175 - 225		55	.010	.014	.016	.020	
225 - 275		45	.008	.013	.016	.018	
275 - 325		35	.008	.012	.014	.016	
High Strength Alloy 4340, 4330V, 300M, etc.	225 - 300	40	.008	.012	.014	.016	
	300 - 350	30	.006	.010	.014	.016	
	350 - 400	25	.006	.008	.014	.016	
Structural Steel A36, A285, A516, etc.	100 - 150	70	.012	.016	.018	.020	
	150 - 250	60	.010	.014	.016	.018	
	250 - 350	50	.008	.012	.014	.016	
Tool Steel H-13, H-21, A-4, O-2, S-3, etc.	150 - 200	50	.009	.011	.014	.016	
	200 - 250	40	.008	.010	.013	.015	
S	High Temp Alloy Hastelloy B, Inconel 600, etc.	140 - 220	20	.008	.010	.012	-
		220 - 310	15	.007	.009	.011	-
M	Stainless Steel 303, 416, 420, 17-4 PH, etc.	135 - 185	45	.008	.012	.015	.018
		185 - 275	35	.007	.010	.013	.016
K	Cast Iron	120 - 150	100	.016	.020	.022	.025
		150 - 200	80	.015	.018	.020	.022
		200 - 220	70	.011	.014	.018	.020
		220 - 260	60	.008	.012	.015	.017
		260 - 320	45	.008	.010	.012	.014
N	Aluminum	30	275	.018	.026	.032	.042
		180	200	.018	.026	.032	.042

Deep Hole Drilling Speed and Feed Adjustment

	Holder Length	
	Long	XL
Speed	0.90	0.80
Feed	-	0.90

Recommended Speed and Feed Example

If the recommended speed and feed is 100 SFM and 0.016 IPR for a standard length holder, then the speed and feed using an XL holder in the same application would be 80 SFM and 0.014 IPR.

$100 \cdot 0.80 = 80 \text{ SFM}$	$0.016 \cdot 0.90 = 0.014 \text{ IPR}$
-----------------------------------	--

1. WARNING Tool failure can cause serious injury. To prevent:

- When using holders without support bushing, use a short length holder to establish an initial hole that is a minimum of 2 diameters deep.
- Do not rotate tool holders more than 50 RPM unless it is engaged with the workpiece or fixture.

Refer to page A40: 48 for Deep Hole Drilling Guidelines. Visit www.alliedmachine.com/DeepHoleGuidelines for the most up-to-date information and procedures. Factory technical assistance is available for your specific applications through our Application Engineering Team.

IMPORTANT: The speeds and feeds listed above are a general starting point for all applications. Refer to the Coolant Recommendation chart for coolant requirements to run at the recommended speeds and feeds. Factory technical assistance is available through our Application Engineering department. See adjustment examples on the following page.

Coolant Recommendations | Imperial (inch)

Universal Spade Inserts

ISO	Material	Data Metrics	Data by Diameter			
			1 - 1-1/4	1-1/4 - 2	2 - 3	3 - 5
P	Free Machining Steel 1118, 1215, 12L14, etc.	Hardness (BHN)	100 - 250	100 - 250	100 - 250	100 - 250
		Coolant Pressure (PSI)	40	25	25	20
		Coolant Volumetric Flow Rate (GPM)	3.9	10	23	35
	Low Carbon Steel	Hardness (BHN)	85 - 275	85 - 275	85 - 275	85 - 275
		Coolant Pressure (PSI)	30	20	20	20
		Coolant Volumetric Flow Rate (GPM)	3.4	9	21	35
	Medium Carbon Steel	Hardness (BHN)	125 - 325	125 - 325	125 - 325	125 - 325
		Coolant Pressure (PSI)	25	20	20	20
		Coolant Volumetric Flow Rate (GPM)	3.1	9	21	35
	Alloy Steel	Hardness (BHN)	125 - 375	125 - 375	125 - 375	125 - 375
		Coolant Pressure (PSI)	20	20	20	20
		Coolant Volumetric Flow Rate (GPM)	2.8	9	21	35
	High Strength Alloy 4340, 4330V, 300M, etc.	Hardness (BHN)	225 - 400	225 - 400	225 - 400	225 - 400
		Coolant Pressure (PSI)	25	20	20	20
		Coolant Volumetric Flow Rate (GPM)	3.1	9	21	35
	Structural Steel A36, A285, A516, etc.	Hardness (BHN)	100 - 350	100 - 350	100 - 350	100 - 350
		Coolant Pressure (PSI)	25	20	20	20
		Coolant Volumetric Flow Rate (GPM)	3.1	9	21	35
Tool Steel H-13, H-21, A-4, O-2, S-3, etc.	Hardness (BHN)	150 - 250	150 - 250	150 - 250	150 - 250	
	Coolant Pressure (PSI)	25	20	20	20	
	Coolant Volumetric Flow Rate (GPM)	3.1	9	21	35	
S	High Temp Alloy Hastelloy B, Inconel 600, etc.	Hardness (BHN)	140 - 310	140 - 310	140 - 310	140 - 310
		Coolant Pressure (PSI)	25	20	20	20
		Coolant Volumetric Flow Rate (GPM)	3.1	9	21	35
M	Stainless Steel 303, 416, 420, 17-4 PH, etc.	Hardness (BHN)	135 - 275	135 - 275	135 - 275	135 - 275
		Coolant Pressure (PSI)	25	25	20	20
		Coolant Volumetric Flow Rate (GPM)	3.1	10	21	35
K	Cast Iron	Hardness (BHN)	120 - 320	120 - 320	120 - 320	120 - 320
		Coolant Pressure (PSI)	25	20	20	20
		Coolant Volumetric Flow Rate (GPM)	3.1	9	21	35
N	Aluminum	Hardness (BHN)	30 - 180	30 - 180	30 - 180	30 - 180
		Coolant Pressure (PSI)	55	35	30	30
		Coolant Volumetric Flow Rate (GPM)	4.6	12	26	40

Deep Hole Drilling Speed and Feed Adjustment

	Holder Length	
	Long	XL
Pressure and Flow	1.3	2

Recommended Speed and Feed Example

If the recommended pressure and flow is 150 PSI and 6.3 GPM for a standard length holder, then the adjusted pressure and flow using an XL holder in the same application would be 300 PSI and 12.6 GPM.

$150 \cdot 2 = 300 \text{ PSI}$	$6.3 \cdot 2 = 12.6 \text{ GPM}$
---------------------------------	----------------------------------

⚠ WARNING Tool failure can cause serious injury. To prevent:

- When using holders without support bushing, use a short length holder to establish an initial hole that is a minimum of 2 diameters deep.
- Do not rotate tool holders more than 50 RPM unless it is engaged with the workpiece or fixture.

Refer to page A40: 48 for Deep Hole Drilling Guidelines. Visit www.alliedmachine.com/DeepHoleGuidelines for the most up-to-date information and procedures. Factory technical assistance is available for your specific applications through our Application Engineering Team.

IMPORTANT: The coolant pressure and flow rate recommendation below represents a good approximation to obtain optimum tool life and chip evacuation at the recommended speeds and feeds. If lower coolant capabilities exist in a drilling application, the HP/Universal drilling system will still function at reduced penetration rates. Contact our Application Engineering department for more specific recommendations of coolant requirements and/or speeds and feeds.

A
DRILLING
B
BORING
C
REAMING
D
BURNISHING
E
THREADING
X
SPECIALS



Deep Hole Drilling Guidelines

A

DRILLING

- 1. Pilot Hole**
100% RPM
100% IPR (mm/rev)

Establish the pilot hole using the same diameter short drill to a depth of 2xD minimum. Utilize a pilot drill with the same or larger included point angle.

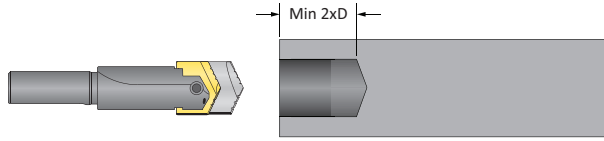

Coolant ON

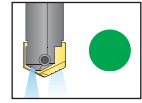

B

BORING

- 2. Feed-in**
50 RPM max
12 IPM (300 mm/min)

Feed the longer drill within 1/16" (1.5mm) short of the established pilot hole bottom at a **maximum of 50 RPM** and 12 IPM (300 mm/min) feed rate.

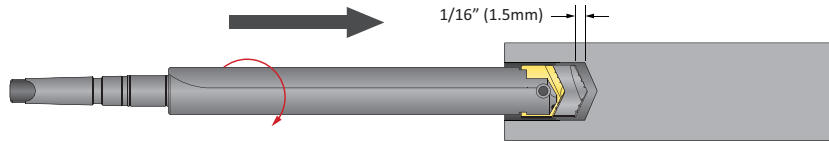

Coolant OFF

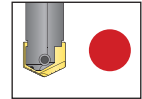

C

REAMING

- 3. Deep Hole Transition Drilling**
50% RPM
75% IPR (mm/rev)

Drill additional 1xD past the bottom of the pilot hole at 50% reduction of recommended speed and 25% reduction of recommended feed. Minimum of 1 second dwell is required to meet full speed before feeding.

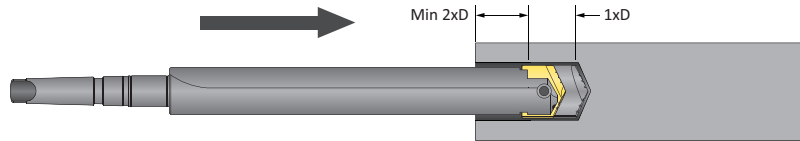

Coolant ON

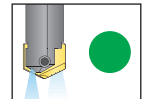

D

BURNISHING

- 4. Deep Hole Drilling - Blind**
100% RPM
100% IPR (mm/rev)

Drill to full depth at recommended speed and feed for longer drill according to Allied speed and feed charts. **No peck cycle recommended.**

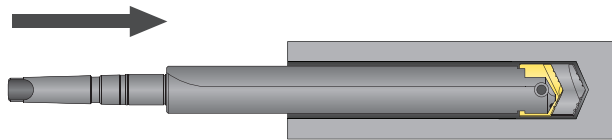

Coolant ON

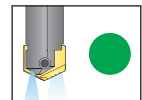

E

THREADING

- 6. Drill Retract**
50 RPM max

Reduce speed to a **maximum of 50 RPM** before retracting from the hole.

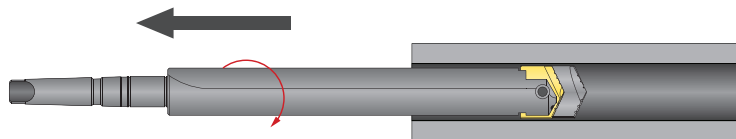

Coolant OFF

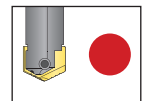

X

SPECIALS

1. WARNING Tool failure can cause serious injury. To prevent:

- When using holders without support bushing, use a short length holder to establish an initial hole that is a minimum of 2 diameters deep.
- Do not rotate tool holders more than 50 RPM unless it is engaged with the workpiece or fixture.

Visit www.alliedmachine.com/DeepHoleGuidelines for the most up-to-date information and procedures. Factory technical assistance is available for your specific applications through our Application Engineering Team.

This page left intentionally blank

A

DRILLING

B

BORING

C

REAMING

D

BURNISHING

E

THREADING

X

SPECIALS

APX Drill

Deep Hole / Large Diameter Drilling System

▶ **Diameter Range:** 1.4961" - 4.0000" (38.00mm - 101.60mm)



Don't Let Your Machine Slow You Down

The APX deep hole/large diameter drilling system delivers the strength and versatility needed for any deep hole drilling application. The breakthrough geometry is designed to increase penetration rates and tool life. By allowing for higher spindle speeds, the APX lets you take advantage of the power curve on modern CNC machines.

Excellent chip control	Improves hole quality and surface finish	Provides maximum durability and stability
------------------------	--	---

Applicable Industries

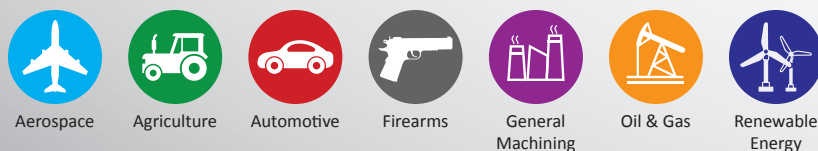

Your safety and the safety of others is very important. This catalog contains important safety messages. Always read and follow all safety precautions.



This triangle is a safety hazard symbol. It alerts you to potential safety hazards that can cause tool failure and serious injury.

When you see this symbol in the catalog, look for a related safety message that may be near this triangle or referred to in the nearby text.

There are safety signal words also used in the catalog. Safety messages follow these words.

WARNING

WARNING (shown above) means that failure to follow the precautions in this message could result in tool failure and serious injury.

NOTICE means that failure to follow the precautions in this message could result in damage to the tool or machine but not result in personal injury.

NOTE and **IMPORTANT** are also used. These are important that you read and follow but are not safety-related.

Visit www.alliedmachine.com for the most up-to-date information and procedures.

Reference Icons

The following icons will appear throughout the catalog to help you navigate between products.



Setup / Assembly Information

Detailed instructions and information regarding the corresponding part(s)

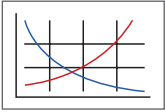

Recommended Cutting Data

Speed and feed recommendations for optimum and safe drilling

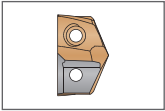

GEN3SYS® Pilot Inserts

Lists the GEN3SYS XT pilot insert options for each APX Drill series

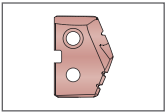

T-A® Pilot Inserts

Lists the Original T-A® and GEN2 T-A® pilot insert options for each APX Drill series

Series	Diameter Range	
	Imperial (inch)	Metric (mm)
33	1.2992 - 1.4688	33.00 - 37.99
38	1.4961 - 1.7322	38.00 - 43.99
44	1.7323 - 2.0075	44.00 - 50.99
51	2.0076 - 2.2438	51.00 - 56.99
57	2.2439 - 2.4799	57.00 - 62.99
63	2.4800 - 2.7555	63.00 - 69.99
70	2.7556 - 2.9917	70.00 - 75.99
76	2.9918 - 3.2673	76.00 - 82.99
83	3.2674 - 3.5035	83.00 - 88.99
89	3.5036 - 3.7400	89.00 - 94.99
95	3.7401 - 4.0000	95.00 - 101.60

Introduction Information

Drill Selection Guide / Assembly Details 2 - 3
 Pilot Insert Options / Details 4
 Product Nomenclature 5

















Drill Series

33 Series 6 - 7
 38 Series 8 - 9
 44 Series 10 - 11
 51 Series 12 - 13
 57 Series 14 - 15
 63 Series 16 - 17
 70 Series 18 - 19
 76 Series 20 - 21
 83 Series 22 - 23
 89 Series 24 - 25
 95 Series 26 - 27

Recommended Cutting Data

Imperial (inch) 28
 Metric (mm) 29
 Deep Hole Drilling Guidelines 30



Drill Selection Guide

Series	33	38	44	51	57
					
Page	6 - 7	8 - 9	10 - 11	12 - 13	14 - 15
D ₅ inch	1.2992 - 1.4960	1.4961 - 1.7322	1.7323 - 2.0075	2.0076 - 2.2438	2.2439 - 2.4799
D ₅ mm	33.00 - 37.99	38.00 - 43.99	44.00 - 50.99	51.00 - 56.99	57.00 - 62.99
ISO Material					
IC Insert Shape					
IC Insert Size	5/16	3/8"	3/8", 1/2"	1/2", 9/16"	9/16"
Wear Pads	NO	NO	NO	NO	NO
Holders					
Drill Depth (inch)	4-7/16 - 14-29/32	5-1/8 - 17-1/4	6 - 20-1/8	6-3/8 - 22-3/8	7-1/8 - 24-3/4
Drill Depth (mm)	112.6 - 378.6	130.5 - 439.9	151.5 - 510.0	161.8 - 570.0	179.9 - 626.9
Pilot Insert					
T-A Series	0, 1	0, 1	1	1	1, 2
GEN3SYS XT Series	16, 18, 20	15, 17, 18, 20	17, 18, 22	18, 20, 22	22, 24, 26



T-A® Style Pilot Insert Head

- Utilizes both Original T-A® and GEN2 T-A® inserts (0 - 2 series)
- Multiple geometry options are available to achieve optimal results in different types of applications





GEN2 T-A Pilot Inserts
Original T-A Pilot Inserts



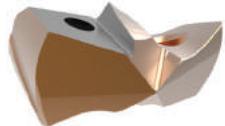

GEN3SYS® XT Style Pilot Insert Head

- Utilizes GEN3SYS® XT inserts (15 - 32 series)
- Multiple geometry options are available to achieve optimal results in different types of applications



GEN3SYS XT Pilot Inserts

Flanged Straight Shank
CAT40 / CAT50 Integral Shank

63	70	76	83	89	95
					
16 - 17	18 - 19	20 - 21	22 - 23	24 - 25	26 - 27
2.4800 - 2.7555	2.7556 - 2.9917	2.9918 - 3.2673	3.2674 - 3.5035	3.5036 - 3.7400	3.7401 - 4.0000
63.00 - 69.99	70.00 - 75.99	76.00 - 82.99	83.00 - 88.99	89.00 - 94.99	95.00 - 101.60
					
					
9/16"	3/8"	1/2"	1/2"	9/16"	9/16"
NO	YES	YES	YES	YES	YES
7-7/8 - 27-1/8	8-3/4 - 27-7/8	9-1/2 - 26-1/8	10-1/8 - 27-3/4	10-7/8 - 27-5/8	11-7/8 - 27-1/2
200.8 - 688.3	218.8 - 709.4	239.9 - 664.0	257.8 - 704.9	275.8 - 701.8	302.0 - 698.5
2	2	2	2	2	2
26, 29, 32	29	29	32	29	32



Step 1:

Lower the APX head assembly onto the APX holder.



Step 2:

Insert the head mounting screws into points A and B. Tighten until the head is properly secured to the holder.

Step 3:

Tighten with the head mounting driver using the torque setting chart below.

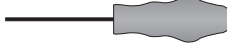
Torque Setting Chart

Series	Screw	Driver	Torque
38 - 63	75020-IP20-1	 8IP-20	60 in-lb (678 N-cm)
70 - 95	78027-IP30-1	 8IP-30B	250 in-lb (2825 N-cm)



Pilot Insert Options

A
DRILLING
B
BORING
C
REAMING
D
BURNISHING
E
THREADING
X
SPECIALS

T-A® Pilot Inserts

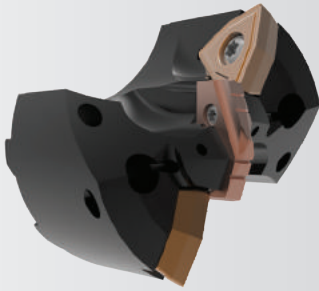

GEN3SYS® XT Pilot Inserts

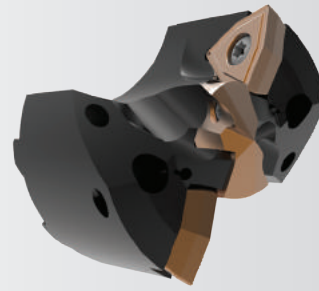

GEN2 T-A Standard

- Designed for rigid machining applications, primarily used for drilling exotic and high alloy materials
- Ideal for general use when the surface speed needs to be increased



Standard Geometry

- Designed with corner and cutting edge enhancements to deliver more reliability, durability, and productivity
- Increases penetration rates and tool life
- Available in C1 or C2 carbide

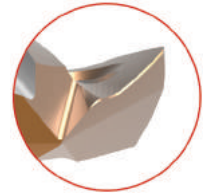

GEN2 T-A High Efficiency (-HE)

- Designed for improved chip formation in elastic materials like low carbon steels
- Maximizes performance and increases value



Cast Iron Geometry (-CI)

- Increases durability and tool life in ductile, nodular, and grey cast irons
- Available in C2 carbide

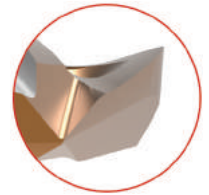

Original T-A Standard

- Excellent choice for general purpose use
- Provides fast penetration rates that produce good hole size and finish
- Combines highly efficient, stable cutting action to minimize power consumption

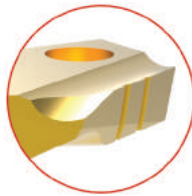

Low Rake Geometry (-LR)

- The toughest XT geometry available
- Designed for harder steels and less than ideal machining applications
- Available in C1 or C2 carbide

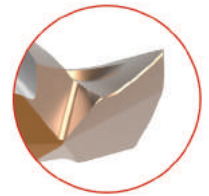

Original T-A Tiny Chip (-TC)

- Unique lip and point design for excellent chip control
- Improved capabilities in long-chipping materials such as low carbon steels and soft alloy steels
- Enhanced performance in lower powered machines for better chip formation at lower feed rates

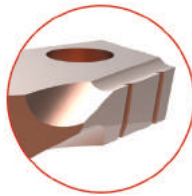

Stainless Steel Geometry (-AS)

- Designed with a specific geometry to provide unmatched chip control and tool life in austenitic and PH stainless steels, as well as high temperature alloys such as Inconel, Hastelloy, and Titanium alloys
- Available in C2 carbide

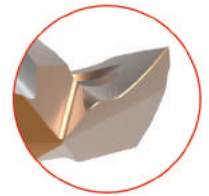

Original T-A High Impact (-HI)

- Designed to enhance chip formation in materials with high elasticity/ductility and poor chip forming characteristics
- SK2 corner preparation for increased tool life
- Improves chip formation in structural, cast, and forged steels



NOTE: For a complete offering of pilot inserts, see sections **A20** (GEN3SYS Drilling Systems) and **A30** (T-A Drilling Systems) of our catalog.

Product Nomenclature

APX Drill Heads

V	38	15	D	-	0116
1	2	3	4		5

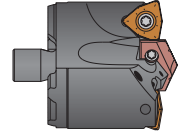

1. APX Head	2. Series	3. Pilot Series																														
V = Head	<table border="0"> <tr> <td>33 = 33 series</td> <td>70 = 70 series</td> </tr> <tr> <td>38 = 38 series</td> <td>76 = 76 series</td> </tr> <tr> <td>44 = 44 series</td> <td>83 = 83 series</td> </tr> <tr> <td>51 = 51 series</td> <td>89 = 89 series</td> </tr> <tr> <td>57 = 57 series</td> <td>95 = 95 series</td> </tr> <tr> <td>63 = 63 series</td> <td></td> </tr> </table>	33 = 33 series	70 = 70 series	38 = 38 series	76 = 76 series	44 = 44 series	83 = 83 series	51 = 51 series	89 = 89 series	57 = 57 series	95 = 95 series	63 = 63 series		<table border="0"> <tr> <th>T-A® Pilot Insert</th> <th colspan="2">GEN3SYS® XT Pilot Insert</th> </tr> <tr> <td>00 = 0 series</td> <td>15 = 15 series</td> <td>24 = 24 series</td> </tr> <tr> <td>01 = 1 series</td> <td>17 = 17 series</td> <td>26 = 26 series</td> </tr> <tr> <td>02 = 2 series</td> <td>18 = 18 series</td> <td>29 = 29 series</td> </tr> <tr> <td></td> <td>20 = 20 series</td> <td>32 = 32 series</td> </tr> <tr> <td></td> <td>22 = 22 series</td> <td></td> </tr> </table>	T-A® Pilot Insert	GEN3SYS® XT Pilot Insert		00 = 0 series	15 = 15 series	24 = 24 series	01 = 1 series	17 = 17 series	26 = 26 series	02 = 2 series	18 = 18 series	29 = 29 series		20 = 20 series	32 = 32 series		22 = 22 series	
33 = 33 series	70 = 70 series																															
38 = 38 series	76 = 76 series																															
44 = 44 series	83 = 83 series																															
51 = 51 series	89 = 89 series																															
57 = 57 series	95 = 95 series																															
63 = 63 series																																
T-A® Pilot Insert	GEN3SYS® XT Pilot Insert																															
00 = 0 series	15 = 15 series	24 = 24 series																														
01 = 1 series	17 = 17 series	26 = 26 series																														
02 = 2 series	18 = 18 series	29 = 29 series																														
	20 = 20 series	32 = 32 series																														
	22 = 22 series																															

4. Effective Cutting	5. Major Diameter
D = Double effective S = Single effective	0116 = Inch 1.5153 = Decimal 68 = Metric

Ordering Non-Stocked Diameters:

Non-stocked diameters are also available. Please refer to the price list for applicable process fees. Follow the ordering examples below:

- Inch: 38 series, T-A (1 series), 1.6790" = **V3801D-1.6790**
- Metric: 38 series, T-A (1 series), 42.15mm = **V3801D-42.15**

APX Drill Holders

W	38	05	H	-	200F
1	2	3	4		5

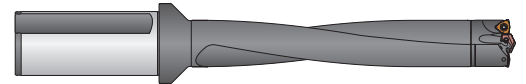

1. APX Holder	2. Series	3. Drill Length	4. Flute Style	5. Shank																						
W = Holder	<table border="0"> <tr> <td>33 = 33 series</td> <td>70 = 70 series</td> </tr> <tr> <td>38 = 38 series</td> <td>76 = 76 series</td> </tr> <tr> <td>44 = 44 series</td> <td>83 = 83 series</td> </tr> <tr> <td>51 = 51 series</td> <td>89 = 89 series</td> </tr> <tr> <td>57 = 57 series</td> <td>95 = 95 series</td> </tr> <tr> <td>63 = 63 series</td> <td></td> </tr> </table>	33 = 33 series	70 = 70 series	38 = 38 series	76 = 76 series	44 = 44 series	83 = 83 series	51 = 51 series	89 = 89 series	57 = 57 series	95 = 95 series	63 = 63 series		<table border="0"> <tr> <td>03 = 3xD</td> </tr> <tr> <td>05 = 5xD</td> </tr> <tr> <td>08 = 8xD</td> </tr> <tr> <td>10 = 10xD</td> </tr> </table>	03 = 3xD	05 = 5xD	08 = 8xD	10 = 10xD	H = Helical	<table border="0"> <tr> <td>150F = 1-1/2" flanged straight shank</td> </tr> <tr> <td>200F = 2" flanged straight shank</td> </tr> <tr> <td>40FM = 40mm flanged straight shank</td> </tr> <tr> <td>50FM = 50mm flanged straight shank</td> </tr> <tr> <td>CV40 = CAT40 integral shank</td> </tr> <tr> <td>CV50 = CAT50 integral shank</td> </tr> </table>	150F = 1-1/2" flanged straight shank	200F = 2" flanged straight shank	40FM = 40mm flanged straight shank	50FM = 50mm flanged straight shank	CV40 = CAT40 integral shank	CV50 = CAT50 integral shank
33 = 33 series	70 = 70 series																									
38 = 38 series	76 = 76 series																									
44 = 44 series	83 = 83 series																									
51 = 51 series	89 = 89 series																									
57 = 57 series	95 = 95 series																									
63 = 63 series																										
03 = 3xD																										
05 = 5xD																										
08 = 8xD																										
10 = 10xD																										
150F = 1-1/2" flanged straight shank																										
200F = 2" flanged straight shank																										
40FM = 40mm flanged straight shank																										
50FM = 50mm flanged straight shank																										
CV40 = CAT40 integral shank																										
CV50 = CAT50 integral shank																										

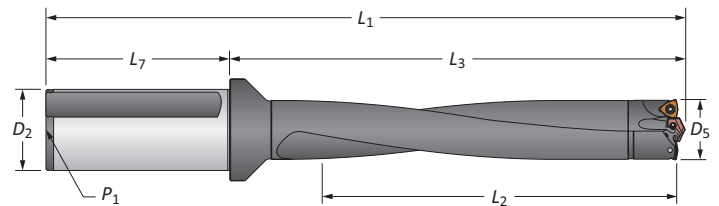
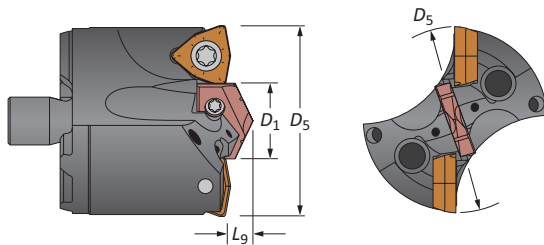

Reference Key

Symbol	Attribute
D ₁	Pilot insert diameter
D ₅	Major cutting diameter
L ₉	Pilot insert length

Reference Key

Symbol	Attribute	Symbol	Attribute
D ₂	Shank diameter	L ₃	Holder reference length
D ₅	Drill diameter range	L ₇	Shank length
L ₁	Overall length	P ₁	Rear pipe tap
L ₂	Drill depth		



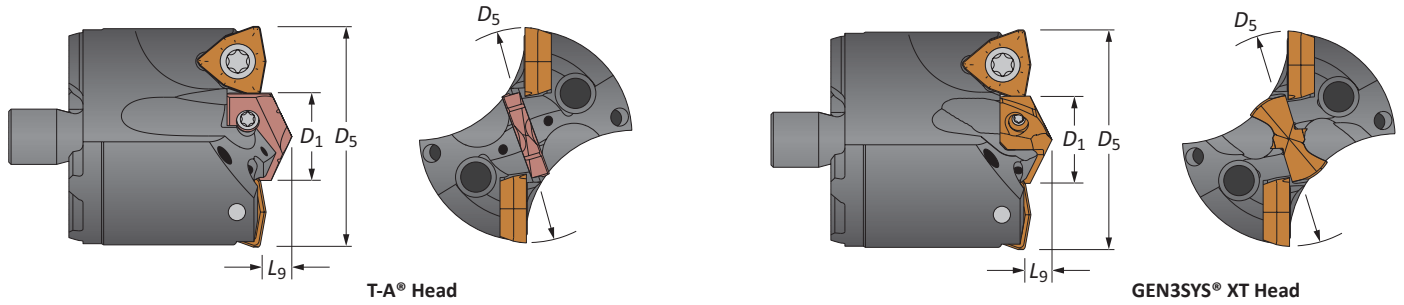

APX Drill Heads

33 Series | Diameter Range: 1.2992" - 1.4688" (33.00mm - 37.99mm)





Heads

Head					T-A Head			GEN3SYS XT Head			IC Insert Size
D_5 fractional	D_5 inch	D_5 mm	D_1	L_9	Part No.	Pilot Series		Part No.	Pilot Series		
-	1.2992	33.00	16	1/4	V3300D-33	0	4C*0H-16	V3316D-33	16	7C*16P-16	5/16
1-5/16	1.3125	33.34	16	1/4	V3300D-0110	0	4C*0H-16	V3316D-0110	16	7C*16P-16	5/16
-	1.3386	34.00	18	1/4	V3301D-34	1	4C*1H-18	V3318D-34	18	7C*18P-18	5/16
1-11/32	1.3438	34.13	18	1/4	V3301D-0111	1	4C*1H-18	V3318D-0111	18	7C*18P-18	5/16
1-3/8	1.3750	34.93	18	1/4	V3301D-0112	1	4C*1H-18	V3318D-0112	18	7C*18P-18	5/16
-	1.3780	35.00	18	1/4	V3301D-35	1	4C*1H-18	V3318D-35	18	7C*18P-18	5/16
1-13/32	1.4063	35.72	18	1/4	V3301D-0113	1	4C*1H-18	V3318D-0113	18	7C*18P-18	5/16
-	1.4173	36.00	20	1/4	V3301D-36	1	4C*1H-20	V3320D-36	20	7C*20P-20	5/16
1-7/16	1.4375	36.51	20	1/4	V3301D-0114	1	4C*1H-20	V3320D-0114	20	7C*20P-20	5/16
-	1.4567	37.00	20	1/4	V3301D-37	1	4C*1H-20	V3320D-37	20	7C*20P-20	5/16
1-15/32	1.4688	37.31	20	1/4	V3301D-0115	1	4C*1H-20	V3320D-0115	20	7C*20P-20	5/16



*Denotes carbide grade (1 = C1, 2 = C2)

IC Inserts

Coating	Size	Grade	Geometry	 Part No.	 Insert Screw	 Insert Driver	Admissible Tightening Torque*
AM300®	5/16	C5	Standard	OP-05T308-PW	IS-10-1	8IP-10	27.0 in-lbs (305 N-cm)
AM300®	5/16	C1	Standard	OP-05T308-1PW	IS-10-1	8IP-10	27.0 in-lbs (305 N-cm)
AM300®	5/16	C5	High Rake	OP-05T308-PWHR	IS-10-1	8IP-10	27.0 in-lbs (305 N-cm)

*Tightening torques are calculated with a friction coefficient of $\mu = 0.14$ and develop 90% of ultimate yield strength

Pilot Accessories

Pilot Style	Series	 Insert Screws	 Insert Driver	Admissible Tightening Torque*
T-A	0	72567-IP8-1	8IP-8	15.5 in-lbs (175 N-cm)
T-A	1	7375-IP9-1	8IP-9	27.0 in-lbs (305 N-cm)
GEN3SYS	16	72556-IP8-1	8IP-8	15.5 in-lbs (175 N-cm)
GEN3SYS	18	7375-IP9-1	8IP-9	27.0 in-lbs (305 N-cm)
GEN3SYS	20	7375-IP9-1	8IP-9	27.0 in-lbs (305 N-cm)

*Tightening torques are calculated with a friction coefficient of $\mu = 0.14$ and develop 90% of ultimate yield strength

A50: 28 - 29

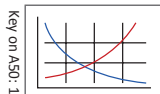

A50: 2 - 5



Section A20

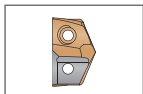

Section A30

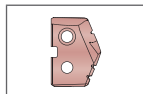

Non-stocked diameters are also available. Follow the examples shown below.

Inch	38 series, T-A (1 series), 1.6790"	Part No. = V3801D-1.6790
Metric	38 series, T-A (1 series), 42.15mm	Part No. = V3801D-42.15

IC inserts sold in multiples of 2 | Insert screws sold in multiples of 10



APX Drill Holders

33 Series | Diameter Range: 1.2992" - 1.4688" (33.00mm - 37.99mm)

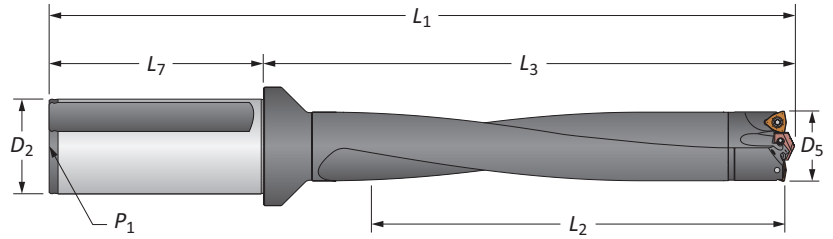

Straight Shank

	Length	D ₅	Body			Shank			Part No.
			L ₂	L ₃	L ₁	L ₇	D ₂	P ₁	
i	3xD	1.2992 - 1.4960	4-7/16	6-19/32	9-9/32	2-11/16	1-1/2	1/4	W3303H-150F
	5xD	1.2992 - 1.4960	7-27/64	9-37/64	12-9/32	2-11/16	1-1/2	1/4	W3305H-150F
	8xD	1.2992 - 1.4960	11-59/64	14-5/64	16-3/4	2-11/16	1-1/2	1/4	W3308H-150F
	10xD	1.2992 - 1.4960	14-29/32	17-1/16	19-3/4	2-11/16	1-1/2	1/4	W3310H-150F
m	3xD	33.00 - 37.99	112.6	167.4	237.4	70.0	40.0	1/4*	W3303H-40FM
	5xD	33.00 - 37.99	188.6	243.4	313.4	70.0	40.0	1/4*	W3305H-40FM
	8xD	33.00 - 37.99	302.6	357.4	427.4	70.0	40.0	1/4*	W3308H-40FM
	10xD	33.00 - 37.99	378.6	433.4	503.4	70.0	40.0	1/4*	W3310H-40FM

*Thread to BSP and ISO 7-1

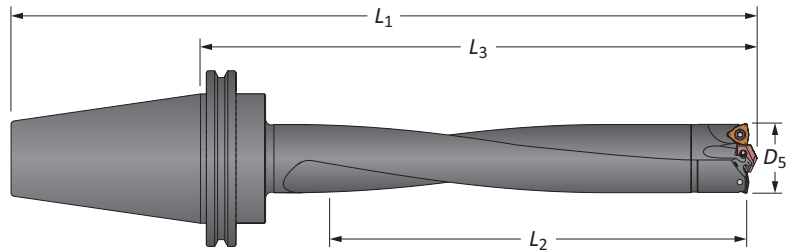

CAT Integral Shank

	Length	D ₅		Body			Shank	Part No.
		inch	mm	L ₂	L ₃	L ₁		
i	3xD	1.2992 - 1.4960	33.00 - 37.99	4-7/16	7-3/8	10-3/16	CV40	W3303H-CV40
	5xD	1.2992 - 1.4960	33.00 - 37.99	7-27/64	10-23/64	13-11/64	CV40	W3305H-CV40
	8xD	1.2992 - 1.4960	33.00 - 37.99	11-59/64	14-55/64	17-21/32	CV40	W3308H-CV40
	10xD	1.2992 - 1.4960	33.00 - 37.99	14-29/32	17-27/32	20-21/32	CV40	W3310H-CV40
	3xD	1.2992 - 1.4960	33.00 - 37.99	4-7/16	7-3/8	11-1/2	CV50	W3303H-CV50
	5xD	1.2992 - 1.4960	33.00 - 37.99	7-27/64	10-23/64	14-31/64	CV50	W3305H-CV50
	8xD	1.2992 - 1.4960	33.00 - 37.99	11-59/64	14-55/64	18-31/32	CV50	W3308H-CV50
	10xD	1.2992 - 1.4960	33.00 - 37.99	14-29/32	17-27/32	21-31/32	CV50	W3310H-CV50

Connection Accessories

Mounting Screw	Mounting Screw Driver	Admissible Tightening Torque*
75020-IP20-1	8IP-20	60 in-lb (678 N-cm)

*Tightening torques are calculated with a friction coefficient of $\mu = 0.14$ and develop 90% of ultimate yield strength

WARNING Refer to Speed and Feed charts for recommended adjustments to speeds and feeds. Refer to page A50: 30 for deep hole drilling guidelines in this section of the catalog. Visit www.alliedmachine.com/DeepHoleGuidelines for the most up-to-date information and procedures. Factory technical assistance is available for your specific applications through our Application Engineering Team.

i = Imperial (in)
m = Metric (mm)



Mounting screws sold in multiples of 4

APX Drill Heads

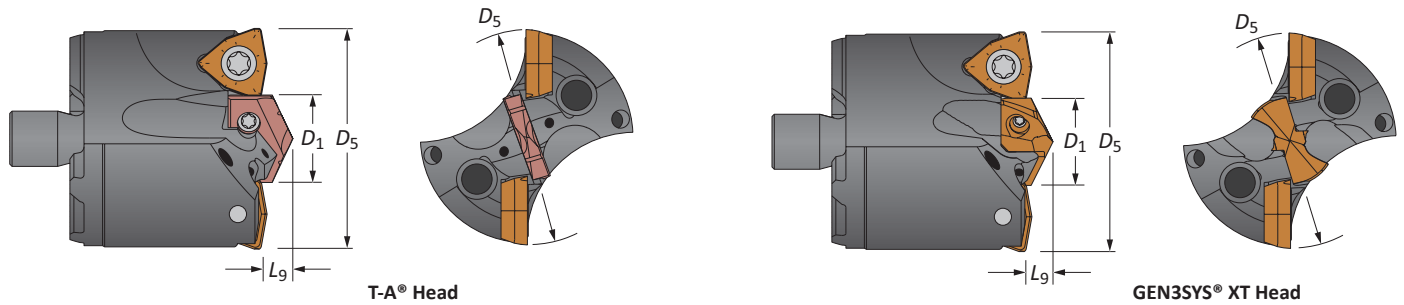
38 Series | Diameter Range: 1.4961" - 1.7322" (38.00mm - 43.99mm)





Heads

Head					T-A Head			GEN3SYS XT Head			IC Insert Size
D ₅ fractional	D ₅ inch	D ₅ mm	D ₁	L ₉	Part No.	Pilot Series		Part No.	Pilot Series		
-	1.4961	38.00	5/8	19/64	V3800D-38	0	4C*0H-0020	V3815D-38	15	7C*15P-0020	3/8
1-1/2	1.5000	38.10	5/8	19/64	V3800D-0116	0	4C*0H-0020	V3815D-0116	15	7C*15P-0020	3/8
1-17/32	1.5313	38.90	5/8	19/64	V3800D-0117	0	4C*0H-0020	V3815D-0117	15	7C*15P-0020	3/8
-	1.5354	39.00	5/8	19/64	V3800D-39	0	4C*0H-0020	V3815D-39	15	7C*15P-0020	3/8
1-9/16	1.5625	39.69	5/8	19/64	V3800D-0118	0	4C*0H-0020	V3815D-0118	15	7C*15P-0020	3/8
-	1.5748	40.00	11/16	19/64	V3800D-40	0	4C*0H-0022	V3817D-40	17	7C*17P-0022	3/8
1-19/32	1.5938	40.48	11/16	19/64	V3800D-0119	0	4C*0H-0022	V3817D-0119	17	7C*17P-0022	3/8
-	1.6142	41.00	11/16	19/64	V3800D-41	0	4C*0H-0022	V3817D-41	17	7C*17P-0022	3/8
1-5/8	1.6250	41.28	11/16	19/64	V3800D-0120	0	4C*0H-0022	V3817D-0120	17	7C*17P-0022	3/8
-	1.6535	42.00	3/4	19/64	V3801D-42	1	4C*0H-0024	V3818D-42	18	7C*18P-0024	3/8
1-21/32	1.6563	42.07	3/4	19/64	V3801D-0121	1	4C*0H-0024	V3818D-0121	18	7C*18P-0024	3/8
1-11/16	1.6875	42.86	3/4	19/64	V3801D-0122	1	4C*0H-0024	V3818D-0122	18	7C*18P-0024	3/8
-	1.6929	43.00	13/16	19/64	V3801D-43	1	4C*0H-0026	V3820D-43	20	7C*20P-0026	3/8
1-23/32	1.7188	43.66	13/16	19/64	V3801D-0123	1	4C*0H-0026	V3820D-0123	20	7C*20P-0026	3/8

*Denotes carbide grade (1 = C1, 2 = C2)

IC Inserts

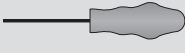
Coating	Size	Grade	Geometry	 Part No.	 Insert Screw	 Insert Driver	Admissible Tightening Torque*
AM300®	3/8	C5	Standard	OP-060408-PW	73595-IP15-1	8IP-15	41.0 in-lbs (465 N-cm)
AM300®	3/8	C1	Standard	OP-060408-1PW	73595-IP15-1	8IP-15	41.0 in-lbs (465 N-cm)
AM300®	3/8	C5	High Rake	OP-060408-PWHR	73595-IP15-1	8IP-15	41.0 in-lbs (465 N-cm)
AM300®	3/8	C5	High Impact	OP-060408-PWHI	73595-IP15-1	8IP-15	41.0 in-lbs (465 N-cm)

*Tightening torques are calculated with a friction coefficient of $\mu = 0.14$ and develop 90% of ultimate yield strength

Pilot Accessories

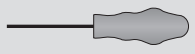
Pilot Style	Series	 Insert Screws	 Insert Driver	Admissible Tightening Torque*
T-A	0	72567-IP8-1	8IP-8	15.5 in-lbs (175 N-cm)
T-A	1	7375-IP9-1	8IP-9	27.0 in-lbs (305 N-cm)
GEN3SYS	15	7247-IP7-1	8IP-7	7.4 in-lbs (84 N-cm)
GEN3SYS	17	72567-IP8-1	8IP-8	15.5 in-lbs (175 N-cm)
GEN3SYS	18	7375-IP9-1	8IP-9	27.0 in-lbs (305 N-cm)
GEN3SYS	20	7375-IP9-1	8IP-9	27.0 in-lbs (305 N-cm)

*Tightening torques are calculated with a friction coefficient of $\mu = 0.14$ and develop 90% of ultimate yield strength

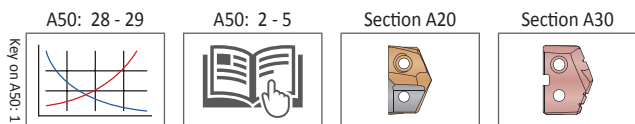

Non-stocked diameters are also available. Follow the examples shown below.

Inch	38 series, T-A (1 series), 1.6790"	Part No. = V3801D-1.6790
Metric	38 series, T-A (1 series), 42.15mm	Part No. = V3801D-42.15

IC inserts sold in multiples of 2 | Insert screws sold in multiples of 10



APX Drill Holders

38 Series | Diameter Range: 1.4961" - 1.7322" (38.00mm - 43.99mm)

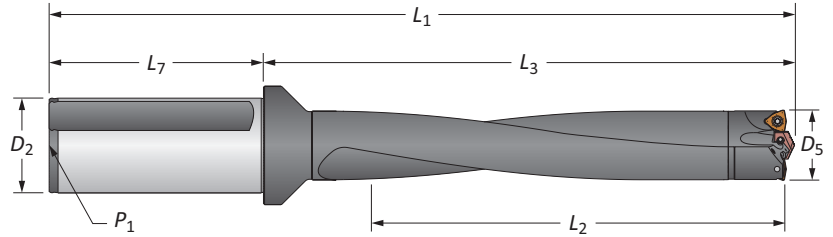

Straight Shank

	Length	D ₅		Body			Shank		Part No.	
		inch	mm	L ₂	L ₃	L ₁	L ₇	D ₂		P ₁
i	3xD	1.4961 - 1.7322	38.00 - 43.99	5-1/8	7-47/64	10-25/64	2-11/16	1-1/2	1/4	W3803H-150F
	5xD	1.4961 - 1.7322	38.00 - 43.99	8-5/8	11-13/64	13-55/64	2-11/16	1-1/2	1/4	W3805H-150F
	8xD	1.4961 - 1.7322	38.00 - 43.99	13-7/8	16-25/64	19-3/64	2-11/16	1-1/2	1/4	W3808H-150F
	10xD	1.4961 - 1.7322	38.00 - 43.99	17-1/4	19-27/32	22-33/64	2-11/16	1-1/2	1/4	W3810H-150F
	3xD	1.4961 - 1.7322	38.00 - 43.99	5-1/8	7-47/64	12-15/64	4-1/2	2	1/4	W3803H-200F
	5xD	1.4961 - 1.7322	38.00 - 43.99	8-5/8	11-13/64	15-45/64	4-1/2	2	1/4	W3805H-200F
	8xD	1.4961 - 1.7322	38.00 - 43.99	13-7/8	16-25/64	20-57/64	4-1/2	2	1/4	W3808H-200F
	10xD	1.4961 - 1.7322	38.00 - 43.99	17-1/4	19-27/32	24-59/64	4-1/2	2	1/4	W3810H-200F
m	3xD	38.00 - 43.99	38.00 - 43.99	130.5	196.5	265.7	70.0	40.0	1/4*	W3803H-40FM
	5xD	38.00 - 43.99	38.00 - 43.99	220.0	284.5	353.7	70.0	40.0	1/4*	W3805H-40FM
	8xD	38.00 - 43.99	38.00 - 43.99	352.0	416.5	485.7	70.0	40.0	1/4*	W3808H-40FM
	10xD	38.00 - 43.99	38.00 - 43.99	439.9	503.9	573.7	70.0	40.0	1/4*	W3810H-40FM
	3xD	38.00 - 43.99	38.00 - 43.99	130.5	196.5	276.5	80.0	50.0	1/4*	W3803H-50FM
	5xD	38.00 - 43.99	38.00 - 43.99	220.0	284.5	364.5	80.0	50.0	1/4*	W3805H-50FM
	8xD	38.00 - 43.99	38.00 - 43.99	352.0	416.5	496.3	80.0	50.0	1/4*	W3808H-50FM
	10xD	38.00 - 43.99	38.00 - 43.99	439.9	503.9	583.9	80.0	50.0	1/4*	W3810H-50FM

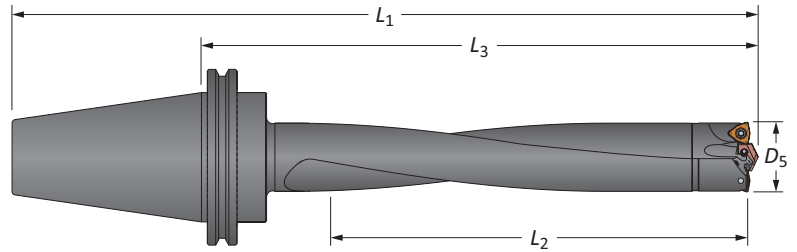

*Thread to BSP and ISO 7-1



CAT Integral Shank

	Length	D ₅		Body			Shank	Part No.
		inch	mm	L ₂	L ₃	L ₁		
i	3xD	1.4961 - 1.7322	38.00 - 43.99	5-1/8	8-5/16	11	CV40	W3803H-CV40
	5xD	1.4961 - 1.7322	38.00 - 43.99	8-5/8	11-49/64	14-29/64	CV40	W3805H-CV40
	8xD	1.4961 - 1.7322	38.00 - 43.99	13-7/8	16-31/32	19-21/32	CV40	W3808H-CV40
	10xD	1.4961 - 1.7322	38.00 - 43.99	17-1/4	20-7/16	23-1/8	CV40	W3810H-CV40
	3xD	1.4961 - 1.7322	38.00 - 43.99	5-1/8	8-5/16	12-5/16	CV50	W3803H-CV50
	5xD	1.4961 - 1.7322	38.00 - 43.99	8-5/8	11-49/64	15-49/64	CV50	W3805H-CV50
	8xD	1.4961 - 1.7322	38.00 - 43.99	13-7/8	16-31/32	20-31/32	CV50	W3808H-CV50
	10xD	1.4961 - 1.7322	38.00 - 43.99	17-1/4	20-7/16	24-7/16	CV50	W3810H-CV50

Connection Accessories

		Admissible Tightening Torque*
75020-IP20-1	8IP-20	60 in-lb (678 N-cm)

*Tightening torques are calculated with a friction coefficient of $\mu = 0.14$ and develop 90% of ultimate yield strength

WARNING Refer to Speed and Feed charts for recommended adjustments to speeds and feeds. Refer to page A50: 30 for deep hole drilling guidelines in this section of the catalog. Visit www.alliedmachine.com/DeepHoleGuidelines for the most up-to-date information and procedures. Factory technical assistance is available for your specific applications through our Application Engineering Team.

i = Imperial (in)
m = Metric (mm)

Mounting screws sold in multiples of 4

A DRILLING
B BORING
C REAMING
D BURNISHING
E THREADING
X SPECIALS

APX Drill Heads

44 Series | Diameter Range: 1.7323" - 2.0075" (44.00mm - 50.99mm)

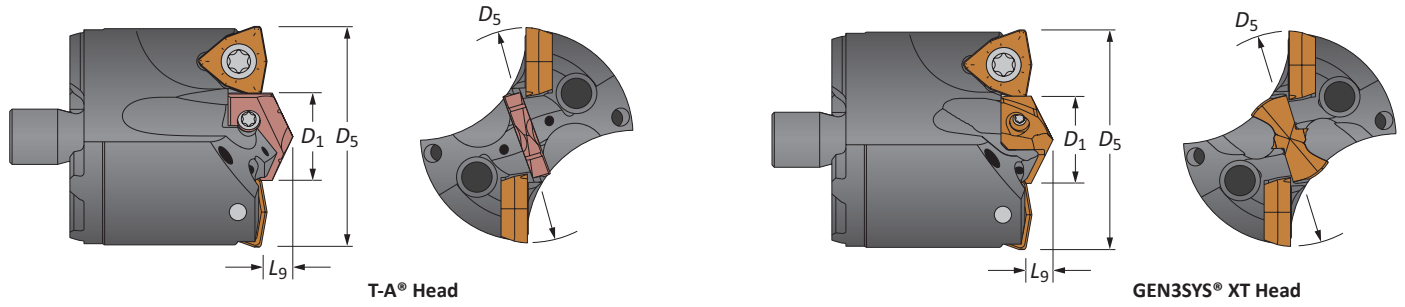

Heads

Head					T-A Head			GEN3SYS XT Head			IC Insert Size
D ₅ fractional	D ₅ inch	D ₅ mm	D ₁	L ₉	Part No.	Pilot Series	Pilot Insert	Part No.	Pilot Series	Pilot Insert	
-	1.7323	44.00	7/8	21/64	V4401D-44	1	4C*1H-0028	V4422D-44	22	7C*22P-0028	3/8
1-3/4	1.7500	44.45	7/8	21/64	V4401D-0124	1	4C*1H-0028	V4422D-0124	22	7C*22P-0028	3/8
-	1.7717	45.00	7/8	21/64	V4401D-45	1	4C*1H-0028	V4422D-45	22	7C*22P-0028	3/8
1-25/32	1.7813	45.25	7/8	21/64	V4401D-0125	1	4C*1H-0028	V4422D-0125	22	7C*22P-0028	3/8
-	1.8110	46.00	15/16	21/64	V4401D-46	1	4C*1H-0030	V4422D-46	22	7C*22P-0030	3/8
1-13/16	1.8125	46.04	15/16	21/64	V4401D-0126	1	4C*1H-0030	V4422D-0126	22	7C*22P-0030	3/8
1-27/32	1.8438	46.83	15/16	21/64	V4401D-0127	1	4C*1H-0030	V4422D-0127	22	7C*22P-0030	3/8
-	1.8504	47.00	15/16	21/64	V4401D-47	1	4C*1H-0030	V4422D-47	22	7C*22P-0030	3/8
1-7/8	1.8750	47.63	15/16	21/64	V4401D-0128	1	4C*1H-0030	V4422D-0128	22	7C*22P-0030	3/8
-	1.8898	48.00	45/64	21/64	V4401D-48	1	4C*1H-.703	V4417D-48	17	7C*17P-.703	1/2
1-29/32	1.9063	48.42	45/64	21/64	V4401D-0129	1	4C*1H-.703	V4417D-0129	17	7C*17P-.703	1/2
-	1.9291	49.00	45/64	21/64	V4401D-49	1	4C*1H-.703	V4417D-49	17	7C*17P-.703	1/2
1-15/16	1.9375	49.21	45/64	21/64	V4401D-0130	1	4C*1H-.703	V4417D-0130	17	7C*17P-.703	1/2
-	1.9685	50.00	47/64	21/64	V4401D-50	1	4C*1H-.734	V4418D-50	18	7C*18P-.734	1/2
1-31/32	1.9688	50.01	47/64	21/64	V4401D-0131	1	4C*1H-.734	V4418D-0131	18	7C*18P-.734	1/2
2	2.0000	50.80	47/64	21/64	V4401D-0200	1	4C*1H-.734	V4418D-0200	18	7C*18P-.734	1/2

*Denotes carbide grade (1 = C1, 2 = C2)

IC Inserts

Coating	Size	Grade	Geometry	Part No.	Insert Screw	Insert Driver	Admissible Tightening Torque*
AM300®	3/8	C5	Standard	OP-060408-PW	73595-IP15-1	8IP-15	41.0 in-lbs (465 N-cm)
AM300®	3/8	C1	Standard	OP-060408-1PW	73595-IP15-1	8IP-15	41.0 in-lbs (465 N-cm)
AM300®	3/8	C5	High Rake	OP-060408-PWHR	73595-IP15-1	8IP-15	41.0 in-lbs (465 N-cm)
AM300®	3/8	C5	High Impact	OP-060408-PWHI	73595-IP15-1	8IP-15	41.0 in-lbs (465 N-cm)
AM300®	1/2	C5	Standard	OP-080508-PW	74012-IP15-1	8IP-15	61.0 in-lbs (690 N-cm)
AM300®	1/2	C1	Standard	OP-080508-1PW	74012-IP15-1	8IP-15	61.0 in-lbs (690 N-cm)
AM300®	1/2	C5	High Rake	OP-080508-PWHR	74012-IP15-1	8IP-15	61.0 in-lbs (690 N-cm)
AM300®	1/2	C5	High Impact	OP-080508-PWHI	74012-IP15-1	8IP-15	61.0 in-lbs (690 N-cm)

*Tightening torques are calculated with a friction coefficient of $\mu = 0.14$ and develop 90% of ultimate yield strength

Pilot Accessories

Pilot Style	Series	Insert Screws	Insert Driver	Admissible Tightening Torque*
T-A	1	7375-IP9-1	8IP-9	27.0 in-lbs (305 N-cm)
GEN3SYS	17	72567-IP8-1	8IP-8	15.5 in-lbs (175 N-cm)
GEN3SYS	18	7375-IP9-1	8IP-9	27.0 in-lbs (305 N-cm)
GEN3SYS	22	739-IP9-1	8IP-9	27.0 in-lbs (305 N-cm)

*Tightening torques are calculated with a friction coefficient of $\mu = 0.14$ and develop 90% of ultimate yield strength

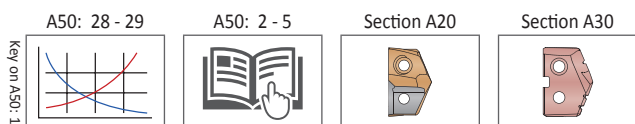

Non-stocked diameters are also available. Follow the examples shown below.

Inch	38 series, T-A (1 series), 1.6790"	Part No. = V3801D-1.6790
Metric	38 series, T-A (1 series), 42.15mm	Part No. = V3801D-42.15

IC inserts sold in multiples of 2 | Insert screws sold in multiples of 10



APX Drill Holders

44 Series | Diameter Range: 1.7323" - 2.0075" (44.00mm - 50.99mm)

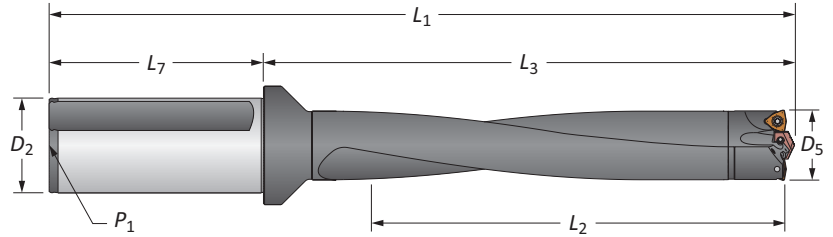

Straight Shank

	Length	D ₅	Body			Shank			Part No.
			L ₂	L ₃	L ₁	L ₇	D ₂	P ₁	
i	3xD	1.7323 - 2.0075	6	8-17/32	11-15/64	2-11/16	1-1/2	1/4	W4403H-150F
	5xD	1.7323 - 2.0075	10	12-35/64	15-1/4	2-11/16	1-1/2	1/4	W4405H-150F
	8xD	1.7323 - 2.0075	16	18-37/64	21-17/64	2-11/16	1-1/2	1/4	W4408H-150F
	10xD	1.7323 - 2.0075	20-1/8	22-19/32	25-9/32	2-11/16	1-1/2	1/4	W4410H-150F
	3xD	1.7323 - 2.0075	6	8-33/64	13-1/32	4-1/2	2	1/4	W4403H-200F
	5xD	1.7323 - 2.0075	10	12-35/64	17-3/64	4-1/2	2	1/4	W4405H-200F
	8xD	1.7323 - 2.0075	16	18-37/64	23-5/64	4-1/2	2	1/4	W4408H-200F
	10xD	1.7323 - 2.0075	20-1/8	22-19/32	27-3/32	4-1/2	2	1/4	W4410H-200F
m	3xD	44.00 - 50.99	151.5	216.8	286.9	70.0	40.0	1/4*	W4403H-40FM
	5xD	44.00 - 50.99	255.0	318.8	388.9	70.0	40.0	1/4*	W4405H-40FM
	8xD	44.00 - 50.99	407.9	471.8	541.8	70.0	40.0	1/4*	W4408H-40FM
	10xD	44.00 - 50.99	510.0	573.8	643.8	70.0	40.0	1/4*	W4410H-40FM
	3xD	44.00 - 50.99	151.5	216.8	296.9	80.0	50.0	1/4*	W4403H-50FM
	5xD	44.00 - 50.99	255.0	318.8	398.8	80.0	50.0	1/4*	W4405H-50FM
	8xD	44.00 - 50.99	407.9	471.8	551.7	80.0	50.0	1/4*	W4408H-50FM
	10xD	44.00 - 50.99	510.0	573.8	653.8	80.0	50.0	1/4*	W4410H-50FM

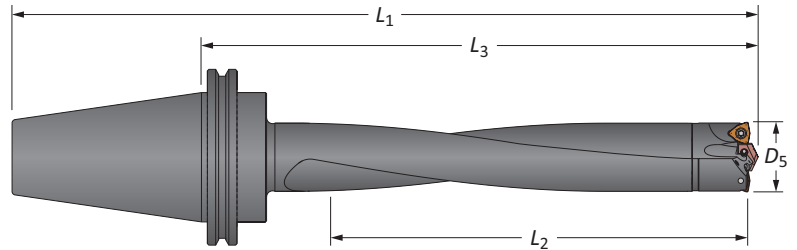

*Thread to BSP and ISO 7-1



CAT Integral Shank

	Length	D ₅		Body			Shank	Part No.
		inch	mm	L ₂	L ₃	L ₁		
i	3xD	1.7323 - 2.0075	44.00 - 50.99	6	9-1/4	11-15/16	CV40	W4403H-CV40
	5xD	1.7323 - 2.0075	44.00 - 50.99	10	13-17/64	15-61/64	CV40	W4405H-CV40
	8xD	1.7323 - 2.0075	44.00 - 50.99	16	19-19/64	21-63/64	CV40	W4408H-CV40
	10xD	1.7323 - 2.0075	44.00 - 50.99	20-1/8	23-5/16	26	CV40	W4410H-CV40
	3xD	1.7323 - 2.0075	44.00 - 50.99	6	9-1/4	13-1/4	CV50	W4403H-CV50
	5xD	1.7323 - 2.0075	44.00 - 50.99	10	13-17/64	17-17/64	CV50	W4405H-CV50
	8xD	1.7323 - 2.0075	44.00 - 50.99	16	19-19/64	23-19/64	CV50	W4408H-CV50
	10xD	1.7323 - 2.0075	44.00 - 50.99	20	23-5/16	27-5/16	CV50	W4410H-CV50

Connection Accessories

		Admissible Tightening Torque*
Mounting Screw 75020-IP20-1	Mounting Screw Driver 8IP-20	
		60 in-lb (678 N-cm)

*Tightening torques are calculated with a friction coefficient of $\mu = 0.14$ and develop 90% of ultimate yield strength

⚠ WARNING Refer to Speed and Feed charts for recommended adjustments to speeds and feeds. Refer to page A50: 30 for deep hole drilling guidelines in this section of the catalog. Visit www.alliedmachine.com/DeepHoleGuidelines for the most up-to-date information and procedures. Factory technical assistance is available for your specific applications through our Application Engineering Team.

i = Imperial (in)
m = Metric (mm)



Mounting screws sold in multiples of 4

APX Drill Heads

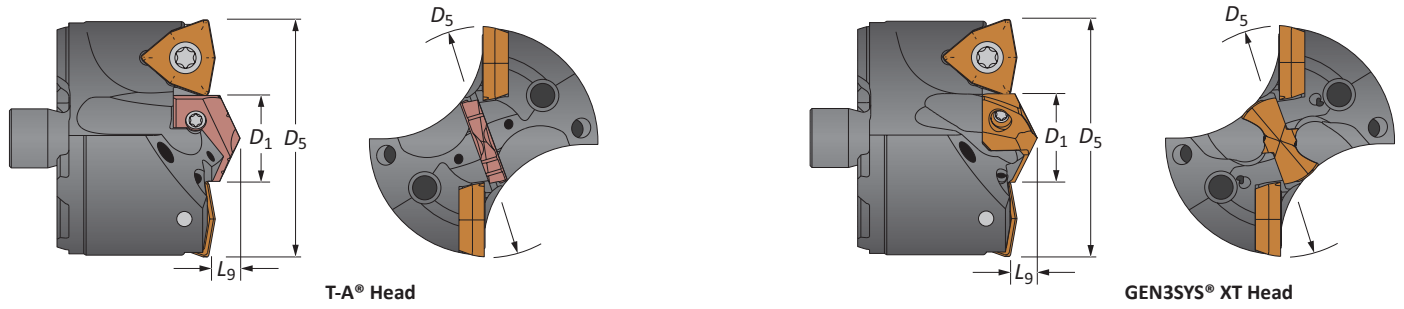
51 Series | Diameter Range: 2.0076" - 2.2438" (51.00mm - 56.99mm)





Heads

Head					T-A Head			GEN3SYS XT Head			IC Insert Size
D ₅ fractional	D ₅ inch	D ₅ mm	D ₁	L ₉	Part No.	Pilot Series		Part No.	Pilot Series		
-	2.0079	51.00	25/32	11/32	V5101D-51	1	4C*1H-0025	V5118D-51	18	7C*18P-0025	1/2
2-1/32	2.0313	51.59	25/32	11/32	V5101D-0201	1	4C*1H-0025	V5118D-0201	18	7C*18P-0025	1/2
-	2.0472	52.00	25/32	11/32	V5101D-52	1	4C*1H-0025	V5118D-52	18	7C*18P-0025	1/2
2-1/16	2.0625	52.39	25/32	11/32	V5101D-0202	1	4C*1H-0025	V5118D-0202	18	7C*18P-0025	1/2
-	2.0866	53.00	27/32	11/32	V5101D-53	1	4C*1H-0027	V5120D-53	20	7C*20P-0027	1/2
2-3/32	2.0938	53.18	27/32	11/32	V5101D-0203	1	4C*1H-0027	V5120D-0203	20	7C*20P-0027	1/2
2-1/8	2.1250	53.98	27/32	11/32	V5101D-0204	1	4C*1H-0027	V5120D-0204	20	7C*20P-0027	1/2
-	2.1260	54.00	15/16	11/32	V5101D-54	1	4C*1H-0030	V5122D-54	22	7C*22P-0030	1/2
2-5/32	2.1563	54.77	15/16	11/32	V5101D-0205	1	4C*1H-0030	V5122D-0205	22	7C*22P-0030	1/2
-	2.1654	55.00	15/16	11/32	V5101D-55	1	4C*1H-0030	V5122D-55	22	7C*22P-0030	1/2
2-3/16	2.1875	55.56	15/16	11/32	V5101D-0206	1	4C*1H-0030	V5122D-0206	22	7C*22P-0030	1/2
-	2.2047	56.00	15/16	11/32	V5101D-56	1	4C*1H-0030	V5122D-56	22	7C*22P-0030	1/2
2-7/32	2.2188	56.36	13/16	11/32	V5101D-0207	1	4C*1H-0026	V5120D-0207	20	7C*20P-0026	9/16

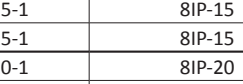

*Denotes carbide grade (1 = C1, 2 = C2)

IC Inserts

Coating	Size	Grade	Geometry	 Part No.	 Insert Screw	 Insert Driver	Admissible Tightening Torque*
AM300®	1/2	C5	Standard	OP-080508-PW	74012-IP15-1	8IP-15	61.0 in-lbs (690 N-cm)
AM300®	1/2	C1	Standard	OP-080508-1PW	74012-IP15-1	8IP-15	61.0 in-lbs (690 N-cm)
AM300®	1/2	C5	High Rake	OP-080508-PWHR	74012-IP15-1	8IP-15	61.0 in-lbs (690 N-cm)
AM300®	1/2	C5	High Impact	OP-080508-PWHI	74012-IP15-1	8IP-15	61.0 in-lbs (690 N-cm)
AM300®	9/16	C5	Standard	OP-090608-PW	75014-IP20-1	8IP-20	121.0 in-lbs (1370 N-cm)
AM300®	9/16	C1	Standard	OP-090608-1PW	75014-IP20-1	8IP-20	121.0 in-lbs (1370 N-cm)
AM300®	9/16	C5	High Rake	OP-090608-PWHR	75014-IP20-1	8IP-20	121.0 in-lbs (1370 N-cm)
AM300®	9/16	C5	High Impact	OP-090608-PWHI	75014-IP20-1	8IP-20	121.0 in-lbs (1370 N-cm)

*Tightening torques are calculated with a friction coefficient of $\mu = 0.14$ and develop 90% of ultimate yield strength

Pilot Accessories

Pilot Style	Series	 Insert Screws	 Insert Driver	Admissible Tightening Torque*
T-A	1	7375-IP9-1	8IP-9	27.0 in-lbs (305 N-cm)
GEN3SYS	18	7375-IP9-1	8IP-9	27.0 in-lbs (305 N-cm)
GEN3SYS	20	7375-IP9-1	8IP-9	27.0 in-lbs (305 N-cm)
GEN3SYS	22	739-IP9-1	8IP-9	27.0 in-lbs (305 N-cm)

*Tightening torques are calculated with a friction coefficient of $\mu = 0.14$ and develop 90% of ultimate yield strength

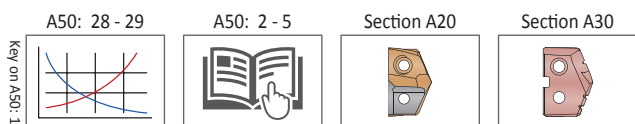

Non-stocked diameters are also available. Follow the examples shown below.

Inch	38 series, T-A (1 series), 1.6790"	Part No. = V3801D-1.6790
Metric	38 series, T-A (1 series), 42.15mm	Part No. = V3801D-42.15

IC inserts sold in multiples of 2 | Insert screws sold in multiples of 10



APX Drill Holders

51 Series | Diameter Range: 2.0076" - 2.2438" (51.00mm - 56.99mm)

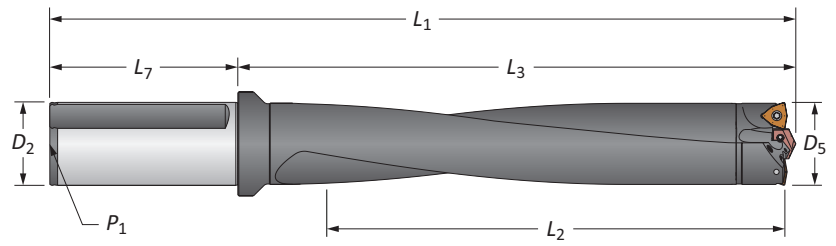

Straight Shank

	Length	D ₅	Body			Shank			Part No.
			L ₂	L ₃	L ₁	L ₇	D ₂	P ₁	
i	3xD	2.0076 - 2.2438	6-3/8	8-7/8	13-3/8	4-1/2	2	1/4	W5103H-200F
	5xD	2.0076 - 2.2438	11-1/8	13-3/8	17-7/8	4-1/2	2	1/4	W5105H-200F
	8xD	2.0076 - 2.2438	17-7/8	20-3/32	24-19/32	4-1/2	2	1/4	W5108H-200F
	10xD	2.0076 - 2.2438	22-3/8	24-19/32	29-3/32	4-1/2	2	1/4	W5110H-200F
m	3xD	51.00 - 56.99	161.8	225.5	305.5	80.0	50.0	1/4*	W5103H-50FM
	5xD	51.00 - 56.99	285.0	339.6	419.6	80.0	50.0	1/4*	W5105H-50FM
	8xD	51.00 - 56.99	455.9	510.5	590.5	80.0	50.0	1/4*	W5108H-50FM
	10xD	51.00 - 56.99	570.0	624.6	704.6	80.0	50.0	1/4*	W5110H-50FM

*Thread to BSP and ISO 7-1

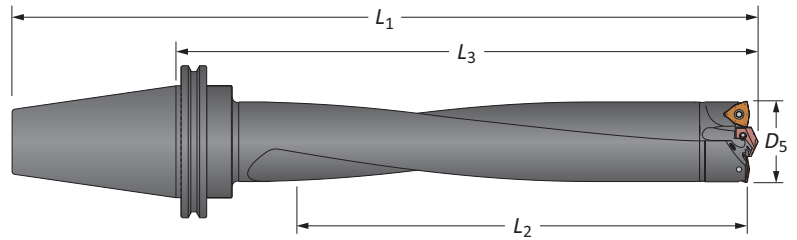

CV50 Shank

	Length	D ₅		Body			Shank	Part No.
		inch	mm	L ₂	L ₃	L ₁		
i	3xD	2.0076 - 2.2438	51.00 - 56.99	6-3/8	9-47/64	13-47/64	CV50	W5103H-CV50
	5xD	2.0076 - 2.2438	51.00 - 56.99	11-1/4	14-7/32	18-7/32	CV50	W5105H-CV50
	8xD	2.0076 - 2.2438	51.00 - 56.99	17-7/8	20-61/64	24-61/64	CV50	W5108H-CV50
	10xD	2.0076 - 2.2438	51.00 - 56.99	22-3/8	25-7/16	29-7/16	CV50	W5110H-CV50

Connection Accessories

Mounting Screw	Mounting Screw Driver	Admissible Tightening Torque*
75020-IP20-1	8IP-20	60 in-lb (678 N-cm)

*Tightening torques are calculated with a friction coefficient of $\mu = 0.14$ and develop 90% of ultimate yield strength

WARNING Refer to Speed and Feed charts for recommended adjustments to speeds and feeds. Refer to page A50: 30 for deep hole drilling guidelines in this section of the catalog. Visit www.alliedmachine.com/DeepHoleGuidelines for the most up-to-date information and procedures. Factory technical assistance is available for your specific applications through our Application Engineering Team.

i = Imperial (in)
m = Metric (mm)

Mounting screws sold in multiples of 4

APX Drill Heads

57 Series | Diameter Range: 2.2439" - 2.4799" (57.00mm - 62.99mm)

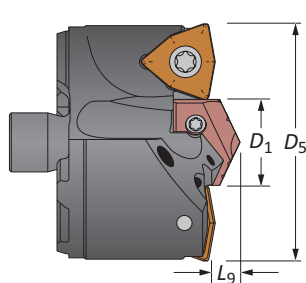

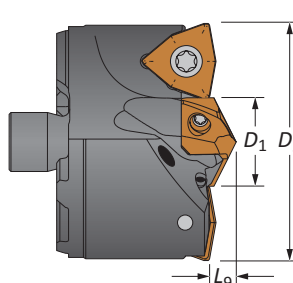
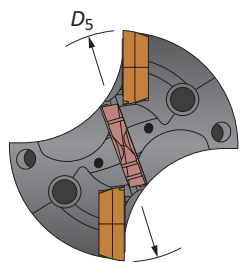

T-A® Head

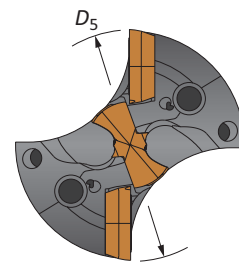

GEN3SYS® XT Head





Heads

Head					T-A Head			GEN3SYS XT Head			IC Insert Size
D ₅ fractional	D ₅ inch	D ₅ mm	D ₁	L ₉	Part No.	Pilot Series		Part No.	Pilot Series		
-	2.2441	57.00	29/32	25/64	V5701D-57	1	4C*1H-0029	V5722D-57	22	7C*22P-0029	9/16
2-1/4	2.2500	57.15	29/32	25/64	V5701D-0208	1	4C*1H-0029	V5722D-0208	22	7C*22P-0029	9/16
2-9/32	2.2813	57.94	29/32	25/64	V5701D-0209	1	4C*1H-0029	V5722D-0209	22	7C*22P-0029	9/16
-	2.2835	58.00	29/32	25/64	V5701D-58	1	4C*1H-0029	V5722D-58	22	7C*22P-0029	9/16
2-5/16	2.3125	58.74	29/32	25/64	V5701D-0210	1	4C*1H-0029	V5722D-0210	22	7C*22P-0029	9/16
-	2.3228	59.00	15/16	25/64	V5701D-59	1	4C*1H-0030	V5722D-59	22	7C*22P-0030	9/16
2-11/32	2.3438	59.53	15/16	25/64	V5701D-0211	1	4C*1H-0030	V5722D-0211	22	7C*22P-0030	9/16
-	2.3622	60.00	15/16	25/64	V5701D-60	1	4C*1H-0030	V5722D-60	22	7C*22P-0030	9/16
2-3/8	2.3750	60.33	15/16	25/64	V5701D-0212	1	4C*1H-0030	V5722D-0212	22	7C*22P-0030	9/16
-	2.4016	61.00	1	25/64	V5702D-61	2	4C*2H-0100	V5724D-61	24	7C*24P-0100	9/16
2-13/32	2.4063	61.12	1	25/64	V5702D-0213	2	4C*2H-0100	V5724D-0213	24	7C*24P-0100	9/16
2-7/16	2.4375	61.91	1	25/64	V5702D-0214	2	4C*2H-0100	V5724D-0214	24	7C*24P-0100	9/16
-	2.4409	62.00	1-1/16	25/64	V5702D-62	2	4C*2H-0102	V5726D-62	26	7C*26P-0102	9/16
2-15/32	2.4688	62.71	1-1/16	25/64	V5702D-0215	2	4C*2H-0102	V5726D-0215	26	7C*26P-0102	9/16

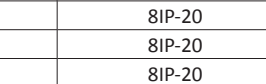

*Denotes carbide grade (1 = C1, 2 = C2)

IC Inserts

Coating	Size	Grade	Geometry	 Part No.	 Insert Screw	 Insert Driver	Admissible Tightening Torque*
AM300®	9/16	C5	Standard	OP-090608-PW	75014-IP20-1	8IP-20	121.0 in-lbs (1370 N-cm)
AM300®	9/16	C1	Standard	OP-090608-1PW	75014-IP20-1	8IP-20	121.0 in-lbs (1370 N-cm)
AM300®	9/16	C5	High Rake	OP-090608-PWHR	75014-IP20-1	8IP-20	121.0 in-lbs (1370 N-cm)
AM300®	9/16	C5	High Impact	OP-090608-PWHI	75014-IP20-1	8IP-20	121.0 in-lbs (1370 N-cm)

*Tightening torques are calculated with a friction coefficient of $\mu = 0.14$ and develop 90% of ultimate yield strength

Pilot Accessories

Pilot Style	Series	 Insert Screws	 Insert Driver	Admissible Tightening Torque*
T-A	1	7375-IP9-1	8IP-9	27.0 in-lbs (305 N-cm)
T-A	2	7495-IP15-1	8IP-15	61.0 in-lbs (690 N-cm)
GEN3SYS	22	739-IP9-1	8IP-9	27.0 in-lbs (305 N-cm)
GEN3SYS	24	739-IP9-1	8IP-9	27.0 in-lbs (305 N-cm)
GEN3SYS	26	7495-IP15-1	8IP-15	61.0 in-lbs (690 N-cm)

*Tightening torques are calculated with a friction coefficient of $\mu = 0.14$ and develop 90% of ultimate yield strength

A50: 28 - 29



A50: 2 - 5



Section A20

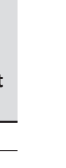

Section A30

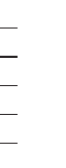

Non-stocked diameters are also available. Follow the examples shown below.

Inch	38 series, T-A (1 series), 1.6790"	Part No. = V3801D-1.6790
Metric	38 series, T-A (1 series), 42.15mm	Part No. = V3801D-42.15

IC inserts sold in multiples of 2 | Insert screws sold in multiples of 10

APX Drill Holders

57 Series | Diameter Range: 2.2439" - 2.4799" (57.00mm - 62.99mm)

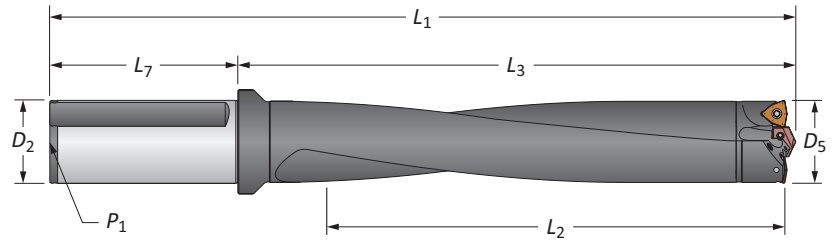

Straight Shank

	Length	D ₅	Body			Shank			Part No.
			L ₂	L ₃	L ₁	L ₇	D ₂	P ₁	
i	3xD	2.2439 - 2.4799	7-1/8	9-35/64	14-1/16	4-1/2	2	1/4	W5703H-200F
	5xD	2.2439 - 2.4799	12-3/8	14-33/64	19-1/64	4-1/2	2	1/4	W5705H-200F
	8xD	2.2439 - 2.4799	19-3/4	21-31/32	26-15/32	4-1/2	2	1/4	W5708H-200F
	10xD	2.2439 - 2.4799	24-3/4	26-59/64	31-27/64	4-1/2	2	1/4	W5710H-200F
m	3xD	57.00 - 62.99	179.9	242.7	322.7	80.0	50.0	1/4*	W5703H-50FM
	5xD	57.00 - 62.99	315.0	368.6	448.6	80.0	50.0	1/4*	W5705H-50FM
	8xD	57.00 - 62.99	503.9	557.8	637.8	80.0	50.0	1/4*	W5708H-50FM
	10xD	57.00 - 62.99	626.9	683.8	763.8	80.0	50.0	1/4*	W5710H-50FM

*Thread to BSP and ISO 7-1

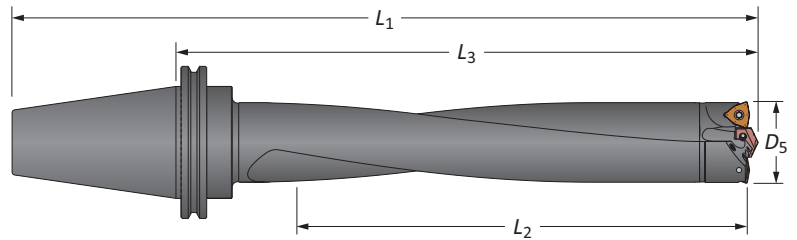

CV50 Shank

	Length	D ₅		Body			Shank	Part No.
		inch	mm	L ₂	L ₃	L ₁		
i	3xD	2.2439 - 2.4799	57.00 - 62.99	7-1/8	10-17/32	14-17/32	CV50	W5703H-CV50
	5xD	2.2439 - 2.4799	57.00 - 62.99	12-3/8	15-31/64	19-31/64	CV50	W5705H-CV50
	8xD	2.2439 - 2.4799	57.00 - 62.99	19-7/8	22-15/16	26-15/16	CV50	W5708H-CV50
	10xD	2.2439 - 2.4799	57.00 - 62.99	24-3/4	27-57/64	31-57/64	CV50	W5710H-CV50

Connection Accessories

Mounting Screw	Mounting Screw Driver	Admissible Tightening Torque*
75020-IP20-1	8IP-20	60 in-lb (678 N-cm)

*Tightening torques are calculated with a friction coefficient of $\mu = 0.14$ and develop 90% of ultimate yield strength

⚠ WARNING Refer to Speed and Feed charts for recommended adjustments to speeds and feeds. Refer to page A50: 30 for deep hole drilling guidelines in this section of the catalog. Visit www.alliedmachine.com/DeepHoleGuidelines for the most up-to-date information and procedures. Factory technical assistance is available for your specific applications through our Application Engineering Team.

i = Imperial (in)
m = Metric (mm)



Mounting screws sold in multiples of 4

APX Drill Heads

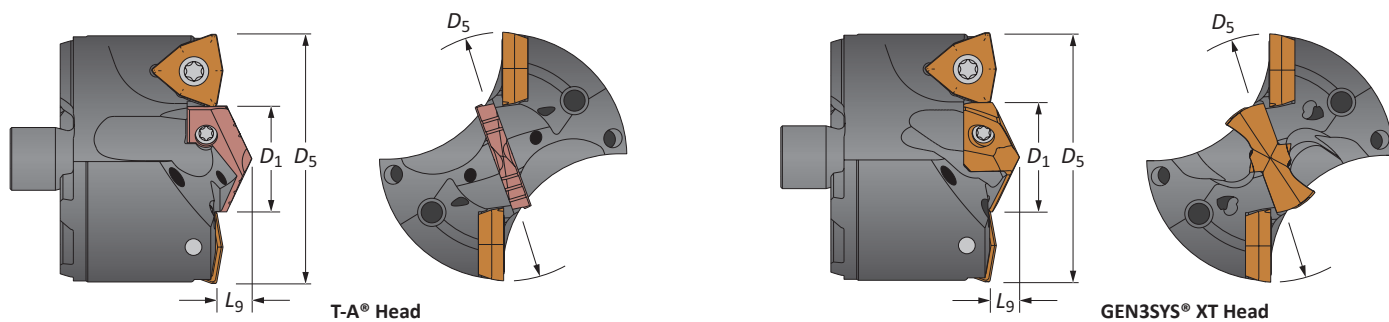
63 Series | Diameter Range: 2.4800" - 2.755" (63.00mm - 69.99mm)





Heads

Head					T-A Head			GEN3SYS XT Head			IC Insert Size
D_5 fractional	D_5 inch	D_5 mm	D_1	L_9	Part No.	Pilot Series		Part No.	Pilot Series		
-	2.4803	63.00	1-1/8	7/16	V6302D-63	2	4C*2H-0104	V6326D-63	26	7C*26P-0104	9/16
2-1/2	2.5000	63.50	1-1/8	7/16	V6302D-0216	2	4C*2H-0104	V6326D-0216	26	7C*26P-0104	9/16
-	2.5197	64.00	1-1/8	7/16	V6302D-64	2	4C*2H-0104	V6326D-64	26	7C*26P-0104	9/16
2-17/32	2.5313	64.29	1-1/8	7/16	V6302D-0217	2	4C*2H-0104	V6326D-0217	26	7C*26P-0104	9/16
-	2.5591	65.00	1-1/8	7/16	V6302D-65	2	4C*2H-0104	V6326D-65	26	7C*26P-0104	9/16
2-9/16	2.5625	65.09	1-3/16	7/16	V6302D-0218	2	4C*2H-0106	V6329D-0218	29	7C*29P-0106	9/16
2-19/32	2.5938	65.88	1-3/16	7/16	V6302D-0219	2	4C*2H-0106	V6329D-0219	29	7C*29P-0106	9/16
-	2.5984	66.00	1-3/16	7/16	V6302D-66	2	4C*2H-0106	V6329D-66	29	7C*29P-0106	9/16
2-5/8	2.6250	66.68	1-3/16	7/16	V6302D-0220	2	4C*2H-0106	V6329D-0220	29	7C*29P-0106	9/16
-	2.6378	67.00	1-1/4	7/16	V6302D-67	2	4C*2H-0108	V6329D-67	29	7C*29P-0108	9/16
2-21/32	2.6563	67.47	1-1/4	7/16	V6302D-0221	2	4C*2H-0108	V6329D-0221	29	7C*29P-0108	9/16
-	2.6772	68.00	1-1/4	7/16	V6302D-68	2	4C*2H-0108	V6329D-68	29	7C*29P-0108	9/16
2-11/16	2.6875	68.26	1-1/4	7/16	V6302D-0222	2	4C*2H-0108	V6329D-0222	29	7C*29P-0108	9/16
-	2.7165	69.00	1-5/16	7/16	V6302D-69	2	4C*2H-0110	V6332D-69	32	7C*32P-0110	9/16
2-23/32	2.7188	69.06	1-5/16	7/16	V6302D-0223	2	4C*2H-0110	V6332D-0223	32	7C*32P-0110	9/16
2-3/4	2.7500	69.85	1-5/16	7/16	V6302D-0224	2	4C*2H-0110	V6332D-0224	32	7C*32P-0110	9/16



*Denotes carbide grade (1 = C1, 2 = C2)

IC Inserts

Coating	Size	Grade	Geometry	 Part No.	 Insert Screw	 Insert Driver	Admissible Tightening Torque*
AM300®	9/16	C5	Standard	OP-090608-PW	75014-IP20-1	8IP-20	121.0 in-lbs (1370 N-cm)
AM300®	9/16	C1	Standard	OP-090608-1PW	75014-IP20-1	8IP-20	121.0 in-lbs (1370 N-cm)
AM300®	9/16	C5	High Rake	OP-090608-PWHR	75014-IP20-1	8IP-20	121.0 in-lbs (1370 N-cm)
AM300®	9/16	C5	High Impact	OP-090608-PWHI	75014-IP20-1	8IP-20	121.0 in-lbs (1370 N-cm)

*Tightening torques are calculated with a friction coefficient of $\mu = 0.14$ and develop 90% of ultimate yield strength

Pilot Accessories

Pilot Style	Series	 Insert Screws	 Insert Driver	Admissible Tightening Torque*
T-A	2	7495-IP15-1	8IP-15	61.0 in-lbs (690 N-cm)
GEN3SYS	26	7495-IP15-1	8IP-15	61.0 in-lbs (690 N-cm)
GEN3SYS	29	7495-IP15-1	8IP-15	61.0 in-lbs (690 N-cm)
GEN3SYS	32	7495-IP15-1	8IP-15	61.0 in-lbs (690 N-cm)

*Tightening torques are calculated with a friction coefficient of $\mu = 0.14$ and develop 90% of ultimate yield strength

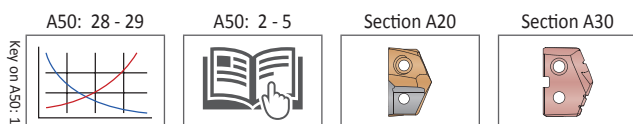

Non-stocked diameters are also available. Follow the examples shown below.

Inch	38 series, T-A (1 series), 1.6790"	Part No. = V3801D-1.6790
Metric	38 series, T-A (1 series), 42.15mm	Part No. = V3801D-42.15

IC inserts sold in multiples of 2 | Insert screws sold in multiples of 10

APX Drill Holders

63 Series | Diameter Range: 2.4800" - 2.755" (63.00mm - 69.99mm)

A

DRILLING

B

BORING

C

REAMING

D

BURNISHING

E

THREADING

X

SPECIALS

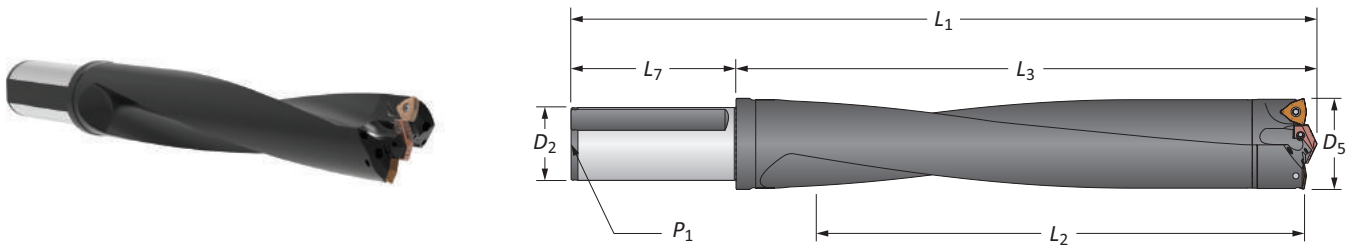

Straight Shank

	Length	Body				Shank			Part No.
		D ₅	L ₂	L ₃	L ₁	L ₇	D ₂	P ₁	
i	3xD	2.4800 - 2.7555	7-7/8	10-11/32	14-27/32	4-1/2	2	1/4	W6303H-200F
	5xD	2.4800 - 2.7555	13-3/4	15-27/32	20-11/32	4-1/2	2	1/4	W6305H-200F
	8xD	2.4800 - 2.7555	22-1/8	24-1/8	28-5/8	4-1/2	2	1/4	W6308H-200F
	10xD	2.4800 - 2.7555	27-1/8	29-11/64	33-43/64	4-1/2	2	1/4	W6310H-200F
m	3xD	63.00 - 69.99	200.8	262.6	342.6	80.0	50.0	1/4*	W6303H-50FM
	5xD	63.00 - 69.99	350.0	402.6	482.6	80.0	50.0	1/4*	W6305H-50FM
	8xD	63.00 - 69.99	560.0	612.6	692.6	80.0	50.0	1/4*	W6308H-50FM
	10xD	63.00 - 69.99	688.3	740.9	820.9	80.0	50.0	1/4*	W6310H-50FM

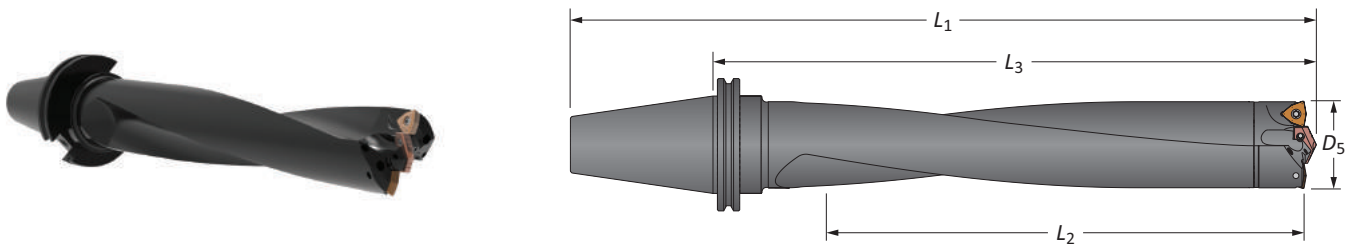

*Thread to BSP and ISO 7-1



CV50 Shank

	Length	D ₅		Body			Shank	Part No.
		inch	mm	L ₂	L ₃	L ₁		
i	3xD	2.4800 - 2.7555	63.00 - 69.99	7-7/8	11-7/16	15-7/16	CV50	W6303H-CV50
	5xD	2.4800 - 2.7555	63.00 - 69.99	13-3/4	16-15/16	20-15/16	CV50	W6305H-CV50
	8xD	2.4800 - 2.7555	63.00 - 69.99	22	25-13/64	29-13/64	CV50	W6308H-CV50
	10xD	2.4800 - 2.7555	63.00 - 69.99	26-1/2	29-43/64	33-43/64	CV50	W6310H-CV50

Connection Accessories

		Admissible Tightening Torque*
75020-IP20-1	8IP-20	60 in-lb (678 N-cm)

*Tightening torques are calculated with a friction coefficient of $\mu = 0.14$ and develop 90% of ultimate yield strength

⚠ WARNING Refer to Speed and Feed charts for recommended adjustments to speeds and feeds. Refer to page A50: 30 for deep hole drilling guidelines in this section of the catalog. Visit www.alliedmachine.com/DeepHoleGuidelines for the most up-to-date information and procedures. Factory technical assistance is available for your specific applications through our Application Engineering Team.

i = Imperial (in)
m = Metric (mm)

Mounting screws sold in multiples of 4



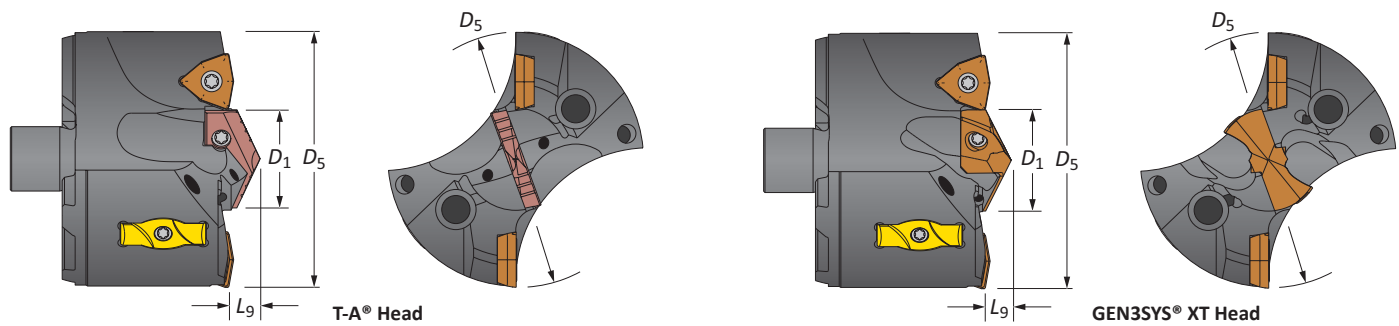

APX Drill Heads

70 Series | Diameter Range: 2.7556" - 2.9917" (70.00mm - 75.99mm)





Heads

Head					T-A Head			GEN3SYS XT Head			IC Insert Size
D_5 fractional	D_5 inch	D_5 mm	D_1	L_9	Part No.	Pilot Series		Part No.	Pilot Series		
-	2.7559	70.00	1-7/32	25/64	V7002S-70	2	4C*2H-0107	V7029S-70	29	7C*29P-0107	3/8
2-13/16	2.8125	71.44	1-7/32	25/64	V7002S-0226	2	4C*2H-0107	V7029S-0226	29	7C*29P-0107	3/8
-	2.8346	72.00	1-7/32	25/64	V7002S-72	2	4C*2H-0107	V7029S-72	29	7C*29P-0107	3/8
2-7/8	2.8750	73.03	1-7/32	25/64	V7002S-0228	2	4C*2H-0107	V7029S-0228	29	7C*29P-0107	3/8
-	2.9134	74.00	1-7/32	25/64	V7002S-74	2	4C*2H-0107	V7029S-74	29	7C*29P-0107	3/8
2-15/16	2.9375	74.61	1-7/32	25/64	V7002S-0230	2	4C*2H-0107	V7029S-0230	29	7C*29P-0107	3/8



*Denotes carbide grade (1 = C1, 2 = C2)

IC Inserts

Coating	Size	Grade	Geometry	 Part No.	 Insert Screw	 Insert Driver	Admissible Tightening Torque*
AM300®	3/8	C5	Standard	OP-060408-PW	73595-IP15-1	8IP-15	41.0 in-lbs (465 N-cm)
AM300®	3/8	C1	Standard	OP-060408-1PW	73595-IP15-1	8IP-15	41.0 in-lbs (465 N-cm)
AM300®	3/8	C5	High Rake	OP-060408-PWHR	73595-IP15-1	8IP-15	41.0 in-lbs (465 N-cm)
AM300®	3/8	C5	High Impact	OP-060408-PWHI	73595-IP15-1	8IP-15	41.0 in-lbs (465 N-cm)



*Tightening torques are calculated with a friction coefficient of $\mu = 0.14$ and develop 90% of ultimate yield strength

Wear Pads

 Part No.	 Insert Screw	 Insert Driver	Admissible Tightening Torque*
WP7095	7358-IP10-1	8IP-10	27.0 in-lbs (300 N-cm)

*Tightening torques are calculated with a friction coefficient of $\mu = 0.14$ and develop 90% of ultimate yield strength

Pilot Accessories

Pilot Style	Series	 Insert Screws	 Insert Driver	Admissible Tightening Torque*
T-A	2	7495-IP15-1	8IP-15	61.0 in-lbs (690 N-cm)
GEN3SYS	29	7495-IP15-1	8IP-15	61.0 in-lbs (690 N-cm)

*Tightening torques are calculated with a friction coefficient of $\mu = 0.14$ and develop 90% of ultimate yield strength

Non-stocked diameters are also available. Follow the examples shown below.

Inch	38 series, T-A (1 series), 1.6790"	Part No. = V3801D-1.6790
Metric	38 series, T-A (1 series), 42.15mm	Part No. = V3801D-42.15

Wear pads sold in multiples of 2 | Wear pad screws sold in multiples of 4
IC inserts sold in multiples of 2 | Insert screws sold in multiples of 10





APX Drill Holders

70 Series | Diameter Range: 2.7556" - 2.9917" (70.00mm - 75.99mm)

A

DRILLING

B

BORING

C

REAMING

D

BURNISHING

E

THREADING

X

SPECIALS

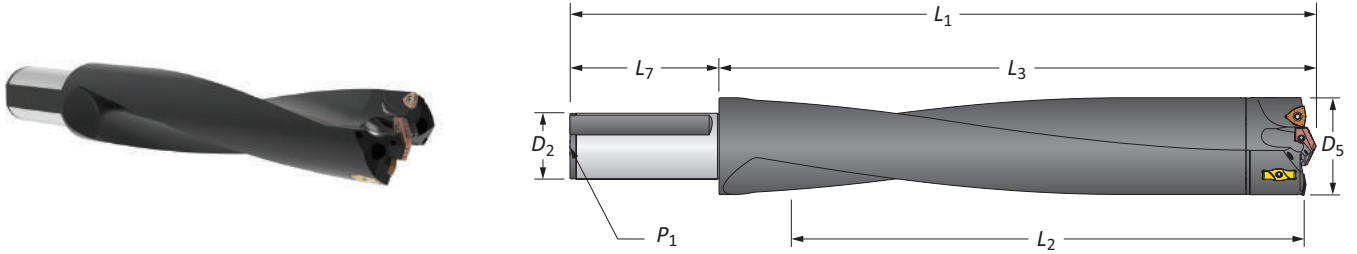

Straight Shank

	Length	D ₅	Body			Shank			Part No.
			L ₂	L ₃	L ₁	L ₇	D ₂	P ₁	
i	3xD	2.7556 - 2.9917	8-3/4	10-19/32	15-3/32	4-1/2	2	1/4	W7003H-200F
	5xD	2.7556 - 2.9917	14-7/8	16-37/64	21-5/64	4-1/2	2	1/4	W7005H-200F
	8xD	2.7556 - 2.9917	23-7/8	25-35/64	30-3/64	4-1/2	2	1/4	W7008H-200F
	10xD	2.7556 - 2.9917	27-7/8	29-35/64	34-3/64	4-1/2	2	1/4	W7010H-200F
m	3xD	70.00 - 75.99	218.8	269.0	349.0	80.0	50.0	1/4*	W7003H-50FM
	5xD	70.00 - 75.99	380.0	421.1	501.1	80.0	50.0	1/4*	W7005H-50FM
	8xD	70.00 - 75.99	608.0	649.0	729.0	80.0	50.0	1/4*	W7008H-50FM
	10xD	70.00 - 75.99	709.4	750.3	830.3	80.0	50.0	1/4*	W7010H-50FM

*Thread to BSP and ISO 7-1

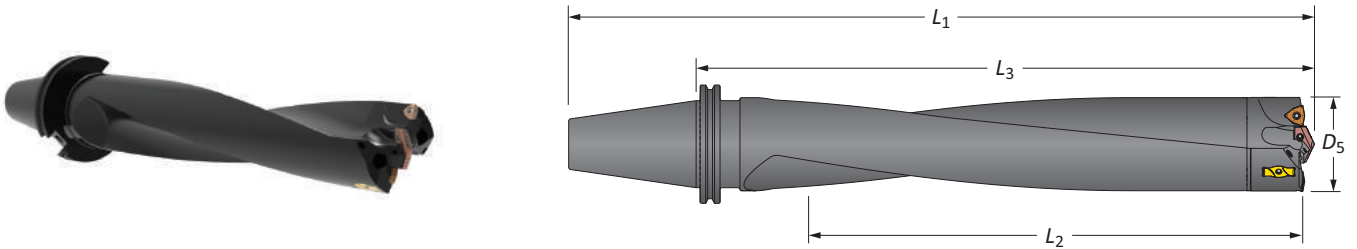

CV50 Shank

	Length	D ₅		Body			Shank	Part No.
		inch	mm	L ₂	L ₃	L ₁		
i	3xD	2.7556 - 2.9917	70.00 - 75.99	8-3/4	12-7/32	16-7/32	CV50	W7003H-CV50
	5xD	2.7556 - 2.9917	70.00 - 75.99	14-7/8	18-13/64	22-13/64	CV50	W7005H-CV50
	8xD	2.7556 - 2.9917	70.00 - 75.99	23-7/8	27-5/32	31-5/32	CV50	W7008H-CV50
	10xD	2.7556 - 2.9917	70.00 - 75.99	26-3/4	29-61/64	33-61/64	CV50	W7010H-CV50

Connection Accessories

Mounting Screw	Mounting Screw Bit	Admissible Tightening Torque*
78027-IP30-1	8IP-30B	250 in-lb (2825 N-cm)

*Tightening torques are calculated with a friction coefficient of $\mu = 0.14$ and develop 90% of ultimate yield strength

⚠ WARNING Refer to Speed and Feed charts for recommended adjustments to speeds and feeds. Refer to page A50: 30 for deep hole drilling guidelines in this section of the catalog. Visit www.alliedmachine.com/DeepHoleGuidelines for the most up-to-date information and procedures. Factory technical assistance is available for your specific applications through our Application Engineering Team.

i = Imperial (in)
m = Metric (mm)



Mounting screws sold in multiples of 4

APX Drill Heads

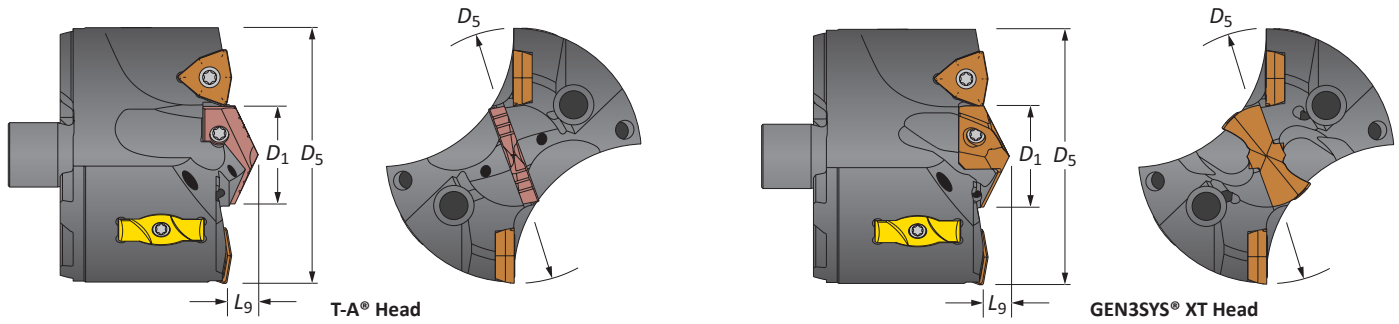
76 Series | Diameter Range: 2.9918" - 3.2673" (76.00mm - 82.99mm)





Heads

Head					T-A Head			GEN3SYS XT Head			IC Insert Size
D_5 fractional	D_5 inch	D_5 mm	D_1	L_9	Part No.	Pilot Series		Part No.	Pilot Series		
-	2.9921	76.00	1-7/32	13/32	V7602S-76	2	4C*2H-0107	V7629S-76	29	7C*29P-0107	1/2
3	3.0000	76.20	1-7/32	13/32	V7602S-0300	2	4C*2H-0107	V7629S-0300	29	7C*29P-0107	1/2
3-1/16	3.0625	77.79	1-7/32	13/32	V7602S-0302	2	4C*2H-0107	V7629S-0302	29	7C*29P-0107	1/2
-	3.0709	78.00	1-7/32	13/32	V7602S-78	2	4C*2H-0107	V7629S-78	29	7C*29P-0107	1/2
3-1/8	3.1250	79.38	1-7/32	13/32	V7602S-0304	2	4C*2H-0107	V7629S-0304	29	7C*29P-0107	1/2
-	3.1496	80.00	1-7/32	13/32	V7602S-80	2	4C*2H-0107	V7629S-80	29	7C*29P-0107	1/2
3-3/16	3.1875	80.96	1-7/32	13/32	V7602S-0306	2	4C*2H-0107	V7629S-0306	29	7C*29P-0107	1/2
-	3.2282	82.00	1-7/32	13/32	V7602S-82	2	4C*2H-0107	V7629S-82	29	7C*29P-0107	1/2
3-1/4	3.2500	82.55	1-7/32	13/32	V7602S-0308	2	4C*2H-0107	V7629S-0308	29	7C*29P-0107	1/2

*Denotes carbide grade (1 = C1, 2 = C2)

IC Inserts

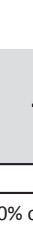
Coating	Size	Grade	Geometry	 Part No.	 Insert Screw	 Insert Driver	Admissible Tightening Torque*
AM300®	1/2	C5	Standard	OP-080508-PW	74012-IP15-1	8IP-15	61.0 in-lbs (690 N-cm)
AM300®	1/2	C1	Standard	OP-080508-1PW	74012-IP15-1	8IP-15	61.0 in-lbs (690 N-cm)
AM300®	1/2	C5	High Rake	OP-080508-PWHR	74012-IP15-1	8IP-15	61.0 in-lbs (690 N-cm)
AM300®	1/2	C5	High Impact	OP-080508-PWHI	74012-IP15-1	8IP-15	61.0 in-lbs (690 N-cm)



*Tightening torques are calculated with a friction coefficient of $\mu = 0.14$ and develop 90% of ultimate yield strength

Wear Pads

 Part No.	 Insert Screw	 Insert Driver	Admissible Tightening Torque*
WP7095	7358-IP10-1	8IP-10	27.0 in-lbs (300 N-cm)

*Tightening torques are calculated with a friction coefficient of $\mu = 0.14$ and develop 90% of ultimate yield strength

Pilot Accessories

Pilot Style	Series	 Insert Screws	 Insert Driver	Admissible Tightening Torque*
T-A	2	7495-IP15-1	8IP-15	61.0 in-lbs (690 N-cm)
GEN3SYS	29	7495-IP15-1	8IP-15	61.0 in-lbs (690 N-cm)

*Tightening torques are calculated with a friction coefficient of $\mu = 0.14$ and develop 90% of ultimate yield strength



Non-stocked diameters are also available. Follow the examples shown below.

Inch	38 series, T-A (1 series), 1.6790"	Part No. = V3801D-1.6790
Metric	38 series, T-A (1 series), 42.15mm	Part No. = V3801D-42.15

Wear pads sold in multiples of 2 | Wear pad screws sold in multiples of 4
IC inserts sold in multiples of 2 | Insert screws sold in multiples of 10

APX Drill Holders

76 Series | Diameter Range: 2.9918" - 3.2673" (76.00mm - 82.99mm)

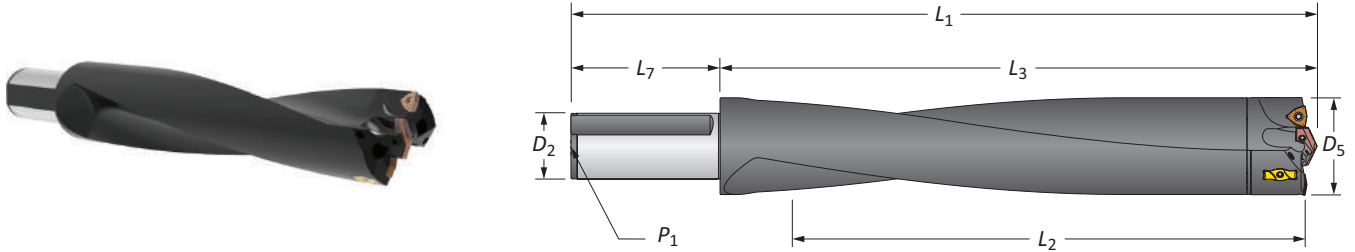

Straight Shank

Length	D ₅	Body			Shank			Part No.	
		L ₂	L ₃	L ₁	L ₇	D ₂	P ₁		
i	3xD	2.9918 - 3.2673	9-1/2	11-33/64	16-1/64	4-1/2	2	1/4	W7603H-200F
	5xD	2.9918 - 3.2673	16-3/8	18-3/64	22-35/64	4-1/2	2	1/4	W7605H-200F
	8xD	2.9918 - 3.2673	26-1/8	27-27/32	32-11/32	4-1/2	2	1/4	W7608H-200F
m	3xD	76.00 - 82.99	239.9	292.4	372.4	80.0	50.0	1/4*	W7603H-50FM
	5xD	76.00 - 82.99	415.0	458.2	538.2	80.0	50.0	1/4*	W7605H-50FM
	8xD	76.00 - 82.99	664.0	707.1	787.1	80.0	50.0	1/4*	W7608H-50FM

*Thread to BSP and ISO 7-1

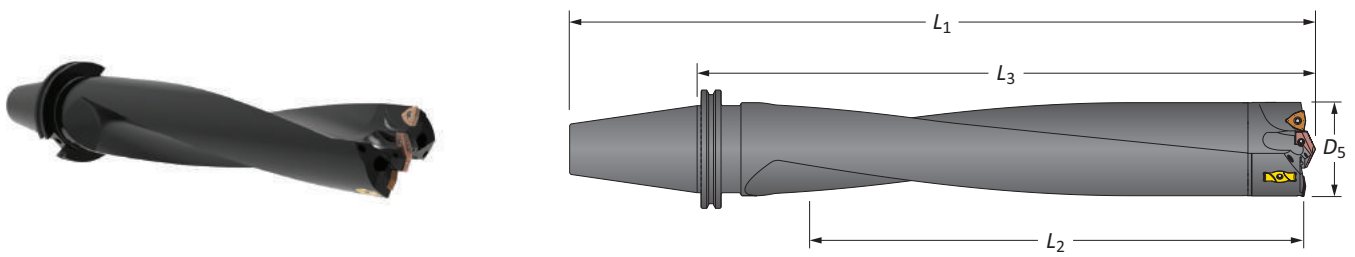

CV50 Shank

Length	D ₅		Body			Shank	Part No.	
	inch	mm	L ₂	L ₃	L ₁			
i	3xD	2.9918 - 3.2673	76.00 - 82.99	9-1/2	12-57/64	16-57/64	CV50	W7603H-CV50
	5xD	2.9918 - 3.2673	76.00 - 82.99	16-3/8	19-27/64	23-27/64	CV50	W7605H-CV50
	8xD	2.9918 - 3.2673	76.00 - 82.99	26-1/8	29-7/32	33-7/32	CV50	W7608H-CV50

Connection Accessories

Mounting Screw	Mounting Screw Bit	Admissible Tightening Torque*
78027-IP30-1	8IP-30B	250 in-lb (2825 N-cm)

*Tightening torques are calculated with a friction coefficient of $\mu = 0.14$ and develop 90% of ultimate yield strength

WARNING Refer to Speed and Feed charts for recommended adjustments to speeds and feeds. Refer to page A50: 30 for deep hole drilling guidelines in this section of the catalog. Visit www.alliedmachine.com/DeepHoleGuidelines for the most up-to-date information and procedures. Factory technical assistance is available for your specific applications through our Application Engineering Team.

i = Imperial (in)
m = Metric (mm)



Mounting screws sold in multiples of 4

APX Drill Heads

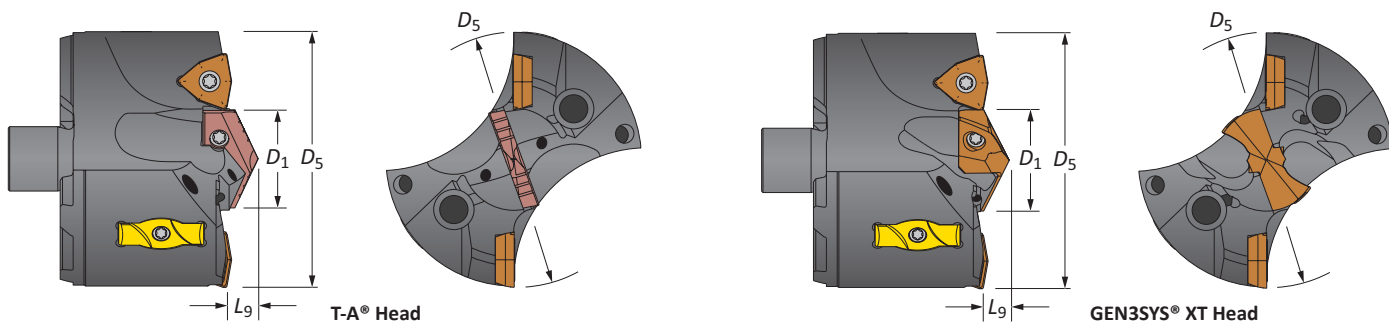
83 Series | Diameter Range: 3.2674" - 3.5035" (83.00mm - 88.99mm)





Heads

Head					T-A Head			GEN3SYS XT Head			IC Insert Size
D ₅ fractional	D ₅ inch	D ₅ mm	D ₁	L ₉	Part No.	Pilot Series		Part No.	Pilot Series		
-	3.3071	84.00	1-3/8	7/16	V8302S-84	2	4C*2H-0112	V8332S-84	32	7C*32P-0112	1/2
3-5/16	3.3125	84.14	1-3/8	7/16	V8302S-0310	2	4C*2H-0112	V8332S-0310	32	7C*32P-0112	1/2
3-3/8	3.3750	85.73	1-3/8	7/16	V8302S-0312	2	4C*2H-0112	V8332S-0312	32	7C*32P-0112	1/2
-	3.3859	86.00	1-3/8	7/16	V8302S-86	2	4C*2H-0112	V8332S-86	32	7C*32P-0112	1/2
3-7/16	3.4375	87.31	1-3/8	7/16	V8302S-0314	2	4C*2H-0112	V8332S-0314	32	7C*32P-0112	1/2
-	3.4646	88.00	1-3/8	7/16	V8302S-88	2	4C*2H-0112	V8332S-88	32	7C*32P-0112	1/2
3-1/2	3.5000	88.90	1-3/8	7/16	V8302S-0316	2	4C*2H-0112	V8332S-0316	32	7C*32P-0112	1/2



*Denotes carbide grade (1 = C1, 2 = C2)

IC Inserts

Coating	Size	Grade	Geometry	 Part No.	 Insert Screw	 Insert Driver	Admissible Tightening Torque*
AM300®	1/2	C5	Standard	OP-080508-PW	74012-IP15-1	8IP-15	61.0 in-lbs (690 N-cm)
AM300®	1/2	C1	Standard	OP-080508-1PW	74012-IP15-1	8IP-15	61.0 in-lbs (690 N-cm)
AM300®	1/2	C5	High Rake	OP-080508-PWHR	74012-IP15-1	8IP-15	61.0 in-lbs (690 N-cm)
AM300®	1/2	C5	High Impact	OP-080508-PWHI	74012-IP15-1	8IP-15	61.0 in-lbs (690 N-cm)



*Tightening torques are calculated with a friction coefficient of $\mu = 0.14$ and develop 90% of ultimate yield strength

Wear Pads

 Part No.	 Insert Screw	 Insert Driver	Admissible Tightening Torque*
WP7095	7358-IP10-1	8IP-10	27.0 in-lbs (300 N-cm)

*Tightening torques are calculated with a friction coefficient of $\mu = 0.14$ and develop 90% of ultimate yield strength

Pilot Accessories

Pilot Style	Series	 Insert Screws	 Insert Driver	Admissible Tightening Torque*
T-A	2	7495-IP15-1	8IP-15	61.0 in-lbs (690 N-cm)
GEN3SYS	32	7495-IP15-1	8IP-15	61.0 in-lbs (690 N-cm)

*Tightening torques are calculated with a friction coefficient of $\mu = 0.14$ and develop 90% of ultimate yield strength

Non-stocked diameters are also available. Follow the examples shown below.

Inch	38 series, T-A (1 series), 1.6790"	Part No. = V3801D-1.6790
Metric	38 series, T-A (1 series), 42.15mm	Part No. = V3801D-42.15

Wear pads sold in multiples of 2 | Wear pad screws sold in multiples of 4
IC inserts sold in multiples of 2 | Insert screws sold in multiples of 10

A50: 28 - 29

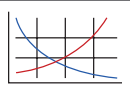

A50: 2 - 5



Section A20



Section A30



A DRILLING
B BORING
C REAMING
D BURNISHING
E THREADING
X SPECIALS



APX Drill Holders

83 Series | Diameter Range: 3.2674" - 3.5035" (83.00mm - 88.99mm)

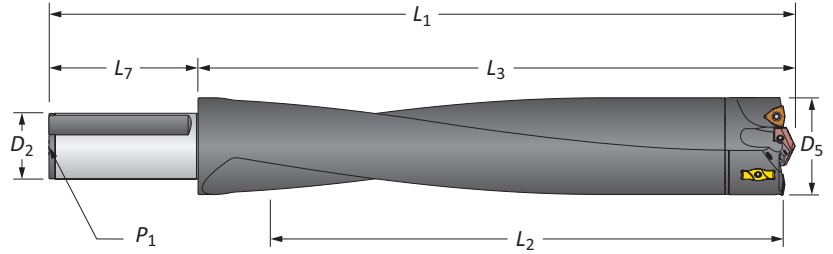

Straight Shank

	Length	D ₅		Body			Shank		Part No.	
		inch	mm	L ₂	L ₃	L ₁	L ₇	D ₂		P ₁
i	3xD	3.2674 - 3.5035	83.00 - 88.99	10-1/8	12-5/16	16-13/16	4-1/2	2	1/4	W8303H-200F
	5xD	3.2674 - 3.5035	83.00 - 88.99	17-1/2	19-5/16	23-13/16	4-1/2	2	1/4	W8305H-200F
	8xD	3.2674 - 3.5035	83.00 - 88.99	27-3/4	29-35/64	34-3/64	4-1/2	2	1/4	W8308H-200F
m	3xD	83.00 - 88.99	83.00 - 88.99	257.8	312.5	392.6	80.0	50.0	1/4*	W8303H-50FM
	5xD	83.00 - 88.99	83.00 - 88.99	445.0	490.5	570.5	80.0	50.0	1/4*	W8305H-50FM
	8xD	83.00 - 88.99	83.00 - 88.99	704.9	750.3	830.3	80.0	50.0	1/4*	W8308H-50FM

*Thread to BSP and ISO 7-1

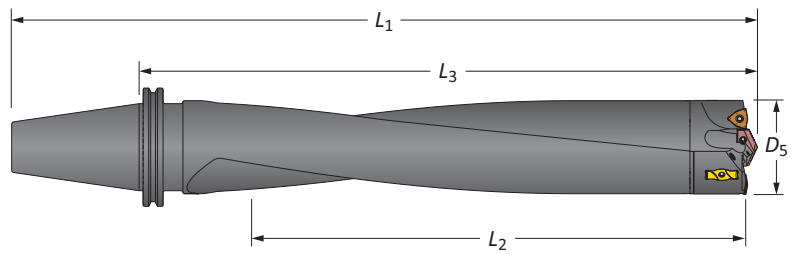

CV50 Shank

	Length	D ₅		Body			Shank	Part No.
		inch	mm	L ₂	L ₃	L ₁		
i	3xD	3.2674 - 3.5035	83.00 - 88.99	10-1/8	13-11/16	17-11/16	CV50	W8303H-CV50
	5xD	3.2674 - 3.5035	83.00 - 88.99	17-1/2	20-11/16	24-11/16	CV50	W8305H-CV50
	8xD	3.2674 - 3.5035	83.00 - 88.99	26-7/8	30-3/64	34-3/64	CV50	W8308H-CV50

Connection Accessories

Mounting Screw	Mounting Screw Bit	Admissible Tightening Torque*
78027-IP30-1	8IP-30B	250 in-lb (2825 N-cm)

*Tightening torques are calculated with a friction coefficient of $\mu = 0.14$ and develop 90% of ultimate yield strength

WARNING Refer to Speed and Feed charts for recommended adjustments to speeds and feeds. Refer to page A50: 30 for deep hole drilling guidelines in this section of the catalog. Visit www.alliedmachine.com/DeepHoleGuidelines for the most up-to-date information and procedures. Factory technical assistance is available for your specific applications through our Application Engineering Team.

i = Imperial (in)
m = Metric (mm)



Mounting screws sold in multiples of 4

APX Drill Heads

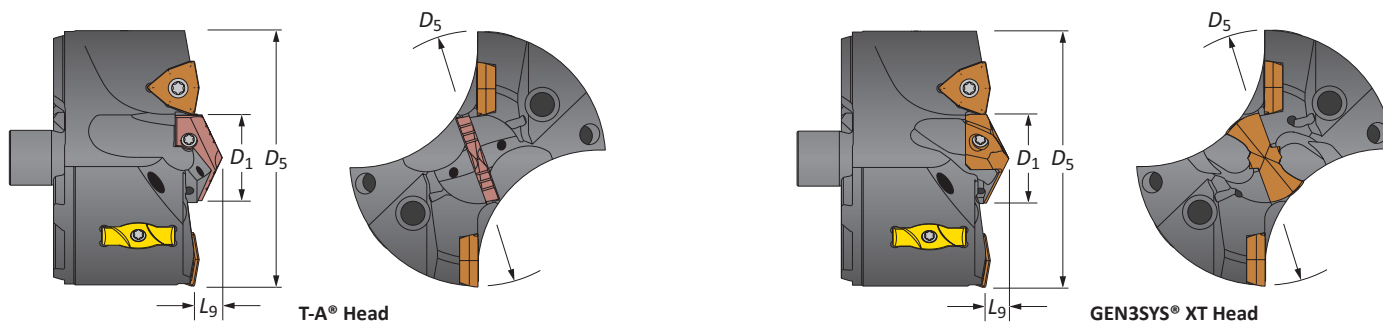
89 Series | Diameter Range: 3.5036" - 3.7400" (89.00mm - 94.99mm)





Heads

Head					T-A Head			GEN3SYS XT Head			IC Insert Size
D ₅ fractional	D ₅ inch	D ₅ mm	D ₁	L ₉	Part No.	Pilot Series		Part No.	Pilot Series		
-	3.5433	90.00	1-1/4	27/64	V8902S-90	2	4C*2H-0108	V8929S-90	29	7C*29P-0108	9/16
3-9/16	3.5625	90.49	1-1/4	27/64	V8902S-0318	2	4C*2H-0108	V8929S-0318	29	7C*29P-0108	9/16
-	3.6220	92.00	1-1/4	27/64	V8902S-92	2	4C*2H-0108	V8929S-92	29	7C*29P-0108	9/16
3-5/8	3.6250	92.08	1-1/4	27/64	V8902S-0320	2	4C*2H-0108	V8929S-0320	29	7C*29P-0108	9/16
3-11/16	3.6875	93.66	1-1/4	27/64	V8902S-0322	2	4C*2H-0108	V8929S-0322	29	7C*29P-0108	9/16
-	3.7008	94.00	1-1/4	27/64	V8902S-94	2	4C*2H-0108	V8929S-94	29	7C*29P-0108	9/16



*Denotes carbide grade (1 = C1, 2 = C2)

IC Inserts

Coating	Size	Grade	Geometry	 Part No.	 Insert Screw	 Insert Driver	Admissible Tightening Torque*
AM300®	9/16	C5	Standard	OP-090608-PW	75014-IP20-1	8IP-20	121.0 in-lbs (1370 N-cm)
AM300®	9/16	C1	Standard	OP-090608-1PW	75014-IP20-1	8IP-20	121.0 in-lbs (1370 N-cm)
AM300®	9/16	C5	High Rake	OP-090608-PWHR	75014-IP20-1	8IP-20	121.0 in-lbs (1370 N-cm)
AM300®	9/16	C5	High Impact	OP-090608-PWHI	75014-IP20-1	8IP-20	121.0 in-lbs (1370 N-cm)

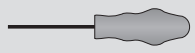

*Tightening torques are calculated with a friction coefficient of $\mu = 0.14$ and develop 90% of ultimate yield strength

Wear Pads

 Part No.	 Insert Screw	 Insert Driver	Admissible Tightening Torque*
WP7095	7358-IP10-1	8IP-10	27.0 in-lbs (300 N-cm)

*Tightening torques are calculated with a friction coefficient of $\mu = 0.14$ and develop 90% of ultimate yield strength

Pilot Accessories

Pilot Style	Series	 Insert Screws	 Insert Driver	Admissible Tightening Torque*
T-A	2	7495-IP15-1	8IP-15	61.0 in-lbs (690 N-cm)
GEN3SYS	29	7495-IP15-1	8IP-15	61.0 in-lbs (690 N-cm)

*Tightening torques are calculated with a friction coefficient of $\mu = 0.14$ and develop 90% of ultimate yield strength

Non-stocked diameters are also available. Follow the examples shown below.

Inch	38 series, T-A (1 series), 1.6790"	Part No. = V3801D-1.6790
Metric	38 series, T-A (1 series), 42.15mm	Part No. = V3801D-42.15

Wear pads sold in multiples of 2 | Wear pad screws sold in multiples of 4
IC inserts sold in multiples of 2 | Insert screws sold in multiples of 10

A50: 28 - 29

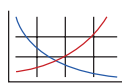

A50: 2 - 5



Section A20

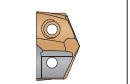

Section A30

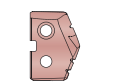

A DRILLING
B BORING
C REAMING
D BURNISHING
E THREADING
X SPECIALS



APX Drill Holders

89 Series | Diameter Range: 3.5036" - 3.7400" (89.00mm - 94.99mm)

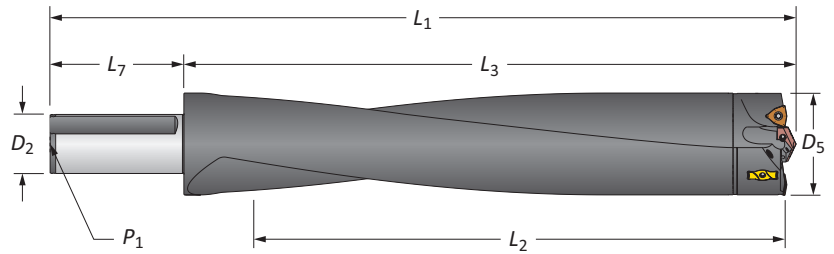

Straight Shank

	Length	D ₅	Body			Shank			Part No.
			L ₂	L ₃	L ₁	L ₇	D ₂	P ₁	
i	3xD	3.5036 - 3.7400	10-7/8	13-1/8	17-5/8	4-1/2	2	1/4	W8903H-200F
	5xD	3.5036 - 3.7400	18-5/8	20-5/8	25-1/8	4-1/2	2	1/4	W8905H-200F
	8xD	3.5036 - 3.7400	27-5/8	29-35/64	34-3/64	4-1/2	2	1/4	W8908H-200F
m	3xD	89.00 - 94.99	275.8	333.6	413.6	80.0	50.0	1/4*	W8903H-50FM
	5xD	89.00 - 94.99	475.0	523.7	603.7	80.0	50.0	1/4*	W8905H-50FM
	8xD	89.00 - 94.99	701.8	750.3	830.3	80.0	50.0	1/4*	W8908H-50FM

*Thread to BSP and ISO 7-1

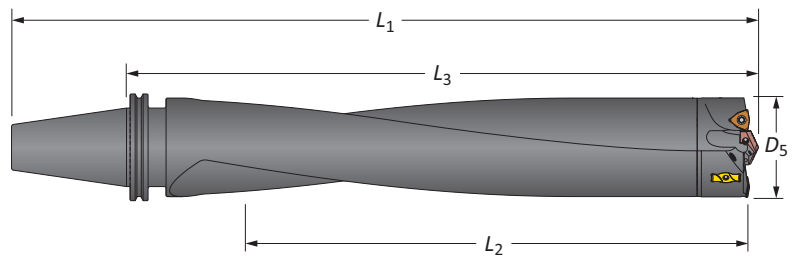

CV50 Shank

	Length	D ₅		Body			Shank	Part No.
		inch	mm	L ₂	L ₃	L ₁		
i	3xD	3.5036 - 3.7400	89.00 - 94.99	10-7/8	14-33/64	18-33/64	CV50	W8903H-CV50
	5xD	3.5036 - 3.7400	89.00 - 94.99	18-5/8	22	26	CV50	W8905H-CV50
	8xD	3.5036 - 3.7400	89.00 - 94.99	26-3/4	30-1/32	34-1/32	CV50	W8908H-CV50

Connection Accessories

Mounting Screw	Mounting Screw Bit	Admissible Tightening Torque*
78027-IP30-1	8IP-30B	250 in-lb (2825 N-cm)

*Tightening torques are calculated with a friction coefficient of $\mu = 0.14$ and develop 90% of ultimate yield strength

WARNING Refer to Speed and Feed charts for recommended adjustments to speeds and feeds. Refer to page A50: 30 for deep hole drilling guidelines in this section of the catalog. Visit www.alliedmachine.com/DeepHoleGuidelines for the most up-to-date information and procedures. Factory technical assistance is available for your specific applications through our Application Engineering Team.

i = Imperial (in)
m = Metric (mm)

Mounting screws sold in multiples of 4



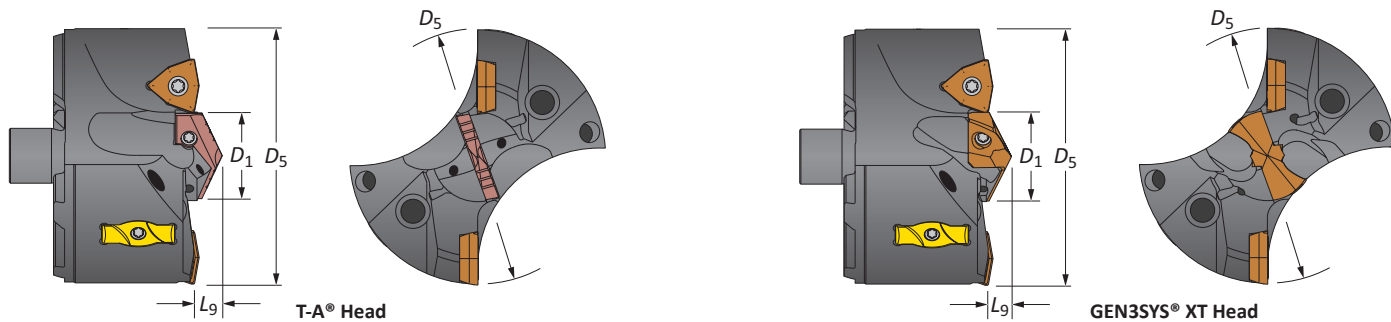

APX Drill Heads

95 Series | Diameter Range: 3.7401" - 4.0000" (95.00mm - 101.60mm)





Heads

Head					T-A Head			GEN3SYS XT Head			IC Insert Size
D_5 fractional	D_5 inch	D_5 mm	D_1	L_9	Part No.	Pilot Series		Part No.	Pilot Series		
3-3/4	3.7500	95.25	1-3/8	29/64	V9502S-0324	2	4C*2H-0112	V9532S-0324	32	7C*32P-0112	9/16
-	3.7795	96.00	1-3/8	29/64	V9502S-96	2	4C*2H-0112	V9532S-96	32	7C*32P-0112	9/16
3-13/16	3.8125	96.84	1-3/8	29/64	V9502S-0326	2	4C*2H-0112	V9532S-0326	32	7C*32P-0112	9/16
-	3.8583	98.00	1-3/8	29/64	V9502S-98	2	4C*2H-0112	V9532S-98	32	7C*32P-0112	9/16
3-7/8	3.8750	98.43	1-3/8	29/64	V9502S-0328	2	4C*2H-0112	V9532S-0328	32	7C*32P-0112	9/16
-	3.9370	100.00	1-3/8	29/64	V9502S-100	2	4C*2H-0112	V9532S-100	32	7C*32P-0112	9/16
3-15/16	3.9375	100.01	1-3/8	29/64	V9502S-0330	2	4C*2H-0112	V9532S-0330	32	7C*32P-0112	9/16
4	4.0000	101.60	1-3/8	29/64	V9502S-0400	2	4C*2H-0112	V9532S-0400	32	7C*32P-0112	9/16

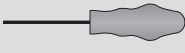

*Denotes carbide grade (1 = C1, 2 = C2)

IC Inserts

Coating	Size	Grade	Geometry	 Part No.	 Insert Screw	 Insert Driver	Admissible Tightening Torque*
AM300®	9/16	C5	Standard	OP-090608-PW	75014-IP20-1	8IP-20	121.0 in-lbs (1370 N-cm)
AM300®	9/16	C1	Standard	OP-090608-1PW	75014-IP20-1	8IP-20	121.0 in-lbs (1370 N-cm)
AM300®	9/16	C5	High Rake	OP-090608-PWHR	75014-IP20-1	8IP-20	121.0 in-lbs (1370 N-cm)
AM300®	9/16	C5	High Impact	OP-090608-PWHI	75014-IP20-1	8IP-20	121.0 in-lbs (1370 N-cm)

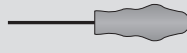

*Tightening torques are calculated with a friction coefficient of $\mu = 0.14$ and develop 90% of ultimate yield strength

Wear Pads

 Part No.	 Insert Screw	 Insert Driver	Admissible Tightening Torque*
WP7095	7358-IP10-1	8IP-10	27.0 in-lbs (300 N-cm)

*Tightening torques are calculated with a friction coefficient of $\mu = 0.14$ and develop 90% of ultimate yield strength

Pilot Accessories

Pilot Style	Series	 Insert Screws	 Insert Driver	Admissible Tightening Torque*
T-A	2	7495-IP15-1	8IP-15	61.0 in-lbs (690 N-cm)
GEN3SYS	32	7495-IP15-1	8IP-15	61.0 in-lbs (690 N-cm)

*Tightening torques are calculated with a friction coefficient of $\mu = 0.14$ and develop 90% of ultimate yield strength

Non-stocked diameters are also available. Follow the examples shown below.

Inch	38 series, T-A (1 series), 1.6790"	Part No. = V3801D-1.6790
Metric	38 series, T-A (1 series), 42.15mm	Part No. = V3801D-42.15

Wear pads sold in multiples of 2 | Wear pad screws sold in multiples of 4
IC inserts sold in multiples of 2 | Insert screws sold in multiples of 10

A50: 28 - 29

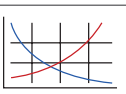

A50: 2 - 5



Section A200

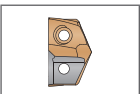

Section A300

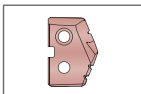

APX Drill Holders

95 Series | Diameter Range: 3.7401" - 4.0000" (95.00mm - 101.60mm)

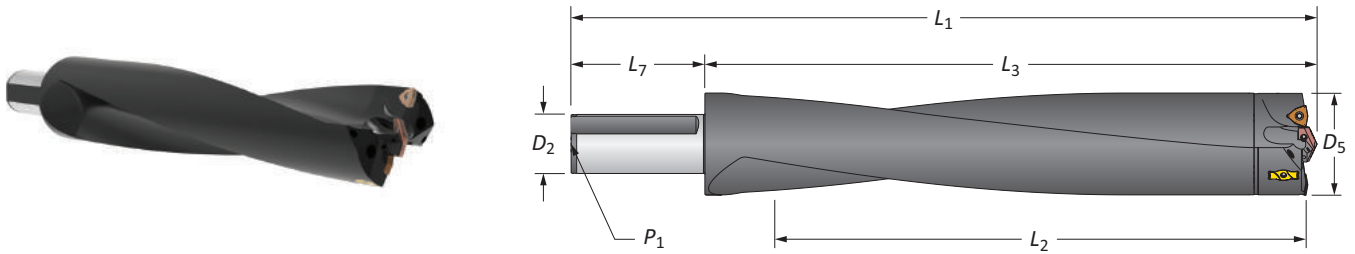

Straight Shank

	Length	D ₅	Body			Shank			Part No.
			L ₂	L ₃	L ₁	L ₇	D ₂	P ₁	
i	3xD	3.7401 - 4.0000	11-7/8	14-9/32	18-25/32	4-1/2	2	1/4	W9503H-200F
	5xD	3.7401 - 4.0000	20	22-19/64	26-51/64	4-1/2	2	1/4	W9505H-200F
	8xD	3.7401 - 4.0000	27-1/2	29-51/64	34-19/64	4-1/2	2	1/4	W9508H-200F
m	3xD	95.00 - 101.60	302.0	362.8	442.8	80.0	50.0	1/4*	W9503H-50FM
	5xD	95.00 - 101.60	508.0	566.2	646.2	80.0	50.0	1/4*	W9505H-50FM
	8xD	95.00 - 101.60	698.5	756.7	836.7	80.0	50.0	1/4*	W9508H-50FM

*Thread to BSP and ISO 7-1

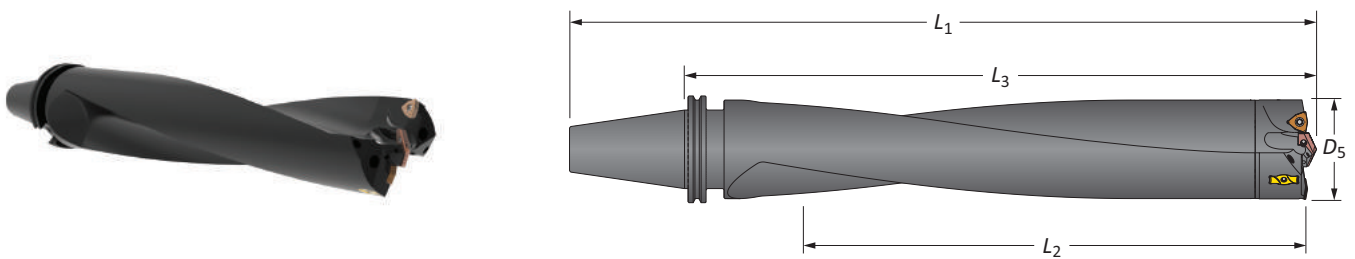

CV50 Shank

	Length	D ₅		Body			Shank	Part No.
		inch	mm	L ₂	L ₃	L ₁		
i	3xD	3.7401 - 4.0000	95.00 - 101.60	11-7/8	15-43/64	19-43/64	CV50	W9503H-CV50
	5xD	3.7401 - 4.0000	95.00 - 101.60	20	23-43/64	27-43/64	CV50	W9505H-CV50
	8xD	3.7401 - 4.0000	95.00 - 101.60	26-5/8	30-9/32	34-9/32	CV50	W9508H-CV50

Connection Accessories

Mounting Screw	Mounting Screw Bit	Admissible Tightening Torque*
78027-IP30-1	8IP-30B	250 in-lb (2825 N-cm)

*Tightening torques are calculated with a friction coefficient of $\mu = 0.14$ and develop 90% of ultimate yield strength

WARNING Refer to Speed and Feed charts for recommended adjustments to speeds and feeds. Refer to page A50: 30 for deep hole drilling guidelines in this section of the catalog. Visit www.alliedmachine.com/DeepHoleGuidelines for the most up-to-date information and procedures. Factory technical assistance is available for your specific applications through our Application Engineering Team.

i = Imperial (in)
m = Metric (mm)

Mounting screws sold in multiples of 4

Recommended Drilling Data | Imperial (inch)

ISO	Material	Hardness (BHN)	Feed Rate (IPR) by Diameter								
			Outboard Insert		5/16" IC	3/8" IC	1/2" IC	9/16" IC	3/8" IC	1/2" IC	9/16" IC
			Series	Pilot Style	33	38 - 44	44 - 51	51 - 57 - 63	70	76 - 83	89 - 95
			Speed (SFM)		1.299 - 1.495	1.496 - 1.885	1.886 - 2.210	2.211 - 2.775	2.756 - 2.991	2.992 - 3.502	3.503 - 4.000
P	Free Machining Steel 1118, 1215, 12L14, etc.	100 - 250	450 - 750	T-A/GEN3SYS	.006 - .011	.007 - .012	.009 - .012	.009 - .012	.006 - .010	.007 - .011	.007 - .012
	Low Carbon Steel 1010, 1020, 1025, 1522, 1144, etc.	85 - 275	450 - 750	T-A/GEN3SYS	.006 - .011	.007 - .012	.009 - .012	.009 - .012	.006 - .010	.007 - .011	.007 - .012
	Medium Carbon Steel 1030, 1040, 1050, 1527, 1140, 1151, etc.	125 - 325	450 - 750	T-A/GEN3SYS	.006 - .011	.007 - .012	.009 - .012	.009 - .012	.006 - .010	.007 - .011	.007 - .012
	Alloy Steel 4140, 5140, 8640, etc.	125 - 375	400 - 700	T-A/GEN3SYS	.005 - .007	.005 - .009	.007 - .010	.007 - .011	.005 - .009	.006 - .010	.006 - .010
	High Strength Alloy 4340, 4330V, 300M, etc.	225 - 400	300 - 500	T-A/GEN3SYS	.005 - .006	.005 - .007	.005 - .008	.006 - .009	.005 - .007	.005 - .008	.006 - .008
	Structural Steel A36, A285, A516, etc.	100 - 350	450 - 750	T-A/GEN3SYS	.006 - .008	.007 - .009	.008 - .010	.009 - .011	.005 - .009	.006 - .010	.007 - .010
	Tool Steel H-13, H-21, A-4, O-2, S-3, etc.	150 - 250	300 - 500	T-A/GEN3SYS	.005 - .006	.005 - .007	.007 - .009	.008 - .010	.005 - .007	.006 - .009	.007 - .010
S	High Temp Alloy Hastelloy B, Inconel 600, etc.	140 - 310	200 - 400	T-A	.004 - .005	.004 - .007	.006 - .009	.007 - .009	.004 - .006	.005 - .007	.005 - .007
	Titanium Alloy	140 - 310	300 - 500	T-A	.005 - .007	.006 - .008	.007 - .009	.008 - .010	.004 - .006	.005 - .007	.005 - .007
	Aerospace Alloy S82	185 - 350	400 - 600	T-A/GEN3SYS	.004 - .006	.005 - .007	.006 - .008	.006 - .008	.004 - .006	.005 - .007	.005 - .007
M	Stainless Steel 400 Series 416, 420, etc.	185 - 350	300 - 500	T-A/GEN3SYS	.006 - .008	.007 - .009	.008 - .010	.009 - .011	.005 - .007	.007 - .009	.007 - .010
	Stainless Steel 300 Series 304, 316, 17-4PH, etc.	135 - 275	300 - 500	T-A/GEN3SYS	.005 - .007	.006 - .008	.007 - .009	.008 - .010	.004 - .008	.006 - .010	.006 - .010
	Super Duplex Stainless Steel	135 - 275	250 - 450	T-A/GEN3SYS	.004 - .006	.005 - .007	.007 - .009	.007 - .009	.004 - .007	.006 - .009	.007 - .010
H	Wear Plate Hardox, AR400, T-1, etc.	400 - 600	300 - 500	T-A	.003 - .005	.004 - .006	.006 - .008	.007 - .009	.003 - .005	.004 - .006	.004 - .006
	Hardened Steel	300 - 500	300 - 500	T-A	.004 - .005	.005 - .006	.006 - .008	.006 - .008	.003 - .005	.004 - .006	.004 - .006
K	Nodular, Grey, Ductile Cast Iron	120 - 320	500 - 800	T-A/GEN3SYS	.005 - .009	.006 - .010	.008 - .012	.010 - .012	.008 - .010	.009 - .011	.010 - .012
N	Cast Aluminum	30 - 180	600 - 800	T-A/GEN3SYS	.009 - .012	.010 - .014	.012 - .016	.012 - .016	.006 - .009	.008 - .011	.008 - .012
	Wrought Aluminum	30 - 180	600 - 800	T-A/GEN3SYS	.007 - .011	.008 - .012	.010 - .014	.010 - .014	.006 - .009	.008 - .011	.008 - .012
	Aluminum Bronze	100 - 250	400 - 700	T-A/GEN3SYS	.005 - .007	.005 - .008	.007 - .010	.009 - .011	.006 - .009	.007 - .010	.008 - .012
	Brass	30 - 100	800	T-A/GEN3SYS	.006 - .008	.007 - .009	.008 - .010	.009 - .012	.006 - .008	.007 - .009	.008 - .012
	Copper	60	700	T-A/GEN3SYS	.002 - .005	.003 - .006	.006 - .008	.008 - .010	.006 - .008	.006 - .008	.006 - .008

Coolant Recommendations

Series	Pressure (PSI)	Flow Rate (GPM)
33	350	10
38	300	10
44	275	12
51	250	18
57	225	20
63	200	22
70	150	25
76	100	28
83	100	30
89	100	33
95	100	33

Calculations

Value	Formula
SFM	$RPM \cdot 0.262 \cdot \text{Diameter}$
RPM	$(SFM \cdot 3.82) / \text{Diameter}$
IPM	$RPM \cdot \text{IPR}$

IMPORTANT: The speeds and feeds listed above are a general starting point for all applications. Refer to the Coolant Recommendation charts for coolant requirements to run at the recommended speeds and feeds. Factory technical assistance is also available through our Application Engineering Team.

IMPORTANT: The coolant pressure and flow rate recommendations above represent a good approximation to obtain optimum tool life and chip evacuation at Allied Machine recommended speeds and feeds. If lower coolant capabilities exist in a drilling application, the APX Drilling System will still function at reduced penetration rates. Contact our Application Engineering department for a more specific recommendation of coolant requirements and/or speeds and feeds.

WARNING Tool failure can cause serious injury. To prevent: For APX holders 8xD or longer, do not rotate tool more than 50 RPM unless it is engaged with workpiece or fixture. Refer to page A50: 30 for Deep Hole Drilling Guidelines in this section of the catalog. Visit www.alliedmachine.com/DeepHoleGuidelines for the most up-to-date information and procedures. Factory technical assistance is also available for your specific applications.

Recommended Drilling Data | Metric (mm)

ISO	Material	Hardness (BHN)	Outboard Insert		Feed Rate (mm/rev) by Diameter						
			Series		5/16" IC	3/8" IC	1/2" IC	9/16" IC	3/8" IC	1/2" IC	9/16" IC
			Speed (M/min)	Pilot Style	33	38 - 44	44 - 51	51 - 57 - 63	70	76 - 83	89 - 95
P	Free Machining Steel 1118, 1215, 12L14, etc.	100 - 250	137 - 229	T-A/GEN3SYS	0.15 - 0.28	0.18 - 0.30	0.23 - 0.30	0.23 - 0.30	0.15 - 0.25	0.18 - 0.28	0.18 - 0.30
	Low Carbon Steel 1010, 1020, 1025, 1522, 1144, etc.	85 - 275	137 - 229	T-A/GEN3SYS	0.15 - 0.28	0.18 - 0.30	0.23 - 0.30	0.23 - 0.30	0.15 - 0.25	0.18 - 0.28	0.18 - 0.30
	Medium Carbon Steel 1030, 1040, 1050, 1527, 1140, 1151, etc.	125 - 325	137 - 229	T-A/GEN3SYS	0.15 - 0.28	0.18 - 0.30	0.23 - 0.30	0.23 - 0.30	0.15 - 0.25	0.18 - 0.28	0.18 - 0.30
	Alloy Steel 4140, 5140, 8640, etc.	125 - 375	122 - 213	T-A/GEN3SYS	0.13 - 0.18	0.13 - 0.23	0.18 - 0.25	0.18 - 0.28	0.13 - 0.23	0.15 - 0.25	0.15 - 0.25
	High Strength Alloy 4340, 4330V, 300M, etc.	225 - 400	91 - 152	T-A/GEN3SYS	0.13 - 0.15	0.13 - 0.18	0.13 - 0.20	0.15 - 0.23	0.13 - 0.18	0.13 - 0.20	0.15 - 0.20
	Structural Steel A36, A285, A516, etc.	100 - 350	137 - 229	T-A/GEN3SYS	0.15 - 0.20	0.18 - 0.23	0.20 - 0.25	0.23 - 0.28	0.13 - 0.23	0.15 - 0.25	0.15 - 0.25
	Tool Steel H-13, H-21, A-4, O-2, S-3, etc.	150 - 250	91 - 152	T-A/GEN3SYS	0.13 - 0.15	0.13 - 0.18	0.18 - 0.23	0.20 - 0.25	0.13 - 0.18	0.15 - 0.23	0.18 - 0.25
S	High Temp Alloy Hastelloy B, Inconel 600, etc.	140 - 310	61 - 122	T-A	0.10 - 0.13	0.10 - 0.18	0.15 - 0.23	0.18 - 0.23	0.10 - 0.15	0.13 - 0.18	0.13 - 0.18
	Titanium Alloy	140 - 310	91 - 152	T-A	0.13 - 0.18	0.15 - 0.20	0.18 - 0.23	0.20 - 0.25	0.10 - 0.15	0.13 - 0.18	0.13 - 0.18
	Aerospace Alloy S82	185 - 350	122 - 183	T-A/GEN3SYS	0.10 - 0.15	0.13 - 0.18	0.15 - 0.20	0.15 - 0.20	0.10 - 0.15	0.13 - 0.18	0.13 - 0.18
M	Stainless Steel 400 Series 416, 420, etc.	185 - 350	91 - 152	T-A/GEN3SYS	0.15 - 0.20	0.18 - 0.23	0.20 - 0.25	0.23 - 0.28	0.13 - 0.18	0.18 - 0.23	0.18 - 0.25
	Stainless Steel 300 Series 304, 316, 17-4PH, etc.	135 - 275	91 - 152	T-A/GEN3SYS	0.13 - 0.18	0.15 - 0.20	0.18 - 0.23	0.20 - 0.25	0.10 - 0.20	0.15 - 0.25	0.15 - 0.25
	Super Duplex Stainless Steel	135 - 275	76 - 137	T-A/GEN3SYS	0.10 - 0.15	0.13 - 0.18	0.18 - 0.23	0.18 - 0.23	0.10 - 0.18	0.15 - 0.23	0.18 - 0.25
H	Wear Plate Hardox, AR400, T-1, etc.	400 - 600	91 - 152	T-A	0.07 - 0.13	0.10 - 0.15	0.15 - 0.20	0.18 - 0.23	0.08 - 0.13	0.10 - 0.15	0.10 - 0.15
	Hardened Steel	300 - 500	91 - 152	T-A	0.10 - 0.13	0.13 - 0.15	0.15 - 0.20	0.15 - 0.20	0.08 - 0.13	0.10 - 0.20	0.10 - 0.20
K	Nodular, Grey, Ductile Cast Iron	120 - 320	152 - 244	T-A/GEN3SYS	0.13 - 0.23	0.15 - 0.25	0.20 - 0.30	0.25 - 0.30	0.20 - 0.25	0.23 - 0.28	0.25 - 0.30
N	Cast Aluminum	30 - 180	183 - 244	T-A/GEN3SYS	0.23 - 0.30	0.25 - 0.36	0.30 - 0.40	0.30 - 0.40	0.15 - 0.23	0.20 - 0.28	0.20 - 0.30
	Wrought Aluminum	30 - 180	183 - 244	T-A/GEN3SYS	0.18 - 0.28	0.20 - 0.30	0.25 - 0.36	0.25 - 0.36	0.15 - 0.23	0.20 - 0.28	0.20 - 0.30
	Aluminum Bronze	100 - 250	123 - 213	T-A/GEN3SYS	0.13 - 0.18	0.13 - 0.20	0.18 - 0.25	0.23 - 0.28	0.15 - 0.23	0.18 - 0.25	0.20 - 0.30
	Brass	30 - 100	244	T-A/GEN3SYS	0.15 - 0.20	0.18 - 0.23	0.20 - 0.25	0.23 - 0.30	0.15 - 0.20	0.18 - 0.23	0.20 - 0.25
	Copper	60	213	T-A/GEN3SYS	0.05 - 0.13	0.08 - 0.15	0.15 - 0.20	0.20 - 0.25	0.08 - 0.15	0.15 - 0.20	0.15 - 0.20

Coolant Recommendations

Series	Pressure (BAR)	Flow Rate (LPM)
33	24	38
38	21	38
44	19	45
51	17	68
57	16	76
63	14	83
70	10	95
76	7	106
83	7	114
89	7	125
95	7	125

Calculations

Value	Formula
M/min	RPM • 0.003 • Diameter
RPM	(M/min • 318.47) / Diameter
mm/min	RPM • mm/rev

IMPORTANT: The speeds and feeds listed above are a general starting point for all applications. Refer to the Coolant Recommendation charts for coolant requirements to run at the recommended speeds and feeds. Factory technical assistance is also available through our Application Engineering Team.

IMPORTANT: The coolant pressure and flow rate recommendations above represent a good approximation to obtain optimum tool life and chip evacuation at Allied Machine recommended speeds and feeds. If lower coolant capabilities exist in a drilling application, the APX Drilling System will still function at reduced penetration rates. Contact our Application Engineering department for a more specific recommendation of coolant requirements and/or speeds and feeds.

WARNING Tool failure can cause serious injury. To prevent: For APX holders 8xD or longer, do not rotate tool more than 50 RPM unless it is engaged with workpiece or fixture. Refer to page A50: 30 for Deep Hole Drilling Guidelines in this section of the catalog. Visit www.alliedmachine.com/DeepHoleGuidelines for the most up-to-date information and procedures. Factory technical assistance is also available for your specific applications.

A
DRILLING
B
BORING
C
REAMING
D
BURNISHING
E
THREADING
X
SPECIALS



Deep Hole Drilling Guidelines

A

DRILLING



1. Approach
50 RPM max
12 IPM (300 mm/min)

Feed the longer drill within 1/16" (1.5mm) short of the workpiece at a **maximum of 50 RPM** and 12 IPM (300 mm/min) feed rate.

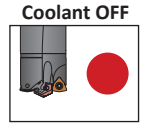
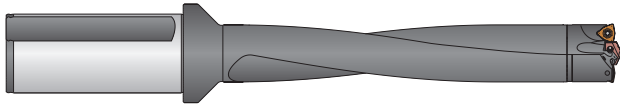

B

BORING

2. Feed-in
Speed at 75% of recommended start
Feed at 50% of recommended start

Drill 3/4" deep at 75% recommended speed and 50% recommended feed to establish the hole.

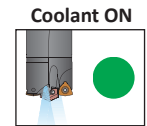
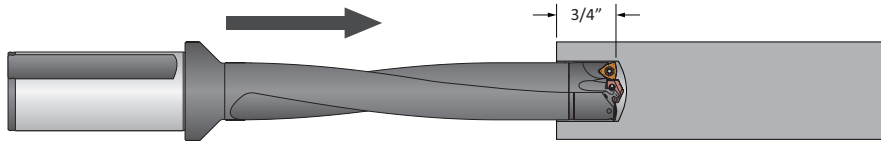

C

REAMING

3. Deep Hole Drilling - Blind
100 % RPM
100% IPR (mm/rev)

Drill to full depth at recommended speed and feed for longer drills (according to Allied Machine speed and feed charts).
***No peck cycle recommended.**

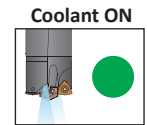
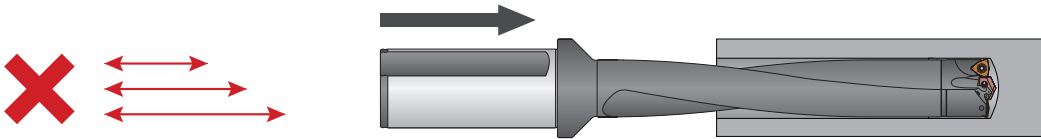

D

BURNISHING

4. Deep Hole Drilling - at Breakout
50% RPM
100% IPR (mm/rev)

***For through holes only:**
Reduce speed by 50% prior to breakout.
Do not break out more than 1/8" (3mm) past the full diameter of the drill.

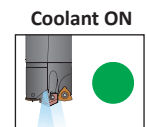
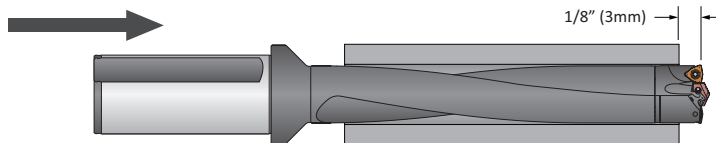

E

THREADING



5. Drill Retract
50 RPM max

Reduce speed to a **maximum of 50 RPM** before retracting from the hole.

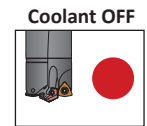
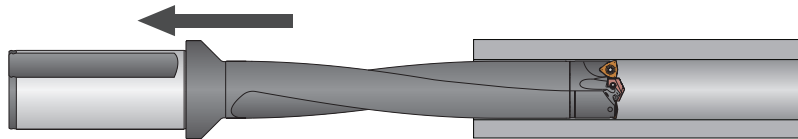

X

SPECIALS

! WARNING Tool failure can cause serious injury. To prevent: NEVER rotate these tool holders more than 50 RPM without proper engagement with a workpiece or fixture. Failure to do so could result in tool failure and/or personal injury. Visit www.alliedmachine.com/DeepHoleGuidelines for the most up-to-date information and procedures. Factory technical assistance is also available for your specific applications.

This page left intentionally blank

A

DRILLING

B

BORING

C

REAMING

D

BURNISHING

E

THREADING

X

SPECIALS

Revolution Drill®

Large Diameter Replaceable IC Insert Drilling System

► Diameter Range: 1.875" - 4.000" (47.6mm - 101.0mm)



Large Scale Innovation

The Revolution Drill has an innovative design that allows for adjustability of 0.200" (5.1mm) on diameter. This eliminates the need for special tooling and/or subsequent boring operations. With the ability to drill from solid, the Revolution Drill does not require a previously drilled pilot hole. The replaceable cartridges reduce set-up time, and the indexable inserts protect your investment. The insert design provides excellent chip control and aggressive penetration rates.

Drills from solid	Drill depths up to 4.5xD	Excellent chip control
-------------------	--------------------------	------------------------

Applicable Industries

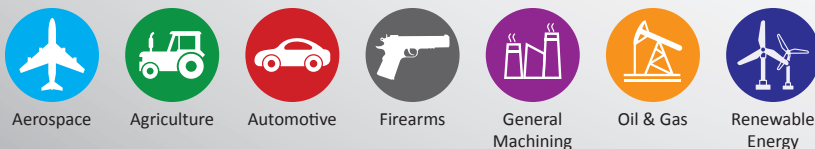

Your safety and the safety of others is very important. This catalog contains important safety messages. Always read and follow all safety precautions.



This triangle is a safety hazard symbol. It alerts you to potential safety hazards that can cause tool failure and serious injury.

When you see this symbol in the catalog, look for a related safety message that may be near this triangle or referred to in the nearby text.

There are safety signal words also used in the catalog. Safety messages follow these words.

WARNING

WARNING (shown above) means that failure to follow the precautions in this message could result in tool failure and serious injury.

NOTICE means that failure to follow the precautions in this message could result in damage to the tool or machine but not result in personal injury.

NOTE and **IMPORTANT** are also used. These are important that you read and follow but are not safety-related.

Visit www.alliedmachine.com for the most up-to-date information and procedures.

Reference Icons

The following icons will appear throughout the catalog to help you navigate between products.



Setup / Assembly Information

Detailed instructions and information regarding the corresponding part(s)

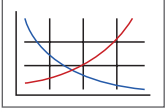

Recommended Cutting Data

Speed and feed recommendations for optimum and safe drilling

Series	Diameter Range	
	Imperial (inch)	Metric (mm)
34	1.875 - 2.000	47.6 - 50.8
36	2.000 - 2.200	50.8 - 55.9
38	2.200 - 2.400	55.9 - 61.0
42	2.400 - 2.600	61.0 - 66.0
44	2.600 - 2.800	66.0 - 71.1
46	2.800 - 3.000	71.1 - 76.2
48	3.000 - 3.200	76.2 - 81.3
52	3.200 - 3.400	81.3 - 86.4
54	3.400 - 3.600	86.4 - 91.4
56	3.600 - 3.800	91.4 - 96.5
58	3.800 - 4.000	96.5 - 101.6

Introduction Information

Product Overview 2 - 3
 Set-up Instructions 4
 Product Nomenclature 5

Drill Series

34 Series 6 - 7
 36 Series 8 - 9
 38 Series 10 - 11
 42 Series 12 - 13
 44 Series 14
 46 Series 15
 48 Series 16
 52 Series 17
 54 Series 18
 56 Series 19
 58 Series 20

Recommended Cutting Data

Imperial (inch) 22
 Metric (mm) 23

Product Overview

Series	Diameter Range		Length to Diameter Ratio	Shank Options			Inserts per Cartridge	Page
	Imperial (in)	Metric (mm)		Straight	CAT40	CAT50		
34	1.875 - 2.000	47.6 - 50.8	2.2, 3.5, 4.5	✓	✓	✓	2	6 - 7
36	2.000 - 2.200	50.8 - 55.9	2.2, 3.5, 4.5	✓	✓	✓	2	8 - 9
38	2.200 - 2.400	55.9 - 61.0	2.2, 3.5, 4.5	✓	✓	✓	2	10 - 11
42	2.400 - 2.600	61.0 - 66.0	2.2, 3.5, 4.5	✓	✓	✓	2	12 - 13
44	2.600 - 2.800	66.0 - 71.1	2.2, 3.5	✓		✓	3	14
46	2.800 - 3.000	71.1 - 76.2	2.2, 3.5	✓		✓	3	15
48	3.000 - 3.200	76.2 - 81.3	1.0, 2.5	✓		✓	3	16
52	3.200 - 3.400	81.3 - 86.4	1.0, 2.5	✓		✓	3	17
54	3.400 - 3.600	86.4 - 91.4	1.0, 2.5	✓		✓	3	18
56	3.600 - 3.800	91.4 - 96.5	1.0, 2.5	✓		✓	4	19
58	3.800 - 4.000	96.5 - 101.6	1.0, 2.5	✓		✓	4	20

NOTE: Stacked plate styles are also available

Features & Benefits

- Adjustability of 0.200" (5.1mm) on diameter
- Drill depths up to 4.5xD (standard)
- The replaceable cartridges protect your investment
- Adjustable diameter reduces inventory and cost
- The insert design allows for excellent chip control and aggressive penetration rates
- No pilot hole needed

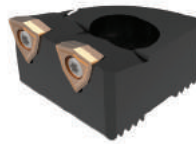

2 Inserts
(34 - 42 series)

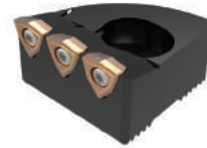

3 Inserts
(44 - 54 series)



4 Inserts
(56 - 58 series)

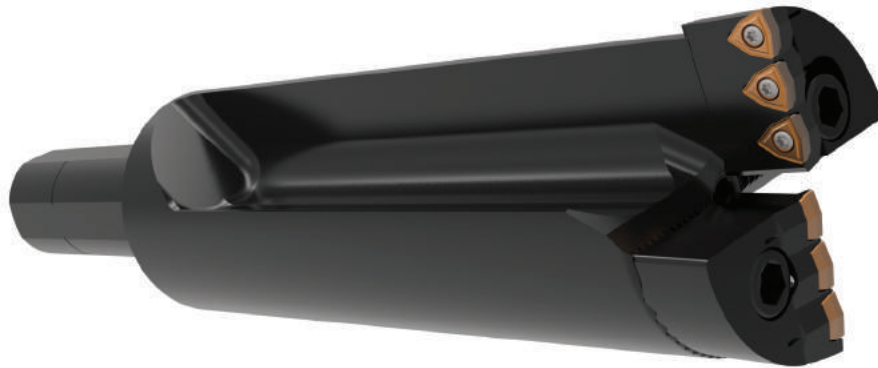

Shank Options



Straight Shank
(all series)



CAT40 Shank
(34, 36, 38, 42 series)



CAT50 Shank
(all series)

Body Lengths

- 1.0xD (48, 52, 54, 56, 58 series)
- 2.2xD (34, 36, 38, 42, 44, 46 series)
- 2.5xD (48, 52, 54, 56, 58 series)
- 3.5xD (34, 36, 38, 42, 44, 46 series)
- 4.5xD (34, 36, 38, 42, 44, 46 series)

A DRILLING
B BORING
C REAMING
D BURNISHING
E THREADING
X SPECIALS

Product Overview

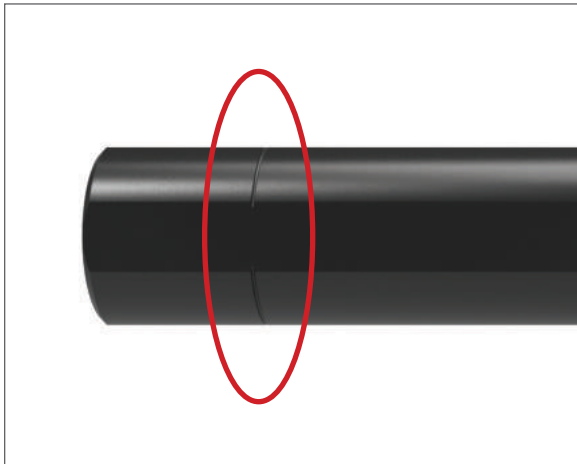
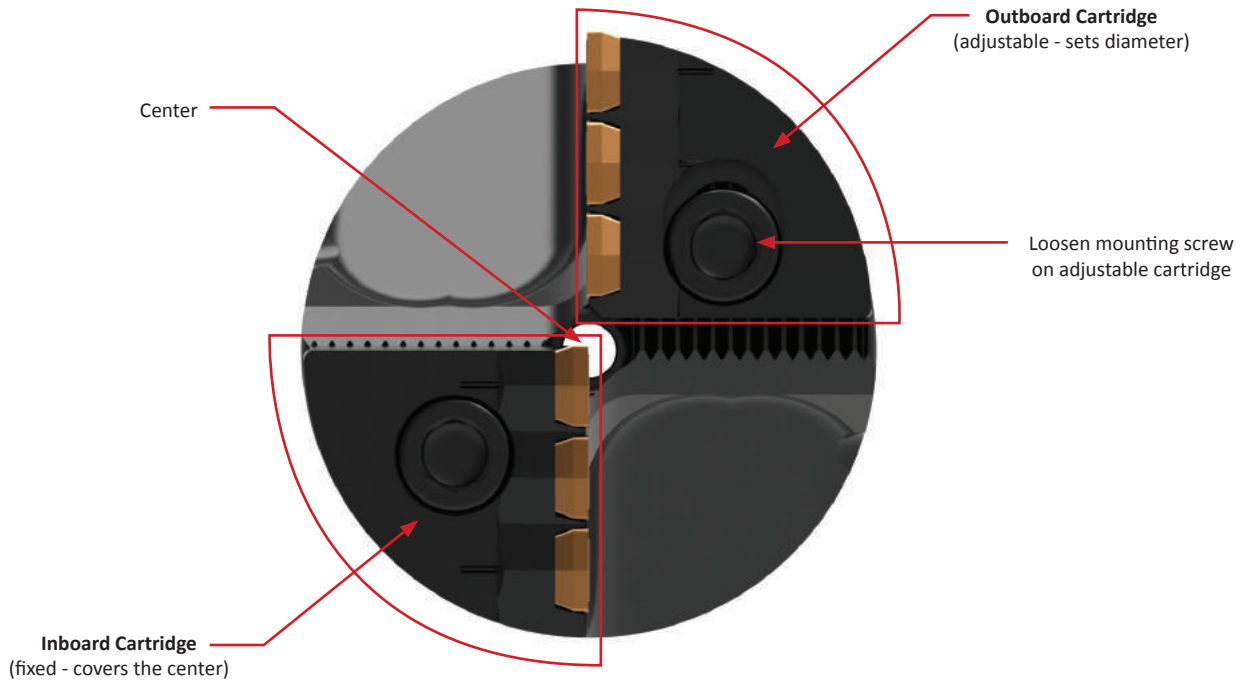

Straight Shanks

- Designed for lathe applications
- Can be cut off for use in end-mill holders
- The score mark (circled above) is provided for recommended cut length
- Cut and deburr at the score mark
- This improves rigidity when the body sits against the face of an end-mill holder



A
DRILLING
B
BORING
C
REAMING
D
BURNISHING
E
THREADING
X
SPECIALS

Set-up Instructions

A DRILLING
B BORING
C REAMING
D BURNISHING
E THREADING
X SPECIALS

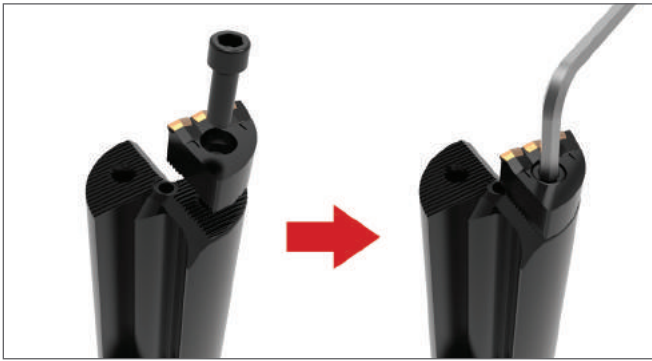

Step 1:
Mount the fixed cartridge and tighten the mounting screw to 11-14 ft-lbf (15-19 N-m).

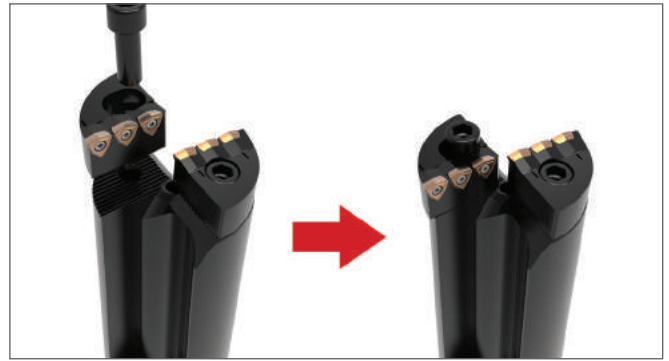

Step 2:
Finger-tighten the mounting screw on the adjustable cartridge.



Step 3:
Set the diameter using the adjustment screw against the mounting screw. Place the drill in a pre-setter to ensure the correct diameter setting.



Step 4:
Tighten the mounting screw to 11-14 ft-lbf (15-19 N-m).

IC Inserts

- The design allows for excellent chip control and aggressive penetration rates
- The proprietary AM200® and AM300® coatings increase tool life above competitors' premium coatings
- The same inserts are used for both Revolution Drill and Opening Drill products



AM300®



AM200®



TIN

Insert Application Recommendations

Carbide Grade Options

C5 (P35)	General purpose carbide grade suitable for most applications. ▶ <i>Common application in steels and stainless steels.</i>
C1 (K35)	Toughest carbide grade. Provides the best combination of edge strength and tool life. ▶ <i>Recommended for less rigid applications.</i>
C2 (K25)	Higher wear resistant carbide suitable for abrasive material applications. ▶ <i>Recommended for grey, ductile, and nodular irons.</i>

Additional Geometry Option

High Rake (HR)	Provides superior chip control and tool life in long chipping carbon and alloy steels below 200 Bhn.
----------------	--

Product Nomenclature

Revolution Drill Holders

R	34	X	22	-	150L
1	2		3		4

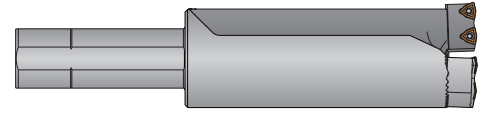

1. Drill Style	2. Series	3. Length to Diameter Ratio	4. Shank Information
R = Standard SP = Stacked Plate	34 = 34 series 44 = 44 series 54 = 54 series 36 = 36 series 46 = 46 series 56 = 56 series 38 = 38 series 48 = 48 series 58 = 58 series 42 = 42 series 52 = 52 series	10 = 1.0xD 22 = 2.2xD 25 = 2.5xD 35 = 3.5xD 45 = 4.5xD	150L = 1-1/2 Ø straight 200L = 2.0 Ø straight 40M = 40mm ISO 9766 50M = 50mm ISO 9766 CV40 = CAT40 CV50 = CAT50

Revolution Drill Inserts

OP	-	05	T3	08	-	1	H	HR
1		2	3	4		5	6	7

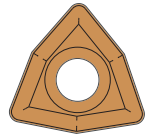

1. Compatible with:	2. IC Type	3. Thickness	4. Radius	5. Carbide Grade
Opening Drill Revolution Drill	05 = 5/16"	T3 = 5/32"	08 = 1/32"	Blank = C5 (P35) 1 = C1 (K35) 2 = C2 (K25)
6. Coating	7. Geometry			
P = AM300® H = AM200® T = TiN A = TiAlN N = TiCN U = Uncoated	Blank = General Purpose HR = High Rake			

Reference Key

Symbol	Attribute
D_1	Drill diameter range
D_2	Shank diameter
L_1	Overall length
L_2	Maximum drill depth
L_4	Holder length
L_7	Shank length
P_1	Rear pipe tap

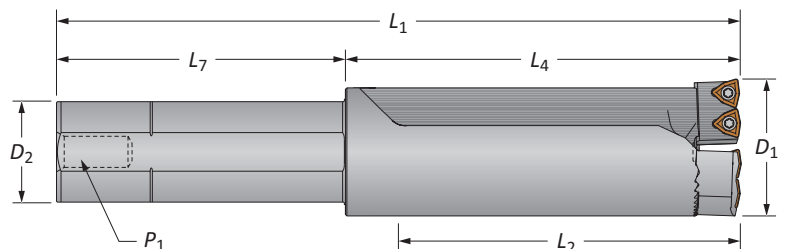



Revolution Drill Holders

34 Series | Diameter Range: 1.875" - 2.000" (47.6mm - 50.8mm)

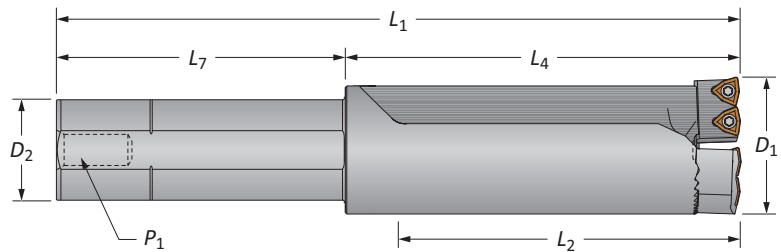

Straight Shank

Style	Length	D ₁ Range	Holder			Shank			Part No.	Cartridges
			L ₂	L ₄	L ₁	D ₂	L ₇	P ₁		
Standard	2.2xD	1.875 - 2.000	4-17/32	5-13/32	9-13/32	1-1/2	4	1/4	R34X22-150L	C34-...
Standard	3.5xD	1.875 - 2.000	7-1/32	7-29/32	11-29/32	1-1/2	4	1/4	R34X35-150L	C34-...
Standard	4.5xD	1.875 - 2.000	9-1/32	9-29/32	13-29/32	1-1/2	4	1/4	R34X45-150L	C34-...
Stacked Plate	2.2xD	1.875 - 2.000	4-27/64	5-5/16	9-5/16	1-1/2	4	1/4	SP34X22-150L	C34SP-...
Standard	2.2xD	47.6 - 50.8	114.9	137.4	207.4	40	70	-	R34X22-40M	C34-...
Standard	3.5xD	47.6 - 50.8	178.4	200.9	270.9	40	70	-	R34X35-40M	C34-...
Standard	4.5xD	47.6 - 50.8	229.2	251.7	321.7	40	70	-	R34X45-40M	C34-...
Stacked Plate	2.2xD	47.6 - 50.8	112.4	134.8	204.8	40	70	-	SP34X22-40M	C34SP-...

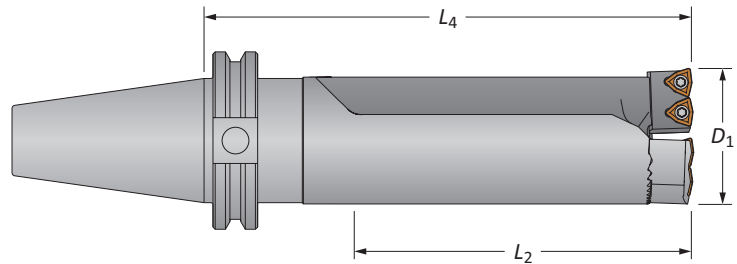

CV40 Shank

Style	Length	D ₁ Range	Holder		Shank	Part No.	Cartridges
			L ₂	L ₄			
Standard	2.2xD	1.875 - 2.000	4-17/32	6-25/32	CAT40	R34X22-CV40	C34-...
Standard	3.5xD	1.875 - 2.000	7-1/32	9-9/32	CAT40	R34X35-CV40	C34-...
Standard	4.5xD	1.875 - 2.000	9-1/32	11-9/32	CAT40	R34X45-CV40	C34-...
Stacked Plate	2.2xD	1.875 - 2.000	4-27/64	6-11/16	CAT40	SP34X22-CV40	C34SP-...

A60: 22 - 23

A60: 2 - 4

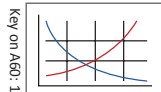

i = Imperial (in)
m = Metric (mm)



Revolution Drill Holders

34 Series | Diameter Range: 1.875" - 2.000" (47.6mm - 50.8mm)

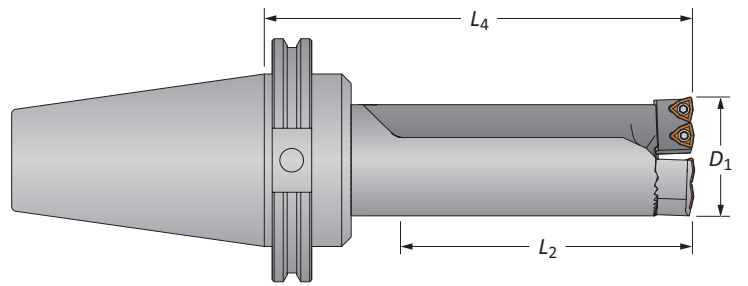

CV50 Shank

Style	Length	D ₁ Range	Holder		Shank	Part No.	Cartridges
			L ₂	L ₄			
Standard	2.2xD	1.875 - 2.000	4-17/32	6-25/32	CAT50	R34X22-CV50	C34-...
Standard	3.5xD	1.875 - 2.000	7-1/32	9-9/32	CAT50	R34X35-CV50	C34-...
Standard	4.5xD	1.875 - 2.000	9-1/32	11-9/32	CAT50	R34X45-CV50	C34-...
Stacked Plate	2.2xD	1.875 - 2.000	4-27/64	6-11/16	CAT50	SP34X22-CV50	C34SP-...

Cartridges

Holder Part No.	Replacement Cartridges	Qty. Inserts Needed	Mounting Screw	Adjusting Screw
R34...	C34-FIX	2	MS-17M-1	AS-18T9-1
	C34-ADJ	2	MS-17M-1	AS-18T9-1
SP34...	C34SP-FIX	2	MS-17M-1	AS-18T9-1
	C34SP-ADJ	2	MS-17M-1	AS-18T9-1

IC Inserts

Carbide Grade	Geometry	Part No.			Insert Screws
		AM300®	AM200®	TiN	
C5 (P35)	Standard	OP-05T308-P	OP-05T308-H	OP-05T308-T	IS-10-1
C1 (K35)	Standard	OP-05T308-1P	OP-05T308-1H	OP-05T308-1T	IS-10-1
C2 (K25)	Standard	OP-05T308-2P	OP-05T308-2H	-	IS-10-1
C5 (P35)	High Rake	OP-05T308-PHR	OP-05T308-HHR	-	IS-10-1

Key on A60: 1

A60: 22 - 23

A60: 2 - 4

Mounting screws sold in multiples of 4 | Adjusting screws sold in multiples of 4
 IC inserts sold in multiples of 10 | Insert screws sold in multiples of 10

i = Imperial (in)
m = Metric (mm)

Revolution Drill Holders

36 Series | Diameter Range: 2.000" - 2.200" (50.8mm - 55.9mm)

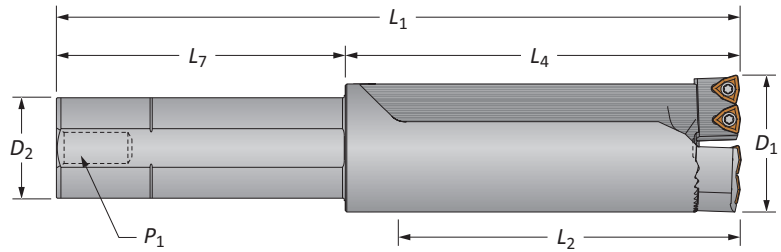

Straight Shank

Style	Length	D ₁ Range	Holder			Shank			Part No.	Cartridges
			L ₂	L ₄	L ₁	D ₂	L ₇	P ₁		
Standard	2.2xD	2.000 - 2.200	4-61/64	5-57/64	9-57/64	1-1/2	4	1/4	R36X22-150L	C36-...
Standard	3.5xD	2.000 - 2.200	7-45/64	8-41/64	12-41/64	1-1/2	4	1/4	R36X35-150L	C36-...
Standard	4.5xD	2.000 - 2.200	9-61/64	10-57/64	14-57/64	1-1/2	4	1/4	R36X45-150L	C36-...
Stacked Plate	2.2xD	2.000 - 2.200	4-57/64	5-13/16	9-13/16	1-1/2	4	1/4	SP36X22-150L	C36SP-...
Standard	2.2xD	50.8 - 55.9	126.0	149.6	219.6	40	70	-	R36X22-40M	C36-...
Standard	3.5xD	50.8 - 55.9	195.8	219.4	289.4	40	70	-	R36X35-40M	C36-...
Standard	4.5xD	50.8 - 55.9	253.0	276.6	346.6	40	70	-	R36X45-40M	C36-...
Stacked Plate	2.2xD	50.8 - 55.9	124.0	147.6	217.6	40	70	-	SP36X22-40M	C36SP-...

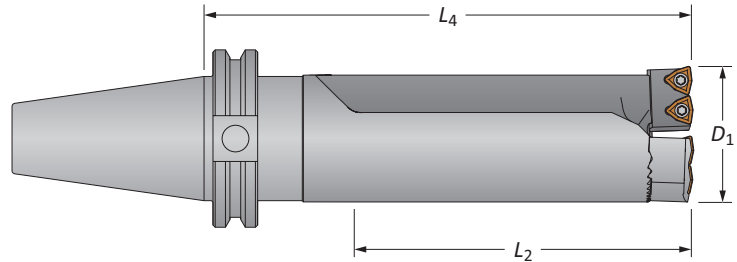

CV40 Shank

Style	Length	D ₁ Range	Holder		Shank	Part No.	Cartridges
			L ₂	L ₄			
Standard	2.2xD	2.000 - 2.200	4-61/64	7-17/64	CAT40	R36X22-CV40	C36-...
Standard	3.5xD	2.000 - 2.200	7-45/64	10-1/64	CAT40	R36X35-CV40	C36-...
Standard	4.5xD	2.000 - 2.200	9-61/64	12-17/64	CAT40	R36X45-CV40	C36-...
Stacked Plate	2.2xD	2.000 - 2.200	4-57/64	7-35/64	CAT40	SP36X22-CV40	C36SP-...

A60: 22 - 23

A60: 2 - 4

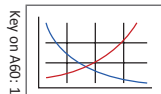

i = Imperial (in)
m = Metric (mm)



Revolution Drill Holders

36 Series | Diameter Range: 2.000" - 2.200" (50.8mm - 55.9mm)

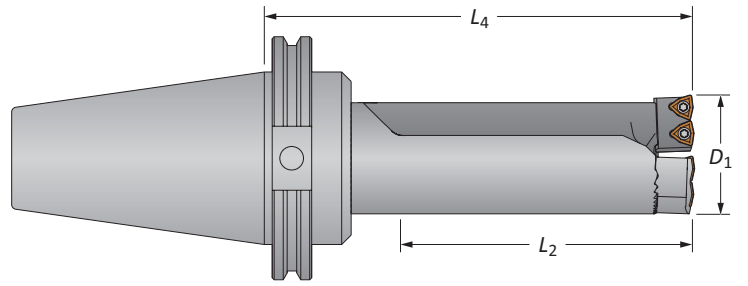

CV50 Shank

Style	Length	D ₁ Range	Holder		Shank	Part No.	Cartridges
			L ₂	L ₄			
Standard	2.2xD	2.000 - 2.200	4-61/64	7-17/64	CAT50	R36X22-CV50	C36-...
Standard	3.5xD	2.000 - 2.200	7-45/64	10-1/64	CAT50	R36X35-CV50	C36-...
Standard	4.5xD	2.000 - 2.200	9-61/64	12-17/64	CAT50	R36X45-CV50	C36-...
Stacked Plate	2.2xD	2.000 - 2.200	4-57/64	7-35/64	CAT50	SP36X22-CV50	C36SP-...

Cartridges

Holder Part No.	Replacement Cartridges	Qty. Inserts Needed	Mounting Screw	Adjusting Screw
R36...	C36-FIX	2	MS-17M-1	AS-18T9-1
	C36-ADJ	2	MS-17M-1	AS-18T9-1
SP36...	C36SP-FIX	2	MS-17M-1	AS-18T9-1
	C36SP-ADJ	2	MS-17M-1	AS-18T9-1

IC Inserts

Carbide Grade	Geometry	Part No.			Insert Screws
		AM300®	AM200®	TiN	
C5 (P35)	Standard	OP-05T308-P	OP-05T308-H	OP-05T308-T	IS-10-1
C1 (K35)	Standard	OP-05T308-1P	OP-05T308-1H	OP-05T308-1T	IS-10-1
C2 (K25)	Standard	OP-05T308-2P	OP-05T308-2H	-	IS-10-1
C5 (P35)	High Rake	OP-05T308-PHR	OP-05T308-HHR	-	IS-10-1

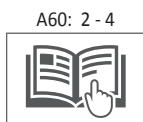
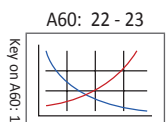

Mounting screws sold in multiples of 4 | Adjusting screws sold in multiples of 4
 IC inserts sold in multiples of 10 | Insert screws sold in multiples of 10

I = Imperial (in)
M = Metric (mm)



Revolution Drill Holders

38 Series | Diameter Range: 2.200" - 2.400" (55.9mm - 61.0mm)

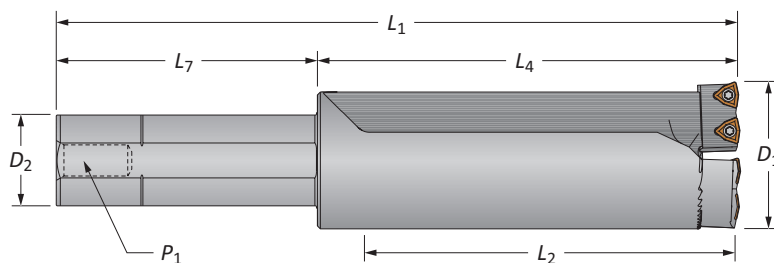

Straight Shank

Style	Length	D ₁ Range	Holder			Shank			Part No.	Cartridges
			L ₂	L ₄	L ₁	D ₂	L ₇	P ₁		
Standard	2.2xD	2.200 - 2.400	5-29/64	6-25/64	10-25/64	1-1/2	4	1/4	R38X22-150L	C38-...
Standard	3.5xD	2.200 - 2.400	8-29/64	9-25/64	13-25/64	1-1/2	4	1/4	R38X35-150L	C38-...
Standard	4.5xD	2.200 - 2.400	10-61/64	11-57/64	15-57/64	1-1/2	4	1/4	R38X45-150L	C38-...
Stacked Plate	2.2xD	2.200 - 2.400	5-3/8	6-19/64	10-19/64	1-1/2	4	1/4	SP38X22-150L	C38SP-...
Standard	2.2xD	55.9 - 61.0	138.7	162.2	232.2	40	70	-	R38X22-40M	C38-...
Standard	3.5xD	55.9 - 61.0	214.9	238.4	308.4	40	70	-	R38X35-40M	C38-...
Standard	4.5xD	55.9 - 61.0	278.4	301.9	371.9	40	70	-	R38X45-40M	C38-...
Stacked Plate	2.2xD	55.9 - 61.0	136.5	160.0	230.0	40	70	-	SP38X22-40M	C38SP-...

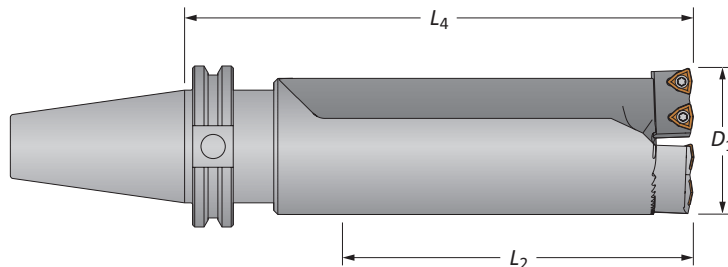

CV40 Shank

Style	Length	D ₁ Range	Holder		Shank	Part No.	Cartridges
			L ₂	L ₄			
Standard	2.2xD	2.200 - 2.400	5-29/64	7-49/64	CAT40	R38X22-CV40	C38-...
Standard	3.5xD	2.200 - 2.400	8-29/64	10-49/64	CAT40	R38X35-CV40	C38-...
Standard	4.5xD	2.200 - 2.400	10-61/64	13-17/64	CAT40	R38X45-CV40	C38-...
Stacked Plate	2.2xD	2.200 - 2.400	5-3/8	7-43/64	CAT40	SP38X22-CV40	C38SP-...

A60: 22 - 23

A60: 2 - 4

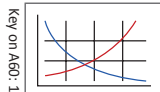

i = Imperial (in)
m = Metric (mm)



Revolution Drill Holders

38 Series | Diameter Range: 2.200" - 2.400" (55.9mm - 61.0mm)

A

DRILLING

B

BORING

C

REAMING

D

BURNISHING

E

THREADING

X

SPECIALS

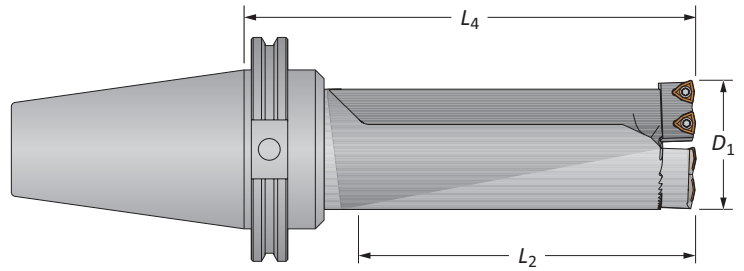

CV50 Shank

Style	Length	D_1 Range	Holder		Shank	Part No.	Cartridges
			L_2	L_4			
Standard	2.2xD	2.200 - 2.400	5-29/64	7-49/64	CAT50	R38X22-CV50	C38-...
Standard	3.5xD	2.200 - 2.400	8-29/64	10-49/64	CAT50	R38X35-CV50	C38-...
Standard	4.5xD	2.200 - 2.400	10-61/64	13-17/64	CAT50	R38X45-CV50	C38-...
Stacked Plate	2.2xD	2.200 - 2.400	5-3/8	7-43/64	CAT50	SP38X22-CV50	C38SP-...

Cartridges

Holder Part No.	Replacement Cartridges	Qty. Inserts Needed	Mounting Screw	Adjusting Screw
R38...	C38-FIX	2	MS-17M-1	AS-18T9-1
	C38-ADJ	2	MS-17M-1	AS-18T9-1
SP38...	C38SP-FIX	2	MS-17M-1	AS-18T9-1
	C38SP-ADJ	2	MS-17M-1	AS-18T9-1

IC Inserts

Carbide Grade	Geometry	Part No.			Insert Screws
		AM300®	AM200®	TiN	
C5 (P35)	Standard	OP-05T308-P	OP-05T308-H	OP-05T308-T	IS-10-1
C1 (K35)	Standard	OP-05T308-1P	OP-05T308-1H	OP-05T308-1T	IS-10-1
C2 (K25)	Standard	OP-05T308-2P	OP-05T308-2H	-	IS-10-1
C5 (P35)	High Rake	OP-05T308-PHR	OP-05T308-HHR	-	IS-10-1

A60: 22 - 23

A60: 2 - 4

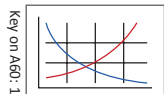

Mounting screws sold in multiples of 4 | Adjusting screws sold in multiples of 4
 IC inserts sold in multiples of 10 | Insert screws sold in multiples of 10

i = Imperial (in)
m = Metric (mm)



Revolution Drill Holders

42 Series | Diameter Range: 2.400" - 2.600" (61.0mm - 66.0mm)

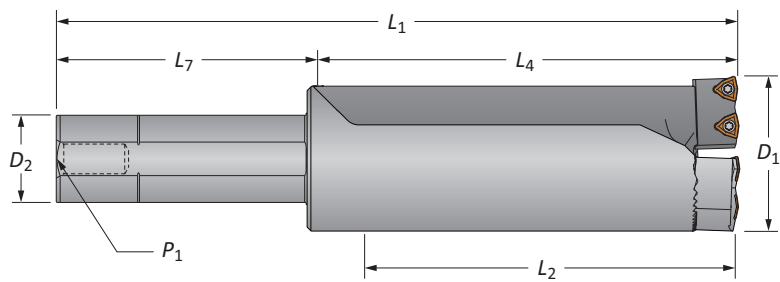

Straight Shank

Style	Length	D ₁ Range	Holder			Shank			Part No.	Cartridges
			L ₂	L ₄	L ₁	D ₂	L ₇	P ₁		
Standard	2.2xD	2.400 - 2.600	5-45/64	6-49/64	10-49/64	1-1/2	4	1/4	R42X22-150L	C42-...
Standard	3.5xD	2.400 - 2.600	9-13/64	10-17/64	14-17/64	1-1/2	4	1/4	R42X35-150L	C42-...
Standard	4.5xD	2.400 - 2.600	11-45/64	12-49/64	16-49/64	1-1/2	4	1/4	R42X45-150L	C42-...
Stacked Plate	2.2xD	2.400 - 2.600	5-3/4	6-13/16	10-13/16	1-1/2	4	1/4	SP42X22-150L	C42SP-...
Standard	2.2xD	61.0 - 66.0	144.9	171.7	241.7	40	70	-	R42X22-40M	C42-...
Standard	3.5xD	61.0 - 66.0	233.8	260.6	330.6	40	70	-	R42X35-40M	C42-...
Standard	4.5xD	61.0 - 66.0	297.3	324.1	394.1	40	70	-	R42X45-40M	C42-...
Stacked Plate	2.2xD	61.0 - 66.0	146.1	172.9	242.9	40	70	-	SP42X22-40M	C42SP-...

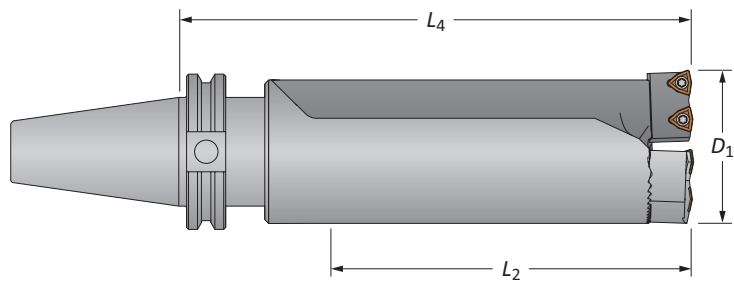

CV40 Shank

Style	Length	D ₁ Range	Holder		Shank	Part No.	Cartridges
			L ₂	L ₄			
Standard	2.2xD	2.400 - 2.600	5-45/64	8-9/64	CAT40	R42X22-CV40	C42-...
Standard	3.5xD	2.400 - 2.600	9-13/64	11-41/64	CAT40	R42X35-CV40	C42-...
Standard	4.5xD	2.400 - 2.600	11-45/64	14-9/64	CAT40	R42X45-CV40	C42-...
Stacked Plate	2.2xD	2.400 - 2.600	5-3/4	8-3/16	CAT40	SP42X22-CV40	C42SP-...

A60: 22 - 23

A60: 2 - 4

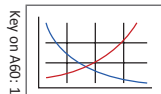

i = Imperial (in)
m = Metric (mm)



Revolution Drill Holders

42 Series | Diameter Range: 2.400" - 2.600" (61.0mm - 66.0mm)

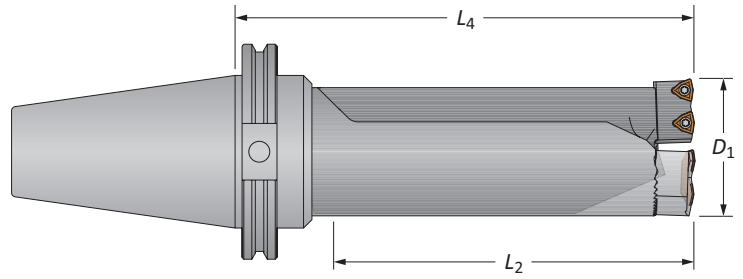

CV50 Shank

Style	Length	D ₁ Range	Holder		Shank	Part No.	Cartridges
			L ₂	L ₄			
Standard	2.2xD	2.400 - 2.600	5-45/64	8-9/64	CAT50	R42X22-CV50	C42-...
Standard	3.5xD	2.400 - 2.600	9-13/64	11-41/64	CAT50	R42X35-CV50	C42-...
Standard	4.5xD	2.400 - 2.600	11-45/64	14-9/64	CAT50	R42X45-CV50	C42-...
Stacked Plate	2.2xD	2.400 - 2.600	5-3/4	8-3/16	CAT50	SP42X22-CV50	C42SP-...

Cartridges

Holder Part No.	Replacement Cartridges	Qty. Inserts Needed	Mounting Screw	Adjusting Screw
R42...	C42-FIX	2	MS-19M-1	AS-18T9-1
	C42-ADJ	2	MS-19M-1	AS-18T9-1
SP42...	C42SP-FIX	2	MS-19M-1	AS-18T9-1
	C42SP-ADJ	2	MS-19M-1	AS-18T9-1

IC Inserts

Carbide Grade	Geometry	Part No.			Insert Screws
		AM300®	AM200®	TiN	
C5 (P35)	Standard	OP-05T308-P	OP-05T308-H	OP-05T308-T	IS-10-1
C1 (K35)	Standard	OP-05T308-1P	OP-05T308-1H	OP-05T308-1T	IS-10-1
C2 (K25)	Standard	OP-05T308-2P	OP-05T308-2H	-	IS-10-1
C5 (P35)	High Rake	OP-05T308-PHR	OP-05T308-HHR	-	IS-10-1

Key on A60: 1

A60: 22 - 23

A60: 2 - 4

Mounting screws sold in multiples of 4 | Adjusting screws sold in multiples of 4
 IC inserts sold in multiples of 10 | Insert screws sold in multiples of 10

i = Imperial (in)
m = Metric (mm)

Revolution Drill Holders

44 Series | Diameter Range: 2.600" - 2.800" (66.0mm - 71.1mm)

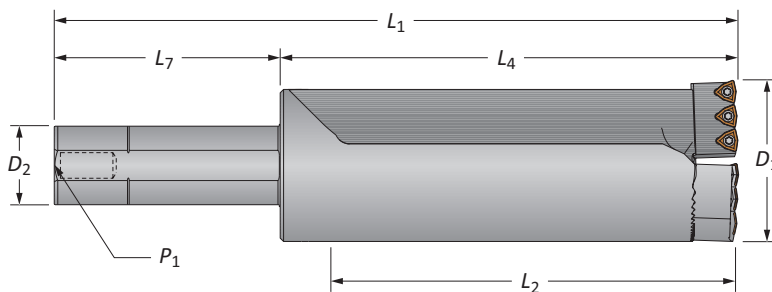

Straight Shank

Style	Length	D ₁ Range	Holder			Shank			Part No.	Cartridges
			L ₂	L ₄	L ₁	D ₂	L ₇	P ₁		
Standard	2.2xD	2.600 - 2.800	6-13/64	7-1/2	11-1/2	1-1/2	4	1/4	R44X22-150L	C44-...
Standard	3.5xD	2.600 - 2.800	9-61/64	11-1/4	15-1/4	1-1/2	4	1/4	R44X35-150L	C44-...
Stacked Plate	2.2xD	2.600 - 2.800	6-1/4	7-35/64	11-35/64	1-1/2	4	1/4	SP44X22-150L	C44SP-...
Standard	2.2xD	66.0 - 71.1	157.6	190.7	260.7	40	70	-	R44X22-40M	C44-...
Standard	3.5xD	66.0 - 71.1	252.9	285.9	355.9	40	70	-	R44X35-40M	C44-...
Stacked Plate	2.2xD	66.0 - 71.1	158.7	191.7	261.7	40	70	-	SP44X22-40M	C44SP-...

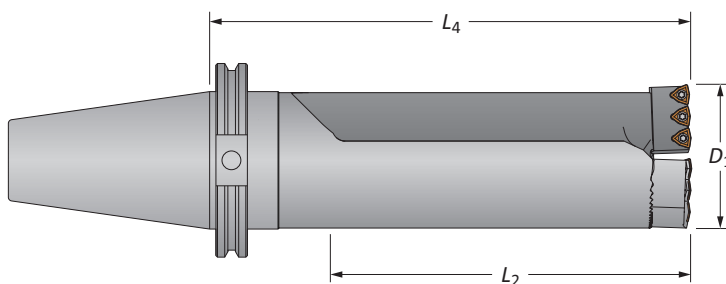

CV50 Shank

Style	Length	D ₁ Range	Holder		Shank	Part No.	Cartridges
			L ₂	L ₄			
Standard	2.2xD	2.600 - 2.800	6-13/64	8-7/8	CAT50	R44X22-CV50	C44-...
Standard	3.5xD	2.600 - 2.800	9-61/64	12-5/8	CAT50	R44X35-CV50	C44-...
Stacked Plate	2.2xD	2.600 - 2.800	6-1/4	8-59/64	CAT50	SP44X22-CV50	C44SP-...

Cartridges

Holder Part No.	Replacement Cartridges	Qty. Inserts Needed	Mounting Screw	Adjusting Screw
R44...	C44-FIX	3	MS-19M-1	AS-18T9-1
	C44-ADJ	3	MS-19M-1	AS-18T9-1
SP44...	C44SP-FIX	3	MS-19M-1	AS-18T9-1
	C44SP-ADJ	3	MS-19M-1	AS-18T9-1

IC Inserts

Carbide Grade	Geometry	Part No.			Insert Screws
		AM300®	AM200®	TiN	
C5 (P35)	Standard	OP-05T308-P	OP-05T308-H	OP-05T308-T	IS-10-1
C1 (K35)	Standard	OP-05T308-1P	OP-05T308-1H	OP-05T308-1T	IS-10-1
C2 (K25)	Standard	OP-05T308-2P	OP-05T308-2H	-	IS-10-1
C5 (P35)	High Rake	OP-05T308-PHR	OP-05T308-HHR	-	IS-10-1

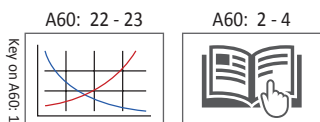

Mounting screws sold in multiples of 4 | Adjusting screws sold in multiples of 4
 IC inserts sold in multiples of 10 | Insert screws sold in multiples of 10
 i = Imperial (in) | m = Metric (mm)



Revolution Drill Holders

46 Series | Diameter Range: 2.800" - 3.000" (71.1mm - 76.2mm)

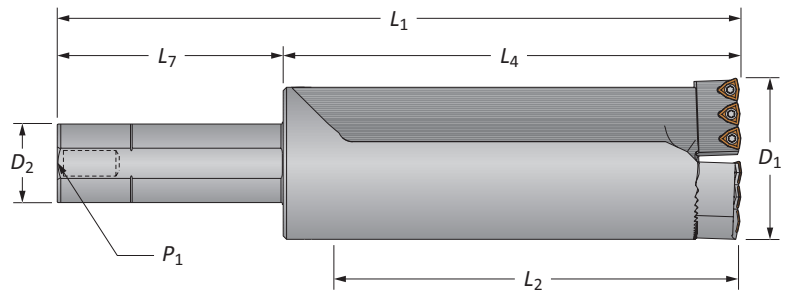

Straight Shank

Style	Length	D ₁ Range	Holder			Shank			Part No.	Cartridges	
			L ₂	L ₄	L ₁	D ₂	L ₇	P ₁			
i	Standard	2.2xD	2.800 - 3.000	6-45/64	8	12	1-1/2	4	1/4	R46X22-150L	C46-...
	Standard	3.5xD	2.800 - 3.000	10-29/64	11-3/4	15-3/4	1-1/2	4	1/4	R46X35-150L	C46-...
	Stacked Plate	2.2xD	2.800 - 3.000	6-3/4	8-3/64	12-3/64	1-1/2	4	1/4	SP46X22-150L	C46SP-...
m	Standard	2.2xD	71.1 - 76.2	170.4	203.4	273.4	40	70	-	R46X22-40M	C46-...
	Standard	3.5xD	71.1 - 76.2	265.6	298.6	368.6	40	70	-	R46X35-40M	C46-...
	Stacked Plate	2.2xD	71.1 - 76.2	171.4	204.4	274.4	40	70	-	SP46X22-40M	C46SP-...

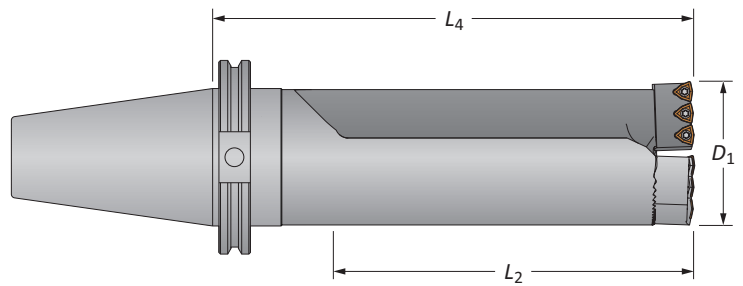

CV50 Shank

Style	Length	D ₁ Range	Holder		Shank	Part No.	Cartridges	
			L ₂	L ₄				
i	Standard	2.2xD	2.800 - 3.000	6-45/64	9-25/64	CAT50	R46X22-CV50	C46-...
	Standard	3.5xD	2.800 - 3.000	10-29/64	13-1/8	CAT50	R46X35-CV50	C46-...
	Stacked Plate	2.2xD	2.800 - 3.000	6-3/4	9-27/64	CAT50	SP46X22-CV50	C46SP-...

Cartridges

Holder Part No.	Replacement Cartridges	Qty. Inserts Needed	Mounting Screw	Adjusting Screw
R46...	C46-FIX	3	MS-21M-1	AS-18T9-1
	C46-ADJ	3	MS-21M-1	AS-18T9-1
SP46...	C46SP-FIX	3	MS-21M-1	AS-18T9-1
	C46SP-ADJ	3	MS-21M-1	AS-18T9-1

IC Inserts

Carbide Grade	Geometry	Part No.			Insert Screws
		AM300®	AM200®	TiN	
C5 (P35)	Standard	OP-05T308-P	OP-05T308-H	OP-05T308-T	IS-10-1
C1 (K35)	Standard	OP-05T308-1P	OP-05T308-1H	OP-05T308-1T	IS-10-1
C2 (K25)	Standard	OP-05T308-2P	OP-05T308-2H	-	IS-10-1
C5 (P35)	High Rake	OP-05T308-PHR	OP-05T308-HHR	-	IS-10-1

A60: 22 - 23

A60: 2 - 4

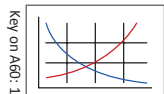

Mounting screws sold in multiples of 4 | Adjusting screws sold in multiples of 4
 IC inserts sold in multiples of 10 | Insert screws sold in multiples of 10

i = Imperial (in)
 m = Metric (mm)

Revolution Drill Holders

48 Series | Diameter Range: 3.000" - 3.200" (76.2mm - 81.3mm)

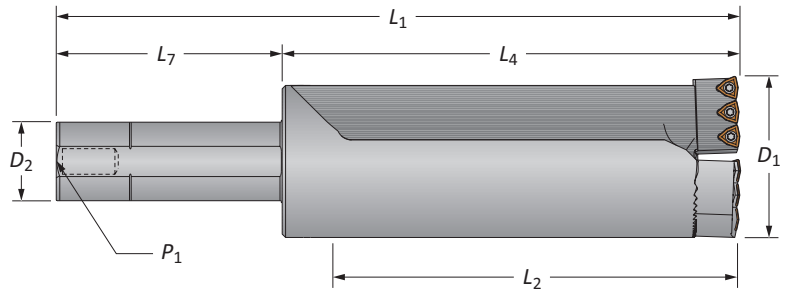

Straight Shank

Style	Length	D ₁ Range	Holder			Shank			Part No.	Cartridges
			L ₂	L ₄	L ₁	D ₂	L ₇	P ₁		
Standard	1.0xD	3.000 - 3.200	3-5/32	4-33/64	9-1/64	2	4-1/2	1/4	R48X10-200L	C48-...
Standard	2.5xD	3.000 - 3.200	7-29/32	9-17/64	13-49/64	2	4-1/2	1/4	R48X25-200L	C48-...
Stacked Plate	1.0xD	3.000 - 3.200	3-15/64	4-19/32	9-3/32	2	4-1/2	1/4	SP48X10-200L	C48SP-...
Stacked Plate	2.5xD	3.000 - 3.200	7-63/64	9-11/32	13-27/32	2	4-1/2	1/4	SP48X25-200L	C48SP-...
Standard	1.0xD	76.2 - 81.3	80.2	114.5	194.5	50	80	-	R48X10-50M	C48-...
Standard	2.5xD	76.2 - 81.3	200.9	235.2	315.2	50	80	-	R48X25-50M	C48-...
Stacked Plate	1.0xD	76.2 - 81.3	82.2	116.5	196.5	50	80	-	SP48X10-50M	C48SP-...
Stacked Plate	2.5xD	76.2 - 81.3	202.9	237.2	317.2	50	80	-	SP48X25-50M	C48SP-...

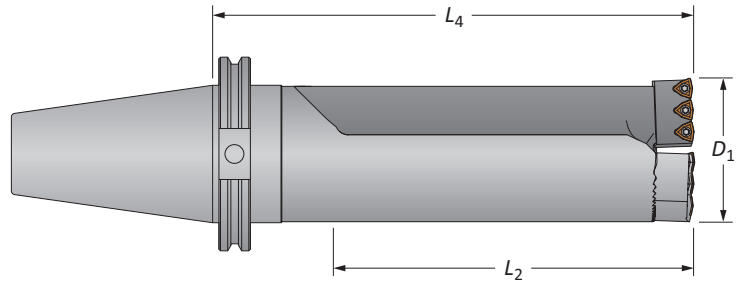

CV50 Shank

Style	Length	D ₁ Range	Holder		Shank	Part No.	Cartridges
			L ₂	L ₄			
Standard	1.0xD	3.000 - 3.200	3-5/32	5-57/64	CAT50	R48X10-CV50	C48-...
Standard	2.5xD	3.000 - 3.200	7-29/32	10-41/64	CAT50	R48X25-CV50	C48-...
Stacked Plate	1.0xD	3.000 - 3.200	3-15/64	5-31/32	CAT50	SP48X10-CV50	C48SP-...
Stacked Plate	2.5xD	3.000 - 3.200	7-63/64	10-23/32	CAT50	SP48X25-CV50	C48SP-...

Cartridges

Holder Part No.	Replacement Cartridges	Qty. Inserts Needed	Mounting Screw	Adjusting Screw
R48...	C48-FIX	3	MS-21M-1	AS-18T9-1
	C48-ADJ	3	MS-21M-1	AS-18T9-1
SP48...	C48SP-FIX	3	MS-21M-1	AS-18T9-1
	C48SP-ADJ	3	MS-21M-1	AS-18T9-1

IC Inserts

Carbide Grade	Geometry	Part No.			Insert Screws
		AM300®	AM200®	TiN	
C5 (P35)	Standard	OP-05T308-P	OP-05T308-H	OP-05T308-T	IS-10-1
C1 (K35)	Standard	OP-05T308-1P	OP-05T308-1H	OP-05T308-1T	IS-10-1
C2 (K25)	Standard	OP-05T308-2P	OP-05T308-2H	-	IS-10-1
C5 (P35)	High Rake	OP-05T308-PHR	OP-05T308-HHR	-	IS-10-1

A60: 22 - 23 A60: 2 - 4

Key on A60: 1

Mounting screws sold in multiples of 4 | Adjusting screws sold in multiples of 4
 IC inserts sold in multiples of 10 | Insert screws sold in multiples of 10

i = Imperial (in)
m = Metric (mm)



Revolution Drill Holders

52 Series | Diameter Range: 3.200" - 3.400" (81.3mm - 86.4mm)

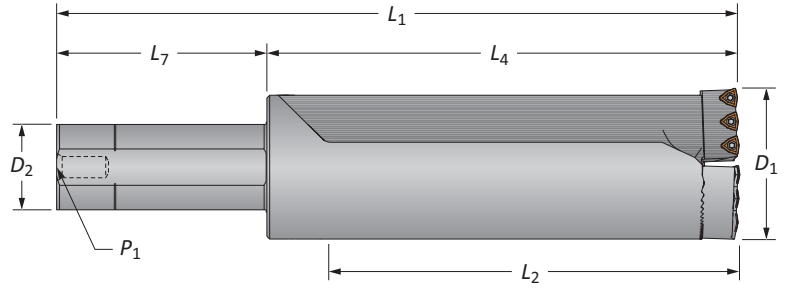

Straight Shank

	Style	Length	D ₁ Range	Holder			Shank			Part No.	Cartridges
				L ₂	L ₄	L ₁	D ₂	L ₇	P ₁		
i	Standard	1.0xD	3.200 - 3.400	3-27/64	5-1/64	9-33/64	2	4-1/2	1/4	R52X10-200L	C52-...
	Standard	2.5xD	3.200 - 3.400	8-27/64	10-1/64	14-33/64	2	4-1/2	1/4	R52X25-200L	C52-...
	Stacked Plate	1.0xD	3.200 - 3.400	3-31/64	5-5/64	9-37/64	2	4-1/2	1/4	SP52X10-200L	C52SP-...
	Stacked Plate	2.5xD	3.200 - 3.400	8-31/64	10-5/64	14-37/64	2	4-1/2	1/4	SP52X25-200L	C52SP-...
m	Standard	1.0xD	81.3 - 86.4	86.7	127.2	207.2	50	80	-	R52X10-50M	C52-...
	Standard	2.5xD	81.3 - 86.4	213.7	254.2	334.2	50	80	-	R52X25-50M	C52-...
	Stacked Plate	1.0xD	81.3 - 86.4	88.6	129.1	209.1	50	80	-	SP52X10-50M	C52SP-...
	Stacked Plate	2.5xD	81.3 - 86.4	215.6	256.1	336.1	50	80	-	SP52X25-50M	C52SP-...

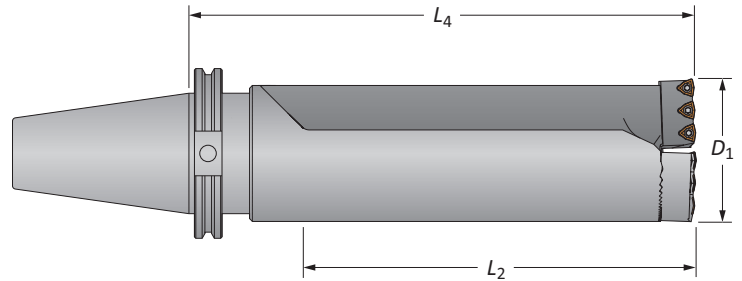

CV50 Shank

	Style	Length	D ₁ Range	Holder		Shank	Part No.	Cartridges
				L ₂	L ₄			
i	Standard	1.0xD	3.200 - 3.400	3-27/64	6-25/64	CAT50	R52X10-CV50	C52-...
	Standard	2.5xD	3.200 - 3.400	8-27/64	11-25/64	CAT50	R52X25-CV50	C52-...
	Stacked Plate	1.0xD	3.200 - 3.400	3-31/64	6-29/64	CAT50	SP52X10-CV50	C52SP-...
	Stacked Plate	2.5xD	3.200 - 3.400	8-31/64	11-29/64	CAT50	SP52X25-CV50	C52SP-...

Cartridges

Holder Part No.	Replacement Cartridges	Qty. Inserts Needed	Mounting Screw	Adjusting Screw
R52...	C52-FIX	3	MS-19M-1	AS-18T9-1
	C52-ADJ	3	MS-19M-1	AS-18T9-1
SP52...	C52SP-FIX	3	MS-19M-1	AS-18T9-1
	C52SP-ADJ	3	MS-19M-1	AS-18T9-1

IC Inserts

Carbide Grade	Geometry	Part No.			Insert Screws
		AM300®	AM200®	TiN	
C5 (P35)	Standard	OP-05T308-P	OP-05T308-H	OP-05T308-T	IS-10-1
C1 (K35)	Standard	OP-05T308-1P	OP-05T308-1H	OP-05T308-1T	IS-10-1
C2 (K25)	Standard	OP-05T308-2P	OP-05T308-2H	-	IS-10-1
C5 (P35)	High Rate	OP-05T308-PHR	OP-05T308-HHR	-	IS-10-1

A60: 22 - 23

A60: 2 - 4

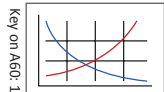

Mounting screws sold in multiples of 4 | Adjusting screws sold in multiples of 4
 IC inserts sold in multiples of 10 | Insert screws sold in multiples of 10

i = Imperial (in)
 m = Metric (mm)

Revolution Drill Holders

54 Series | Diameter Range: 3.400" - 3.600" (86.4mm - 91.4mm)

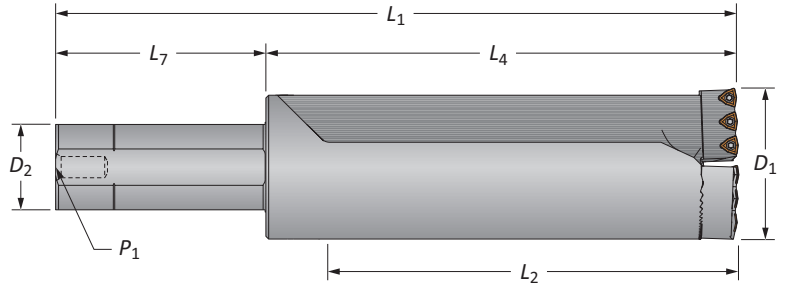

Straight Shank

Style	Length	D ₁ Range	Holder			Shank			Part No.	Cartridges
			L ₂	L ₄	L ₁	D ₂	L ₇	P ₁		
Standard	1.0xD	3.400 - 3.600	3-21/32	5-17/64	9-49/64	2	4-1/2	1/4	R54X10-200L	C54-...
Standard	2.5xD	3.400 - 3.600	8-29/32	10-33/64	15-1/64	2	4-1/2	1/4	R54X25-200L	C54-...
Stacked Plate	1.0xD	3.400 - 3.600	3-23/32	5-21/64	9-53/64	2	4-1/2	1/4	SP54X10-200L	C54SP-...
Stacked Plate	2.5xD	3.400 - 3.600	8-31/32	10-37/64	15-5/64	2	4-1/2	1/4	SP54X25-200L	C54SP-...
Standard	1.0xD	86.4 - 91.4	92.9	133.6	213.6	50	80	-	R54X10-50M	C54-...
Standard	2.5xD	86.4 - 91.4	226.3	266.9	346.9	50	80	-	R54X25-50M	C54-...
Stacked Plate	1.0xD	86.4 - 91.4	94.5	135.1	215.1	50	80	-	SP54X10-50M	C54SP-...
Stacked Plate	2.5xD	86.4 - 91.4	227.8	268.5	348.5	50	80	-	SP54X25-50M	C54SP-...

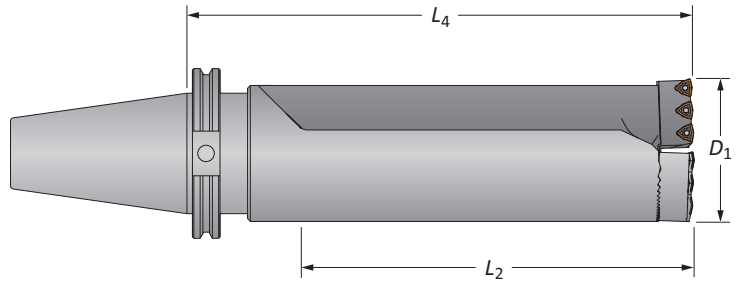

CV50 Shank

Style	Length	D ₁ Range	Holder		Shank	Part No.	Cartridges
			L ₂	L ₄			
Standard	1.0xD	3.400 - 3.600	3-21/32	6-41/64	CAT50	R54X10-CV50	C54-...
Standard	2.5xD	3.400 - 3.600	8-29/32	11-57/64	CAT50	R54X25-CV50	C54-...
Stacked Plate	1.0xD	3.400 - 3.600	3-23/32	6-11/16	CAT50	SP54X10-CV50	C54SP-...
Stacked Plate	2.5xD	3.400 - 3.600	8-31/32	11-15/16	CAT50	SP54X25-CV50	C54SP-...

Cartridges

Holder Part No.	Replacement Cartridges	Qty. Inserts Needed	Mounting Screw	Adjusting Screw
R54...	C54-FIX	3	MS-19M-1	AS-18T9-1
	C54-ADJ	3	MS-19M-1	AS-18T9-1
SP54...	C54SP-FIX	3	MS-19M-1	AS-18T9-1
	C54SP-ADJ	3	MS-19M-1	AS-18T9-1

IC Inserts

Carbide Grade	Geometry	Part No.			Insert Screws
		AM300®	AM200®	TiN	
C5 (P35)	Standard	OP-05T308-P	OP-05T308-H	OP-05T308-T	IS-10-1
C1 (K35)	Standard	OP-05T308-1P	OP-05T308-1H	OP-05T308-1T	IS-10-1
C2 (K25)	Standard	OP-05T308-2P	OP-05T308-2H	-	IS-10-1
C5 (P35)	High Rake	OP-05T308-PHR	OP-05T308-HHR	-	IS-10-1

A60: 22 - 23 A60: 2 - 4

Key on A60: 1

Mounting screws sold in multiples of 4 | Adjusting screws sold in multiples of 4
 IC inserts sold in multiples of 10 | Insert screws sold in multiples of 10

i = Imperial (in)
m = Metric (mm)



Revolution Drill Holders

56 Series | Diameter Range: 3.600" - 3.800" (91.4mm - 96.5mm)

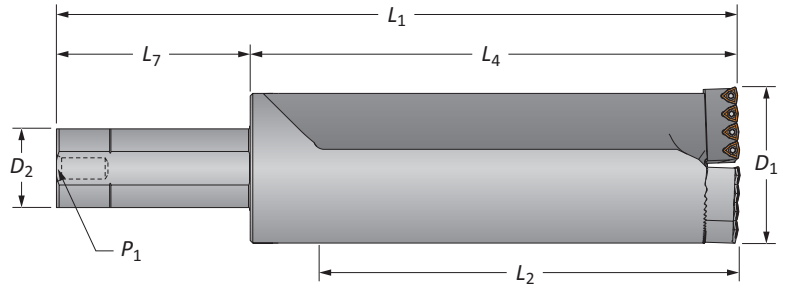

Straight Shank

	Style	Length	D ₁ Range	Holder			Shank			Part No.	Cartridges
				L ₂	L ₄	L ₁	D ₂	L ₇	P ₁		
i	Standard	1.0xD	3.600 - 3.800	3-7/8	5-3/4	10-1/4	2	4-1/2	1/4	R56X10-200L	C56-...
	Standard	2.5xD	3.600 - 3.800	9-3/8	11-1/4	15-3/4	2	4-1/2	1/4	R56X25-200L	C56-...
	Stacked Plate	1.0xD	3.600 - 3.800	3-15/16	5-13/16	10-5/16	2	4-1/2	1/4	SP56X10-200L	C56SP-...
	Stacked Plate	2.5xD	3.600 - 3.800	9-7/16	11-5/16	15-13/16	2	4-1/2	1/4	SP56X25-200L	C56SP-...
m	Standard	1.0xD	91.4 - 96.5	98.6	146.2	226.2	50	80	-	R56X10-50M	C56-...
	Standard	2.5xD	91.4 - 96.5	238.3	285.9	365.9	50	80	-	R56X25-50M	C56-...
	Stacked Plate	1.0xD	91.4 - 96.5	99.9	147.6	227.6	50	80	-	SP56X10-50M	C56SP-...
	Stacked Plate	2.5xD	91.4 - 96.5	239.6	287.3	367.3	50	80	-	SP56X25-50M	C56SP-...

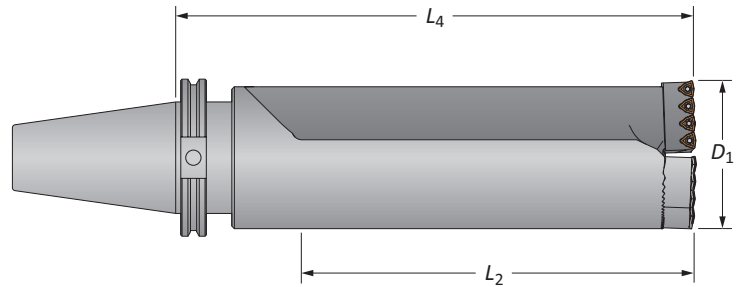

CV50 Shank

	Style	Length	D ₁ Range	Holder		Shank	Part No.	Cartridges
				L ₂	L ₄			
i	Standard	1.0xD	3.600 - 3.800	3-7/8	7-1/8	CAT50	R56X10-CV50	C56-...
	Standard	2.5xD	3.600 - 3.800	9-3/8	12-5/8	CAT50	R56X25-CV50	C56-...
	Stacked Plate	1.0xD	3.600 - 3.800	3-15/16	7-3/16	CAT50	SP56X10-CV50	C56SP-...
	Stacked Plate	2.5xD	3.600 - 3.800	9-7/16	12-11/16	CAT50	SP56X25-CV50	C56SP-...

Cartridges

Holder Part No.	Replacement Cartridges	Qty. Inserts Needed	Mounting Screw	Adjusting Screw
R56...	C56-FIX	4	MS-21M-1	AS-18T9-1
	C56-ADJ	4	MS-21M-1	AS-18T9-1
SP56...	C56SP-FIX	4	MS-21M-1	AS-18T9-1
	C56SP-ADJ	4	MS-21M-1	AS-18T9-1

IC Inserts

Carbide Grade	Geometry	Part No.			Insert Screws
		AM300®	AM200®	TiN	
C5 (P35)	Standard	OP-05T308-P	OP-05T308-H	OP-05T308-T	IS-10-1
C1 (K35)	Standard	OP-05T308-1P	OP-05T308-1H	OP-05T308-1T	IS-10-1
C2 (K25)	Standard	OP-05T308-2P	OP-05T308-2H	-	IS-10-1
C5 (P35)	High Rake	OP-05T308-PHR	OP-05T308-HHR	-	IS-10-1

A60: 22 - 23

A60: 2 - 4

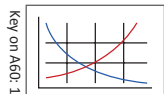

Mounting screws sold in multiples of 4 | Adjusting screws sold in multiples of 4
 IC inserts sold in multiples of 10 | Insert screws sold in multiples of 10

i = Imperial (in)
 m = Metric (mm)

Revolution Drill Holders

58 Series | Diameter Range: 3.800" - 4.000" (96.5mm - 101.6mm)

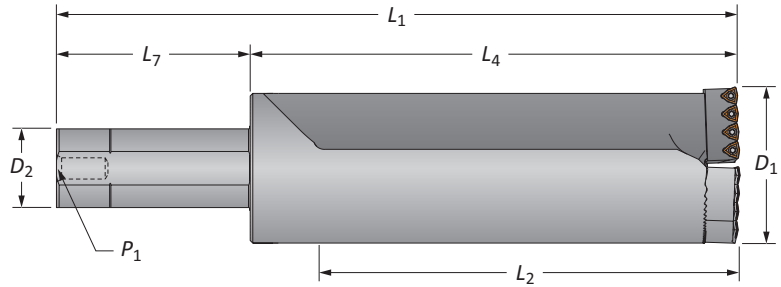

Straight Shank

Style	Length	D ₁ Range	Holder			Shank			Part No.	Cartridges
			L ₂	L ₄	L ₁	D ₂	L ₇	P ₁		
Standard	1.0xD	3.800 - 4.000	3-7/8	5-3/4	10-1/4	2	4-1/2	1/4	R58X10-200L	C58-...
Standard	2.5xD	3.800 - 4.000	9-7/8	11-3/4	16-1/4	2	4-1/2	1/4	R58X25-200L	C58-...
Stacked Plate	1.0xD	3.800 - 4.000	3-15/16	5-13/16	10-5/16	2	4-1/2	1/4	SP58X10-200L	C58SP-...
Stacked Plate	2.5xD	3.800 - 4.000	9-15/16	11-13/16	16-5/16	2	4-1/2	1/4	SP58X25-200L	C58SP-...
Standard	1.0xD	96.5 - 101.6	98.6	146.2	226.2	50	80	-	R58X10-50M	C58-...
Standard	2.5xD	96.5 - 101.6	251.0	298.6	378.6	50	80	-	R58X25-50M	C58-...
Stacked Plate	1.0xD	96.5 - 101.6	99.8	147.4	227.4	50	80	-	SP58X10-50M	C58SP-...
Stacked Plate	2.5xD	96.5 - 101.6	252.2	299.8	379.8	50	80	-	SP58X25-50M	C58SP-...

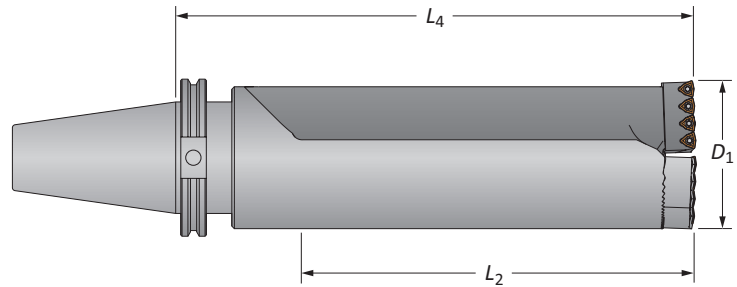

CV50 Shank

Style	Length	D ₁ Range	Holder		Shank	Part No.	Cartridges
			L ₂	L ₄			
Standard	1.0xD	3.800 - 4.000	3-7/8	7-1/8	CAT50	R58X10-CV50	C58-...
Standard	2.5xD	3.800 - 4.000	9-7/8	13-1/8	CAT50	R58X25-CV50	C58-...
Stacked Plate	1.0xD	3.800 - 4.000	3-15/16	7-3/16	CAT50	SP58X10-CV50	C58SP-...
Stacked Plate	2.5xD	3.800 - 4.000	9-15/16	13-3/16	CAT50	SP58X25-CV50	C58SP-...

Cartridges

Holder Part No.	Replacement Cartridges	Qty. Inserts Needed	Mounting Screw	Adjusting Screw
R58...	C58-FIX	4	MS-21M-1	AS-18T9-1
	C58-ADJ	4	MS-21M-1	AS-18T9-1
SP58...	C58SP-FIX	4	MS-21M-1	AS-18T9-1
	C58SP-ADJ	4	MS-21M-1	AS-18T9-1

IC Inserts

Carbide Grade	Geometry	Part No.			Insert Screws
		AM300®	AM200®	TiN	
C5 (P35)	Standard	OP-05T308-P	OP-05T308-H	OP-05T308-T	IS-10-1
C1 (K35)	Standard	OP-05T308-1P	OP-05T308-1H	OP-05T308-1T	IS-10-1
C2 (K25)	Standard	OP-05T308-2P	OP-05T308-2H	-	IS-10-1
C5 (P35)	High Rake	OP-05T308-PHR	OP-05T308-HHR	-	IS-10-1

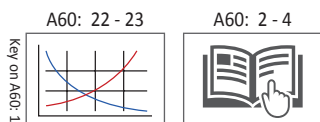

Mounting screws sold in multiples of 4 | Adjusting screws sold in multiples of 4
 IC inserts sold in multiples of 10 | Insert screws sold in multiples of 10

i = Imperial (in)
m = Metric (mm)



This page left intentionally blank

A

DRILLING

B

BORING

C

REAMING

D

BURNISHING



E

THREADING

X

SPECIALS

Recommended Cutting Data | Imperial (inch)

ISO	Material	Hardness (BHN)	Speed (SFM)			Feed Rate (IPR)
			 AM300®	 AM200®	 TiN	
P	Free Machining Steel 1118, 1215, 12L14, etc.	100 - 250	900 - 1300	850 - 1200	700 - 900	.0035 - .007
	Low Carbon Steel 1010, 1020, 1025, 1522, 1144, etc.	85 - 275	850 - 1250	800 - 1150	650 - 850	.003 - .0065
	Medium Carbon Steel 1030, 1040, 1050, 1527, 1140, 1151, etc.	125 - 325	800 - 1050	750 - 950	600 - 850	.0035 - .0065
	Alloy Steel 4140, 5140, 8640, etc.	125 - 375	750 - 1000	700 - 900	600 - 850	.0035 - .0065
	High Strength Alloy 4340, 4330V, 300M, etc.	225 - 400	600 - 850	550 - 750	400 - 650	.003 - .005
	Structural Steel A36, A285, A516, etc.	100 - 350	850 - 1050	800 - 950	650 - 850	.003 - .0065
	Tool Steel H-13, H-21, A-4, O-2, S-3, etc.	150 - 250	400 - 800	350 - 700	250 - 650	.0025 - .005
S	High Temp Alloy Hastelloy B, Inconel 600, etc.	140 - 310	250 - 450	250 - 350	150 - 300	.0025 - .005
M	Stainless Steel 400 Series 416, 420, etc.	185 - 350	600 - 850	550 - 750	400 - 650	.003 - .006
	Stainless Steel 300 Series 304, 316, 17-4PH, etc.	135 - 275	600 - 850	550 - 750	400 - 650	.003 - .006
	Super Duplex Stainless Steel	135 - 275	500 - 750	450 - 650	300 - 550	.002 - .005
K	Nodular, Grey, Ductile Cast Iron	120 - 320	700 - 900	650 - 800	500 - 700	.004 - .008
N	Cast Aluminum	30 - 180	1250 - 1650	1200 - 1550	950 - 1100	.006 - .012
	Wrought Aluminum	30 - 180	1250 - 1650	1200 - 1550	950 - 1100	.006 - .012
	Brass	30 - 100	950 - 1350	900 - 1250	750 - 1100	.005 - .009

Material Constants

Type of Material	Hardness (BHN)	K _m (lbs/in ²)
Free Machining Steel	100 - 250	0.75
Low Carbon Steel	85 - 275	0.85
Medium Carbon Steel	125 - 325	0.90
Alloy Steel	125 - 375	1.00
High Strength Steel	225 - 400	1.15
Structural Steel	100 - 350	1.00
Tool Steel	150 - 250	0.90
High Temperature Alloy	140 - 310	1.44
Titanium Alloy	140 - 310	0.72
Aerospace Alloy	185 - 350	0.70
Stainless Steel 400 Series	185 - 350	1.08
Stainless Steel 300 Series	135 - 275	0.94
Super Duplex Stainless Steel	135 - 275	0.94
Wear Plate	400 - 600	1.60
Hardened Steel	300 - 500	1.40
Nodular, Ductile Cast Iron	120 - 320	0.65
Grey Cast Iron	120 - 320	0.75
Cast Aluminum	30 - 180	0.40
Wrought Aluminum	30 - 180	0.40
Aluminum Bronze	100 - 250	0.50
Brass	100	0.35
Copper	60	0.30



Formulas

1.	RPM = $(3.82 \cdot \text{SFM}) / \text{DIA}$ where: RPM = revolutions per minute (rev/min) SFM = speed (ft/min) DIA = diameter of drill (inch)
2.	HP = $(0.6676 \cdot \text{DIA}^2 \cdot \text{IPR} \cdot \text{RPM} \cdot K_m) / 0.80$ where: Tool Power = tool power (HP) DIA = diameter of drill (inch) IPR = feed rate (in/rev) RPM = revolutions per minute (rev/min) K _m = specific cutting energy (lbs/in ²) machine efficiency (using 0.80 as constant)
3.	Thrust = $148,500 \cdot \text{IPR} \cdot \text{DIA} \cdot K_m$ where: Thrust = axial thrust (lbs) IPR = feed rate (in/rev) DIA = diameter of drill (inch) K _m = specific cutting energy (lbs/in ²)
5.	Torque = $(\text{HP} \cdot 5252) / \text{RPM}$ where: Torque = torque (ft/lbs) HP = tool power (HP) RPM = revolutions per minute (rev/min)

The table and equations on this page are found in the *Machinery's Handbook*. Permission to simplify and print the equations is granted by the Editor of the *Machinery's Handbook*.

IMPORTANT: The speeds and feeds listed above are considered a general starting point for all applications. Factory technical assistance is available for your specific applications through our Application Engineering department.

Recommended Cutting Data | Metric (mm)

ISO	Material	Hardness (BHN)	Speed (M/min)			Feed Rate (mm/rev)
			 AM300®	 AM200®	 TiN	
P	Free Machining Steel 1118, 1215, 12L14, etc.	100 - 250	274 - 396	259 - 366	213 - 274	0.09 - 0.18
	Low Carbon Steel 1010, 1020, 1025, 1522, 1144, etc.	85 - 275	259 - 381	244 - 351	198 - 259	0.08 - 0.17
	Medium Carbon Steel 1030, 1040, 1050, 1527, 1140, 1151, etc.	125 - 325	244 - 320	229 - 290	183 - 259	0.09 - 0.17
	Alloy Steel 4140, 5140, 8640, etc.	125 - 375	229 - 305	213 - 274	183 - 259	0.09 - 0.17
	High Strength Alloy 4340, 4330V, 300M, etc.	225 - 400	183 - 259	168 - 229	122 - 198	0.08 - 0.13
	Structural Steel A36, A285, A516, etc.	100 - 350	259 - 320	244 - 290	198 - 259	0.08 - 0.17
	Tool Steel H-13, H-21, A-4, O-2, S-3, etc.	150 - 250	122 - 244	107 - 213	76 - 198	0.06 - 0.13
S	High Temp Alloy Hastelloy B, Inconel 600, etc.	140 - 310	76 - 137	76 - 107	46 - 91	0.06 - 0.11
M	Stainless Steel 400 Series 416, 420, etc.	185 - 350	183 - 259	168 - 229	122 - 198	0.08 - 0.15
	Stainless Steel 300 Series 304, 316, 17-4PH, etc.	135 - 275	183 - 259	168 - 229	122 - 198	0.08 - 0.15
	Super Duplex Stainless Steel	135 - 275	152 - 228	137 - 198	91 - 152	0.05 - 0.12
K	Nodular, Grey, Ductile Cast Iron	120 - 320	213 - 274	198 - 244	152 - 213	0.10 - 0.20
N	Cast Aluminum	30 - 180	381 - 503	381 - 472	290 - 335	0.15 - 0.30
	Wrought Aluminum	30 - 180	381 - 503	381 - 472	290 - 335	0.15 - 0.30
	Brass	30 - 100	290 - 411	274 - 381	229 - 335	0.13 - 0.23

Material Constants

Type of Material	Hardness (BHN)	K _m (lbs/in ²)
Free Machining Steel	100 - 250	5.17
Low Carbon Steel	85 - 275	5.86
Medium Carbon Steel	125 - 325	6.21
Alloy Steel	125 - 375	6.90
High Strength Steel	225 - 400	7.93
Structural Steel	100 - 350	6.90
Tool Steel	150 - 250	6.21
High Temperature Alloy	140 - 310	9.93
Titanium Alloy	140 - 310	4.97
Aerospace Alloy	185 - 350	4.48
Stainless Steel 400 Series	185 - 350	7.45
Stainless Steel 300 Series	135 - 275	6.48
Super Duplex Stainless Steel	135 - 275	6.48
Wear Plate	400 - 600	11.04
Hardened Steel	300 - 500	9.66
Nodular, Ductile Cast Iron	120 - 320	4.48
Grey Cast Iron	120 - 320	5.17
Cast Aluminum	30 - 180	2.76
Wrought Aluminum	30 - 180	2.76
Aluminum Bronze	100 - 250	3.45
Brass	100	2.41
Copper	60	2.07

Formulas

1. RPM	= (318.31 • M/min) / DIA where: RPM = revolutions per minute (rev/min) M/min = speed (M/min) DIA = diameter of drill (mm)
2. kW	= (DIA² • mm/rev • RPM • K_m) / 181,018 where: kW = tool power (kW) DIA = diameter of drill (mm) mm/rev = feed rate (mm/rev) RPM = revolutions per minute (rev/min) K _m = specific cutting energy (kPa) machine efficiency (using 181,018 as constant)
3. Thrust	= 148.78 • mm/rev • DIA • K_m where: Thrust = axial thrust (N) mm/rev = feed rate (mm/rev) DIA = diameter of drill (mm) K _m = specific cutting energy (kPa)
5. Torque	= (kW • 9549.3) / RPM where: Torque = torque (Nm) HP = tool power (kW) RPM = revolutions per minute (rev/min)

The table and equations on this page are found in the *Machinery's Handbook*. Permission to simplify and print the equations is granted by the Editor of the *Machinery's Handbook*.

IMPORTANT: The speeds and feeds listed above are considered a general starting point for all applications. Factory technical assistance is available for your specific applications through our Application Engineering department.

A
DRILLING
B
BORING
C
REAMING
D
BURNISHING
E
THREADING
X
SPECIALS

Opening Drill®

Large Diameter Replaceable IC Insert Drilling System

► Diameter Range: 2.000" - 5.620" (50.8mm - 142.8mm)



Need larger holes? No problem.

The Opening Drill is an extremely effective tool designed to enlarge existing holes. It is available in nine different shank styles: Straight, ABS 63, CAT V40, CAT V50, HSK 63A/C, HSK 100A/C, BT 40, BT 50, and DIN50.

In a *single* operation, an existing hole can be opened and large amounts of material can be removed. The insert design reduces chip size and improves evacuation. Also, inventory and cost are reduced by the adjustable diameters.

Excellent chip control	Improves hole quality and surface finish	Provides maximum durability and stability
------------------------	--	---

Applicable Industries

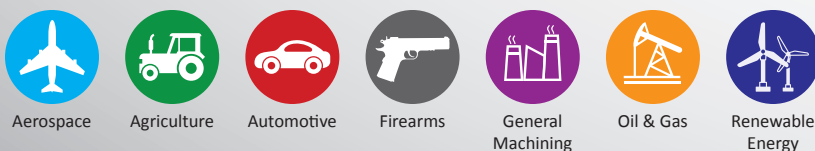

Your safety and the safety of others is very important. This catalog contains important safety messages. Always read and follow all safety precautions.



This triangle is a safety hazard symbol. It alerts you to potential safety hazards that can cause tool failure and serious injury.

When you see this symbol in the catalog, look for a related safety message that may be near this triangle or referred to in the nearby text.

There are safety signal words also used in the catalog. Safety messages follow these words.

WARNING

WARNING (shown above) means that failure to follow the precautions in this message could result in tool failure and serious injury.

NOTICE means that failure to follow the precautions in this message could result in damage to the tool or machine but not result in personal injury.

NOTE and **IMPORTANT** are also used. These are important that you read and follow but are not safety-related.

Visit www.alliedmachine.com for the most up-to-date information and procedures.

Reference Icons

The following icons will appear throughout the catalog to help you navigate between products.



Setup / Assembly Information

Detailed instructions and information regarding the corresponding part(s)

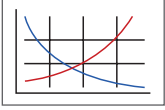

Recommended Cutting Data

Speed and feed recommendations for optimum and safe drilling

Series	Diameter Range	
	Imperial (inch)	Metric (mm)
OP1	2.00 - 2.50	50.8 - 63.5
OP2	2.50 - 3.00	63.5 - 76.2
OP3	3.00 - 4.12	76.2 - 104.7
OP4	4.12 - 5.62	104.7 - 142.8

Introduction Information

Product Overview	2
Set-up Instructions	3
Product Nomenclature	4

Drill Shank Style

Straight	5
CAT40	6
CAT50	7
BT40	8
BT50	9
HSK63	10
HSK100	11
ABS63	12
DIN50	13

Recommended Cutting Data

Imperial (inch)	14 - 15
Metric (mm)	16 - 17

Product Overview

Features

- Can be used as a rotating or stationary tool
- Can be used in rough boring operations
- Available in multiple different shanks (see chart below)
- Smooth cutting action and quiet operations in lathes and mills
- Special lengths, diameters, and shanks are available upon request

Advantages

- Opens an existing hole in a single operation
- Ignores core shifts up to 1/8" (3.175mm) providing straight and true holes without the need for boring
- Allows for large amounts of material removal
- Unique design enables larger holes to be made on low horsepower machines
- Replaceable cartridges protect your investment
- Adjustable diameters reduce inventory and cost

Shank Options



Straight



CAT40



CAT50



BT40



BT50



HSK63



HSK100



DIN50



ABS63



AM300°



AM200°



TiN

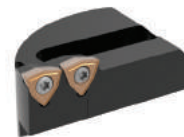

2 Inserts
(OP1 - OP3 series)



3 Inserts
(OP4 series)

Insert Application Recommendations

Carbide Grade Options

C5 (P35)	General purpose carbide grade suitable for most applications. ▶ <i>Common application in steels and stainless steels.</i>
C1 (K35)	Toughest carbide grade. Provides the best combination of edge strength and tool life. ▶ <i>Recommended for less rigid applications.</i>
C2 (K25)	Higher wear resistant carbide suitable for abrasive material applications. ▶ <i>Recommended for grey, ductile, and nodular irons.</i>

Additional Geometry Option

High Rake (HR)	Provides superior chip control and tool life in long chipping carbon and alloy steels below 200 Bhn.
----------------	--

IC Inserts

- The design allows for excellent chip control and aggressive penetration rates
- The proprietary AM200° and AM300° coatings increase tool life above competitors' premium coatings
- The same inserts are used for both Revolution Drill and Opening Drill products

Set-up Instructions



Step 1:
Loosen the mounting screws on both cartridges.



Step 2:
Set one cartridge to the finish diameter by tightening the adjustment screw against the adjustment pin.



Step 3:
Tighten the mounting screws on the cartridge to 11-14 ft-lbf (15-19 N-m).

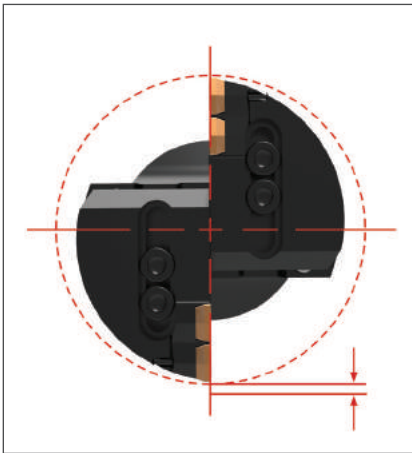

Step 4:
Set the opposing cartridge with 0.160" to 0.200" radial offset inward by tightening the adjustment screw against the adjustment pin (optimum situation for each insert to remove equal material).



Step 5:
Tighten the mounting screws on the cartridge to 11-14 ft-lbf (15-19 N-m).

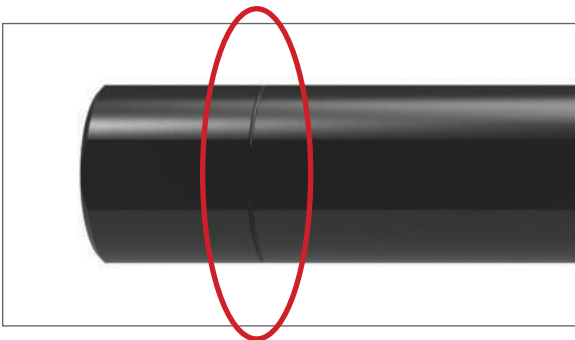

Straight Shanks

- Designed for lathe applications
- Can be cut off for use in end-mill holders
- The score mark (circled to the left) is provided for recommended cut length
- Cut and deburr at the score mark
- This improves rigidity when the body sits against the face of an end-mill holder



Product Nomenclature

Opening Drill Holders

OP1	-	1S	-	SS1.5
1		2		3

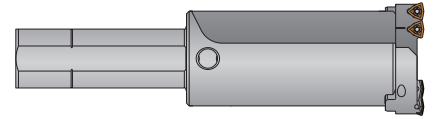

1. Series	2. Length	3. Shank Type	
OP1 = 2.00" - 2.50" (50.8mm - 63.5mm) OP2 = 2.50" - 3.00" (63.5mm - 76.2mm) OP3 = 3.00" - 4.12" (76.2mm - 104.7mm) OP4 = 4.12" - 5.62" (104.7mm - 142.8mm)	1S = Short 1L = Long	SS1.5 = 1-1/2 ϕ straight SS2.5 = 2-1/2 ϕ straight 40M = 40mm straight 50M = 50mm straight CV40 = CAT40 CV50 = CAT50	BT40 = BT40 BT50 = BT50 HSK63 = HSK 63A/C HSK100 = HSK 100A/C ABS63 = ABS63 DV50 = DIN50

Opening Drill Inserts

OP	-	05	T3	08	-	1	H	HR
1		2	3	4		5	6	7

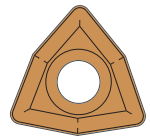

1. Compatible with:	2. IC Type	3. Thickness	4. Radius	5. Carbide Grade
Opening Drill Revolution Drill	05 = 5/16"	T3 = 5/32"	08 = 1/32"	Blank = C5 (P35) 1 = C1 (K35) 2 = C2 (K25)
6. Coating	7. Geometry			
P = AM300® H = AM200® T = TiN A = TiAlN N = TiCN U = Uncoated	Blank = General Purpose HR = High Rake			

Reference Key

Symbol	Attribute
D_1	Drill diameter range
D_2	Shank diameter
D_3	Body diameter
L_1	Overall length
L_2	Maximum drill depth
L_4	Holder length
L_7	Shank length
P_1	Rear pipe tap

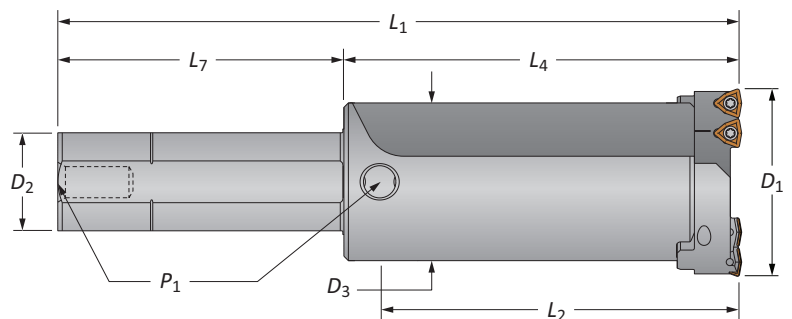

A DRILLING
B BORING
C REAMING
D BURNISHING
E THREADING
X SPECIALS

Opening Drill Holders

Straight Shank | Diameter Range: 2.00" - 5.62" (50.8mm - 142.8mm)

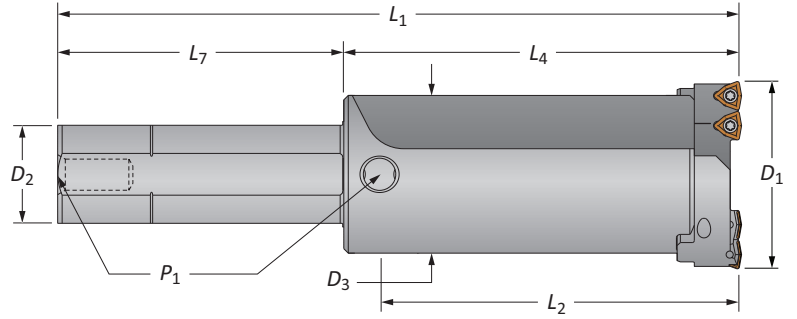

Holders

	Length	D ₁ Range	Holder			Shank			Part No.	Cartridges	
			D ₃	L ₂	L ₄	L ₁	D ₂	L ₇			P ₁
i	Short	2.00 - 2.50	1.840	3-9/32	4-3/64	8-3/64	1-1/2	4	1/4 NPT	OP1-1S-SS1.5	OP1-WC05
	Long	2.00 - 2.50	1.840	5-17/32	6-19/64	10-19/64	1-1/2	4	1/4 NPT	OP1-1L-SS1.5	OP1-WC05
	Short	2.50 - 3.00	2.220	4-43/64	5-1/2	9-1/2	1-1/2	4	1/4 NPT	OP2-1S-SS1.5	OP2-WC05
	Long	2.50 - 3.00	2.220	7-43/64	8-1/2	12-1/2	1-1/2	4	1/4 NPT	OP2-1L-SS1.5	OP2-WC05
	Short	3.00 - 4.12	2.806	5-7/64	6	10	1-1/2	4	1/4 NPT	OP3-1S-SS1.5	OP3-WC05
	Long	3.00 - 4.12	2.806	9-7/64	10	14	1-1/2	4	1/4 NPT	OP3-1L-SS1.5	OP3-WC05
	Short	4.12 - 5.62	3.500	5-1/64	6	10-1/2	2	4-1/2	1/4 NPT	OP4-1S-SS2.0	OP4-WC05
	Long	4.12 - 5.62	3.500	10-33/64	11-1/2	16	2	4-1/2	1/4 NPT	OP4-1L-SS2.0	OP4-WC05
m	Short	50.8 - 63.5	1.840	83.5	102.9	172.9	40	70	-	OP1-1S-40M	OP1-WC05
	Long	50.8 - 63.5	1.840	140.6	160.1	230.1	40	70	-	OP1-1L-40M	OP1-WC05
	Short	63.5 - 76.2	2.220	118.5	139.8	209.8	40	70	-	OP2-1S-40M	OP2-WC05
	Long	63.5 - 76.2	2.220	194.7	216.0	286.0	40	70	-	OP2-1L-40M	OP2-WC05
	Short	76.2 - 104.7	2.806	129.9	152.5	222.5	40	70	-	OP3-1S-40M	OP3-WC05
	Long	76.2 - 104.7	2.806	231.5	254.1	324.1	40	70	-	OP3-1L-40M	OP3-WC05
	Short	104.7 - 142.8	3.500	127.4	152.5	232.5	50	80	-	OP4-1S-50M	OP4-WC05
	Long	104.7 - 142.8	3.500	254.4	292.2	372.2	50	80	-	OP4-1L-50M	OP4-WC05

Cartridges

Replacement Cartridges	Qty. Inserts Needed	Mounting Screw	Adjusting Screw
OP1-WC05	2	MS-13M-1	AS-10T9-1
OP2-WC05	2	MS-15M-1	AS-10T9-1
OP3-WC05	2	MS-15M-1	AS-12T9-1
OP4-WC05	3	MS-15M-1	AS-14T9-1

IC Inserts

Carbide Grade	Geometry	Part No.			Insert Screws
		AM300®	AM200®	TiN	
C5 (P35)	Standard	OP-05T308-P	OP-05T308-H	OP-05T308-T	IS-10-1
C1 (K35)	Standard	OP-05T308-1P	OP-05T308-1H	OP-05T308-1T	IS-10-1
C2 (K25)	Standard	OP-05T308-2P	OP-05T308-2H	-	IS-10-1
C5 (P35)	High Rake	OP-05T308-PHR	OP-05T308-HHR	-	IS-10-1

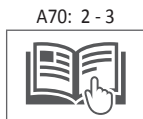
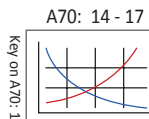

Mounting screws sold in multiples of 4 | Adjusting screws sold in multiples of 4
 IC inserts sold in multiples of 10 | Insert screws sold in multiples of 10

i = Imperial (in)
 m = Metric (mm)

A
DRILLING
B
BORING
C
REAMING
D
BURNISHING
E
THREADING
X
SPECIALS

Opening Drill Holders

CAT40 Shank | Diameter Range: 2.00" - 5.62" (50.8mm - 142.8mm)

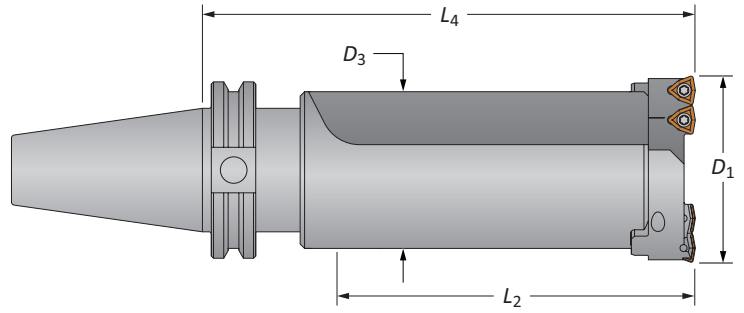

Holder

Length	D ₁ Range	D ₃	Holder		Part No.	Cartridges
			L ₂	L ₄		
Short	2.00 - 2.50	1.840	3-9/32	5-27/64	OP1-1S-CV40	OP1-WC05
Long	2.00 - 2.50	1.840	5-17/32	7-43/64	OP1-1L-CV40	OP1-WC05
Short	2.50 - 3.00	2.220	4-43/64	6-7/8	OP2-1S-CV40	OP2-WC05
Long	2.50 - 3.00	2.220	7-43/64	9-7/8	OP2-1L-CV40	OP2-WC05
Short	3.00 - 4.12	2.806	5-7/64	7-3/8	OP3-1S-CV40	OP3-WC05
Long	3.00 - 4.12	2.806	9-7/64	11-3/8	OP3-1L-CV40	OP3-WC05
Short	4.12 - 5.62	3.500	5-1/64	7-3/8	OP4-1S-CV40	OP4-WC05

Cartridges

Replacement Cartridges	Qty. Inserts Needed	Mounting Screw	Adjusting Screw
OP1-WC05	2	MS-13M-1	AS-10T9-1
OP2-WC05	2	MS-15M-1	AS-10T9-1
OP3-WC05	2	MS-15M-1	AS-12T9-1
OP4-WC05	3	MS-15M-1	AS-14T9-1

IC Inserts

Carbide Grade	Geometry	Part No.			Insert Screws
		AM300®	AM200®	TiN	
C5 (P35)	Standard	OP-05T308-P	OP-05T308-H	OP-05T308-T	IS-10-1
C1 (K35)	Standard	OP-05T308-1P	OP-05T308-1H	OP-05T308-1T	IS-10-1
C2 (K25)	Standard	OP-05T308-2P	OP-05T308-2H	-	IS-10-1
C5 (P35)	High Rake	OP-05T308-PHR	OP-05T308-HHR	-	IS-10-1

A70: 14 - 17

A70: 2 - 3

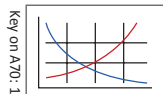

Mounting screws sold in multiples of 4 | Adjusting screws sold in multiples of 4
 IC inserts sold in multiples of 10 | Insert screws sold in multiples of 10

i = Imperial (in)
m = Metric (mm)

A DRILLING
 B BORING
 C REAMING
 D BURNISHING
 E THREADING
 X SPECIALS

Opening Drill Holders

CAT50 Shank | Diameter Range: 2.00" - 5.62" (50.8mm - 142.8mm)

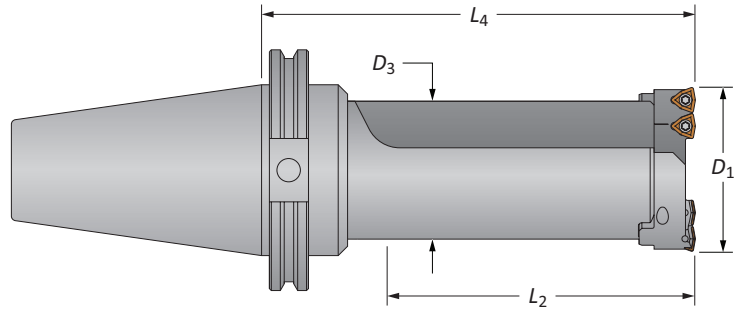

Holder

Length	D ₁ Range	Holder			Part No.	Cartridges
		D ₃	L ₂	L ₄		
Short	2.00 - 2.50	1.840	3-9/32	5-27/64	OP1-1S-CV50	OP1-WC05
			5-17/32	7-43/64	OP1-1L-CV50	OP1-WC05
Long	2.50 - 3.00	2.220	4-43/64	6-7/8	OP2-1S-CV50	OP2-WC05
			7-43/64	9-7/8	OP2-1L-CV50	OP2-WC05
Short	3.00 - 4.12	2.806	5-7/64	7-3/8	OP3-1S-CV50	OP3-WC05
			9-7/64	11-3/8	OP3-1L-CV50	OP3-WC05
Long	4.12 - 5.62	3.500	5-1/64	7-3/8	OP4-1S-CV50	OP4-WC05
			10-33/64	12-7/8	OP4-1L-CV50	OP4-WC05

Cartridges

Replacement Cartridges	Qty. Inserts Needed	Mounting Screw	Adjusting Screw
OP1-WC05	2	MS-13M-1	AS-10T9-1
OP2-WC05	2	MS-15M-1	AS-10T9-1
OP3-WC05	2	MS-15M-1	AS-12T9-1
OP4-WC05	3	MS-15M-1	AS-14T9-1

IC Inserts

Carbide Grade	Geometry	Part No.			Insert Screws
		AM300®	AM200®	TiN	
C5 (P35)	Standard	OP-05T308-P	OP-05T308-H	OP-05T308-T	IS-10-1
C1 (K35)	Standard	OP-05T308-1P	OP-05T308-1H	OP-05T308-1T	IS-10-1
C2 (K25)	Standard	OP-05T308-2P	OP-05T308-2H	-	IS-10-1
C5 (P35)	High Rake	OP-05T308-PHR	OP-05T308-HHR	-	IS-10-1

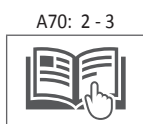
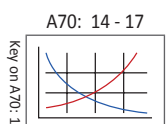

Mounting screws sold in multiples of 4 | Adjusting screws sold in multiples of 4
 IC inserts sold in multiples of 10 | Insert screws sold in multiples of 10

i = Imperial (in)
m = Metric (mm)

Opening Drill Holders

BT40 Shank | Diameter Range: 2.00" - 5.62" (50.8mm - 142.8mm)

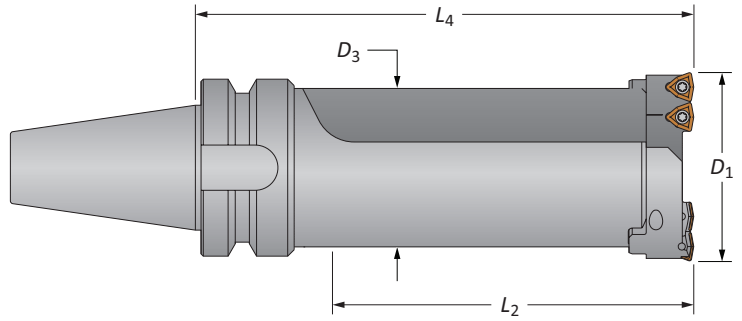

Holder

Length	D ₁ Range	D ₃	Holder		Part No.	Cartridges
			L ₂	L ₄		
Short	50.8 - 63.5	1.840	83.5	137.8	OP1-1S-BT40	OP1-WC05
			140.6	195.0	OP1-1L-BT40	OP1-WC05
Long	50.8 - 63.5	1.840	118.5	174.7	OP2-1S-BT40	OP2-WC05
			194.7	250.9	OP2-1L-BT40	OP2-WC05
Short	63.5 - 76.2	2.220	129.9	187.4	OP3-1S-BT40	OP3-WC05
			231.5	289.0	OP3-1L-BT40	OP3-WC05
Long	63.5 - 76.2	2.220	127.4	187.4	OP4-1S-BT40	OP4-WC05

Cartridges

Replacement Cartridges	Qty. Inserts Needed	Mounting Screw	Adjusting Screw
OP1-WC05	2	MS-13M-1	AS-10T9-1
OP2-WC05	2	MS-15M-1	AS-10T9-1
OP3-WC05	2	MS-15M-1	AS-12T9-1
OP4-WC05	3	MS-15M-1	AS-14T9-1

IC Inserts

Carbide Grade	Geometry	Part No.			Insert Screws
		AM300®	AM200®	TiN	
C5 (P35)	Standard	OP-05T308-P	OP-05T308-H	OP-05T308-T	IS-10-1
C1 (K35)	Standard	OP-05T308-1P	OP-05T308-1H	OP-05T308-1T	IS-10-1
C2 (K25)	Standard	OP-05T308-2P	OP-05T308-2H	-	IS-10-1
C5 (P35)	High Rake	OP-05T308-PHR	OP-05T308-HHR	-	IS-10-1

A70: 14 - 17

A70: 2 - 3

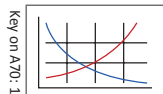

Mounting screws sold in multiples of 4 | Adjusting screws sold in multiples of 4
 IC inserts sold in multiples of 10 | Insert screws sold in multiples of 10

i = Imperial (in)
m = Metric (mm)

A DRILLING
 B BORING
 C REAMING
 D BURNISHING
 E THREADING
 X SPECIALS

Opening Drill Holders

BT50 Shank | Diameter Range: 2.00" - 5.62" (50.8mm - 142.8mm)

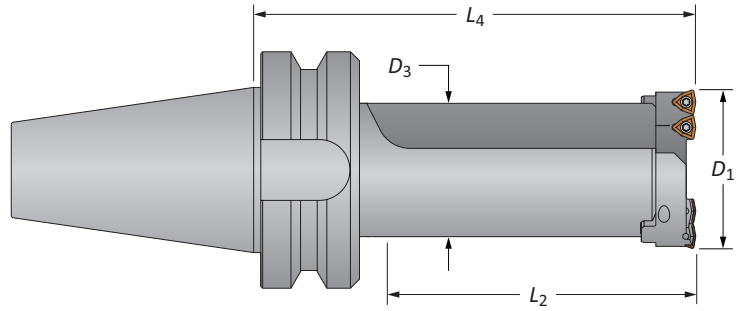

Holder

Length	D ₁ Range	D ₃	Holder		Part No.	Cartridges	
			L ₂	L ₄			
m	Short	50.8 - 63.5	1.840	83.5	147.4	OP1-1S-BT50	OP1-WC05
	Long	50.8 - 63.5	1.840	140.6	204.5	OP1-1L-BT50	OP1-WC05
	Short	63.5 - 76.2	2.220	118.5	174.7	OP2-1S-BT50	OP2-WC05
	Long	63.5 - 76.2	2.220	194.7	260.4	OP2-1L-BT50	OP2-WC05
	Short	76.2 - 104.7	2.806	129.9	196.9	OP3-1S-BT50	OP3-WC05
	Long	76.2 - 104.7	2.806	231.5	298.5	OP3-1L-BT50	OP3-WC05
	Short	104.7 - 142.8	3.500	127.4	196.9	OP4-1S-BT50	OP4-WC05
	Long	104.7 - 142.8	3.500	254.4	336.5	OP4-1L-BT50	OP4-WC05

Cartridges

Replacement Cartridges	Qty. Inserts Needed	Mounting Screw	Adjusting Screw
OP1-WC05	2	MS-13M-1	AS-10T9-1
OP2-WC05	2	MS-15M-1	AS-10T9-1
OP3-WC05	2	MS-15M-1	AS-12T9-1
OP4-WC05	3	MS-15M-1	AS-14T9-1

IC Inserts

Carbide Grade	Geometry	Part No.			Insert Screws
		AM300®	AM200®	TiN	
C5 (P35)	Standard	OP-05T308-P	OP-05T308-H	OP-05T308-T	IS-10-1
C1 (K35)	Standard	OP-05T308-1P	OP-05T308-1H	OP-05T308-1T	IS-10-1
C2 (K25)	Standard	OP-05T308-2P	OP-05T308-2H	-	IS-10-1
C5 (P35)	High Rake	OP-05T308-PHR	OP-05T308-HHR	-	IS-10-1

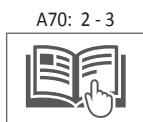
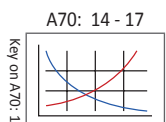

Mounting screws sold in multiples of 4 | Adjusting screws sold in multiples of 4
 IC inserts sold in multiples of 10 | Insert screws sold in multiples of 10

i = Imperial (in)
m = Metric (mm)

Opening Drill Holders

HSK63 Shank | Diameter Range: 2.00" - 5.62" (50.8mm - 142.8mm)

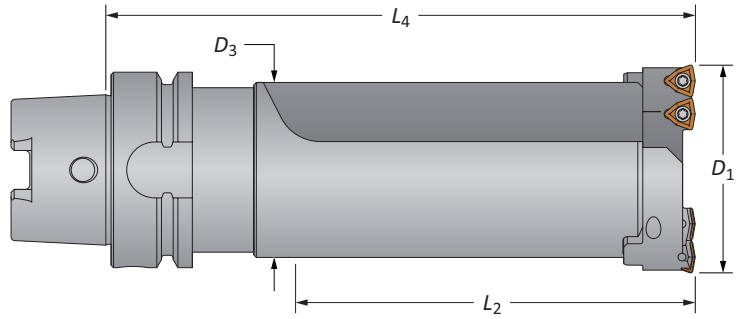

Holder

Length	D ₁ Range	D ₃	Holder		Part No.	Cartridges
			L ₂	L ₄		
Short	2.00 - 2.50	1.840	3-9/32	5-59/64	OP1-1S-HSK63	OP1-WC05
			5-17/32	8-11/64	OP1-1L-HSK63	OP1-WC05
Long	2.00 - 2.50	1.840	4-43/64	7-3/8	OP2-1S-HSK63	OP2-WC05
			7-43/64	10-3/8	OP2-1L-HSK63	OP2-WC05
Short	2.50 - 3.00	2.220	5-7/64	7-7/8	OP3-1S-HSK63	OP3-WC05
			9-7/64	11-7/8	OP3-1L-HSK63	OP3-WC05
Long	2.50 - 3.00	2.220	5-7/64	7-7/8	OP3-1S-HSK63	OP3-WC05
			9-7/64	11-7/8	OP3-1L-HSK63	OP3-WC05
Short	3.00 - 4.12	2.806	5-1/64	7-7/8	OP4-1S-HSK63	OP4-WC05
			5-1/64	7-7/8	OP4-1S-HSK63	OP4-WC05

Cartridges

Replacement Cartridges	Qty. Inserts Needed	Mounting Screw	Adjusting Screw
OP1-WC05	2	MS-13M-1	AS-10T9-1
OP2-WC05	2	MS-15M-1	AS-10T9-1
OP3-WC05	2	MS-15M-1	AS-12T9-1
OP4-WC05	3	MS-15M-1	AS-14T9-1

IC Inserts

Carbide Grade	Geometry	Part No.			Insert Screws
		AM300®	AM200®	TiN	
C5 (P35)	Standard	OP-05T308-P	OP-05T308-H	OP-05T308-T	IS-10-1
C1 (K35)	Standard	OP-05T308-1P	OP-05T308-1H	OP-05T308-1T	IS-10-1
C2 (K25)	Standard	OP-05T308-2P	OP-05T308-2H	-	IS-10-1
C5 (P35)	High Rake	OP-05T308-PHR	OP-05T308-HHR	-	IS-10-1

A70: 14 - 17

A70: 2 - 3

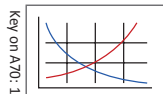

Mounting screws sold in multiples of 4 | Adjusting screws sold in multiples of 4
 IC inserts sold in multiples of 10 | Insert screws sold in multiples of 10

i = Imperial (in)
m = Metric (mm)

A DRILLING
 B BORING
 C REAMING
 D BURNISHING
 E THREADING
 X SPECIALS

Opening Drill Holders

HSK100 Shank | Diameter Range: 2.00" - 5.62" (50.8mm - 142.8mm)

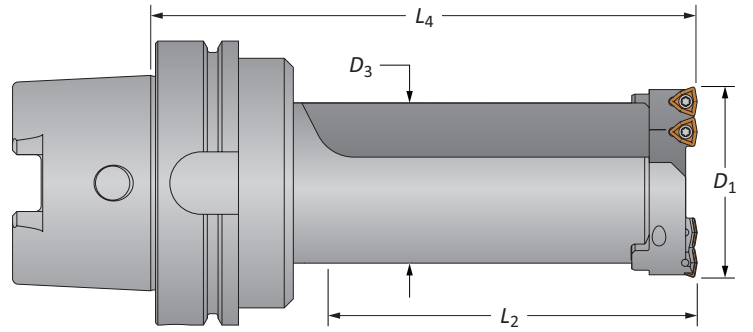

Holder

Length	D ₁ Range	D ₃	Holder		Part No.	Cartridges
			L ₂	L ₄		
Short	2.00 - 2.50	1.840	3-9/32	6-1/64	OP1-1S-HSK100	OP1-WC05
			5-17/32	8-17/64	OP1-1L-HSK100	OP1-WC05
Long	2.50 - 3.00	2.220	4-43/64	7-15/32	OP2-1S-HSK100	OP2-WC05
			7-43/64	10-15/32	OP2-1L-HSK100	OP2-WC05
Short	3.00 - 4.12	2.806	5-7/64	7-31/32	OP3-1S-HSK100	OP3-WC05
			9-7/64	11-31/32	OP3-1L-HSK100	OP3-WC05
Long	4.12 - 5.62	3.500	5-1/64	7-31/32	OP4-1S-HSK100	OP4-WC05
			10-33/64	13-15/32	OP4-1L-HSK100	OP4-WC05

Cartridges

Replacement Cartridges	Qty. Inserts Needed	Mounting Screw	Adjusting Screw
OP1-WC05	2	MS-13M-1	AS-10T9-1
OP2-WC05	2	MS-15M-1	AS-10T9-1
OP3-WC05	2	MS-15M-1	AS-12T9-1
OP4-WC05	3	MS-15M-1	AS-14T9-1

IC Inserts

Carbide Grade	Geometry	Part No.			Insert Screws
		AM300®	AM200®	TiN	
C5 (P35)	Standard	OP-05T308-P	OP-05T308-H	OP-05T308-T	IS-10-1
C1 (K35)	Standard	OP-05T308-1P	OP-05T308-1H	OP-05T308-1T	IS-10-1
C2 (K25)	Standard	OP-05T308-2P	OP-05T308-2H	-	IS-10-1
C5 (P35)	High Rake	OP-05T308-PHR	OP-05T308-HHR	-	IS-10-1

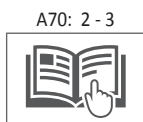
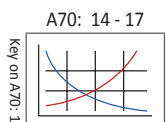

Mounting screws sold in multiples of 4 | Adjusting screws sold in multiples of 4
 IC inserts sold in multiples of 10 | Insert screws sold in multiples of 10

i = Imperial (in)
m = Metric (mm)

Opening Drill Holders

ABS63 Shank | Diameter Range: 2.00" - 5.62" (50.8mm - 142.8mm)

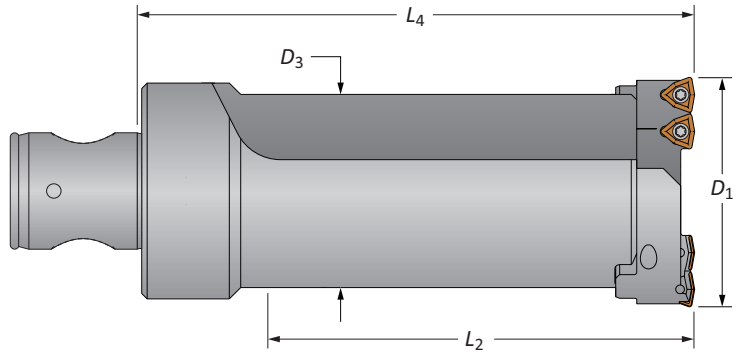

Holder

Length	D ₁ Range	D ₃	Holder		Part No.	Cartridges
			L ₂	L ₄		
Short	2.00 - 2.50	1.840	3-9/32	5-1/2	OP1-1S-ABS63	OP1-WC05
Long	2.00 - 2.50	1.840	5-17/32	7-3/4	OP1-1L-ABS63	OP1-WC05
Short	2.50 - 3.00	2.220	4-43/64	6-1/4	OP2-1S-ABS63	OP2-WC05
Long	2.50 - 3.00	2.220	7-43/64	9-1/4	OP2-1L-ABS63	OP2-WC05
Short	3.00 - 4.12	2.806	5-7/64	6-3/4	OP3-1S-ABS63	OP3-WC05
Long	3.00 - 4.12	2.806	9-7/64	10-3/4	OP3-1L-ABS63	OP3-WC05
Short	4.12 - 5.62	3.500	5-1/64	6-3/4	OP4-1S-ABS63	OP4-WC05

Cartridges

Replacement Cartridges	Qty. Inserts Needed	Mounting Screw	Adjusting Screw
OP1-WC05	2	MS-13M-1	AS-10T9-1
OP2-WC05	2	MS-15M-1	AS-10T9-1
OP3-WC05	2	MS-15M-1	AS-12T9-1
OP4-WC05	3	MS-15M-1	AS-14T9-1

IC Inserts

Carbide Grade	Geometry	Part No.			Insert Screws
		AM300®	AM200®	TiN	
C5 (P35)	Standard	OP-05T308-P	OP-05T308-H	OP-05T308-T	IS-10-1
C1 (K35)	Standard	OP-05T308-1P	OP-05T308-1H	OP-05T308-1T	IS-10-1
C2 (K25)	Standard	OP-05T308-2P	OP-05T308-2H	-	IS-10-1
C5 (P35)	High Rake	OP-05T308-PHR	OP-05T308-HHR	-	IS-10-1

A70: 14 - 17

A70: 2 - 3

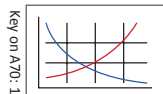

Mounting screws sold in multiples of 4 | Adjusting screws sold in multiples of 4
 IC inserts sold in multiples of 10 | Insert screws sold in multiples of 10

i = Imperial (in)
m = Metric (mm)

A DRILLING
 B BORING
 C REAMING
 D BURNISHING
 E THREADING
 X SPECIALS

Opening Drill Holders

DIN50 Shank | Diameter Range: 2.00" - 5.62" (50.8mm - 142.8mm)

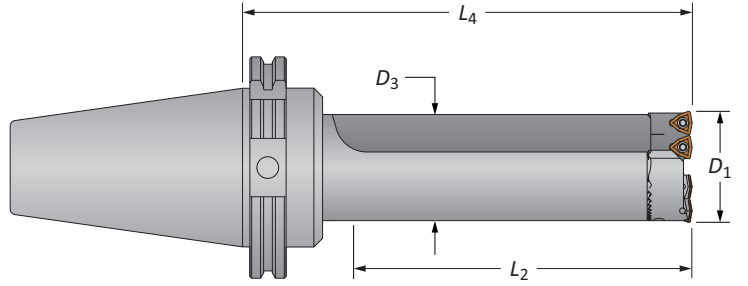

Holder

Length	D ₁ Range	D ₃	Holder		Part No.	Cartridges	
			L ₂	L ₄			
m	Short	50.8 - 63.5	1.840	83.5	137.9	OP1-1S-DV50	OP1-WC05
	Long	50.8 - 63.5	1.840	140.6	195.1	OP1-1L-DV50	OP1-WC05
	Short	63.5 - 76.2	2.220	118.5	174.8	OP2-1S-DV50	OP2-WC05
	Long	63.5 - 76.2	2.220	194.7	251.0	OP2-1L-DV50	OP2-WC05
	Short	76.2 - 104.7	2.806	129.9	187.5	OP3-1S-DV50	OP3-WC05
	Long	76.2 - 104.7	2.806	231.5	289.1	OP3-1L-DV50	OP3-WC05
	Short	104.7 - 142.8	3.500	127.4	187.5	OP4-1S-DV50	OP4-WC05
	Long	104.7 - 142.8	3.500	254.4	327.2	OP4-1L-DV50	OP4-WC05

Cartridges

Replacement Cartridges	Qty. Inserts Needed	Mounting Screw	Adjusting Screw
OP1-WC05	2	MS-13M-1	AS-10T9-1
OP2-WC05	2	MS-15M-1	AS-10T9-1
OP3-WC05	2	MS-15M-1	AS-12T9-1
OP4-WC05	3	MS-15M-1	AS-14T9-1

IC Inserts

Carbide Grade	Geometry	Part No.			Insert Screws
		AM300®	AM200®	TiN	
C5 (P35)	Standard	OP-05T308-P	OP-05T308-H	OP-05T308-T	IS-10-1
C1 (K35)	Standard	OP-05T308-1P	OP-05T308-1H	OP-05T308-1T	IS-10-1
C2 (K25)	Standard	OP-05T308-2P	OP-05T308-2H	-	IS-10-1
C5 (P35)	High Rake	OP-05T308-PHR	OP-05T308-HHR	-	IS-10-1

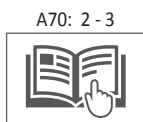
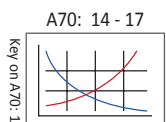

Mounting screws sold in multiples of 4 | Adjusting screws sold in multiples of 4
 IC inserts sold in multiples of 10 | Insert screws sold in multiples of 10

 = Imperial (in)
 = Metric (mm)

Recommended Cutting Data | Imperial (inch)

ISO	Material	Hardness (BHN)	Speed (SFM)			Feed Rate (IPR)
			AM300®	AM200®	TiN	
P	Free Machining Steel 1118, 1215, 12L14, etc.	100 - 250	900 - 1300	850 - 1200	700 - 900	.0035 - .007
	Low Carbon Steel 1010, 1020, 1025, 1522, 1144, etc.	85 - 275	850 - 1250	800 - 1150	650 - 850	.003 - .0065
	Medium Carbon Steel 1030, 1040, 1050, 1527, 1140, 1151, etc.	125 - 325	800 - 1050	750 - 950	600 - 850	.0035 - .0065
	Alloy Steel 4140, 5140, 8640, etc.	125 - 375	750 - 1000	700 - 900	600 - 850	.0035 - .0065
	High Strength Alloy 4340, 4330V, 300M, etc.	225 - 400	600 - 850	550 - 750	400 - 650	.003 - .005
	Structural Steel A36, A285, A516, etc.	100 - 350	850 - 1050	800 - 950	650 - 850	.003 - .0065
	Tool Steel H-13, H-21, A-4, O-2, S-3, etc.	150 - 250	400 - 800	350 - 700	250 - 650	.0025 - .005
	S	High Temp Alloy Hastelloy B, Inconel 600, etc.	140 - 310	250 - 450	250 - 350	150 - 300
M	Stainless Steel 400 Series 416, 420, etc.	185 - 350	600 - 850	550 - 750	400 - 650	.003 - .006
	Stainless Steel 300 Series 304, 316, 17-4PH, etc.	135 - 275	600 - 850	550 - 750	400 - 650	.003 - .006
	Super Duplex Stainless Steel	135 - 275	500 - 750	450 - 650	300 - 550	.002 - .005
K	Nodular, Grey, Ductile Cast Iron	120 - 320	700 - 900	650 - 800	500 - 700	.004 - .008
N	Cast Aluminum	30 - 180	1250 - 1650	1200 - 1550	950 - 1100	.006 - .012
	Wrought Aluminum	30 - 180	1250 - 1650	1200 - 1550	950 - 1100	.006 - .012
	Brass	30 - 100	950 - 1350	900 - 1250	750 - 1100	.005 - .009

Minimum Pilot Hole Diameter = Finish Diameter - C

Ex: To open an existing diameter hole to 2.75" diameter, an OP2 tool would be used. The minimum pilot hole diameter would be: **2.750 - 1.880 = 0.870"**

Opening Drill Series	Drill Diameter Range	C
OP1	2.00 - 2.50	1.880
OP2	2.50 - 3.00	1.880
OP3	3.00 - 4.12	1.880
OP4	4.12 - 5.62	2.680

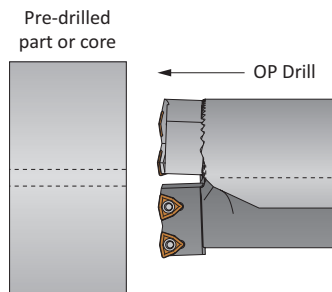

IMPORTANT: The speeds and feeds listed above are considered a general starting point for all applications. Factory technical assistance is available for your specific applications through our Application Engineering department.

Formulas and Constants | Imperial (inch)

Material Constants



Type of Material	Hardness (BHN)	K _m (lbs/in ²)
Free Machining Steel	100 - 250	0.75
Low Carbon Steel	85 - 275	0.85
Medium Carbon Steel	125 - 325	0.90
Alloy Steel	125 - 375	1.00
High Strength Steel	225 - 400	1.15
Structural Steel	100 - 350	1.00
Tool Steel	150 - 250	0.90
High Temperature Alloy	140 - 310	1.44
Titanium Alloy	140 - 310	0.72
Aerospace Alloy	185 - 350	0.70
Stainless Steel 400 Series	185 - 350	1.08
Stainless Steel 300 Series	135 - 275	0.94
Super Duplex Stainless Steel	135 - 275	0.94
Wear Plate	400 - 600	1.60
Hardened Steel	300 - 500	1.40
Nodular, Ductile Cast Iron	120 - 320	0.65
Grey Cast Iron	120 - 320	0.75
Cast Aluminum	30 - 180	0.40
Wrought Aluminum	30 - 180	0.40
Aluminum Bronze	100 - 250	0.50
Brass	100	0.35
Copper	60	0.30

Formulas

1. RPM	$= (3.82 \cdot \text{SFM}) / \text{DIA}_F$
<i>where:</i>	
RPM	= revolutions per minute (rev/min)
SFM	= speed (ft/min)
DIA _F	= finish diameter of drill (inch)
2. HP	$= (0.5891 \cdot (\text{DIA}_F^2 - \text{DIA}_P^2) \cdot \text{IPR} \cdot \text{RPM} \cdot \text{K}_m) / 0.80$
<i>where:</i>	
Tool Power	= tool power (HP)
DIA _F	= finish diameter of drill (inch)
DIA _P	= pre-drill diameter (inch)
IPR	= feed rate (in/rev)
RPM	= revolutions per minute (rev/min)
K _m	= specific cutting energy (lbs/in ²) machine efficiency (using 0.80 as constant)
3. Thrust	$= 148,500 \cdot \text{IPR} \cdot (\text{DIA}_F - \text{DIA}_P) \cdot \text{K}_m$
<i>where:</i>	
Thrust	= axial thrust (lbs)
IPR	= feed rate (in/rev)
DIA _F	= finish diameter of drill (inch)
DIA _P	= pre-drill diameter (inch)
K _m	= specific cutting energy (lbs/in ²)
5. Torque	$= (\text{HP} \cdot 5252) / \text{RPM}$
<i>where:</i>	
Torque	= torque (ft/lbs)
HP	= tool power (HP)
RPM	= revolutions per minute (rev/min)

The table and equations on this page are found in the *Machinery's Handbook*. Permission to simplify and print the equations is granted by the Editor of the *Machinery's Handbook*.

Recommended Cutting Data | Metric (mm)

ISO	Material	Hardness (BHN)	Speed (M/min)			Feed Rate (mm/rev)
			 AM300®	 AM200®	 TiN	
P	Free Machining Steel 1118, 1215, 12L14, etc.	100 - 250	274 - 396	259 - 366	213 - 274	0.09 - 0.18
	Low Carbon Steel 1010, 1020, 1025, 1522, 1144, etc.	85 - 275	259 - 381	244 - 351	198 - 259	0.08 - 0.17
	Medium Carbon Steel 1030, 1040, 1050, 1527, 1140, 1151, etc.	125 - 325	244 - 320	229 - 290	183 - 259	0.09 - 0.17
	Alloy Steel 4140, 5140, 8640, etc.	125 - 375	229 - 305	213 - 274	183 - 259	0.09 - 0.17
	High Strength Alloy 4340, 4330V, 300M, etc.	225 - 400	183 - 259	168 - 229	122 - 198	0.08 - 0.13
	Structural Steel A36, A285, A516, etc.	100 - 350	259 - 320	244 - 290	198 - 259	0.08 - 0.17
	Tool Steel H-13, H-21, A-4, O-2, S-3, etc.	150 - 250	122 - 244	107 - 213	76 - 198	0.06 - 0.13
S	High Temp Alloy Hastelloy B, Inconel 600, etc.	140 - 310	76 - 137	76 - 107	46 - 91	0.06 - 0.11
M	Stainless Steel 400 Series 416, 420, etc.	185 - 350	183 - 259	168 - 229	122 - 198	0.08 - 0.15
	Stainless Steel 300 Series 304, 316, 17-4PH, etc.	135 - 275	183 - 259	168 - 229	122 - 198	0.08 - 0.15
	Super Duplex Stainless Steel	135 - 275	152 - 228	137 - 198	91 - 152	0.05 - 0.12
K	Nodular, Grey, Ductile Cast Iron	120 - 320	213 - 274	198 - 244	152 - 213	0.10 - 0.20
N	Cast Aluminum	30 - 180	381 - 503	381 - 472	290 - 335	0.15 - 0.30
	Wrought Aluminum	30 - 180	381 - 503	381 - 472	290 - 335	0.15 - 0.30
	Brass	30 - 100	290 - 411	274 - 381	229 - 335	0.13 - 0.23

Minimum Pilot Hole Diameter = Finish Diameter – C

Ex: To open an existing diameter hole to 69.85mm diameter, an OP2 tool would be used. The minimum pilot hole diameter would be: **69.85 - 47.75 = 22.10**

Opening Drill Series	Drill Diameter Range	C
OP1	50.8 - 63.5	47.75
OP2	63.5 - 76.2	47.75
OP3	76.2 - 104.6	47.75
OP4	104.6 - 142.7	68.07

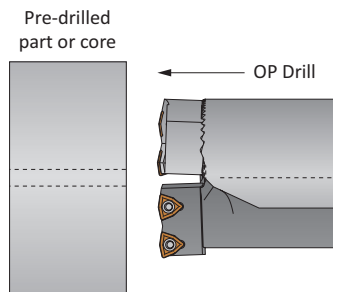

IMPORTANT: The speeds and feeds listed above are considered a general starting point for all applications. Factory technical assistance is available for your specific applications through our Application Engineering department.

Formulas and Constants | Metric (mm)

Material Constants

Type of Material	Hardness (BHN)	K _m (lbs/in ²)
Free Machining Steel	100 - 250	5.17
Low Carbon Steel	85 - 275	5.86
Medium Carbon Steel	125 - 325	6.21
Alloy Steel	125 - 375	6.90
High Strength Steel	225 - 400	7.93
Structural Steel	100 - 350	6.90
Tool Steel	150 - 250	6.21
High Temperature Alloy	140 - 310	9.93
Titanium Alloy	140 - 310	4.97
Aerospace Alloy	185 - 350	4.48
Stainless Steel 400 Series	185 - 350	7.45
Stainless Steel 300 Series	135 - 275	6.48
Super Duplex Stainless Steel	135 - 275	6.48
Wear Plate	400 - 600	11.04
Hardened Steel	300 - 500	9.66
Nodular, Ductile Cast Iron	120 - 320	4.48
Grey Cast Iron	120 - 320	5.17
Cast Aluminum	30 - 180	2.76
Wrought Aluminum	30 - 180	2.76
Aluminum Bronze	100 - 250	3.45
Brass	100	2.41
Copper	60	2.07

Formulas

1. RPM	= (318.31 • M/min) / DIA_F
<i>where:</i>	
RPM	= revolutions per minute (rev/min)
M/min	= speed (M/min)
DIA _F	= finish diameter of drill (mm)
2. kW	= ((DIA_F² - DIA_P²) • mm/rev • RPM • K_m) / 205,154
<i>where:</i>	
kW	= tool power (kW)
DIA _F	= finish diameter of drill (mm)
DIA _P	= pre-drill diameter (mm)
mm/rev	= feed rate (mm/rev)
RPM	= revolutions per minute (rev/min)
K _m	= specific cutting energy (kPa) machine efficiency (using 205,154 as constant)
3. Thrust	= 148.78 • mm/rev • (DIA_F - DIA_P) • K_m
<i>where:</i>	
Thrust	= axial thrust (N)
IPR	= feed rate (mm/rev)
DIA _F	= finish diameter of drill (mm)
DIA _P	= predrill diameter (mm)
K _m	= specific cutting energy (kPa)
4. Torque	= (kW • 9549.3) / RPM
<i>where:</i>	
Torque	= torque (Nm)
kW	= tool power (kW)
RPM	= revolutions per minute (rev/min)

The table and equations on this page are found in the *Machinery's Handbook*. Permission to simplify and print the equations is granted by the Editor of the *Machinery's Handbook*.

Structural Steel Drilling Solutions

Replaceable Insert Drilling System | GEN3SYS® XT | Original T-A® and GEN2 T-A®

- ▶ GEN3SYS XT Diameter Range: 0.4331" - 1.3780" (11.00mm - 35.00mm)
- ▶ T-A Diameter Range: 0.511" - 1.882" (12.98mm - 47.80mm)



Take on Tough Drilling

Allied Machine's Structural Steel Drilling System is designed for maximum performance in structural steel materials and applications. These solutions utilize the GEN3SYS XT, Original T-A, and GEN2 T-A designs and capabilities.

With multiple geometries and coatings, you're sure to find the solution that is right for you. Tough drilling is tough no more.

Excellent chip control	Improves hole quality and surface finish	Provides maximum durability and stability
------------------------	--	---

Your safety and the safety of others is very important. This catalog contains important safety messages. Always read and follow all safety precautions.



This triangle is a safety hazard symbol. It alerts you to potential safety hazards that can cause tool failure and serious injury.

When you see this symbol in the catalog, look for a related safety message that may be near this triangle or referred to in the nearby text.

There are safety signal words also used in the catalog. Safety messages follow these words.

WARNING

WARNING (shown above) means that failure to follow the precautions in this message could result in tool failure and serious injury.

NOTICE means that failure to follow the precautions in this message could result in damage to the tool or machine but not result in personal injury.

NOTE and **IMPORTANT** are also used. These are important that you read and follow but are not safety-related.

Visit www.alliedmachine.com for the most up-to-date information and procedures.

Applicable Industries



Structural Steel

Structural Steel Drilling Solutions Contents

Introduction Information

- Structural Steel Drilling Overview 2
- Case Study Example 3
- GEN3SYS® XT System Overview 4
- T-A® System Overview 5
- Product Nomenclature 6 - 7

GEN3SYS® XT Drill Series

- 12 - 14 Series 8 - 9
- 15 - 16 Series 10 - 11
- 17 - 18 Series 12 - 13
- 20 - 22 Series 14 - 15
- 24 - 26 Series 16 - 17
- 29 - 32 Series 18 - 19

T-A® Drill Series

- 0 Series 20 - 23
- 1 Series 24 - 27
- 2 Series 28 - 31
- 3 Series 32 - 34
- Deep Hole Drilling Guidelines 35

Recommended Cutting Data

- GEN3SYS XT System 36 - 37
- T-A System 38 - 39

Reference Icons
The following icons will appear throughout the catalog to help you navigate between products.

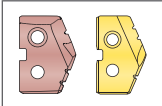

Corresponding T-A Inserts
Refers to the corresponding T-A insert items that connect with each specific holder series



Corresponding T-A Holders
Refers to the corresponding T-A holder items that connect with each specific insert series



Setup / Assembly Information
Detailed instructions and information regarding the corresponding part(s)

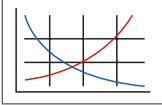

Recommended Cutting Data
Speed and feed recommendations for optimum and safe drilling

Series	GEN3SYS XT Diameter Range	
	Imperial (inch)	Metric (mm)
12	0.4724 - 0.5117	12.00 - 12.99
14	0.5512 - 0.5905	14.00 - 14.99
15	0.5906 - 0.6298	15.00 - 15.99
16	0.6299 - 0.6692	16.00 - 16.99
17	0.6693 - 0.7086	17.00 - 17.99
18	0.7087 - 0.7873	18.00 - 19.99
20	0.7874 - 0.8660	20.00 - 21.99
22	0.8661 - 0.9448	22.00 - 23.99
24	0.9449 - 1.0235	24.00 - 25.99
26	1.0236 - 1.1416	26.00 - 28.99
29	1.1417 - 1.2597	29.00 - 31.99
32	1.2598 - 1.3780	32.00 - 35.00

Series	T-A Diameter Range	
	Imperial (inch)	Metric (mm)
0	0.511 - 0.695	12.98 - 17.65
1	0.690 - 0.960	17.53 - 24.38
2	0.961 - 1.380	24.41 - 35.05
3	1.353 - 1.882	34.36 - 47.80





Structural Steel Drilling

Achieving Optimal Results in Structural Steel

Drilling in structural steel materials can be a difficult process, and achieving optimal results becomes a major issue. Allied Machine's structural steel drilling solutions have been specifically designed to produce the best results in the toughest materials. With solutions in both the T-A® and GEN3SYS® XT product lines, you have multiple options to solve your application problems.

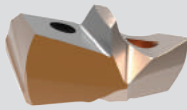
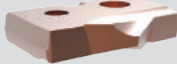

Insert Style Comparison

	 GEN3SYS® XT Structural Steel	 Original T-A® Thin Wall	 Original T-A® Notch Point®	 Original T-A® 150° Structural Steel	 GEN2 T-A® High Efficiency
Material less than 7/16" thick		<input checked="" type="checkbox"/>			
Material over 7/16" thick	<input checked="" type="checkbox"/>		<input checked="" type="checkbox"/>	<input checked="" type="checkbox"/>	<input checked="" type="checkbox"/>
Reduced exit burr			<input checked="" type="checkbox"/>	<input checked="" type="checkbox"/>	
Includes Notch Point® geometry			<input checked="" type="checkbox"/>	<input checked="" type="checkbox"/>	<input checked="" type="checkbox"/>
Available from carbide	<input checked="" type="checkbox"/>				<input checked="" type="checkbox"/>
Stocked in common sizes for the Structural Steel industry	<input checked="" type="checkbox"/>	<input checked="" type="checkbox"/>	<input checked="" type="checkbox"/>	<input checked="" type="checkbox"/>	<input checked="" type="checkbox"/>

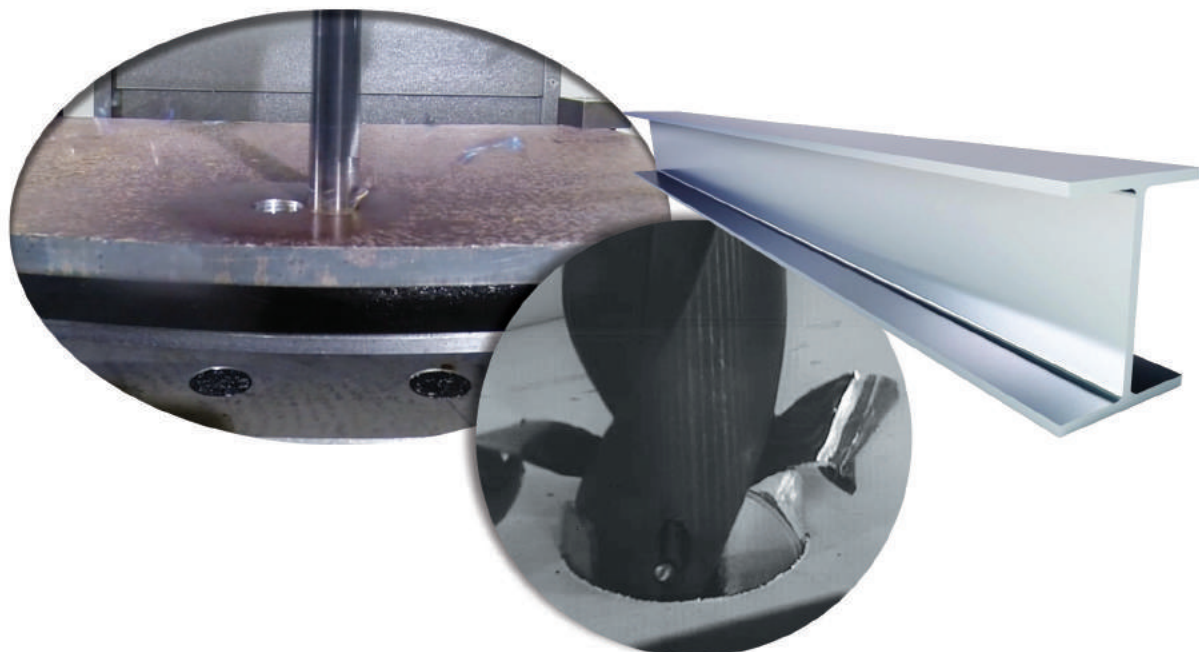

Case Study Example

CASE STUDY

Project Profile: Structural Steel I-Beam Construction
Tooling Solution: T-A® Structural Steel Drilling System

The Problem:

Previously, the customer was using a competitor spade drill running at the following parameters:

- 650 RPM
- 0.010 IPR (0.25 mm/rev)
- 6.5 IPM (165.1 mm/min)

The tool drilled a 0.875" (22.23mm) diameter hole to a 0.4375" (11.11mm) depth. The drill had a tool life of **only 20 holes**.

The poor tool performance was brought to the attention of the technician, who was familiar with Allied Machine products. The following day, Allied Machine tooling was brought in for testing. The customer needed improvement in the tool life of the inserts.

The Solution:

Allied Machine recommended the T-A Structural Steel Drilling System.

- **Insert** = 151A-0028-TW (#1 series T-A insert with TiAlN coating and Thin Wall geometry)
- **Holder** = 25010H-004IS052 (#1 series T-A holder with #4 Morse Taper shank and helical flute)

The tool ran at the following parameters:

- 440 RPM
- 0.010 IPR (0.25 mm/rev)
- 4.4 IPM (111.7 mm/min)

The tool achieved the desired diameter and depth. But most of all, the tool produced **1,500 holes**.

Summary:

The customer was able to take advantage of Allied Machine's vast experience in the structural steel drilling niche. Allied's wide variety of stocked solutions for specific customer problems allows for a remarkable increase in tool life.

The T-A Structural Steel Drilling System defeated the competition, decreasing the total cost-per-hole from \$2.02 to just \$0.22. This reduction resulted in a **savings of 89%** for the customer.

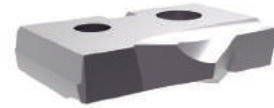

The **PROOF** is in the **NUMBERS**

Competitor Insert Tool Life
(number of holes = 20)



T-A Structural Steel Insert Tool Life
(number of holes = 1,500)

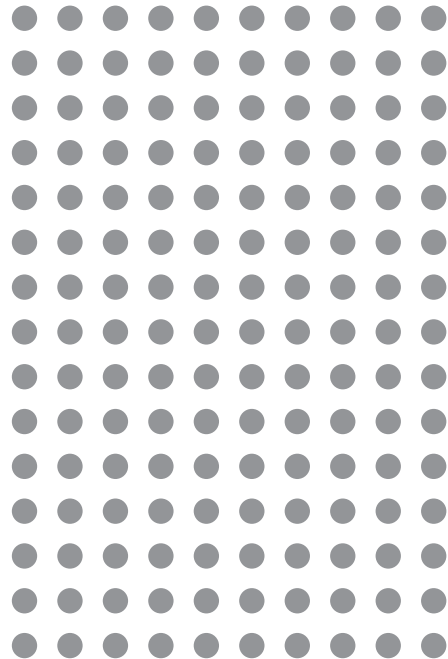

Overall **SAVINGS** of **89%**

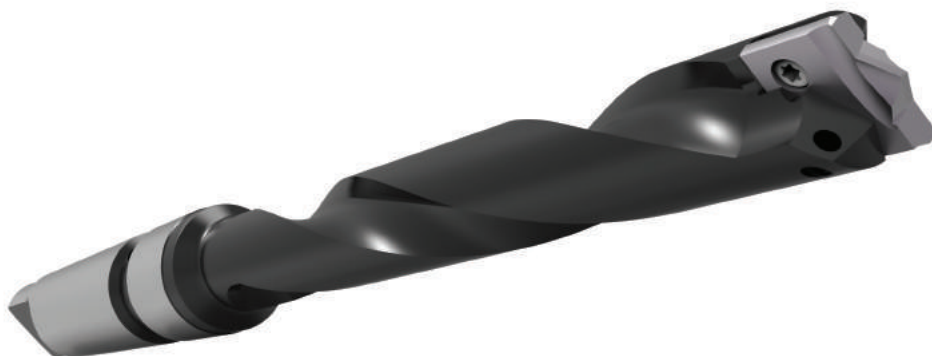

GEN3SYS® XT Structural Steel Drilling System

A
DRILLING
B
BORING
C
REAMING
D
BURNISHING
E
THREADING
X
SPECIALS

STRUCTURAL STEEL ENHANCEMENTS

GEN3SYS XT

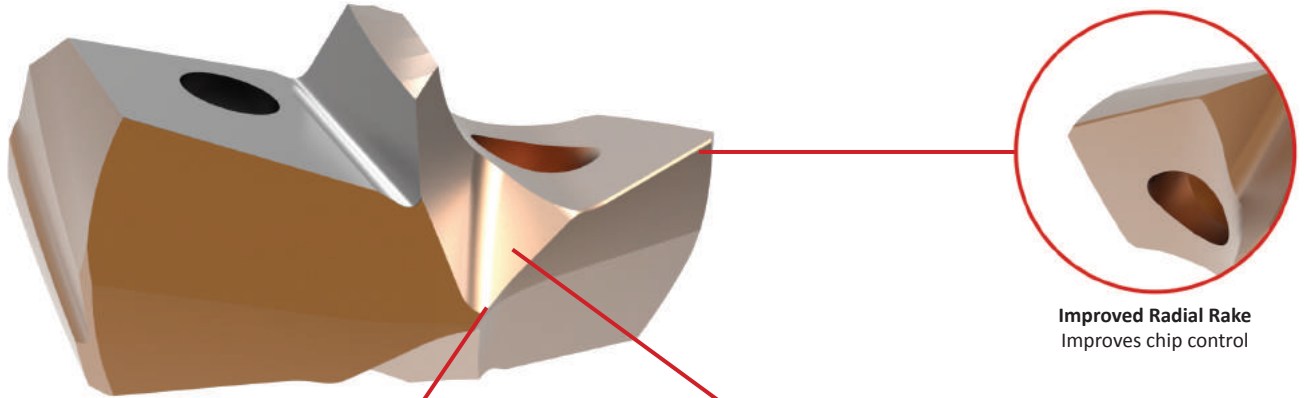

Available in AM300® Coating

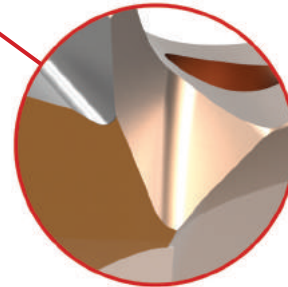
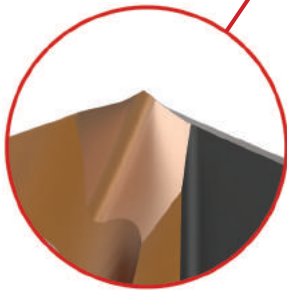

Holder Anatomy

1. Flanged Shank with Flat
2. Coolant Inlet
3. Flute (straight only)
4. Coolant Outlets



Straight Flute

NOTICE: Structural Steel GEN3SYS XT holders are specifically designed to be used only with ST geometry inserts. Using other GEN3SYS XT or XT Pro insert geometries in these holders could lead to chip packing and tool failure. Contact Application Engineering for questions regarding proper use of tools.

T-A® Structural Steel Drilling System

STRUCTURAL STEEL ENHANCEMENTS

Original T-A & GEN2 T-A

GEN2 T-A Insert

Available in AM200® Coating



High Efficiency (-HE)

- Improves performance
- Improves tool life
- Improves chip formation in structural steel materials

Original T-A Inserts

Available in AM200® and TiAlN Coatings



Thin Wall (-TW)

- Designed for drilling 7/16" thick or less I-Beam or structural materials
- Increases hole diameter tolerance
- Improves hole roundness
- Decreases material deflection



Notch Point® (-NP)

- Provides excellent self-centering characteristics
- Reduces bell mouth and tool lead-off
- Reduces axial thrust requirements

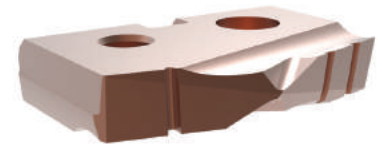

Structural Steel (-SS)

- Designed for drilling 7/16" thick or thicker I-Beam or structural materials
- Reduces exit burrs
- Increases stability
- Lowers drilling forces
- Includes Notch Point® web geometry



Holder Anatomy

1. Morse Taper Shank
2. Coolant Inlet
3. Flute (straight or helical)
4. Built-up Body Diameter
5. Coolant Outlets



Straight Flute



Helical Flute

GEN3SYS® XT Drill Nomenclature

GEN3SYS XT Drill Inserts

7	C2	14	P	-	0018	ST
1	2	3	4		5	6

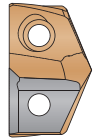

1. XT Drill Insert 7 = XT insert	2. Insert Material C2 = C2 (K20) carbide	3. Series 12 = 12 series 17 = 17 series 24 = 24 series 14 = 14 series 18 = 18 series 26 = 26 series 15 = 15 series 20 = 20 series 29 = 29 series 16 = 16 series 22 = 22 series 32 = 32 series	4. Coating P = AM300®
--	--	--	---------------------------------

5. Diameter 0102 = Inch 18 = Metric	6. Geometry ST = Structural steel
--	---

Reference Key	
Symbol	Attribute
D_1	Insert diameter

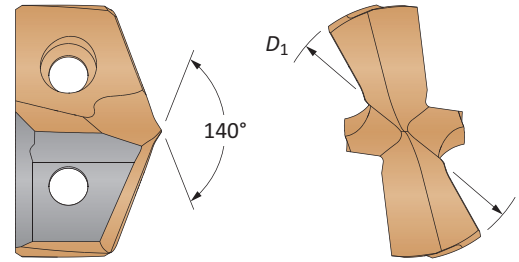

GEN3SYS XT Drill Holders

ST	03	12	0	-	20	FM
1	2	3	4		5	6

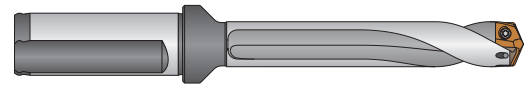

1. Holder ST = Structural steel holder	2. Length 03 = 3x Diameter 05 = 5x Diameter 07 = 7x Diameter	3. Series 12 = 12 series 17 = 17 series 24 = 24 series 14 = 14 series 18 = 18 series 26 = 26 series 15 = 15 series 20 = 20 series 29 = 29 series 16 = 16 series 22 = 22 series 32 = 32 series	4. Body Diameter 0 = Standard 5 = Oversized
--	--	--	--

5. Shank Diameter	6. Shank Style																
<table border="1"> <thead> <tr> <th colspan="2">Imperial (in)</th> <th colspan="2">Metric (mm)</th> </tr> </thead> <tbody> <tr> <td>063 = 5/8"</td> <td>125 = 1-1/4"</td> <td>16 = 16mm</td> <td>32 = 32mm</td> </tr> <tr> <td>075 = 3/4"</td> <td>150 = 1-1/2"</td> <td>20 = 20mm</td> <td>40 = 40mm</td> </tr> <tr> <td>100 = 1"</td> <td></td> <td>25 = 25mm</td> <td></td> </tr> </tbody> </table>	Imperial (in)		Metric (mm)		063 = 5/8"	125 = 1-1/4"	16 = 16mm	32 = 32mm	075 = 3/4"	150 = 1-1/2"	20 = 20mm	40 = 40mm	100 = 1"		25 = 25mm		F = Flanged with flat FM = Flanged metric with flat C = Cylindrical (no flat) CM = Cylindrical metric (no flat)
Imperial (in)		Metric (mm)															
063 = 5/8"	125 = 1-1/4"	16 = 16mm	32 = 32mm														
075 = 3/4"	150 = 1-1/2"	20 = 20mm	40 = 40mm														
100 = 1"		25 = 25mm															

Reference Key

Symbol	Attribute
D_2	Shank diameter
L_1	Overall length
L_2	Drill depth
L_3	Holder reference length
L_4	Holder body length
L_7	Shank length
P_1	Rear pipe tap

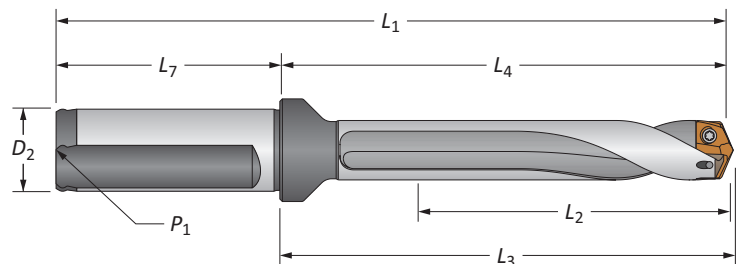

T-A® Drill Nomenclature

T-A Drill Inserts

4	5	3	H	-	0115	-	HE
1	2	3	4		5		6

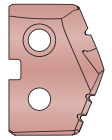

1. Insert	2. Material	3. Series	4. Coating	5. Diameter	6. Geometry
1 = Original T-A 4 = GEN2 T-A	5 = Super cobalt C1 = C1 (K35) carbide	0 = 0 series 1 = 1 series 2 = 2 series 3 = 3 series	H = AM200® A = TiAlN	0017 = Inch .515 = Decimal 13 = Metric	TW = Thin Wall NP = Notch Point® SS = Structural Steel HE = High Efficiency

Reference Key

Symbol	Attribute
D_1	Insert diameter
T_1	Insert thickness

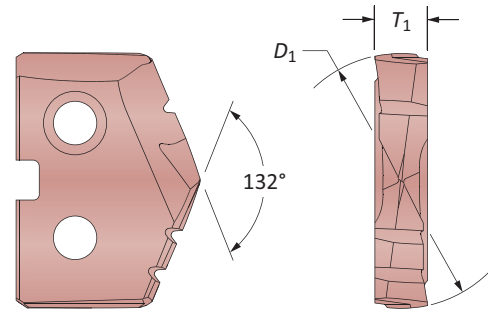

T-A Drill Holders

2	40	20	S	-	004	IS	060
1	2	3	4		5	6	7



1. Holder	2. Length	3. Series	4. Flute
2 = T-A holder	20 = Short 40 = Standard 50 = Extended 60 = Long	00 = 0 series 05 = 0.5 series 10 = 1 series 15 = 1.5 series 20 = 2 series 25 = 2.5 series 30 = 3 series	S = Straight H = Helical
5. Shank Designator	6. Shank Code	7. Minimum Insert Diameter	
003 = 3MT 004 = 4MT	IS = Imperial Morse taper structural steel	In increments of 1/64 of an inch	

Reference Key

Symbol	Attribute	Symbol	Attribute
D_1	Drill insert range	L_4	Flute length
L_1	Overall length	P_1	Rear pipe tap
L_2	Drill depth	P_2	Side pipe tap
L_3	Holder reference length	MT	Morse taper size
L_3^*	Holder reference length		

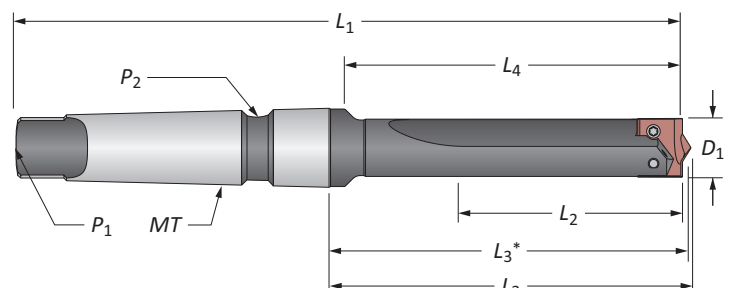

*If using Structural Steel holder with Notch Point®, GEN2 T-A, or 150° Structural Steel T-A drill insert geometry

**GEN3SYS® XT Structural Steel Drilling System**

12 Series | Diameter Range: 0.4724" - 0.5117" (12.00mm - 12.99mm)

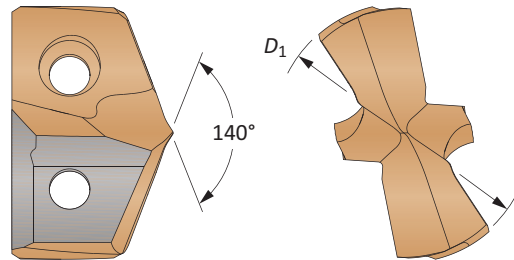
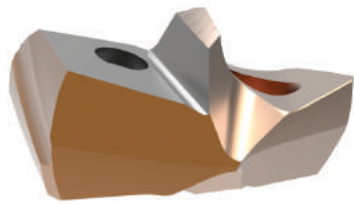
**Inserts**



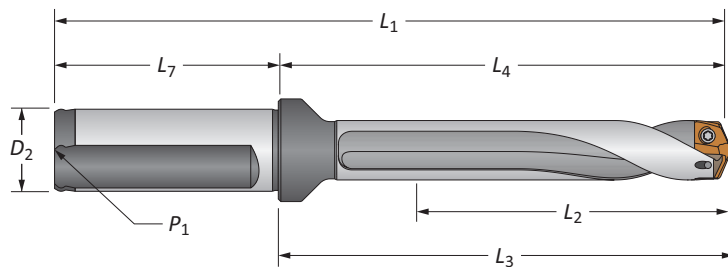

Insert				
Carbide Substrate	Fractional Equivalent	D_1 inch	D_1 mm	Structural Steel Part No.
C2 (K20)	-	0.4724	12.00	7C212P-12ST

 **HOLDERS**

Length	Body				Shank				Part No.
	L_2	L_4	L_3	L_1	L_7	D_2	P_1	Flat	
i 3xD	1-17/32	2-5/8	2-45/64	4-21/32	2-1/32	3/4	1/8	YES	ST03120-075F
i 5xD	2-9/16	3-41/64	3-47/64	5-43/64	2-1/32	3/4	1/8	YES	ST05120-075F
i 7xD	3-37/64	4-43/64	4-3/4	6-45/64	2-1/32	3/4	1/8	YES	ST07120-075F
m 3xD	39.0	68.8	68.8	118.8	50	20	1/8*	YES	ST03120-20FM
m 5xD	65.0	94.8	94.8	144.8	50	20	1/8*	YES	ST05120-20FM
m 7xD	90.9	120.8	120.8	170.8	50	20	1/8*	YES	ST07120-20FM

*Thread to BSP and ISO 7-1

Connection Accessories

					Admissible Tightening Torque*
Insert Screws	Nylon Locking Screws	Insert Driver	Preset Torque Hand Driver	Replacement Tips	
7247-IP7-1	7247N-IP7-1	8IP-7	8IP-7TL	8IP-7B	7.4 in-lbs (84 N-cm)

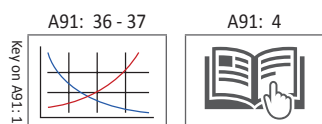
*Tightening torques are calculated with a friction coefficient of $\mu = 0.14$ and develop 90% of ultimate yield strength**i** = Imperial (in)
m = Metric (mm)

Inserts sold in multiples of 1 | Screws sold in multiples of 10

NOTICE: Structural Steel GEN3SYS XT holders are specifically designed to be used only with ST geometry inserts. Using other GEN3SYS XT or XT Pro insert geometries in these holders could lead to chip packing and tool failure. Contact Application Engineering for questions regarding proper use of tools.



GEN3SYS® XT Structural Steel Drilling System

14 Series | Diameter Range: 0.5512" - 0.5905" (14.00mm - 14.99mm)

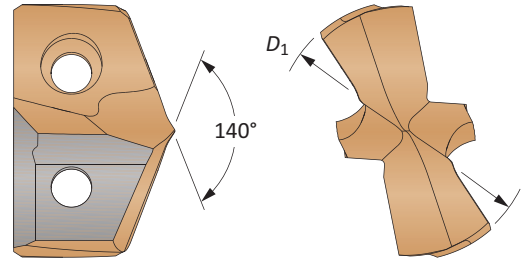
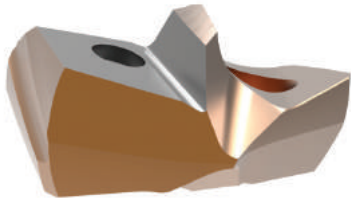

Inserts

Insert				
Carbide Substrate	Fractional Equivalent	D ₁ inch	D ₁ mm	Structural Steel Part No.
C2 (K20)	–	0.5512	14.00	7C214P-14ST
	9/16	0.5625	14.29	7C214P-0018ST

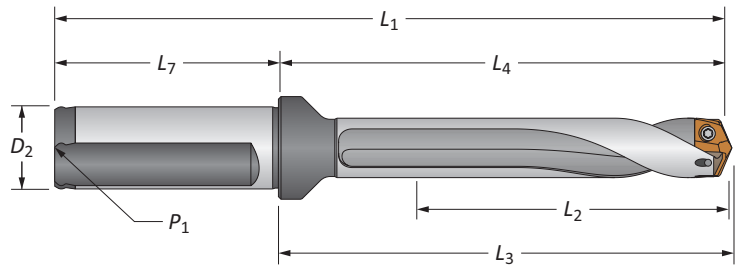





Holders

	Length	Body				Shank				Part No.
		L ₂	L ₄	L ₃	L ₁	L ₇	D ₂	P ₁	Flat	
i	3xD	1-25/32	2-27/32	2-61/64	4-7/8	2-1/32	3/4	1/8	YES	ST03140-075F
	5xD	2-61/64	4-1/32	4-1/8	6-1/16	2-1/32	3/4	1/8	YES	ST05140-075F
	7xD	4-9/64	5-13/64	5-5/16	7-15/64	2-1/32	3/4	1/8	YES	ST07140-075F
m	3xD	45.0	72.4	75.0	122.4	50	20	1/8*	YES	ST03140-20FM
	5xD	75.0	102.4	104.9	152.4	50	20	1/8*	YES	ST05140-20FM
	7xD	104.9	132.3	134.9	182.3	50	20	1/8*	YES	ST07140-20FM

*Thread to BSP and ISO 7-1

Connection Accessories

					Admissible Tightening Torque*
Insert Screws	Nylon Locking Screws	Insert Driver	Preset Torque Hand Driver	Replacement Tips	
7247-IP7-1	7247N-IP7-1	8IP-7	8IP-7TL	8IP-7B	7.4 in-lbs (84 N-cm)

*Tightening torques are calculated with a friction coefficient of $\mu = 0.14$ and develop 90% of ultimate yield strength

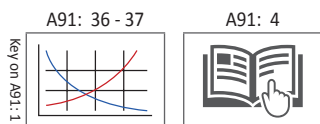

i = Imperial (in)
m = Metric (mm)

Inserts sold in multiples of 1 | Screws sold in multiples of 10

NOTICE: Structural Steel GEN3SYS XT holders are specifically designed to be used only with ST geometry inserts. Using other GEN3SYS XT or XT Pro insert geometries in these holders could lead to chip packing and tool failure. Contact Application Engineering for questions regarding proper use of tools.

GEN3SYS® XT Structural Steel Drilling System

15 Series | Diameter Range: 0.5906" - 0.6298" (15.00mm - 15.99mm)

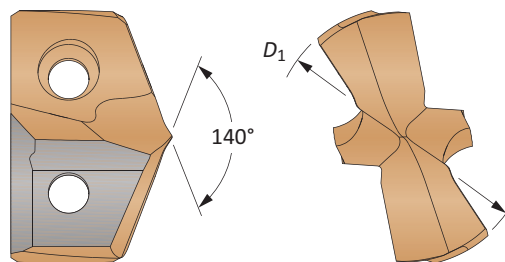
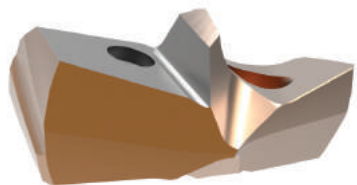

Inserts

Insert				
Carbide Substrate	Fractional Equivalent	D ₁ inch	D ₁ mm	Structural Steel Part No.
C2 (K20)	5/8	0.6250	15.88	7C215P-0020ST

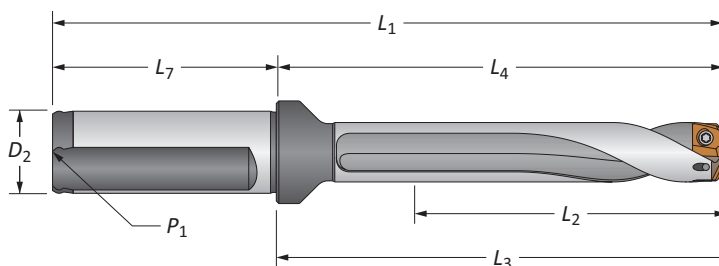





Holders

Length	Body				Shank				Flat	Part No.
	L ₂	L ₄	L ₃	L ₁	L ₇	D ₂	P ₁			
3xD	1-57/64	2-61/64	3-3/64	4-63/64	2-1/32	3/4	1/8	YES	ST03150-075F	
5xD	3-5/32	4-7/32	4-5/16	6-1/4	2-1/32	3/4	1/8	YES	ST05150-075F	
7xD	4-27/64	5-15/32	5-37/64	7-1/2	2-1/32	3/4	1/8	YES	ST07150-075F	
3xD	48.0	75.1	77.6	125.1	50	20	1/8*	YES	ST03150-20FM	
5xD	80.0	107.0	109.6	157.0	50	20	1/8*	YES	ST05150-20FM	
7xD	111.9	139.0	141.6	189.0	50	20	1/8*	YES	ST07150-20FM	

*Thread to BSP and ISO 7-1

Connection Accessories

					Admissible Tightening Torque*
7247-IP7-1	7247N-IP7-1	8IP-7	8IP-7TL	8IP-7B	7.4 in-lbs (84 N-cm)

*Tightening torques are calculated with a friction coefficient of $\mu = 0.14$ and develop 90% of ultimate yield strength

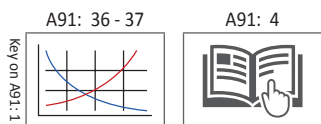

i = Imperial (in)
m = Metric (mm)

Inserts sold in multiples of 1 | Screws sold in multiples of 10

NOTICE: Structural Steel GEN3SYS XT holders are specifically designed to be used only with ST geometry inserts. Using other GEN3SYS XT or XT Pro insert geometries in these holders could lead to chip packing and tool failure. Contact Application Engineering for questions regarding proper use of tools.

GEN3SYS® XT Structural Steel Drilling System

16 Series | Diameter Range: 0.6299" - 0.6692" (16.00mm - 16.99mm)

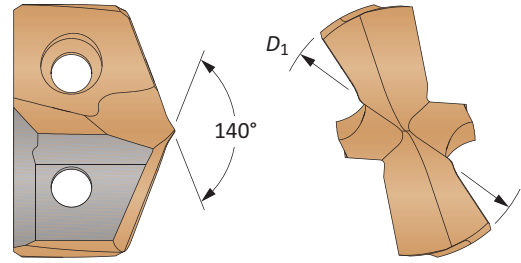
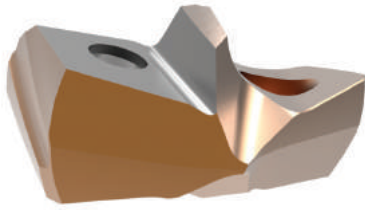

Inserts

Insert				
Carbide Substrate	Fractional Equivalent	D ₁ inch	D ₁ mm	Structural Steel Part No.
C2 (K20)	-	0.6299	16.00	7C216P-16ST

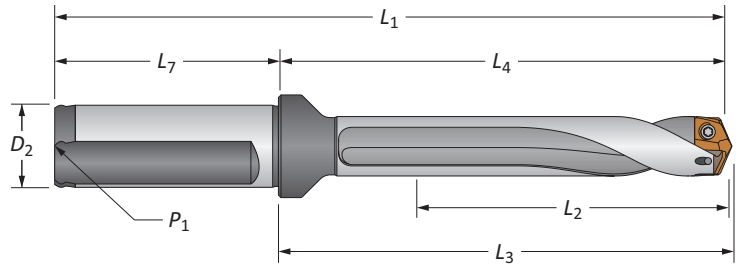





Holders

	Length	Body				Shank				Part No.
		L ₂	L ₄	L ₃	L ₁	L ₇	D ₂	P ₁	Flat	
i	3xD	3-1/64	3-13/64	3-5/16	5-15/64	2-1/32	3/4	1/8	YES	ST03160-075F
	5xD	3-23/64	4-17/32	4-21/32	6-9/16	2-1/32	3/4	1/8	YES	ST05160-075F
	7xD	4-11/16	5-7/8	5-63/64	7-29/32	2-1/32	3/4	1/8	YES	ST07160-075F
m	3xD	51.0	81.3	84.2	131.3	50	20	1/8*	YES	ST03160-20FM
	5xD	84.9	115.3	118.2	165.3	50	20	1/8*	YES	ST05160-20FM
	7xD	118.9	149.3	152.2	199.3	50	20	1/8*	YES	ST07160-20FM

*Thread to BSP and ISO 7-1

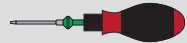
Connection Accessories

					Admissible Tightening Torque*
72556-IP8-1	72556N-IP8-1	8IP-8	8IP-8TL	8IP-8B	15.5 in-lbs (175 N-cm)

*Tightening torques are calculated with a friction coefficient of $\mu = 0.14$ and develop 90% of ultimate yield strength

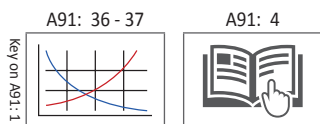

i = Imperial (in)
m = Metric (mm)

Inserts sold in multiples of 1 | Screws sold in multiples of 10

NOTICE: Structural Steel GEN3SYS XT holders are specifically designed to be used only with ST geometry inserts. Using other GEN3SYS XT or XT Pro insert geometries in these holders could lead to chip packing and tool failure. Contact Application Engineering for questions regarding proper use of tools.

GEN3SYS® XT Structural Steel Drilling System

17 Series | Diameter Range: 0.6693" - 0.7086" (17.00mm - 17.99mm)

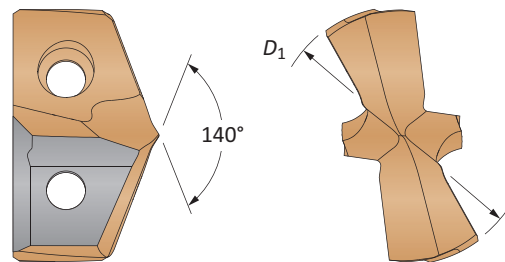
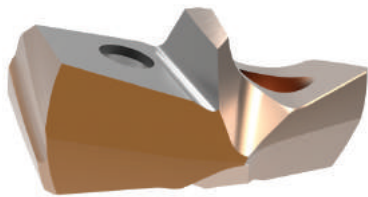

Inserts

Insert				
Carbide Substrate	Fractional Equivalent	D_1 inch	D_1 mm	Structural Steel Part No.
C2 (K20)	11/16	0.6875	17.46	7C217P-0022ST

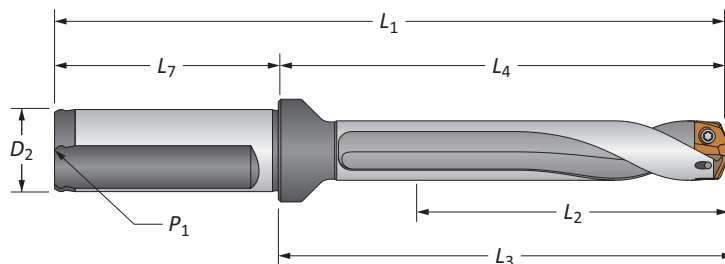





Holders

Length	Body				Shank				Flat	Part No.
	L_2	L_4	L_3	L_1	L_7	D_2	P_1			
3xD	2-1/8	3-5/16	3-27/64	5-11/32	2-1/32	3/4	1/8	YES	ST03170-075F	
5xD	3-35/64	4-23/32	4-27/32	6-3/4	2-1/32	3/4	1/8	YES	ST05170-075F	
7xD	4-31/32	6-9/64	6-1/4	8-11/64	2-1/32	3/4	1/8	YES	ST07170-075F	
3xD	54.0	84.1	87.0	134.1	50	20	1/8*	YES	ST03170-20FM	
5xD	89.9	120.0	122.9	170.0	50	20	1/8*	YES	ST05170-20FM	
7xD	125.9	156.0	158.9	206.0	50	20	1/8*	YES	ST07170-20FM	

*Thread to BSP and ISO 7-1

Connection Accessories

					Admissible Tightening Torque*
Insert Screws	Nylon Locking Screws	Insert Driver	Preset Torque Hand Driver	Replacement Tips	
72567-IP8-1	72567N-IP8-1	8IP-8	8IP-8TL	8IP-8B	15.5 in-lbs (175 N-cm)

*Tightening torques are calculated with a friction coefficient of $\mu = 0.14$ and develop 90% of ultimate yield strength

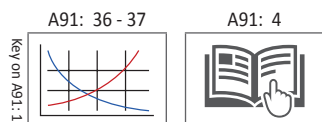

i = Imperial (in)
m = Metric (mm)

Inserts sold in multiples of 1 | Screws sold in multiples of 10

NOTICE: Structural Steel GEN3SYS XT holders are specifically designed to be used only with ST geometry inserts. Using other GEN3SYS XT or XT Pro insert geometries in these holders could lead to chip packing and tool failure. Contact Application Engineering for questions regarding proper use of tools.

GEN3SYS® XT Structural Steel Drilling System

18 Series | Diameter Range: 0.7087" - 0.7873" (18.00mm - 19.99mm)

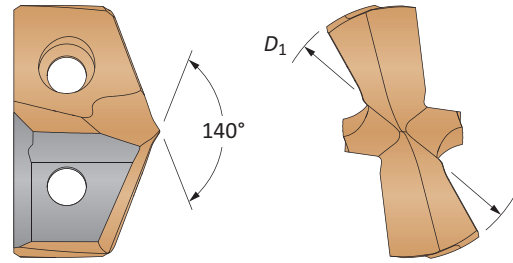
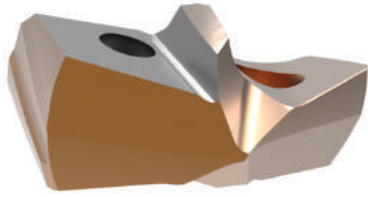

Inserts

Insert				
Carbide Substrate	Fractional Equivalent	D ₁ inch	D ₁ mm	Structural Steel Part No.
C2 (K20)	-	0.7087	18.00	7C218P-18ST

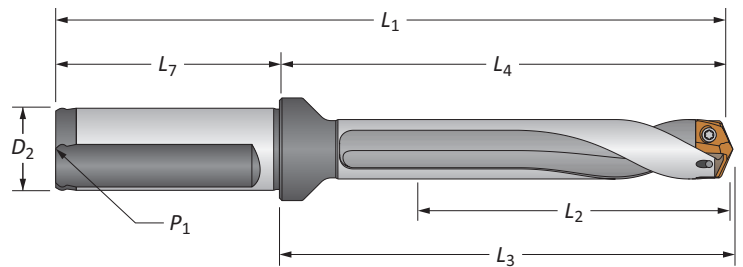





Holders

Length	Body				Shank				Flat	Part No.
	L ₂	L ₄	L ₃	L ₁	L ₇	D ₂	P ₁			
i 3xD	2-3/8	3-45/64	3-53/64	5-63/64	2-9/32	1	1/8	YES	ST03180-100F	
i 5xD	3-15/16	5-9/32	5-25/64	7-9/16	2-9/32	1	1/8	YES	ST05180-100F	
i 7xD	5-33/64	6-27/32	6-31/32	9-1/8	2-9/32	1	1/8	YES	ST07180-100F	
m 3xD	60.0	94.0	97.1	144.0	50	20	1/8*	YES	ST03180-20FM	
m 5xD	99.9	134.0	137.1	184.0	50	20	1/8*	YES	ST05180-20FM	
m 7xD	139.9	174.0	177.1	224.0	50	20	1/8*	YES	ST07180-20FM	

*Thread to BSP and ISO 7-1

Connection Accessories

					Admissible Tightening Torque*
Insert Screws 7375-IP9-1	Nylon Locking Screws 7375N-IP9-1	Insert Driver 8IP-9	Preset Torque Hand Driver 8IP-9TL	Replacement Tips 8IP-9B	27.0 in-lbs (305 N-cm)

*Tightening torques are calculated with a friction coefficient of $\mu = 0.14$ and develop 90% of ultimate yield strength

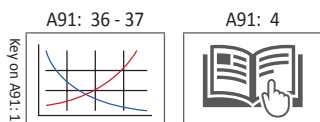

i = Imperial (in)
m = Metric (mm)

Inserts sold in multiples of 1 | Screws sold in multiples of 10

NOTICE: Structural Steel GEN3SYS XT holders are specifically designed to be used only with ST geometry inserts. Using other GEN3SYS XT or XT Pro insert geometries in these holders could lead to chip packing and tool failure. Contact Application Engineering for questions regarding proper use of tools.

**GEN3SYS® XT Structural Steel Drilling System**

20 Series | Diameter Range: 0.7874" - 0.8660" (20.00mm - 21.99mm)

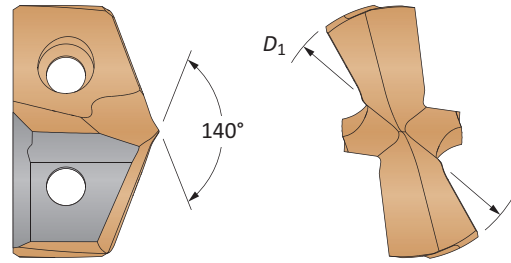
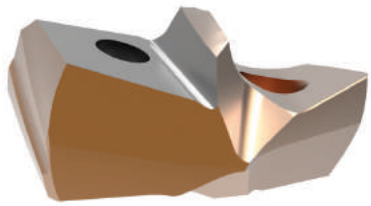
**Inserts**



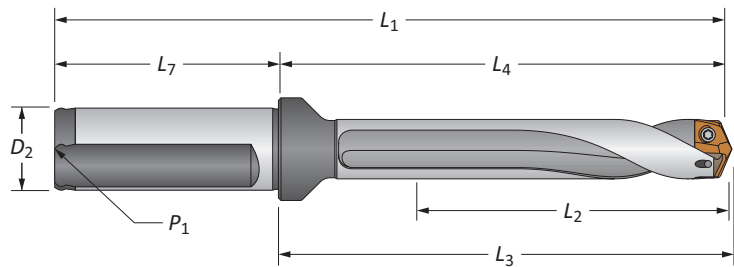

Carbide Substrate	Insert			 Structural Steel Part No.
	Fractional Equivalent	D_1 inch	D_1 mm	
C2 (K20)	–	0.7874	20.00	7C220P-20ST
	13/16	0.8125	20.64	7C220P-0026ST

**Holders**

Length	Body				Shank				Flat	Part No.
	L_2	L_4	L_3	L_1	L_7	D_2	P_1			
i 3xD	2-17/32	3-15/16	4-1/16	6-7/32	2-9/32	1	1/8	YES	ST03200-100F	
i 5xD	4-11/32	5-43/64	5-51/64	7-61/64	2-9/32	1	1/8	YES	ST05200-100F	
i 7xD	6-1/16	7-13/32	7-17/32	9-11/16	2-9/32	1	1/8	YES	ST07200-100F	
m 3xD	66.0	100.1	103.3	156.1	56	25	1/8*	YES	ST03200-25FM	
m 5xD	110.0	144.1	147.2	200.1	56	25	1/8*	YES	ST05200-25FM	
m 7xD	153.9	188.1	191.2	244.1	56	25	1/8*	YES	ST07200-25FM	

*Thread to BSP and ISO 7-1

Connection Accessories

 Insert Screws	 Nylon Locking Screws	 Insert Driver	 Preset Torque Hand Driver	 Replacement Tips	Admissible Tightening Torque*
7375-IP9-1	7375N-IP9-1	8IP-9	8IP-9TL	8IP-9B	27.0 in-lbs (305 N-cm)

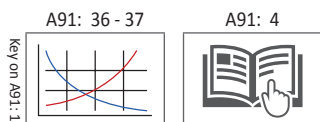
*Tightening torques are calculated with a friction coefficient of $\mu = 0.14$ and develop 90% of ultimate yield strength**i** = Imperial (in)
m = Metric (mm)

Inserts sold in multiples of 1 | Screws sold in multiples of 10

NOTICE: Structural Steel GEN3SYS XT holders are specifically designed to be used only with ST geometry inserts. Using other GEN3SYS XT or XT Pro insert geometries in these holders could lead to chip packing and tool failure. Contact Application Engineering for questions regarding proper use of tools.

GEN3SYS® XT Structural Steel Drilling System

22 Series | Diameter Range: 0.8661" - 0.9448" (22.00mm - 23.99mm)

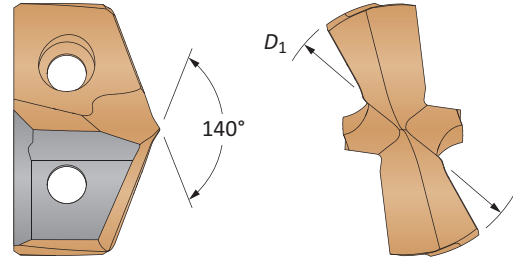
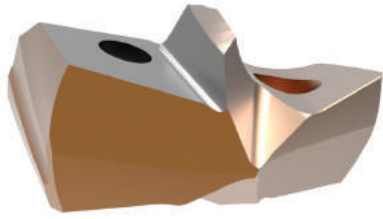

Inserts

Insert				
Carbide Substrate	Fractional Equivalent	D ₁ inch	D ₁ mm	Structural Steel Part No.
C2 (K20)	–	0.8661	22.00	7C222P-22ST
	7/8	0.8750	22.23	7C222P-0028ST
	15/16	0.9375	23.81	7C222P-0030ST

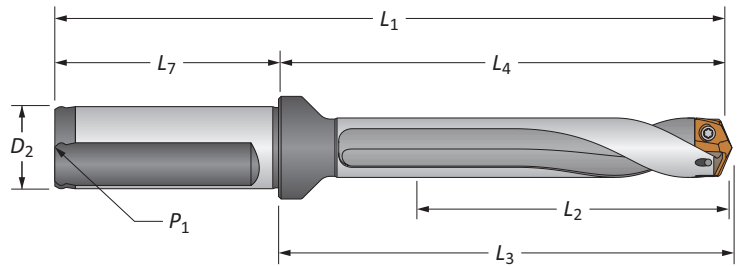





Holders

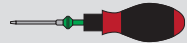

Length	Body				Shank				Flat	Part No.
	L ₂	L ₄	L ₃	L ₁	L ₇	D ₂	P ₁			
i	3xD	2-53/64	4-9/64	4-9/32	6-27/64	2-9/32	1	1/8	YES	ST03220-100F
	3xD	2-53/64	4-9/64	4-9/32	6-27/64	2-9/32	1	1/8	YES	ST03225-100F**
	5xD	4-23/32	6-1/32	6-11/64	8-5/16	2-9/32	1	1/8	YES	ST05220-100F
	5xD	4-23/32	6-1/32	6-11/64	8-5/16	2-9/32	1	1/8	YES	ST05225-100F**
	7xD	6-39/64	7-59/64	8-1/16	10-13/64	2-9/32	1	1/8	YES	ST07220-100F
	7xD	6-39/64	7-59/64	8-1/16	10-13/64	2-9/32	1	1/8	YES	ST07225-100F**
m	3xD	72.0	105.3	108.7	161.3	56	25	1/8*	YES	ST03220-25FM
	3xD	72.0	105.3	108.7	161.3	56	25	1/8*	YES	ST03225-25FM**
	5xD	119.9	153.3	156.7	209.3	56	25	1/8*	YES	ST05220-25FM
	5xD	119.9	153.3	156.7	209.3	56	25	1/8*	YES	ST05225-25FM**
	7xD	167.9	201.3	204.7	257.3	56	25	1/8*	YES	ST07220-25FM
	7xD	167.9	201.3	204.7	257.3	56	25	1/8*	YES	ST07225-25FM**

*Thread to BSP and ISO 7-1 | **Oversized body holder (minimum drill diameter = 23mm)

Connection Accessories

					Admissible Tightening Torque*
739-IP9-1	739N-IP9-1	8IP-9	8IP-9TL	8IP-9B	27.0 in-lbs (305 N-cm)

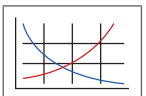
*Tightening torques are calculated with a friction coefficient of $\mu = 0.14$ and develop 90% of ultimate yield strength

A91: 36 - 37  A91: 4 

Key on A91: 1

i = Imperial (in)
m = Metric (mm)

Inserts sold in multiples of 1 | Screws sold in multiples of 10

NOTICE: Structural Steel GEN3SYS XT holders are specifically designed to be used only with ST geometry inserts. Using other GEN3SYS XT or XT Pro insert geometries in these holders could lead to chip packing and tool failure. Contact Application Engineering for questions regarding proper use of tools.

A
DRILLING
B
BORING
C
REAMING
D
BURNISHING
E
THREADING
X
SPECIALS

GEN3SYS® XT Structural Steel Drilling System

24 Series | Diameter Range: 0.9449" - 1.0235" (24.00mm - 25.99mm)

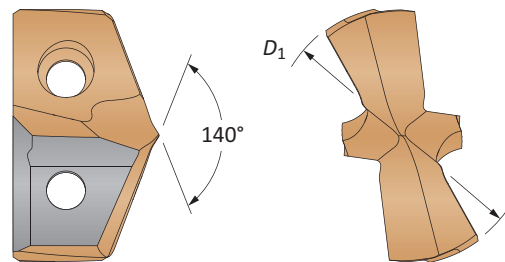
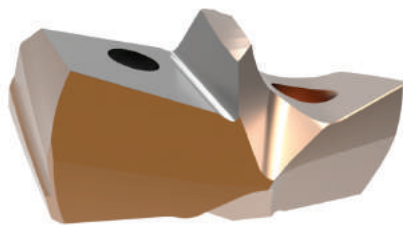

Inserts

Carbide Substrate	Insert			Structural Steel Part No.
	Fractional Equivalent	D_1 inch	D_1 mm	
C2 (K20)	–	0.9449	24.00	7C224P-24ST
	1	1.0000	25.40	7C224P-0100ST



Structural Steel Part No.

7C224P-24ST

7C224P-0100ST

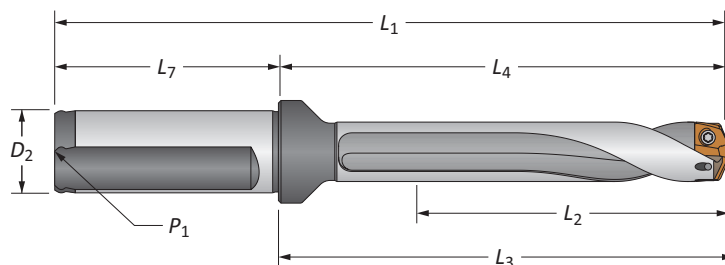

Holders

Length	Body				Shank				Flat	Part No.
	L_2	L_4	L_3	L_1	L_7	D_2	P_1			
3xD	3-5/64	4-31/64	4-5/8	6-49/64	2-9/32	1	1/8	YES	ST03240-100F	
5xD	5-1/8	6-17/32	6-21/32	8-13/16	2-9/32	1	1/8	YES	ST05240-100F	
7xD	7-11/64	8-37/64	8-45/64	10-55/64	2-9/32	1	1/8	YES	ST07240-100F	
3xD	78.0	113.8	117.3	169.8	56	25	1/8*	YES	ST03240-25FM	
5xD	129.9	165.8	169.2	221.8	56	25	1/8*	YES	ST05240-25FM	
7xD	181.9	217.8	221.2	273.8	56	25	1/8*	YES	ST07240-25FM	

*Thread to BSP and ISO 7-1

Connection Accessories

Insert Screws	Nylon Locking Screws	Insert Driver	Preset Torque Hand Driver	Replacement Tips	Admissible Tightening Torque*
739-IP9-1	739N-IP9-1	8IP-9	8IP-9TL	8IP-9B	27.0 in-lbs (305 N-cm)

*Tightening torques are calculated with a friction coefficient of $\mu = 0.14$ and develop 90% of ultimate yield strength

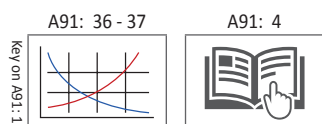

i = Imperial (in)
m = Metric (mm)

Inserts sold in multiples of 1 | Screws sold in multiples of 10

NOTICE: Structural Steel GEN3SYS XT holders are specifically designed to be used only with ST geometry inserts. Using other GEN3SYS XT or XT Pro insert geometries in these holders could lead to chip packing and tool failure. Contact Application Engineering for questions regarding proper use of tools.

GEN3SYS® XT Structural Steel Drilling System

26 Series | Diameter Range: 1.0236" - 1.1416" (26.00mm - 28.99mm)

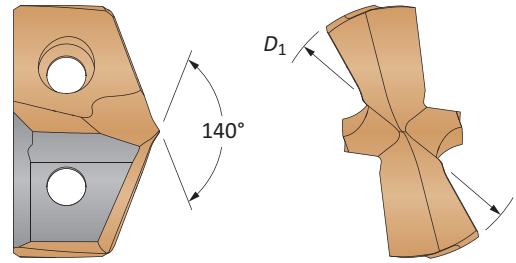
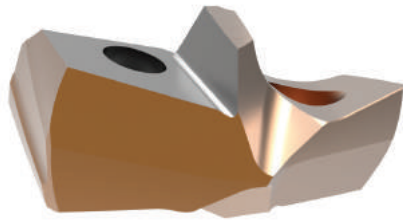

Inserts

Carbide Substrate	Insert			Structural Steel Part No.
	Fractional Equivalent	D ₁ inch	D ₁ mm	
C2 (K20)	-	1.0236	26.00	7C226P-26ST
	1-1/16	1.0625	26.99	7C226P-0102ST
	-	1.0630	27.00	7C226P-27ST
	-	1.1024	28.00	7C226P-28ST
	1-1/8	1.1250	28.58	7C226P-0104ST

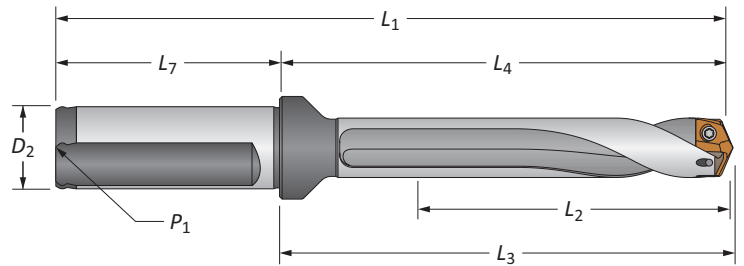

Holders

Length	Body				Shank				Part No.
	L ₂	L ₄	L ₃	L ₁	L ₇	D ₂	P ₁	Flat	
3xD	3-27/64	5-1/16	5-3/16	7-11/32	2-9/32	1-1/4	1/4	YES	ST03260-125F
5xD	5-23/32	7-11/32	7-31/64	9-5/8	2-9/32	1-1/4	1/4	YES	ST05260-125F
7xD	7-63/64	9-5/8	9-49/64	11-29/32	2-9/32	1-1/4	1/4	YES	ST07260-125F
3xD	87.0	128.1	131.4	188.1	60	32	1/4*	YES	ST03260-32FM
5xD	145.0	186.1	189.4	246.1	60	32	1/4*	YES	ST05260-32FM
7xD	202.9	244.0	247.4	304.0	60	32	1/4*	YES	ST07260-32FM

*Thread to BSP and ISO 7-1

Connection Accessories

Insert Screws	Nylon Locking Screws	Insert Driver	Preset Torque Hand Driver	Replacement Tips	Admissible Tightening Torque*
7495-IP15-1	7495N-IP15-1	8IP-15	8IP-15TL	8IP-15B	61.0 in-lbs (690 N-cm)

*Tightening torques are calculated with a friction coefficient of $\mu = 0.14$ and develop 90% of ultimate yield strength

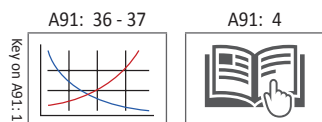

ⓘ = Imperial (in)
Ⓜ = Metric (mm)

Inserts sold in multiples of 1 | Screws sold in multiples of 10

NOTICE: Structural Steel GEN3SYS XT holders are specifically designed to be used only with ST geometry inserts. Using other GEN3SYS XT or XT Pro insert geometries in these holders could lead to chip packing and tool failure. Contact Application Engineering for questions regarding proper use of tools.

A DRILLING
B BORING
C REAMING
D BURNISHING
E THREADING
X SPECIALS

GEN3SYS® XT Structural Steel Drilling System

29 Series | Diameter Range: 1.1417" - 1.2597" (29.00mm - 31.99mm)

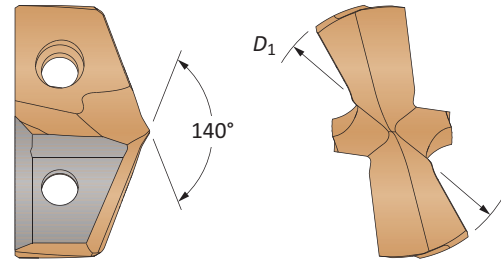
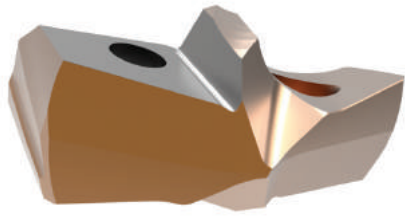

Inserts

Carbide Substrate	Insert			Structural Steel Part No.
	Fractional Equivalent	D_1 inch	D_1 mm	
C2 (K20)	-	1.1417	29.00	7C229P-29ST
	-	1.1811	30.00	7C229P-30ST
	1-3/16	1.1875	30.16	7C229P-0106ST
	-	1.2205	31.00	7C229P-31ST
	1-1/4	1.2500	31.75	7C229P-0108ST

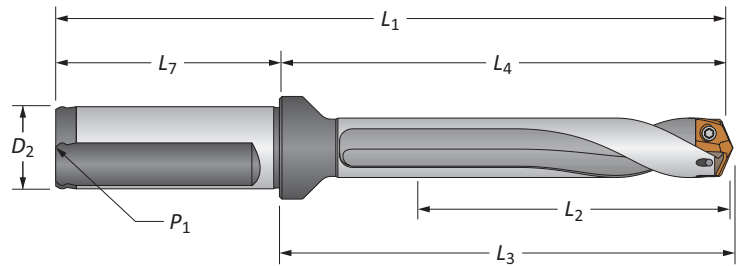

Holders

Length	Body				Shank				Flat	Part No.
	L_2	L_4	L_3	L_1	L_7	D_2	P_1			
3xD	3-25/32	5-3/8	5-33/64	7-21/32	2-9/32	1-1/4	1/4	YES	ST03290-125F	
5xD	6-19/64	7-29/32	8-3/64	10-3/16	2-9/32	1-1/4	1/4	YES	ST05290-125F	
7xD	8-13/16	10-27/64	10-9/16	12-45/64	2-9/32	1-1/4	1/4	YES	ST07290-125F	
3xD	96.0	136.2	139.7	196.2	60	32	1/4*	YES	ST03290-32FM	
5xD	159.9	200.1	203.7	260.1	60	32	1/4*	YES	ST05290-32FM	
7xD	223.9	264.1	267.7	324.1	60	32	1/4*	YES	ST07290-32FM	

*Thread to BSP and ISO 7-1

Connection Accessories

Insert Screws	Nylon Locking Screws	Insert Driver	Preset Torque Hand Driver	Replacement Tips	Admissible Tightening Torque*
7495-IP15-1	7495N-IP15-1	8IP-15	8IP-15TL	8IP-15B	61.0 in-lbs (690 N-cm)

*Tightening torques are calculated with a friction coefficient of $\mu = 0.14$ and develop 90% of ultimate yield strength

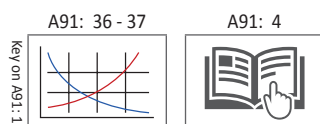

i = Imperial (in)
m = Metric (mm)

Inserts sold in multiples of 1 | Screws sold in multiples of 10

NOTICE: Structural Steel GEN3SYS XT holders are specifically designed to be used only with ST geometry inserts. Using other GEN3SYS XT or XT Pro insert geometries in these holders could lead to chip packing and tool failure. Contact Application Engineering for questions regarding proper use of tools.

GEN3SYS® XT Structural Steel Drilling System

32 Series | Diameter Range: 1.2598" - 1.3780" (32.00mm - 35.00mm)

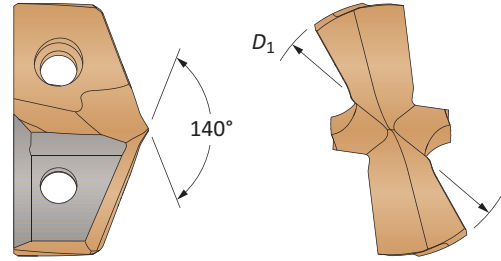
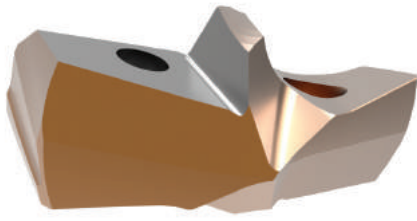

Inserts

Insert				
Carbide Substrate	Fractional Equivalent	D ₁ inch	D ₁ mm	Structural Steel Part No.
C2 (K20)	-	1.2598	32.00	7C232P-32ST
	-	1.2992	33.00	7C232P-33ST
	1-5/16	1.3125	33.34	7C232P-0110ST
	1-3/8	1.3750	34.93	7C232P-0112ST

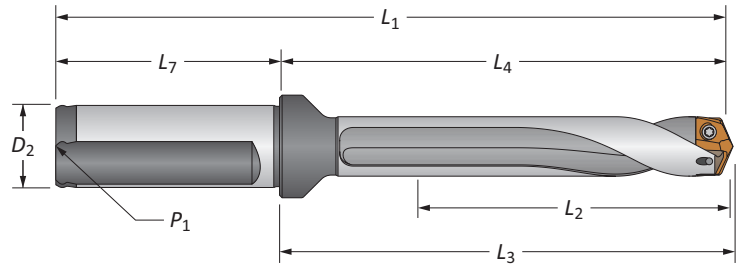





Holders

	Length	Body				Shank				Part No.
		L ₂	L ₄	L ₃	L ₁	L ₇	D ₂	P ₁	Flat	
i	3xD	4-9/64	6-7/32	6-3/8	8-29/32	2-11/16	1-1/2	1/4	YES	ST03320-150F
	5xD	6-59/64	8-31/32	9-1/8	11-21/32	2-11/16	1-1/2	1/4	YES	ST05320-150F
	7xD	9-41/64	11-23/32	11-57/64	14-13/32	2-11/16	1-1/2	1/4	YES	ST07320-150F
m	3xD	105.0	157.7	162.0	217.7	60	32	1/4*	YES	ST03320-32FM
	3xD	105.0	157.7	162.0	227.7	70	40	1/4*	YES	ST03320-40FM
	5xD	175.0	227.7	232.0	287.7	60	32	1/4*	YES	ST05320-32FM
	5xD	175.0	227.7	232.0	297.7	70	40	1/4*	YES	ST05320-40FM
	7xD	244.9	297.7	302.2	357.7	60	32	1/4*	YES	ST07320-32FM
	7xD	244.9	297.7	302.2	367.7	70	40	1/4*	YES	ST07320-40FM

*Thread to BSP and ISO 7-1

Connection Accessories

					Admissible Tightening Torque*
7495-IP15-1	7495N-IP15-1	8IP-15	8IP-15TL	8IP-15B	61.0 in-lbs (690 N-cm)

*Tightening torques are calculated with a friction coefficient of μ = 0.14 and develop 90% of ultimate yield strength

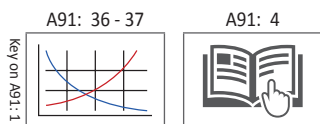

i = Imperial (in)
m = Metric (mm)

Inserts sold in multiples of 1 | Screws sold in multiples of 10

NOTICE: Structural Steel GEN3SYS XT holders are specifically designed to be used only with ST geometry inserts. Using other GEN3SYS XT or XT Pro insert geometries in these holders could lead to chip packing and tool failure. Contact Application Engineering for questions regarding proper use of tools.

A
DRILLING
B
BORING
C
REAMING
D
BURNISHING
E
THREADING
X
SPECIALS

Original T-A® Structural Steel Drill Inserts

0 Series | Diameter Range: 0.5512" - 0.6875" (14.00mm - 17.46mm)



Thin Wall

For material up to 7/16" thick

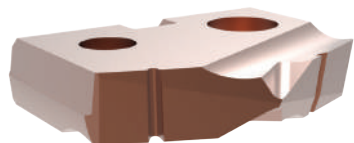
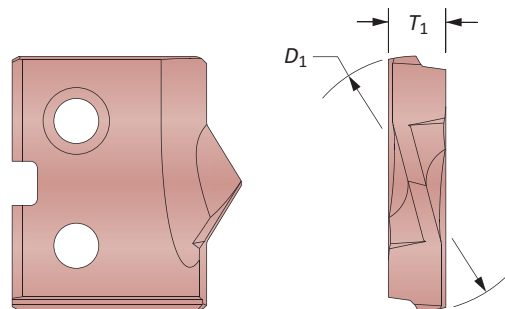

Notch Point®

For material over 7/16" thick

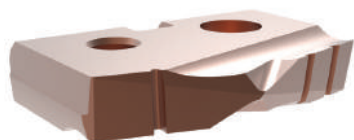
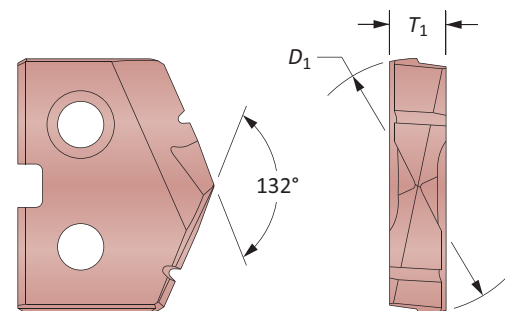

150° Structural Steel

For material over 7/16" thick and for reduced exit burr

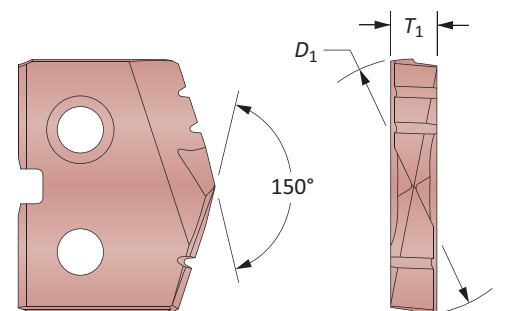

HSS Inserts – Super Cobalt

Series	Insert					Thin Wall		Notch Point		150° Structural Steel	
	Fractional Equivalent	D_1 inch	D_1 mm	T_1							
					AM200 Part No.	TiAlN Part No.	AM200 Part No.	TiAlN Part No.	AM200 Part No.	TiAlN Part No.	
0	–	0.5512	14.00	1/8	150H-14-TW	150A-14-TW	150H-14-NP	150A-14-NP	150H-14-SS	150A-14-SS	
	9/16	0.5625	14.29	1/8	150H-0018-TW	150A-0018-TW	150H-0018-NP	150A-0018-NP	150H-0018-SS	150A-0018-SS	
0.5	5/8	0.6250	15.88	1/8	150H-0020-TW	150A-0020-TW	150H-0020-NP	150A-0020-NP	150H-0020-SS	150A-0020-SS	
	–	0.6299	16.00	1/8	150H-16-TW	150A-16-TW	150H-16-NP	150A-16-NP	150H-16-SS	150A-16-SS	
	11/16	0.6875	17.46	1/8	150H-0022-TW	150A-0022-TW	150H-0022-NP	150A-0022-NP	150H-0022-SS	150A-0022-SS	

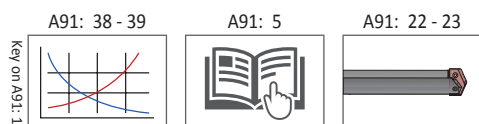



GEN2 T-A® Structural Steel Drill Inserts

0 Series | Diameter Range: 0.5512" - 0.6875" (14.00mm - 17.46mm)

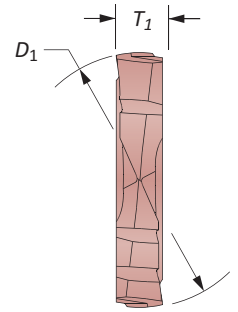
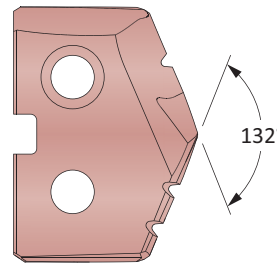

HSS Inserts – Super Cobalt | Carbide Inserts – C1 (K35)

Series	Fractional Equivalent	Insert			Part No.	
		D_1 inch	D_1 mm	T_1	Super Cobalt	C1 (K35)
0	–	0.5512	14.00	1/8	450H-14-HE	4C10H-14-HE
	9/16	0.5625	14.29	1/8	450H-0018-HE	4C10H-0018-HE
0.5	5/8	0.6250	15.88	1/8	450H-0020-HE	4C10H-0020-HE
	–	0.6299	16.00	1/8	450H-16-HE	4C10H-16-HE
	11/16	0.6875	17.46	1/8	450H-0022-HE	4C10H-0022-HE

Key on A91-1

A91: 38 - 39

A91: 5

A91: 22 - 23

Inserts sold in multiples of 2

T-A® Structural Steel Drill Insert Holders

0 Series | Taper Shank

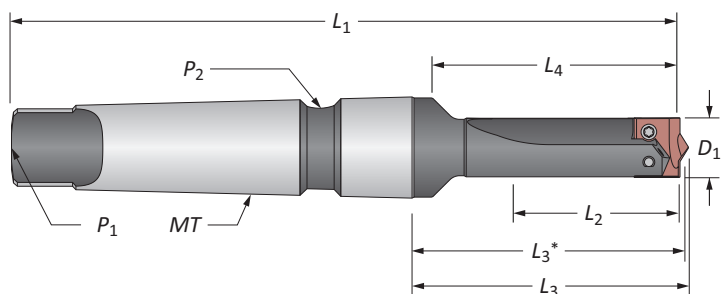





Straight Flute #3 Morse Taper

Series	Length	D_1	Body					Shank			Part No.	
			L_2	L_4	L_3	L_3^*	L_1	MT	P_1	P_2		
i	0	Short	9/16	1-3/8	2-3/16	2-35/64	2-31/64	6-1/16	#3	TTC	TSC	22000S-003IS036
	0.5	Short	5/8	1-3/8	2-3/16	2-35/64	2-31/64	6-1/16	#3	TTC	TSC	22005S-003IS040
		Short	11/16	1-3/8	2-3/16	2-35/64	2-31/64	6-1/16	#3	TTC	TSC	22005S-003IS044
m	0	Short	14	35	56	64.7	63.1	154	#3	TTC	TSC	22000S-003IS036
		Short	16	35	56	64.7	63.1	154	#3	TTC	TSC	22000S-003IS040
		Short	17.5	35	56	64.7	63.1	154	#3	TTC	TSC	22000S-003IS044

*If using Structural Steel holder with Notch Point®, GEN2 T-A, or 150° Structural Steel T-A drill insert geometry

Connection Accessories

Series	 Insert Screws	 Nylon Locking Screws	 Insert Driver	 Preset Torque Hand Driver	 Replacement Tips	Admissible Tightening Torque*
0	72556-IP8-1	72556N-IP8-1	8IP-8	8IP-8TL	8IP-8B	15.5 in-lbs (175 N-cm)
0.5	72567-IP8-1	72567N-IP8-1	8IP-8	8IP-8TL	8IP-8B	15.5 in-lbs (175 N-cm)

*Tightening torques are calculated with a friction coefficient of $\mu = 0.14$ and develop 90% of ultimate yield strength

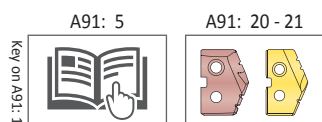

i = Imperial (in)
m = Metric (mm)

Screws sold in multiples of 10



T-A® Structural Steel Drill Insert Holders

O Series | Taper Shank

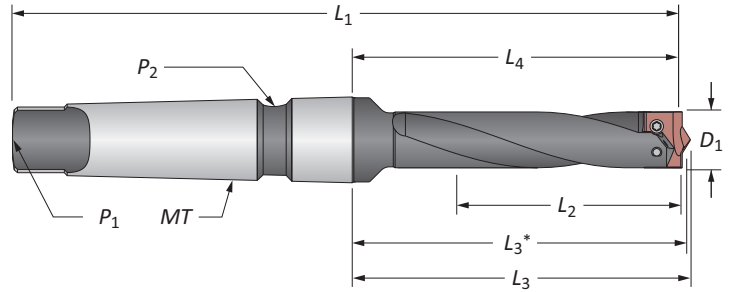

Helical Flute #3 Morse Taper

Series	Length	D ₁	Body					Shank			Part No.	
			L ₂	L ₄	L ₃	L ₃ *	L ₁	MT	P ₁	P ₂		
i	0	Standard	9/16	2-1/2	3-5/16	3-43/64	3-39/64	7-3/16	#3	TTC	TSC	24000H-003IS036
		Extended	9/16	6-1/2	9-7/16	9-51/64	9-19/32	13-5/64	#3	TTC	TSC	⚠ 25000H-003IS036
	0.5	Standard	5/8	2-1/2	3-5/16	3-43/64	3-39/64	7-3/16	#3	TTC	TSC	24005H-003IS040
		Extended	11/16	6-1/2	9-7/16	9-51/64	9-19/32	13-5/64	#3	TTC	TSC	⚠ 25005H-003IS044
m	0	Standard	14	64	84	93.3	91.7	183	#3	TTC	TSC	24000H-003IS036
		Extended	14	165	240	248.8	243.7	338	#3	TTC	TSC	⚠ 25000H-003IS036
	0.5	Standard	16	64	84	93.3	91.7	183	#3	TTC	TSC	24005H-003IS040
		Standard	17.5	64	84	93.3	91.7	183	#3	TTC	TSC	24005H-003IS044
		Extended	17.5	165	240	248.8	243.7	338	#3	TTC	TSC	⚠ 25005H-003IS044

*If using Structural Steel holder with Notch Point®, GEN2 T-A, or 150° Structural Steel T-A drill insert geometry

i = Imperial (in)
m = Metric (mm)

Screws sold in multiples of 10

⚠ WARNING Refer to Speed and Feed charts for recommended adjustments to speeds and feeds. Refer to page A91: 35 for deep hole drilling guidelines in this section of the catalog. Visit www.alliedmachine.com/DeepHoleGuidelines for the most up-to-date information and procedures. Factory technical assistance is available for your specific applications through our Application Engineering Team.

**Original T-A® Structural Steel Drill Inserts**

1 Series | Diameter Range: 0.7087" - 0.9449" (18.00mm - 24.00mm)

**Thin Wall**

For material up to 7/16" thick

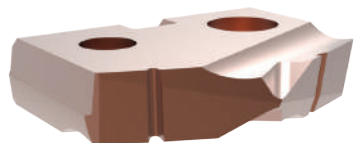
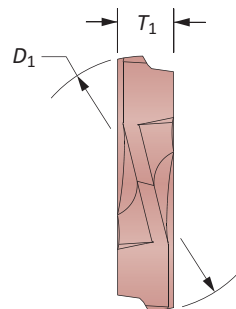
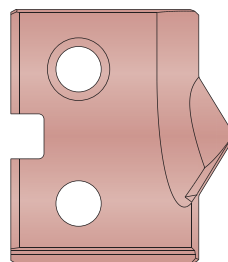



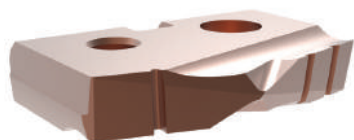
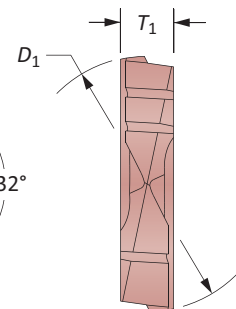
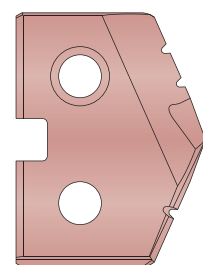

**Notch Point®**

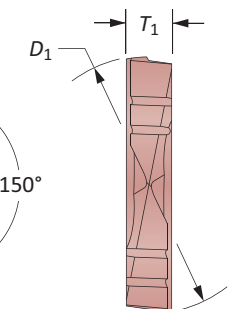
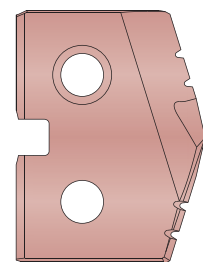
For material over 7/16" thick

**150° Structural Steel**

For material over 7/16" thick and for reduced exit burr

**HSS Inserts – Super Cobalt**

Series	Insert				Thin Wall		Notch Point		150° Structural Steel	
	Fractional Equivalent	D ₁ inch	D ₁ mm	T ₁	 AM200 Part No.	 TiAlN Part No.	 AM200 Part No.	 TiAlN Part No.	 AM200 Part No.	 TiAlN Part No.
1	–	0.7087	18.00	5/32	151H-18-TW	151A-18-TW	151H-18-NP	151A-18-NP	151H-18-SS	151A-18-SS
	13/16	0.8125	20.64	5/32	151H-0026-TW	151A-0026-TW	151H-0026-NP	151A-0026-NP	151H-0026-SS	151A-0026-SS
	–	0.8268	21.00	5/32	151H-21-TW	151A-21-TW	151H-21-NP	151A-21-NP	151H-21-SS	151A-21-SS
	–	0.8661	22.00	5/32	151H-22-TW	151A-22-TW	151H-22-NP	151A-22-NP	151H-22-SS	151A-22-SS
1.5	7/8	0.8750	22.23	5/32	151H-0028-TW	151A-0028-TW	151H-0028-NP	151A-0028-NP	151H-0028-SS	151A-0028-SS
	15/16	0.9375	23.81	5/32	151H-0030-TW	151A-0030-TW	151H-0030-NP	151A-0030-NP	151H-0030-SS	151A-0030-SS
	–	0.9449	24.00	5/32	151H-24-TW	151A-24-TW	151H-24-NP	151A-24-NP	151H-24-SS	151A-24-SS

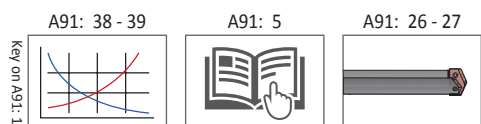



Inserts sold in multiples of 2

GEN2 T-A® Structural Steel Drill Inserts

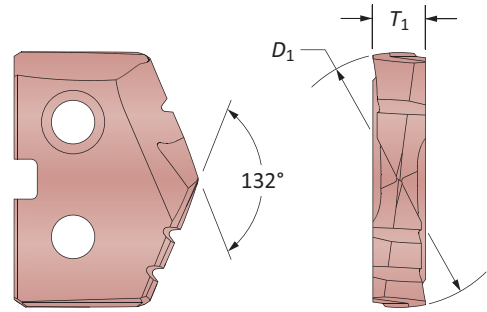
1 Series | Diameter Range: 0.7087" - 0.9449" (18.00mm - 24.00mm)



HSS Inserts – Super Cobalt | Carbide Inserts – C1 (K35)

Series	Fractional Equivalent	Insert			Part No.	
		D ₁ inch	D ₁ mm	T ₁	 Super Cobalt	 C1 (K35)
1	–	0.7087	18.00	5/32	451H-18-HE	4C11H-18-HE
	13/16	0.8125	20.64	5/32	451H-0026-HE	4C11H-0026-HE
	–	0.8268	21.00	5/32	451H-21-HE	4C11H-21-HE
	–	0.8661	22.00	5/32	451H-22-HE	4C11H-22-HE
1.5	7/8	0.8750	22.23	5/32	451H-0028-HE	4C11H-0028-HE
	15/16	0.9375	23.81	5/32	451H-0030-HE	4C11H-0030-HE
	–	0.9449	24.00	5/32	451H-24-HE	4C11H-24-HE

Key on A91-1

A91: 38 - 39

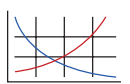

A91: 5



A91: 26 - 27



Inserts sold in multiples of 2

T-A® Structural Steel Drill Insert Holders

1 Series | Taper Shank

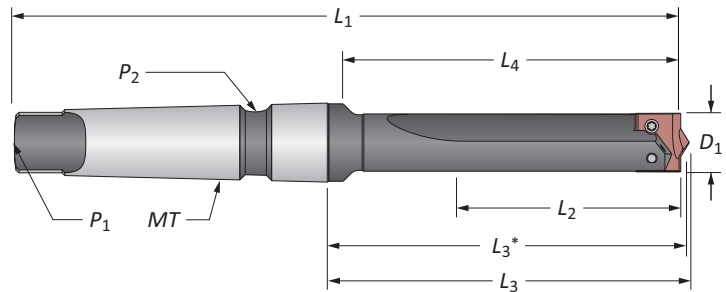

Straight Flute #3 Morse Taper

Series	Length	D_1	Body					Shank			Part No.	
			L_2	L_4	L_3	L_3^*	L_1	MT	P_1	P_2		
i	1	Short	18mm	2-3/4	3-7/8	4-17/64	4-13/64	7-3/4	#3	TTC	TSC	22010S-003IS045
		Short	13/16	2-3/4	3-7/8	4-17/64	4-13/64	7-3/4	#3	TTC	TSC	22010S-003IS052
	1.5	Short	7/8	2-3/4	3-7/8	4-17/64	4-13/64	7-3/4	#3	TTC	TSC	22015S-003IS056
		Short	15/16	2-3/4	3-7/8	4-17/64	4-13/64	7-3/4	#3	TTC	TSC	22015S-003IS060
m	1	Short	18	70	98	108.4	106.8	197	#3	TTC	TSC	22010S-003IS045
		Short	21	70	98	108.4	106.8	197	#3	TTC	TSC	22010S-003IS052
	1.5	Short	22	70	98	108.4	106.8	197	#3	TTC	TSC	22015S-003IS056
		Short	24	70	98	108.4	106.8	197	#3	TTC	TSC	22015S-003IS060





*If using Structural Steel holder with Notch Point®, GEN2 T-A, or 150° Structural Steel T-A drill insert geometry

Straight Flute #4 Morse Taper

Series	Length	D_1	Body					Shank			Part No.	
			L_2	L_4	L_3	L_3^*	L_1	MT	P_1	P_2		
i	1	Short	18mm	2-3/4	3-7/8	4-21/64	4-17/64	8-3/4	#4	TTC	TSC	22010S-004IS045
		Short	13/16	2-3/4	3-7/8	4-21/64	4-17/64	8-3/4	#4	TTC	TSC	22010S-004IS052
	1.5	Short	7/8	2-3/4	3-7/8	4-21/64	4-17/64	8-3/4	#4	TTC	TSC	22015S-004IS056
		Short	15/16	2-3/4	3-7/8	4-21/64	4-17/64	8-3/4	#4	TTC	TSC	22015S-004IS060
m	1	Short	18	70	98	109.9	108.3	222	#4	TTC	TSC	22010S-004IS045
		Short	21	70	98	109.9	108.3	222	#4	TTC	TSC	22010S-004IS052
	1.5	Short	22	70	98	109.9	108.3	222	#4	TTC	TSC	22015S-004IS056
		Short	24	70	98	109.9	108.3	222	#4	TTC	TSC	22015S-004IS060

*If using Structural Steel holder with Notch Point®, GEN2 T-A, or 150° Structural Steel T-A drill insert geometry

Connection Accessories

Series	 Insert Screws	 Nylon Locking Screws	 Insert Driver	 Preset Torque Hand Driver	 Replacement Tips	Admissible Tightening Torque*
1	7375-IP9-1	7375N-IP9-1	8IP-9	8IP-9TL	8IP-9B	27.0 in-lbs (305 N-cm)
1.5	739-IP9-1	739N-IP9-1	8IP-9	8IP-9TL	8IP-9B	27.0 in-lbs (305 N-cm)

*Tightening torques are calculated with a friction coefficient of $\mu = 0.14$ and develop 90% of ultimate yield strength

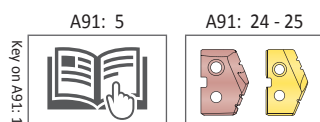

i = Imperial (in)
m = Metric (mm)

Screws sold in multiples of 10



T-A® Structural Steel Drill Insert Holders

1 Series | Taper Shank

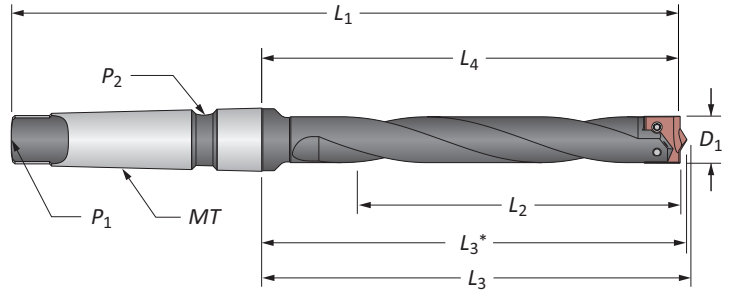

Helical Flute #3 Morse Taper

Series	Length	D ₁	Body					Shank			Part No.	
			L ₂	L ₄	L ₃	L ₃ *	L ₁	MT	P ₁	P ₂		
i	1	Standard	18mm	4-3/4	5-7/8	6-17/64	6-13/64	9-3/4	#3	TTC	TSC	24010H-003IS045
		Standard	13/16	4-3/4	5-7/8	6-17/64	6-13/64	9-3/4	#3	TTC	TSC	24010H-003IS052
		Extended	18mm	6-1/2	9-11/32	9-47/64	9-1/2	13-7/32	#3	TTC	TSC	⚠ 25010H-003IS045
	1.5	Standard	7/8	4-3/4	5-7/8	6-17/64	6-13/64	9-3/4	#3	TTC	TSC	24015H-003IS056
		Standard	15/16	4-3/4	5-7/8	6-17/64	6-13/64	9-3/4	#3	TTC	TSC	24015H-003IS060
		Extended	15/16	6-1/2	9-11/32	9-47/64	9-15/32	13-7/32	#3	TTC	TSC	⚠ 25015H-003IS060
m	1	Standard	18	121	149	159.2	157.6	248	#3	TTC	TSC	24010H-003IS045
		Standard	21	121	149	159.2	157.6	248	#3	TTC	TSC	24010H-003IS052
		Extended	18	165	237	247.3	241.3	336	#3	TTC	TSC	⚠ 25010H-003IS045
		Extended	22	165	237	247.3	241.3	336	#3	TTC	TSC	⚠ 25010H-003IS052
	1.5	Standard	22	121	149	159.2	157.6	248	#3	TTC	TSC	24015H-003IS056
		Standard	24	121	149	159.2	157.6	248	#3	TTC	TSC	24015H-003IS060
	Extended	24	165	237	247.3	234.5	336	#3	TTC	TSC	⚠ 25015H-003IS060	

*If using Structural Steel holder with Notch Point®, GEN2 T-A, or 150° Structural Steel T-A drill insert geometry

Helical Flute #4 Morse Taper

Series	Length	D ₁	Body					Shank			Part No.	
			L ₂	L ₄	L ₃	L ₃ *	L ₁	MT	P ₁	P ₂		
i	1	Standard	18mm	4-3/4	5-7/8	6-21/64	6-17/64	10-3/4	#4	TTC	TSC	24010H-004IS045
		Standard	13/16	4-3/4	5-7/8	6-21/64	6-17/64	10-3/4	#4	TTC	TSC	24010H-004IS052
		Extended	13/16	6-1/2	9-9/32	9-47/64	9-43/64	14-5/32	#4	TTC	TSC	⚠ 25010H-004IS052
		Long	13/16	6-1/2	15-25/32	16-15/64	16-11/64	20-21/32	#4	TTC	TSC	⚠ 26010H-004IS052
	1.5	Standard	7/8	4-3/4	5-7/8	6-21/64	6-17/64	10-3/4	#4	TTC	TSC	24015H-004IS056
		Standard	15/16	4-3/4	5-7/8	6-21/64	6-17/64	10-3/4	#4	TTC	TSC	24015H-004IS060
	Extended	15/16	6-1/2	9-9/32	9-47/64	9-43/64	14-5/32	#4	TTC	TSC	⚠ 25015H-004IS060	
m	1	Standard	18	121	149	159.2	157.6	248	#4	TTC	TSC	24010H-004IS045
		Standard	21	121	149	159.2	157.6	248	#4	TTC	TSC	24010H-004IS052
		Extended	22	165	237	247.3	241.3	336	#4	TTC	TSC	⚠ 25010H-004IS052
		Long	22	165	237	247.3	241.3	336	#4	TTC	TSC	⚠ 26010H-004IS052
	1.5	Standard	22	121	149	159.2	157.6	248	#4	TTC	TSC	24015H-004IS056
		Standard	24	121	149	159.2	157.6	248	#4	TTC	TSC	24015H-004IS060
	Extended	24	165	237	247.3	234.5	336	#4	TTC	TSC	⚠ 25015H-004IS060	
	Long	24	165	237	247.3	234.5	336	#4	TTC	TSC	⚠ 26015H-004IS060	

*If using Structural Steel holder with Notch Point®, GEN2 T-A, or 150° Structural Steel T-A drill insert geometry

i = Imperial (in)
m = Metric (mm)

Screws sold in multiples of 10

⚠ WARNING Refer to Speed and Feed charts for recommended adjustments to speeds and feeds. Refer to page A91: 35 for deep hole drilling guidelines in this section of the catalog. Visit www.alliedmachine.com/DeepHoleGuidelines for the most up-to-date information and procedures. Factory technical assistance is available for your specific applications through our Application Engineering Team.

A DRILLING
B BORING
C REAMING
D BURNISHING
E THREADING
X SPECIALS



Original T-A® Structural Steel Drill Inserts

2 Series | Diameter Range: 1.0000" - 1.3750" (25.40mm - 34.93mm)



Thin Wall

For material up to 7/16" thick

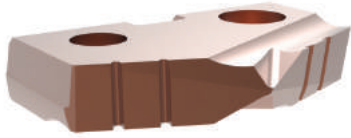
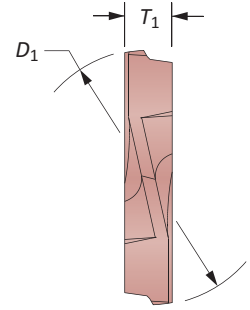
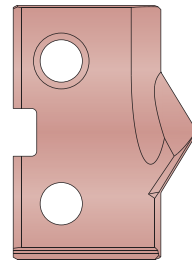

Notch Point®

For material over 7/16" thick

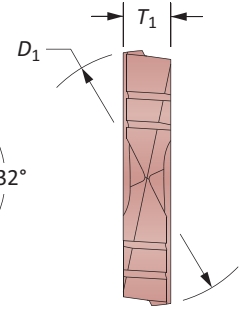
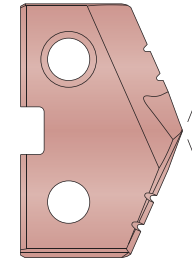

150° Structural Steel

For material over 7/16" thick and for reduced exit burr

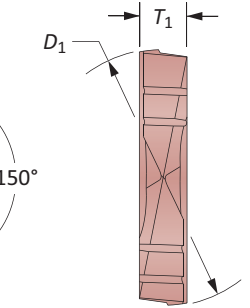
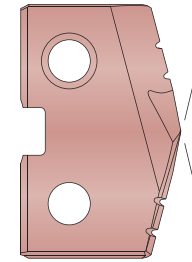

HSS Inserts – Super Cobalt

Series	Insert				Thin Wall		Notch Point		150° Structural Steel	
	Fractional Equivalent	D ₁ inch	D ₁ mm	T ₁	AM200 Part No.	TiAlN Part No.	AM200 Part No.	TiAlN Part No.	AM200 Part No.	TiAlN Part No.
2	1	1.0000	25.40	3/16	152H-0100-TW	152A-0100-TW	152H-0100-NP	152A-0100-NP	152H-0100-SS	152A-0100-SS
	–	1.0236	26.00	3/16	152H-26-TW	152A-26-TW	152H-26-NP	152A-26-NP	152H-26-SS	152A-26-SS
	1-1/16	1.0625	26.99	3/16	152H-0102-TW	152A-0102-TW	152H-0102-NP	152A-0102-NP	152H-0102-SS	152A-0102-SS
	–	1.0630	27.00	3/16	152H-27-TW	152A-27-TW	152H-27-NP	152A-27-NP	152H-27-SS	152A-27-SS
	1-1/8	1.1250	28.58	3/16	152H-0104-TW	152A-0104-TW	152H-0104-NP	152A-0104-NP	152H-0104-SS	152A-0104-SS
2.5	1-3/16	1.1875	30.16	3/16	152H-0106-TW	152A-0106-TW	152H-0106-NP	152A-0106-NP	152H-0106-SS	152A-0106-SS
	–	1.2205	31.00	3/16	152H-31-TW	152A-31-TW	152H-31-NP	152A-31-NP	152H-31-SS	152A-31-SS
	1-1/4	1.2500	31.75	3/16	152H-0108-TW	152A-0108-TW	152H-0108-NP	152A-0108-NP	152H-0108-SS	152A-0108-SS
	–	1.2992	33.00	3/16	152H-33-TW	152A-33-TW	152H-33-NP	152A-33-NP	152H-33-SS	152A-33-SS
	1-5/16	1.3125	33.34	3/16	152H-0110-TW	152A-0110-TW	152H-0110-NP	152A-0110-NP	152H-0110-SS	152A-0110-SS
	–	1.3750	34.93	3/16	152H-0112-TW	152A-0112-TW	152H-0112-NP	152A-0112-NP	152H-0112-SS	152A-0112-SS
	1-3/8	1.3750	34.93	3/16	152H-0112-TW	152A-0112-TW	152H-0112-NP	152A-0112-NP	152H-0112-SS	152A-0112-SS

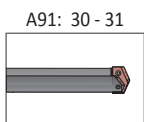
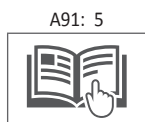
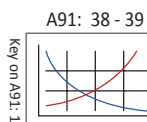

Inserts sold in multiples of 2



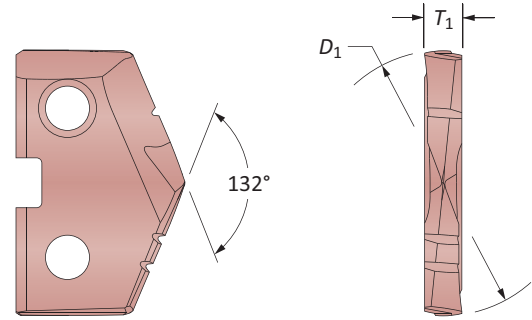

GEN2 T-A® Structural Steel Drill Inserts

2 Series | Diameter Range: 1.0000" - 1.3750" (25.40mm - 34.93mm)



HSS Inserts – Super Cobalt | Carbide Inserts – C1 (K35)

Series	Fractional Equivalent	Insert			Part No.	
		D ₁ inch	D ₁ mm	T ₁	 Super Cobalt	 C1 (K35)
2	1	1.0000	25.40	3/16	452H-0100-HE	4C12H-0100-HE
	–	1.0236	26.00	3/16	452H-26-HE	4C12H-26-HE
	1-1/16	1.0625	26.99	3/16	452H-0102-HE	4C12H-0102-HE
	–	1.0630	27.00	3/16	452H-27-HE	4C12H-27-HE
	1-1/8	1.1250	28.58	3/16	452H-0104-HE	4C12H-0104-HE
2.5	1-3/16	1.1875	30.16	3/16	452H-0106-HE	4C12H-0106-HE
	–	1.2205	31.00	3/16	452H-31-HE	4C12H-31-HE
	1-1/4	1.2500	31.75	3/16	452H-0108-HE	4C12H-0108-HE
	–	1.2992	33.00	3/16	452H-33-HE	4C12H-33-HE
	1-5/16	1.3125	33.34	3/16	452H-0110-HE	4C12H-0110-HE
	1-3/8	1.3750	34.93	3/16	452H-0112-HE	4C12H-0112-HE

Key on A91-1

A91: 38 - 39

A91: 5

A91: 30 - 31

Inserts sold in multiples of 2

T-A® Structural Steel Drill Insert Holders

2 Series | Taper Shank

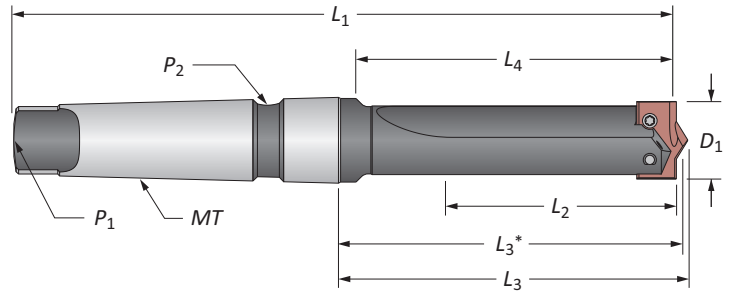

Straight Flute #4 Morse Taper

Series	Length	D ₁	Body					Shank			Part No.	
			L ₂	L ₄	L ₃	L ₃ *	L ₁	MT	P ₁	P ₂		
i	2	Short	1 - 1-3/8	3-3/8	4-1/2	4-63/64	4-57/64	9-3/8	#4	TTC	TSC	22020S-004IS100
	2.5	Short	1-3/16 - 1-3/8	3-3/8	4-1/2	4-63/64	4-57/64	9-3/8	#4	TTC	TSC	22025S-004IS112
m	2	Short	26	86	114	126.6	124.2	238	#4	TTC	TSC	22020S-004IS100
	2.5	Short	31	86	114	126.6	124.2	238	#4	TTC	TSC	22025S-004IS112

*If using Structural Steel holder with Notch Point®, GEN2 T-A, or 150° Structural Steel T-A drill insert geometry

Connection Accessories

Series	Insert Screws	Nylon Locking Screws	Insert Driver	Preset Torque Hand Driver	Replacement Tips	Admissible Tightening Torque*
2	7495-IP15-1	7495N-IP15-1	8IP-15	8IP-15TL	8IP-15B	61.0 in-lbs (690 N-cm)
2.5	7495-IP15-1	7495N-IP15-1	8IP-15	8IP-15TL	8IP-15B	61.0 in-lbs (690 N-cm)

*Tightening torques are calculated with a friction coefficient of $\mu = 0.14$ and develop 90% of ultimate yield strength

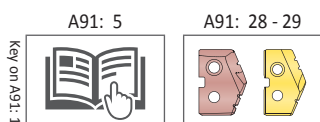

i = Imperial (in)
m = Metric (mm)

Screws sold in multiples of 10



T-A® Structural Steel Drill Insert Holders

2 Series | Taper Shank

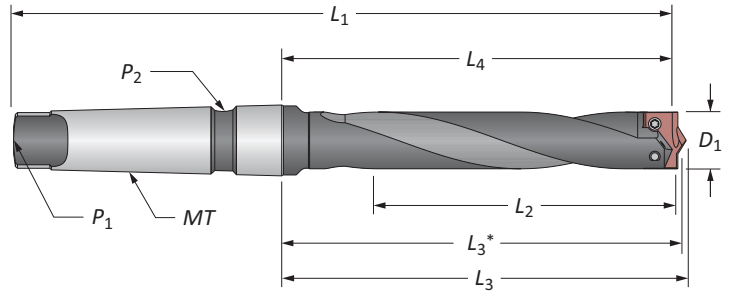

Helical Flute #3 Morse Taper

Series	Length	D ₁	Body					Shank			Part No.
			L ₂	L ₄	L ₃	L ₃ *	L ₁	MT	P ₁	P ₂	
i 2	Extended	1 - 1-3/8	6-1/2	9-11/32	9-3/4	9-29/64	13-7/32	#3	TTC	TSC	⚠ 25020H-003IS100
m 2	Extended	26	165	237	247.7	240.1	336	#3	TTC	TSC	⚠ 25020H-003IS100

*If using Structural Steel holder with Notch Point®, GEN2 T-A, or 150° Structural Steel T-A drill insert geometry

Helical Flute #4 Morse Taper

Series	Length	D ₁	Body					Shank			Part No.
			L ₂	L ₄	L ₃	L ₃ *	L ₁	MT	P ₁	P ₂	
i 2	Standard	1 - 1-3/8	5-3/8	6-1/2	6-63/64	6-57/64	11-3/8	#4	TTC	TSC	24020H-004IS100
	Extended	1 - 1-3/8	6-1/2	9-7/32	9-3/4	9-43/64	15-5/32	#4	TTC	TSC	⚠ 25020H-004IS100
	Long	1 - 1-3/8	6-1/2	16	16-15/32	16-25/64	20-7/8	#4	TTC	TSC	⚠ 26020H-004IS100
i 2.5	Standard	1-3/16 - 1-3/8	5-3/8	6-1/2	6-63/64	6-57/64	11-3/8	#4	TTC	TSC	24025H-004IS112
m 2	Standard	26	137	165	177.4	175.0	289	#4	TTC	TSC	24020H-004IS100
	Extended	26	165	237	247.7	240.1	336	#4	TTC	TSC	⚠ 25020H-004IS100
	Long	26	165	406	418.3	416.3	530	#4	TTC	TSC	⚠ 26020H-004IS100
	Standard	31	137	165	177.4	175.0	289	#4	TTC	TSC	24025H-004IS112

*If using Structural Steel holder with Notch Point®, GEN2 T-A, or 150° Structural Steel T-A drill insert geometry

i = Imperial (in)
m = Metric (mm)

Screws sold in multiples of 10

⚠ WARNING Refer to Speed and Feed charts for recommended adjustments to speeds and feeds. Refer to page A91: 35 for deep hole drilling guidelines in this section of the catalog. Visit www.alliedmachine.com/DeepHoleGuidelines for the most up-to-date information and procedures. Factory technical assistance is available for your specific applications through our Application Engineering Team.

3

DRILLING | Structural Steel Replaceable Insert Drilling System

Original T-A® Structural Steel Drill Inserts

3 Series | Diameter Range: 1.4375" - 1.5625" (36.51mm - 39.69mm)

Thin Wall

For material up to 7/16" thick







Notch Point®

For material over 7/16" thick

150° Structural Steel

For material over 7/16" thick and for reduced exit burr

HSS Inserts – Super Cobalt

Insert				Thin Wall		Notch Point		150° Structural Steel	
Fractional Equivalent	D_1 inch	D_1 mm	T_1						
				AM200 Part No.	TiAlN Part No.	AM200 Part No.	TiAlN Part No.	AM200 Part No.	TiAlN Part No.
1-7/16	1.4375	36.51	1/4	153H-0114-TW	153A-0114-TW	153H-0114-NP	153A-0114-NP	153H-0114-SS	153A-0114-SS
1-1/2	1.5000	38.10	1/4	153H-0116-TW	153A-0116-TW	153H-0116-NP	153A-0116-NP	153H-0116-SS	153A-0116-SS
-	1.5354	39.00	1/4	153H-39-TW	153A-39-TW	153H-39-NP	153A-39-NP	153H-39-SS	153A-39-SS
1-9/16	1.5625	39.69	1/4	153H-0118-TW	153A-0118-TW	153H-0118-NP	153A-0118-NP	153H-0118-SS	153A-0118-SS

B

BORING

C

REAMING

D

BURNISHING

E

THREADING

X

SPECIALS

Key on A91: 1

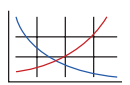
A91: 38 - 39 

A91: 5 

A91: 34 

Inserts sold in multiples of 1

A91: 32

www.alliedmachine.com | 1.330.343.4283



GEN2 T-A® Structural Steel Drill Inserts

3 Series | Diameter Range: 1.4375" - 1.5625" (36.51mm - 39.69mm)

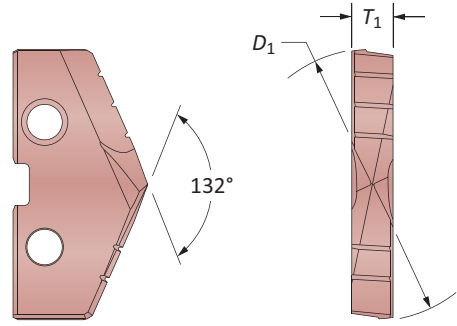
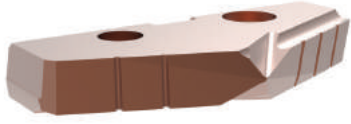

HSS Inserts – Super Cobalt

Fractional Equivalent	Insert			Part No.
	D_1 inch	D_1 mm	T_1	Super Cobalt
1-7/16	1.4375	36.51	1/4	453H-0114-HE
1-1/2	1.5000	38.10	1/4	453H-0116-HE
-	1.5354	39.00	1/4	453H-39-HE
1-9/16	1.5625	39.69	1/4	453H-0118-HE

Key on A91-1

A91: 38 - 39

A91: 5

A91: 34

Inserts sold in multiples of 1

T-A® Structural Steel Drill Insert Holders

3 Series | Taper Shank

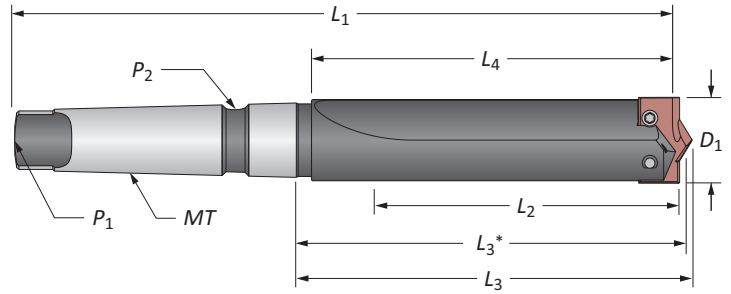

Straight Flute #4 Morse Taper

Length	D_1	Body					Shank			Part No.
		L_2	L_4	L_3	L_3^*	L_1	MT	P_1	P_2	
① Short	1-13/32 - 1-7/8	4-3/4	6	6-1/2	6-7/16	10-7/8	#4	TTC	TSC	22030S-004IS126

*If using Structural Steel holder with Notch Point®, GEN2 T-A, or 150° Structural Steel T-A drill insert geometry

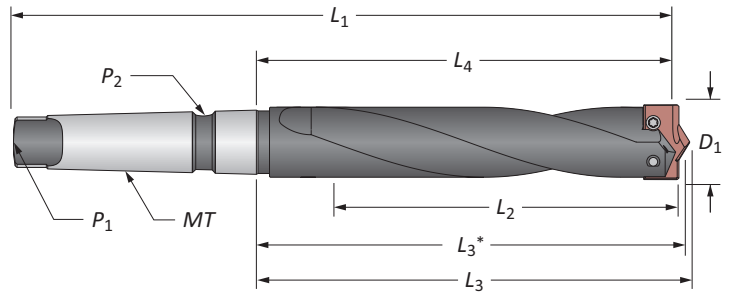

Helical Flute #4 Morse Taper

Length	D_1	Body					Shank			Part No.
		L_2	L_4	L_3	L_3^*	L_1	MT	P_1	P_2	
① Standard	1-13/32 - 1-7/8	6-1/2	7-3/4	8-1/4	8-3/16	12-5/8	#4	TTC	TSC	24030H-004IS126

*If using Structural Steel holder with Notch Point®, GEN2 T-A, or 150° Structural Steel T-A drill insert geometry

Connection Accessories

Insert Screws	Nylon Locking Screws	Insert Driver	Preset Torque Hand Driver	Replacement Tips	Admissible Tightening Torque*
7514-IP20-1	7514N-IP20-1	8IP-20	-	-	121.3 in-lbs (1370 N-cm)

*Tightening torques are calculated with a friction coefficient of $\mu = 0.14$ and develop 90% of ultimate yield strength

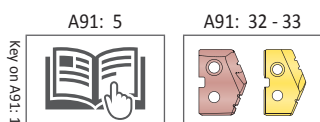

A91: 34





www.alliedmachine.com | 1.330.343.4283

① = Imperial (in)
 Ⓜ = Metric (mm)

Screws sold in multiples of 10

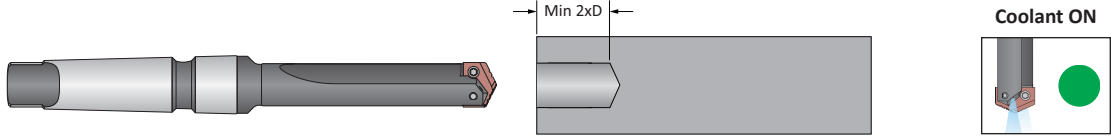
Deep Hole Drilling Guidelines

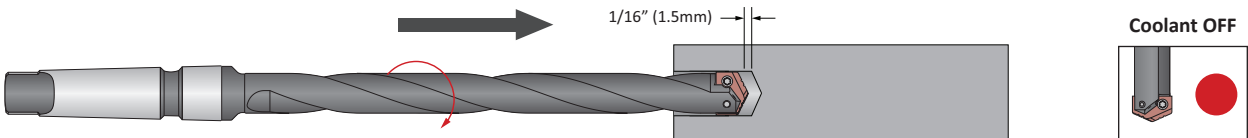
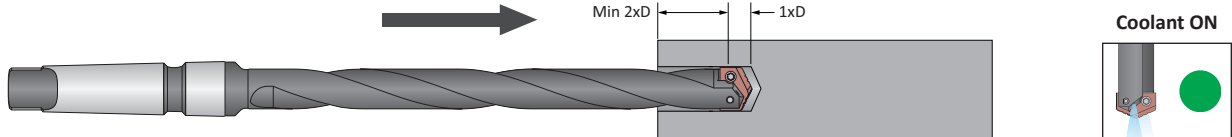
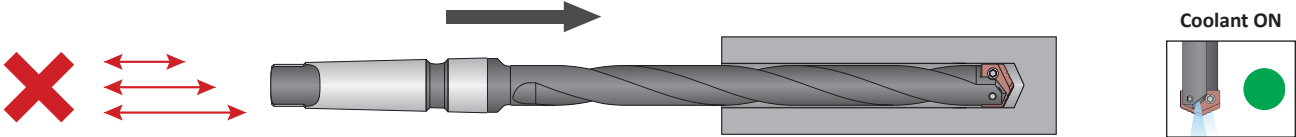
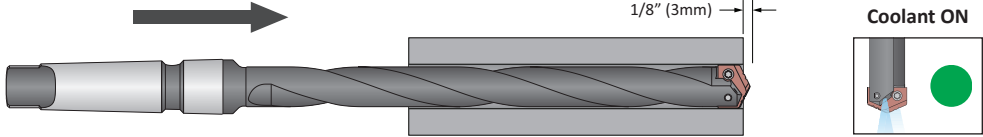
For Use with Drills Greater than 9xD (Extended, Long, XL, 3XL, and Special Length)

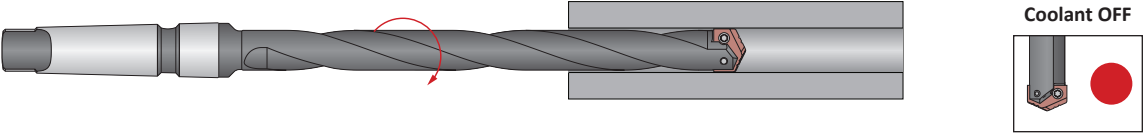
<p>1. Pilot Hole 100 % RPM 100% IPR (mm/rev)</p>	<p>Establish the pilot hole using the same diameter short drill to a depth of 2xD minimum. Utilize a pilot drill with the same or larger included point angle.</p>	
<p> 2. Feed-in 50 RPM max 12 IPM (300 mm/min)</p>	<p>Feed the longer drill within 1/16" (1.5mm) short of the established pilot hole bottom at a maximum of 50 RPM and 12 IPM (300 mm/min) feed rate.</p>	
<p>3. Deep Hole Transition Drilling 50 % RPM 75% IPR (mm/rev)</p>	<p>Drill additional 1xD past the bottom of the pilot hole at 50% reduction of recommended speed and 25% reduction of recommended feed. Minimum of 1 second dwell is required to meet full speed before feeding.</p>	
<p>4. Deep Hole Drilling - Blind 100% RPM 100% IPR (mm/rev)</p>	<p>Drill to full depth at recommended speed and feed for longer drill according to Allied speed and feed charts. No peck cycle recommended.</p>	
<p>5. Deep Hole Drilling - at Breakout 50% RPM 75% IPR (mm/rev)</p>	<p>For through holes only: Reduce speed by 50% and feed by 25% prior to breakout. Do not break out more than 1/8" (3mm) past the full diameter of the drill.</p>	
<p> 6. Drill Retract 50 RPM max</p>	<p>Reduce speed to a maximum of 50 RPM before retracting from the hole.</p>	

⚠ WARNING Tool failure can cause serious injury. To prevent:

- When using holders without support bushing, use a short T-A® holder to establish an initial hole that is a minimum of 2 diameters deep.
- Do not rotate tool holders more than 50 RPM unless it is engaged with the workpiece or fixture.

Visit www.alliedmachine.com/DeepHoleGuidelines for the most up-to-date information and procedures. Factory technical assistance is available for your specific applications through our Application Engineering Team.

A
DRILLING
B
BORING
C
REAMING
D
BURNISHING
E
THREADING
X
SPECIALS

Recommended Cutting Data

GEN3SYS® XT



Imperial (inch)

ISO	Material	Speed (SFM) - Mist Coolant		Feed Rate (IPR) by Diameter			
		Hardness (BHN)	AM300 Speed	12 series 0.4724 - 0.5117	14 series 0.5512 - 0.5905	15 series 0.5906 - 0.6298	16 series 0.6299 - 0.6692
P	Structural Steel A36, A285, A516, A572, etc.	100 - 150	350	0.008	0.010	0.010	0.012
		150 - 250	300	0.007	0.009	0.009	0.010
		250 - 350	260	0.006	0.008	0.008	0.009

Metric (mm)

ISO	Material	Speed (M/mm) - Mist Coolant		Feed Rate (mm/rev) by Diameter			
		Hardness (BHN)	AM300 Speed	12 series 12.00 - 12.99	14 series 14.00 - 14.99	15 series 15.00 - 15.99	16 series 16.00 - 16.99
P	Structural Steel A36, A285, A516, A572, etc.	100 - 150	107	0.20	0.25	0.25	0.30
		150 - 250	91	0.18	0.23	0.23	0.25
		250 - 350	79	0.15	0.20	0.20	0.23

Speed and Feed Multiplier

	Depth of Cut	
	<= 1.5xD	> 1.5xD
Speed	See above chart	0.75
Feed	See above chart	0.90

NOTE: The speeds and feeds listed above are based on a rigid setup using air mist through tool coolant. Speed may be increased up to 50% if using high pressure flood or through coolant.

NOTE: If drilling dry without coolant, speed must be reduced significantly based on setup, drill depth, and material hardness. Up to 50% speed and feed reduction may be necessary in these types of applications. Contact the Application Engineering department for assistance.

NOTE: If drilling material thickness of 0.500" (12.7mm) or less, a minimum of 10% reduction in feed is required to minimize material deflection.

Feed Rate (IPR) by Diameter

17 series 0.6693 - 0.7086	18 series 0.7087 - 0.7873	20 series 0.7874 - 0.8660	22 series 0.8661 - 0.9448	24 series 0.9449 - 1.0235	26 series 1.0236 - 1.1416	29 series 1.1417 - 1.2597	32 series 1.2598 - 1.3780
0.012	0.014	0.015	0.016	0.017	0.018	0.019	0.019
0.010	0.012	0.014	0.015	0.016	0.017	0.018	0.018
0.009	0.011	0.012	0.013	0.014	0.015	0.016	0.016

Feed Rate (mm/rev) by Diameter



17 series 17.00 - 17.99	18 series 18.00 - 19.99	20 series 20.00 - 21.99	22 series 22.00 - 23.99	24 series 24.00 - 25.99	26 series 26.00 - 28.99	29 series 29.00 - 31.99	32 series 32.00 - 35.00
0.30	0.36	0.38	0.41	0.43	0.46	0.48	0.48
0.25	0.30	0.36	0.38	0.41	0.43	0.46	0.46
0.23	0.28	0.30	0.33	0.36	0.38	0.41	0.41

Recommended Cutting Data | Imperial (inch)

Original T-A® | GEN2 T-A®





Thin Wall Inserts Super Cobalt

ISO	Material	Speed (SFM) - Mist Coolant		Feed Rate (IPR) by Diameter				
		Hardness (BHN)	 AM200 Speed	 TiAlN Speed	0 series 9/16 - 11/16	1 series 13/16 - 15/16	2 series 1 - 1-3/8	3 series 1-13/32 - 1-7/8
P	Structural Steel A36, A285, A516, etc.	100 - 150	125	110	0.012	0.018	0.019	0.020
		150 - 250	115	100	0.011	0.016	0.017	0.019
		250 - 350	105	90	0.010	0.014	0.016	0.018



Notch Point® and 150° Structural Steel Inserts Super Cobalt

ISO	Material	Speed (SFM) - Mist Coolant		Feed Rate (IPR) by Diameter				
		Hardness (BHN)	 AM200 Speed	 TiAlN Speed	0 series 9/16 - 11/16	1 series 13/16 - 15/16	2 series 1 - 1-3/8	3 series 1-13/32 - 1-7/8
P	Structural Steel A36, A285, A516, etc.	100 - 150	125	110	0.010	0.012	0.014	0.018
		150 - 250	115	100	0.009	0.011	0.012	0.016
		250 - 350	105	90	0.008	0.010	0.011	0.014

GEN2 T-A Inserts Super Cobalt



ISO	Material	Speed (SFM) - Mist Coolant		Feed Rate (IPR) by Diameter			
		Hardness (BHN)	 AM200 Speed	0 series 9/16 - 11/16	1 series 13/16 - 15/16	2 series 1 - 1-3/8	3 series 1-13/32 - 1-7/8
P	Structural Steel A36, A285, A516, etc.	100 - 150	125	0.010	0.012	0.014	0.018
		150 - 250	115	0.009	0.011	0.012	0.016
		250 - 350	105	0.008	0.010	0.011	0.014

GEN2 T-A Inserts Carbide C1 (K35)

ISO	Material	Speed (SFM) - Mist Coolant		Feed Rate (IPR) by Diameter			
		Hardness (BHN)	 AM200 Speed	0 series 9/16 - 11/16	1 series 13/16 - 15/16	2 series 1 - 1-3/8	3 series 1-13/32 - 1-7/8
P	Structural Steel A36, A285, A516, etc.	100 - 150	165	0.008	0.011	0.015	0.017
		150 - 250	155	0.006	0.010	0.013	0.015
		250 - 350	140	0.005	0.009	0.012	0.013



NOTE: The speeds and feeds listed above are based on a rigid setup using air mist through tool coolant. Speed may be increased up to 50% if using high pressure flood or through coolant.
NOTE: If drilling dry without coolant, speed must be reduced significantly based on setup, drill depth, and material hardness. Up to 50% speed and feed reduction may be necessary in these types of applications. Contact the Application Engineering department for assistance.

Recommended Cutting Data | Metric (mm)

Original T-A® | GEN2 T-A®





Thin Wall Inserts Super Cobalt

ISO	Material	Speed (M/mm) - Mist Coolant			Feed Rate (mm/rev) by Diameter			
		Hardness (BHN)	 AM200 Speed	 TiAlN Speed	0 series 14 - 16	1 series 18 - 24	2 series 25 - 35	3 series 36 - 47
P	Structural Steel A36, A285, A516, etc.	100 - 150	39	34	0.30	0.45	0.48	0.50
		150 - 250	35	31	0.28	0.40	0.43	0.48
		250 - 350	32	28	0.25	0.36	0.40	0.45



Notch Point® and 150° Structural Steel Inserts Super Cobalt

ISO	Material	Speed (M/mm) - Mist Coolant			Feed Rate (mm/rev) by Diameter			
		Hardness (BHN)	 AM200 Speed	 TiAlN Speed	0 series 14 - 16	1 series 18 - 24	2 series 25 - 35	3 series 36 - 47
P	Structural Steel A36, A285, A516, etc.	100 - 150	39	34	0.25	0.30	0.36	0.45
		150 - 250	35	31	0.23	0.28	0.30	0.40
		250 - 350	35	28	0.20	0.25	0.28	0.36



GEN2 T-A Inserts Super Cobalt

ISO	Material	Speed (M/mm) - Mist Coolant		Feed Rate (mm/rev) by Diameter			
		Hardness (BHN)	 AM200 Speed	0 series 14 - 16	1 series 18 - 24	2 series 25 - 35	3 series 36 - 47
P	Structural Steel A36, A285, A516, etc.	100 - 150	39	0.25	0.30	0.36	0.46
		150 - 250	35	0.23	0.28	0.30	0.40
		250 - 350	35	0.20	0.25	0.28	0.36

GEN2 T-A Inserts Carbide C1 (K35)

ISO	Material	Speed (M/mm) - Mist Coolant		Feed Rate (mm/rev) by Diameter			
		Hardness (BHN)	 AM200 Speed	0 series 14 - 16	1 series 18 - 24	2 series 25 - 35	3 series 36 - 47
P	Structural Steel A36, A285, A516, etc.	100 - 150	50	0.20	0.28	0.38	0.43
		150 - 250	47	0.15	0.25	0.33	0.38
		250 - 350	43	0.13	0.23	0.30	0.33

NOTE: The speeds and feeds listed above are based on a rigid setup using air mist through tool coolant. Speed may be increased up to 50% if using high pressure flood or through coolant.
NOTE: If drilling dry without coolant, speed must be reduced significantly based on setup, drill depth, and material hardness. Up to 50% speed and feed reduction may be necessary in these types of applications. Contact the Application Engineering department for assistance.

AccuPort 432®

Replaceable Insert Port Contour Cutters | J1926 | ISO6149 | AS5202 | JDG173.1



High Performance Multi-Step Action

Durable and precise, the AccuPort 432 holders provide a strong and rigid platform for the drilling of hydraulic ports. The precision ground insert location on each holder ensures total repeatability and simple, uncomplicated changing of the replaceable inserts.

With the AccuPort technology, you can drill and finish port forms in **ONE** operation. Save time and money with AccuPort.

Single operation hydraulic port cutting system	No pre-drilling required	Replaceable inserts eliminate regrinding and resetting
--	--------------------------	--

Applicable Industries



Your safety and the safety of others is very important. This catalog contains important safety messages. Always read and follow all safety precautions.



This triangle is a safety hazard symbol. It alerts you to potential safety hazards that can cause tool failure and serious injury.

When you see this symbol in the catalog, look for a related safety message that may be near this triangle or referred to in the nearby text.

There are safety signal words also used in the catalog. Safety messages follow these words.

WARNING

WARNING (shown above) means that failure to follow the precautions in this message could result in tool failure and serious injury.

NOTICE means that failure to follow the precautions in this message could result in damage to the tool or machine but not result in personal injury.

NOTE and **IMPORTANT** are also used. These are important that you read and follow but are not safety-related.

Visit www.alliedmachine.com for the most up-to-date information and procedures.

Reference Icons

The following icons will appear throughout the catalog to help you navigate between products.



Setup / Assembly Information

Detailed instructions and information regarding the corresponding part(s)

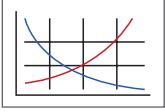

Recommended Cutting Data

Speed and feed recommendations for optimum and safe drilling

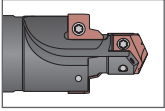

Accuport 432 Holders

Refers to the full details of the holder items included in each kit



Port and Thread Finishing Kits

Lists the available kits complete with AccuPort tool and AccuThread™ solid carbide thread mill

Introduction Information

Product Overview 2 - 4
 Product Nomenclature 5

Port Specifications

SAE J-1926 / ISO 11926-1 / MS-16142 6 - 11
 ISO 6149-1:2006 / SAE J-2244/1 12 - 13
 SAE AS5202 / AND10050 14 - 15
 JDS-G173.1 16 - 17

Port and Thread Finishing Kits

SAE J-1926 / ISO 11926-1 / MS-16142 18 - 21
 ISO 6149-1:2006 / SAE J-2244/1 22 - 25
 SAE AS5202 / AND10050 26 - 27
 JDS-G173.1 28

Recommended Cutting Data (Imperial)

Imperial (inch)	[HSS 30 - 31
		Carbide 32 - 33
Metric (mm)	[HSS 34 - 35
		Carbide 36 - 37

Product Overview

A DRILLING
B BORING
C REAMING
D BURNISHING
E THREADING
X SPECIALS

ONE TOOL | FOUR OPERATIONS

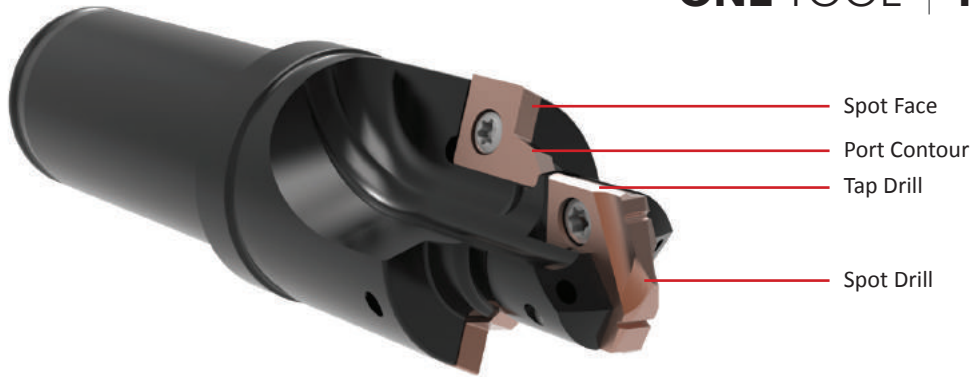





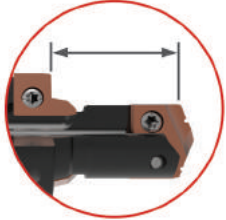

Advanced Solutions, Outstanding Results

As designers and manufacturing engineers push the limits of production technology to improve productivity and performance, Allied Machine has continued to innovate and develop new solutions like the unique AccuPort 432 hydraulic port contour cutter system. Every product in the AccuPort system is designed to deliver maximum performance in a diverse range of hydraulic port cutting applications and demanding manufacturing environments.

Using precision replaceable inserts for both the drilling and port forming operations, AccuPort eliminates the need for tool regrinding and enables absolute repeatability, excellent surface finish, and reduced cost-per-hole. The AccuPort drills, forms, and precision-finishes the hydraulic port in **one** pass. This replaces up to three separate cutting operations in a single tool to deliver outstanding improvements in productivity, accuracy, and repeatability.

Hydraulic systems are present in an incredibly diverse range of industries. Anywhere a hydraulic port is required, AccuPort can provide a more cost effective and higher performance solution in a fraction of the time taken for traditional methods using separate drills, special forming tools, and spot facers.

Port Specification	Notes
<p>Imperial SAE J-1926 ISO 11926-1 MS-16142</p> 	<p>Extended minor diameter length option also available</p> 
<p>Metric ISO 6149-1:2006 SAE J-2244/1</p> 	<p>Holders made with ID ridge Utilizes inserts with or without ID ridge</p>  ID ridge  No ID ridge 
<p>John Deere JDS-G173.1</p> 	<p>Adheres to John Deere port standards</p>
<p>Military SAE AS5202</p> 	<p>Also conforms to AND10050 specification by using an alternate tap drill size for a UN thread</p>



Choosing the Right System

Every product in the AccuPort 432 product line is designed to deliver maximum performance in a diverse range of hydraulic port cutting applications and demanding manufacturing environments. The innovative design delivers the best possible range of benefits in terms of productivity, cost-per-hole, and tool life.

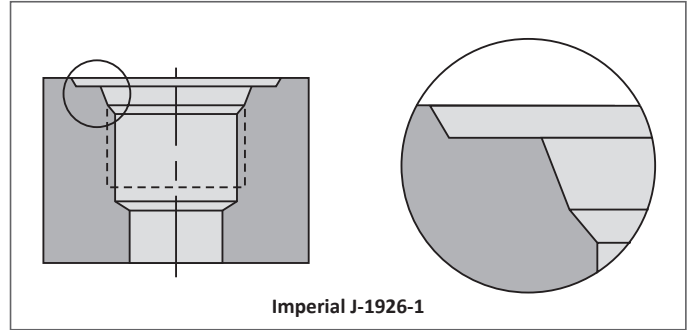

Imperial J-1926-1

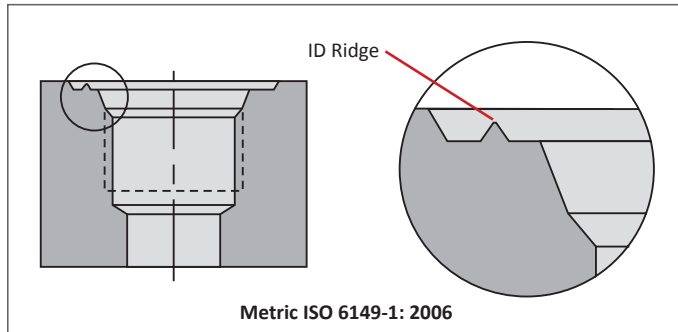

Metric ISO 6149-1: 2006

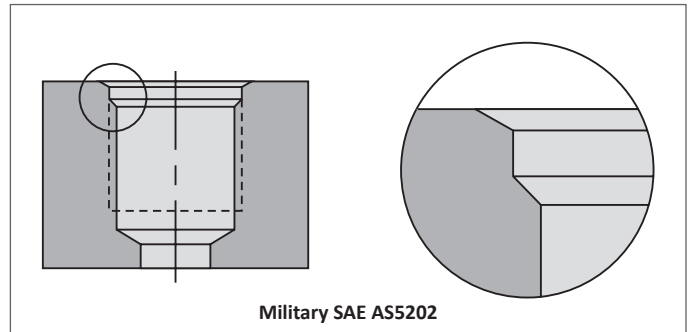

Military SAE AS5202

Common Industry Sectors and Components



Aerospace
Pumps
Landing Gear
Brake Cylinders
Manifolds



Agriculture
Pumps
Manifolds
Cylinders and Rams
Gear Pumps



Automotive
Motor Valves
Relief Valves
Brake Cylinders
Power Steering Pumps



Marine / Shipbuilding
Pumps
Cylinders and Rams
Motors
Manifolds

The Complete Package

Producing fully finished threaded hydraulic ports has never been easier. The Port and Thread Finishing Kit includes the AccuPort 432 contour cutter with a dedicated AccuThread™ solid carbide threadmill in a single kit. You also receive the T-A® inserts and port form inserts needed to complete the assembly.

Port kits incorporate the AccuThread solid carbide threadmills to increase the manufacturing flexibility by allowing hydraulic ports to be produced in just two operations. In addition, where a unique port profile is required, Allied Machine provides a dedicated special tooling solution using our extensive tool design and manufacturing experience to meet precise specifications.

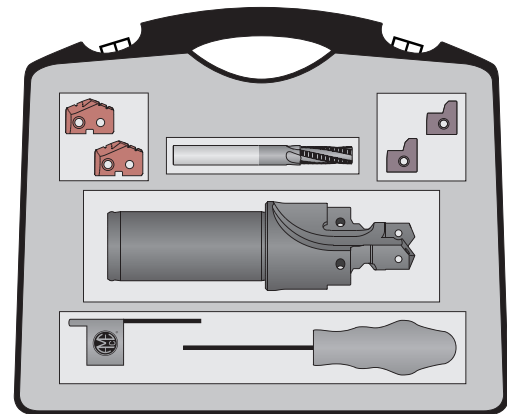

Replaceable Inserts Overview

T-A® Drill Insert Grades			
HSS Super Cobalt (Original T-A® / GEN2 T-A®)	Carbide C5 (P40) (Original T-A® only)	Carbide C1 (K10) (GEN2 T-A® only)	Carbide C3 (K35) (Original T-A® only)
Suited for good to rigid machining applications, used for drilling exotic and high alloy materials, or general use when surface speed needs to be increased for use in material hardness up to 350 BHN 121kg.	Excellent for drilling free machining steel, low/medium carbon steels, alloy steels, high strength steels, tool steels, and hardened steels.	Excellent for drilling free machining steel, low/medium carbon steels, alloy steels, high strength steels, tool steels, and hardened steels.	Designed for drilling grey/white cast irons. The special geometry offers substantial increases in penetration rates and provides exceptional edge strength and tool life.

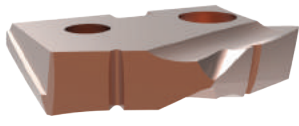
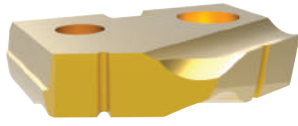
Port Form Inserts	GEN2 T-A Inserts	Original T-A Inserts
 <p>AM200® TiAlN</p>	 <p>AM200®</p>	 <p>TiN</p>

GEN2 T-A Standard Geometry

- Designed for rigid machining applications, primarily used for drilling exotic and high alloy materials
- Ideal for general use when the surface speed needs to be increased



Original T-A Standard Geometry

- First choice for machining aluminum
- Enhanced geometry improves chip formation and hole quality
- TiN coating improves heat resistance and extends tool life

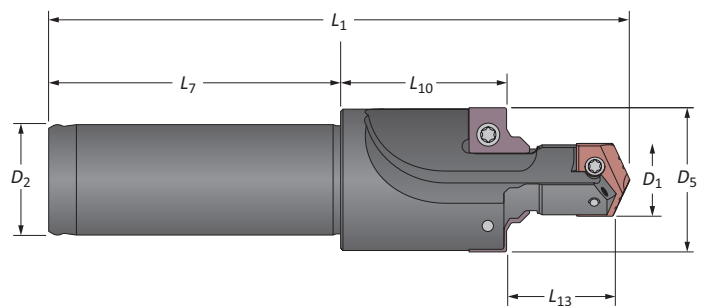
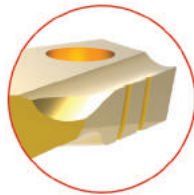

Made-to-Order Tool Specifications

Scan and email a copy of the table below to Allied's Application Engineering Department to receive pricing for a made-to-order AccuPort 432 Port Contour Cutter.

Send emails to appeng@alliedmachine.com

Tube Dash No.	Specification	Port Thread Size	D ₁	L ₁₃	D ₅	L ₁₀	L ₁	D ₂	L ₇
	<input type="checkbox"/> J1926 <input type="checkbox"/> ISO 6149 <input type="checkbox"/> ISO 6149 (no ridge) <input type="checkbox"/> JDS-G173.1 <input type="checkbox"/> AS5202								

Company Name

Contact Name

Phone

Distributor Name

Fax



Product Nomenclature

AccuPort 432 Holders

J1926	-	04	Y	-	063F
1		2	3		4

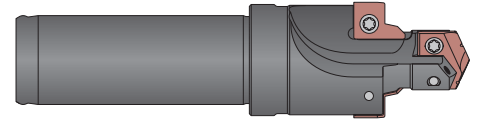

1. Port Specifications	2. Port Tube Dash No.	3. T-A® Insert Series	4. Shank Configuration												
J1926 = Imperial - J1926-1 X1926 = Imperial - J1926-1 (extended minor length) I6149 = Metric (ISO) - 6149-1 G1731 = John Deere - G173.1 AS5202 = Military - AS5202	04 14 05 16 06 18 08 20 10 24 12 32	Y = Y series Z = Z series 0 = 0 series 1 = 1 series 2 = 2 series 3 = 3 series 4 = 4 series	<table border="0"> <tr> <th>Imperial</th> <th>Metric</th> </tr> <tr> <td>063F = 5/8" flanged</td> <td>16FM = 16mm flanged</td> </tr> <tr> <td>075F = 3/4" flanged</td> <td>20FM = 20mm flanged</td> </tr> <tr> <td>100F = 1" flanged</td> <td>25FM = 25mm flanged</td> </tr> <tr> <td>125F = 1-1/4" flanged</td> <td>32FM = 32mm flanged</td> </tr> <tr> <td>150F = 1-1/2" flanged</td> <td></td> </tr> </table>	Imperial	Metric	063F = 5/8" flanged	16FM = 16mm flanged	075F = 3/4" flanged	20FM = 20mm flanged	100F = 1" flanged	25FM = 25mm flanged	125F = 1-1/4" flanged	32FM = 32mm flanged	150F = 1-1/2" flanged	
Imperial	Metric														
063F = 5/8" flanged	16FM = 16mm flanged														
075F = 3/4" flanged	20FM = 20mm flanged														
100F = 1" flanged	25FM = 25mm flanged														
125F = 1-1/4" flanged	32FM = 32mm flanged														
150F = 1-1/2" flanged															

AccuPort 432 Port Form Inserts

J1926	-	02	R	-	C5	A
1		2	3		4	5

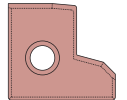

1. Port Specifications	2. Insert Size	3. Port Specifications	4. Substrate	5. Coating
J1926 = Imperial I6149 = Metric (ISO) G1731 = John Deere AS5202 = Military	02 10 03 11 04 12 05 14 06 16 07 20 08 24 09 32	Blank = No ID ridge R = ID ridge	C5 = C5 carbide C3 = C3 carbide	A = TiAlN H = AM200®

Reference Key

Symbol	Attribute
A₁	Seal angle
D₁	Minor diameter
D₂	Shank diameter
D₃	Pilot diameter
D₄	Seal angle diameter
D₅	Spot face diameter
L₁	Overall length
L₇	Shank length
L₁₀	Spot face to shoulder length
L₁₁	Total head length
L₁₂	Seal angle length
L₁₃	Minor diameter length

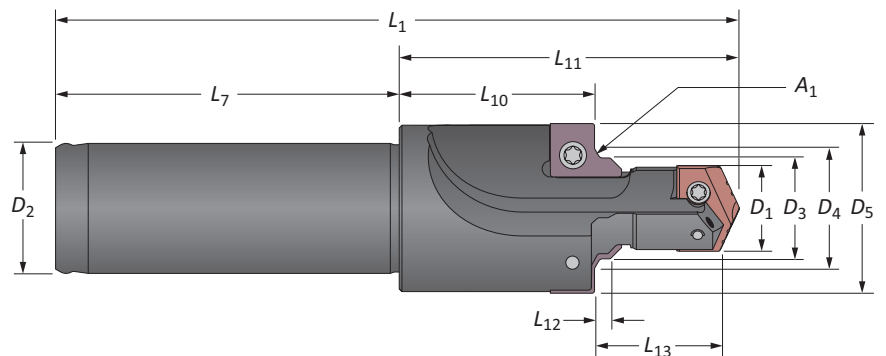

J

 DRILLING | AccuPort 432® Port Contour Cutters

A

SAE J-1926 / ISO 11926-1 / MS-16142

Imperial Shank Holders

DRILLING

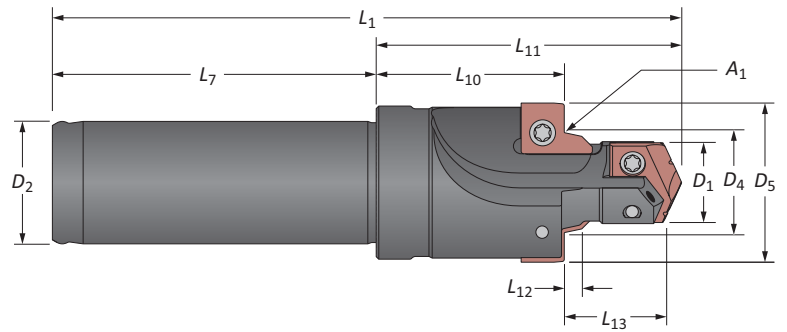
B

BORING

Tube Dash No.	Cutting			Seal Angle			Holder			Shank		Port Thread Size	Part No.
	D_1	L_{13}^*	D_5	A_1	D_4	L_{12}	L_{11}	L_{10}	L_1	L_7	D_2		
-4	0.386	0.551	0.840	12°	0.490	0.106	1.527	0.896	3.402	1.875	0.625	7/16-20 UNF-2B	J1926-04Y-063F
-5	0.453	0.551	0.926	12°	0.553	0.106	1.527	0.885	3.402	1.875	0.625	1/2-20 UNF-2B	J1926-05Z-063F
-6	0.512	0.610	0.989	12°	0.618	0.106	1.857	1.144	3.826	1.969	0.750	9/16-18 UNF-2B	J1926-060-075F
-8	0.689	0.689	1.206	15°	0.813	0.106	1.982	1.150	3.951	1.969	0.750	3/4-16 UNF-2B	J1926-080-075F
-10	0.807	0.787	1.344	15°	0.945	0.106	2.140	1.185	4.421	2.281	1.000	7/8-14 UNF-2B	J1926-101-100F
i -12	0.984	0.906	1.655	15°	1.150	0.138	2.640	1.530	4.921	2.281	1.250	1 1/16-12 UN-2B	J1926-122-125F
-14	1.102	0.906	1.781	15°	1.276	0.138	2.640	1.504	4.921	2.281	1.250	1 3/16-12 UN-2B	J1926-142-125F
-16	1.231	0.906	1.934	15°	1.400	0.138	2.640	1.477	4.921	2.281	1.250	1 5/16-12 UN-2B	J1926-162-125F
-20	1.535	0.906	2.306	15°	1.715	0.138	3.062	1.835	5.750	2.688	1.500	1 5/8-12 UN-2B	J1926-203-150F
-24	1.791	0.906	2.564	15°	1.965	0.138	3.062	1.778	5.750	2.688	1.500	1 7/8-12 UN-2B	J1926-243-150F
-32	2.421	0.906	3.470	15°	2.589	0.138	3.812	2.393	6.500	2.688	1.500	2 1/2-12 UN-2B	J1926-324-150F
m -4	9.80	14.00	21.30	12°	12.50	2.70	38.80	22.80	86.40	47.60	15.90	7/16-20 UNF-2B	J1926-04Y-063F
-5	11.50	14.00	23.50	12°	14.10	2.70	38.80	22.50	86.40	47.60	15.90	1/2-20 UNF-2B	J1926-05Z-063F
-6	13.00	15.50	25.10	12°	15.70	2.70	47.20	29.00	97.20	50.00	19.10	9/16-18 UNF-2B	J1926-060-075F
-8	17.50	17.50	30.60	15°	20.70	2.70	50.30	29.20	100.40	50.00	19.10	3/4-16 UNF-2B	J1926-080-075F
-10	20.50	20.00	34.10	15°	24.00	2.70	54.40	30.10	112.30	57.90	25.40	7/8-14 UNF-2B	J1926-101-100F
m -12	25.00	23.00	42.00	15°	29.20	3.50	67.10	38.90	125.00	57.90	31.80	1 1/16-12 UN-2B	J1926-122-125F
-14	28.00	23.00	45.20	15°	32.40	3.50	67.10	38.20	125.00	57.90	31.80	1 3/16-12 UN-2B	J1926-142-125F
-16	31.20	23.00	49.10	15°	35.60	3.50	67.10	37.50	125.00	57.90	31.80	1 5/16-12 UN-2B	J1926-162-125F
-20	39.00	23.00	58.50	15°	43.60	3.50	77.80	46.60	146.00	68.30	38.10	1 5/8-12 UN-2B	J1926-203-150F
-24	45.50	23.00	65.10	15°	49.90	3.50	77.80	45.20	146.00	68.30	38.10	1 7/8-12 UN-2B	J1926-243-150F
-32	61.50	23.00	88.10	15°	65.80	3.50	96.80	60.80	165.10	68.30	38.10	2 1/2-12 UN-2B	J1926-324-150F

*Port contour cutters are available with extended pilot length (L_{13}). See pages A92: 10-11 for items.

F

THREADING

X

SPECIALS

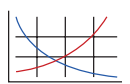
A92: 30 - 37  Key on A92: 1

A92: 2 - 4 

A92: 18 - 21 

i = Imperial (in)
m = Metric (mm)

A92: 6

www.alliedmachine.com | 1.330.343.4283



SAE J-1926 / ISO 11926-1 / MS-16142

Inserts

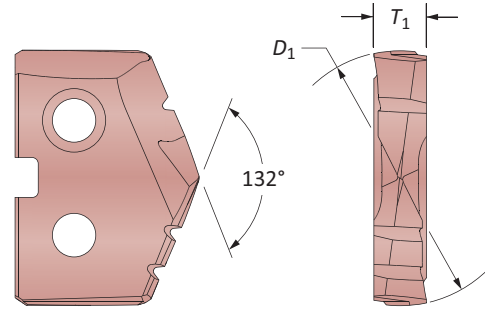

See section A3 for complete T-A insert details

Original T-A® / GEN2 T-A® Drill Inserts

Tube Dash No.	AccuPort Part No.	T-A® Insert Series	Part No.		Insert Screw	Insert Driver	Admissible Tightening Torque*
			Super Cobalt	Carbide			
-4	J1926-04Y-063F	Y	45YH-.386	4C1YH-.386	724-IP7-1	8IP-7	7.4 in/lbs (84 N-cm)
-5	J1926-05Z-063F	Z	45ZH-11.5	4C1ZH-11.5	7247-IP7-1	8IP-7	7.4 in/lbs (84 N-cm)
-6	J1926-060-075F	0	450H-13	4C10H-13	72556-IP8-1	8IP-8	15.5 in/lbs (175 N-cm)
-8	J1926-080-075F	0	450H-0022	4C10H-0022	72567-IP8-1	8IP-8	15.5 in/lbs (175 N-cm)
-10	J1926-101-100F	1	451H-20.5	4C11H-20.5	7375-IP9-1	8IP-9	27.0 in/lbs (305 N-cm)
-12	J1926-122-125F	2	452H-25	4C12H-25	7495-IP15-1	8IP-15	61.0 in/lbs (690 N-cm)
-14	J1926-142-125F	2	452H-28	4C12H-28	7495-IP15-1	8IP-15	61.0 in/lbs (690 N-cm)
-16	J1926-162-125F	2	452H-1.231	4C12H-1.231	7495-IP15-1	8IP-15	61.0 in/lbs (690 N-cm)
-20	J1926-203-150F	3	453H-39	1C53A-39	7514-IP20-1	8IP-20	121.3 in/lbs (1370 N-cm)
-24	J1926-243-150F	3	453H-45.5	1C53A-45.5	7514-IP20-1	8IP-20	121.3 in/lbs (1370 N-cm)
-32	J1926-324-150F	4	454H-61.5	-	7514-IP20-1	8IP-20	121.3 in/lbs (1370 N-cm)

*Tightening torques are calculated with a friction coefficient of $\mu = 0.14$ and develop 90% of ultimate yield strength

Port Form Drill Inserts

Tube Dash No.	AccuPort Part No.	Part No.		Insert Screw	Insert Driver	Admissible Tightening Torque*
		C3 Carbide (AM200®)	C5 Carbide (TiAlN)			
-4	J1926-04Y-063F	J1926-02-C3H	J1926-02-C5A	72556-IP8-1	8IP-8	15.5 in/lbs (175 N-cm)
-5	J1926-05Z-063F	J1926-03-C3H	J1926-03-C5A	72556-IP8-1	8IP-8	15.5 in/lbs (175 N-cm)
-6	J1926-060-075F	J1926-03-C3H	J1926-03-C5A	72556-IP8-1	8IP-8	15.5 in/lbs (175 N-cm)
-8	J1926-080-075F	J1926-07-C3H	J1926-07-C5A	72556-IP8-1	8IP-8	15.5 in/lbs (175 N-cm)
-10	J1926-101-100F	J1926-04-C3H	J1926-04-C5A	72556-IP8-1	8IP-8	15.5 in/lbs (175 N-cm)
-12	J1926-122-125F	J1926-08-C3H	J1926-08-C5A	72556-IP8-1	8IP-8	15.5 in/lbs (175 N-cm)
-14	J1926-142-125F	J1926-08-C3H	J1926-08-C5A	72556-IP8-1	8IP-8	15.5 in/lbs (175 N-cm)
-16	J1926-162-125F	J1926-09-C3H	J1926-09-C5A	7375-IP9-1	8IP-9	27.0 in/lbs (305 N-cm)
-20	J1926-203-150F	J1926-10-C3H	J1926-10-C5A	7375-IP9-1	8IP-9	27.0 in/lbs (305 N-cm)
-24	J1926-243-150F	J1926-11-C3H	J1926-11-C5A	7375-IP9-1	8IP-9	27.0 in/lbs (305 N-cm)
-32	J1926-324-150F	J1926-12-C3H	J1926-12-C5A	7375-IP9-1	8IP-9	27.0 in/lbs (305 N-cm)

*Tightening torques are calculated with a friction coefficient of $\mu = 0.14$ and develop 90% of ultimate yield strength

A92: 30 - 37

A92: 2 - 4

A92: 18 - 21

Y - 2 series T-A inserts sold in multiples of 2
 3 - 4 series T-A inserts sold in multiples of 1
 Port form inserts sold in multiples of 2
 Insert screws sold in multiples of 10

A DRILLING
B BORING
C REAMING
D BURNISHING
E THREADING
X SPECIALS

SAE J-1926 / ISO 11926-1 / MS-16142

Metric Shank Holders

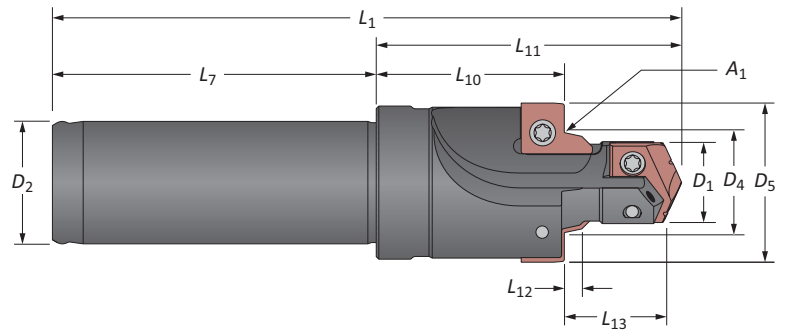

Tube Dash No.	Cutting			Seal Angle			Holder			Shank		Port Thread Size	Part No.
	D_1	L_{13}	D_5	A_1	D_4	L_{12}	L_{11}	L_{10}	L_1	L_7	D_2		
-4	0.386	0.551	0.840	12°	0.490	0.106	1.527	0.896	3.180	1.650	0.630	7/16-20 UNF-2B	J1926-04Y-16FM
-5	0.453	0.551	0.926	12°	0.553	0.106	1.527	0.885	3.650	1.650	0.630	1/2-20 UNF-2B	J1926-05Z-16FM
-6	0.512	0.610	0.989	12°	0.618	0.106	1.857	1.144	3.510	1.650	0.787	9/16-18 UNF-2B	J1926-06O-20FM
-8	0.689	0.689	1.206	15°	0.813	0.106	1.982	1.150	3.630	1.650	0.787	3/4-16 UNF-2B	J1926-08O-20FM
-10	0.807	0.787	1.344	15°	0.945	0.106	2.140	1.185	4.230	2.091	0.984	7/8-14 UNF-2B	J1926-101-25FM
i -12	0.984	0.906	1.655	15°	1.150	0.138	2.640	1.530	4.920	2.280	1.260	1 1/16-12 UN-2B	J1926-122-32FM
-14	1.102	0.906	1.781	15°	1.276	0.138	2.640	1.504	4.920	2.280	1.260	1 3/16-12 UN-2B	J1926-142-32FM
-16	1.231	0.906	1.934	15°	1.400	0.138	2.640	1.477	4.920	2.280	1.260	1 5/16-12 UN-2B	J1926-162-32FM
-20	1.535	0.906	2.306	15°	1.715	0.138	3.062	1.835	5.640	2.580	1.260	1 5/8-12 UN-2B	J1926-203-32FM*
-24	1.791	0.906	2.564	15°	1.965	0.138	3.062	1.778	5.640	2.580	1.260	1 7/8-12 UN-2B	J1926-243-32FM*
-32	2.421	0.906	3.470	15°	2.589	0.138	3.812	2.393	6.390	2.580	1.260	2 1/2-12 UN-2B	J1926-324-32FM*
m -4	9.80	14.00	21.30	12°	12.50	2.70	45.10	22.80	80.70	41.90	16.00	7/16-20 UNF-2B	J1926-04Y-16FM
-5	11.50	14.00	23.50	12°	14.10	2.70	45.10	22.50	92.80	41.90	16.00	1/2-20 UNF-2B	J1926-05Z-16FM
-6	13.00	15.50	25.10	12°	15.70	2.70	47.20	29.00	89.10	41.90	20.00	9/16-18 UNF-2B	J1926-06O-20FM
-8	17.50	17.50	30.60	15°	20.70	2.70	50.30	29.20	92.30	41.90	20.00	3/4-16 UNF-2B	J1926-08O-20FM
-10	20.50	20.00	34.10	15°	24.00	2.70	54.40	30.10	107.40	53.10	25.00	7/8-14 UNF-2B	J1926-101-25FM
m -12	25.00	23.00	42.00	15°	29.20	3.50	67.10	38.90	125.00	57.90	32.00	1 1/16-12 UN-2B	J1926-122-32FM
-14	28.00	23.00	45.20	15°	32.40	3.50	67.10	38.20	125.00	57.90	32.00	1 3/16-12 UN-2B	J1926-142-32FM
-16	31.20	23.00	49.10	15°	35.60	3.50	67.10	37.50	125.00	57.90	32.00	1 5/16-12 UN-2B	J1926-162-32FM
-20	39.00	23.00	58.50	15°	43.60	3.50	77.80	46.60	143.30	65.50	32.00	1 5/8-12 UN-2B	J1926-203-32FM*
-24	45.50	23.00	65.10	15°	49.90	3.50	77.80	45.20	143.30	65.50	32.00	1 7/8-12 UN-2B	J1926-243-32FM*
-32	61.50	23.00	88.10	15°	65.80	3.50	96.80	60.80	162.30	65.50	32.00	2 1/2-12 UN-2B	J1926-324-32FM*

*NOTICE: Due to the cutting forces generated by this tool, a mechanical chuck is required. Please contact Application Engineering with any questions.

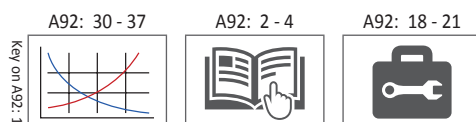

i = Imperial (in)
m = Metric (mm)



SAE J-1926 / ISO 11926-1 / MS-16142

Inserts

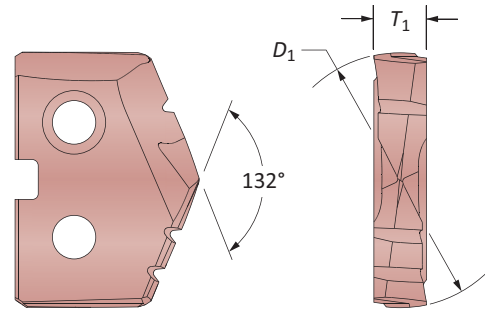
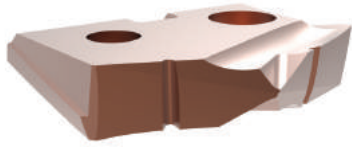

See section A3 for complete T-A insert details

Original T-A® / GEN2 T-A® Drill Inserts

Tube Dash No.	AccuPort Part No.	T-A® Insert Series	Part No.		Insert Screw	Insert Driver	Admissible Tightening Torque**
			Super Cobalt	Carbide			
-4	J1926-04Y-16FM	Y	45YH-.386	4C1YH-.386	724-IP7-1	8IP-7	7.4 in/lbs (84 N-cm)
-5	J1926-05Z-16FM	Z	45ZH-11.5	4C1ZH-11.5	7247-IP7-1	8IP-7	7.4 in/lbs (84 N-cm)
-6	J1926-060-20FM	0	450H-13	4C10H-13	72556-IP8-1	8IP-8	15.5 in/lbs (175 N-cm)
-8	J1926-080-20FM	0	450H-0022	4C10H-0022	72567-IP8-1	8IP-8	15.5 in/lbs (175 N-cm)
-10	J1926-101-25FM	1	451H-20.5	4C11H-20.5	7375-IP9-1	8IP-9	27.0 in/lbs (305 N-cm)
-12	J1926-122-32FM	2	452H-25	4C12H-25	7495-IP15-1	8IP-15	61.0 in/lbs (690 N-cm)
-14	J1926-142-32FM	2	452H-28	4C12H-28	7495-IP15-1	8IP-15	61.0 in/lbs (690 N-cm)
-16	J1926-162-32FM	2	452H-1.231	4C12H-1.231	7495-IP15-1	8IP-15	61.0 in/lbs (690 N-cm)
-20	J1926-203-32FM*	3	453H-39	1C53A-39	7514-IP20-1	8IP-20	121.3 in/lbs (1370 N-cm)
-24	J1926-243-32FM*	3	453H-45.5	1C53A-45.5	7514-IP20-1	8IP-20	121.3 in/lbs (1370 N-cm)
-32	J1926-324-32FM*	4	454H-61.5	-	7514-IP20-1	8IP-20	121.3 in/lbs (1370 N-cm)

*NOTICE: Due to the cutting forces generated by this tool, a mechanical chuck is required. Please contact Application Engineering with any questions.

**Tightening torques are calculated with a friction coefficient of $\mu = 0.14$ and develop 90% of ultimate yield strength

Port Form Drill Inserts

Tube Dash No.	AccuPort Part No.	Part No.		Insert Screw	Insert Driver	Admissible Tightening Torque**
		C3 Carbide (AM200®)	C5 Carbide (TiAlN)			
-4	J1926-04Y-16FM	J1926-02-C3H	J1926-02-C5A	72556-IP8-1	8IP-8	15.5 in/lbs (175 N-cm)
-5	J1926-05Z-16FM	J1926-03-C3H	J1926-03-C5A	72556-IP8-1	8IP-8	15.5 in/lbs (175 N-cm)
-6	J1926-060-20FM	J1926-03-C3H	J1926-03-C5A	72556-IP8-1	8IP-8	15.5 in/lbs (175 N-cm)
-8	J1926-080-20FM	J1926-07-C3H	J1926-07-C5A	72556-IP8-1	8IP-8	15.5 in/lbs (175 N-cm)
-10	J1926-101-25FM	J1926-04-C3H	J1926-04-C5A	72556-IP8-1	8IP-8	15.5 in/lbs (175 N-cm)
-12	J1926-122-32FM	J1926-08-C3H	J1926-08-C5A	72556-IP8-1	8IP-8	15.5 in/lbs (175 N-cm)
-14	J1926-142-32FM	J1926-08-C3H	J1926-08-C5A	72556-IP8-1	8IP-8	15.5 in/lbs (175 N-cm)
-16	J1926-162-32FM	J1926-09-C3H	J1926-09-C5A	7375-IP9-1	8IP-9	27.0 in/lbs (305 N-cm)
-20	J1926-203-32FM*	J1926-10-C3H	J1926-10-C5A	7375-IP9-1	8IP-9	27.0 in/lbs (305 N-cm)
-24	J1926-243-32FM*	J1926-11-C3H	J1926-11-C5A	7375-IP9-1	8IP-9	27.0 in/lbs (305 N-cm)
-32	J1926-324-32FM*	J1926-12-C3H	J1926-12-C5A	7375-IP9-1	8IP-9	27.0 in/lbs (305 N-cm)

*NOTICE: Due to the cutting forces generated by this tool, a mechanical chuck is required. Please contact Application Engineering with any questions.

**Tightening torques are calculated with a friction coefficient of $\mu = 0.14$ and develop 90% of ultimate yield strength

A92: 30 - 37

A92: 2 - 4

A92: 18 - 21

Y - 2 series T-A inserts sold in multiples of 2
 3 - 4 series T-A inserts sold in multiples of 1
 Port form inserts sold in multiples of 2
 Insert screws sold in multiples of 10

J
A DRILLING
B BORING
C REAMING
D BURNISHING
E THREADING
X SPECIALS

SAE J-1926 / ISO 11926-1 / MS-16142

Imperial Shank Holders | Extended Minor Diameter Lengths (L_{13})

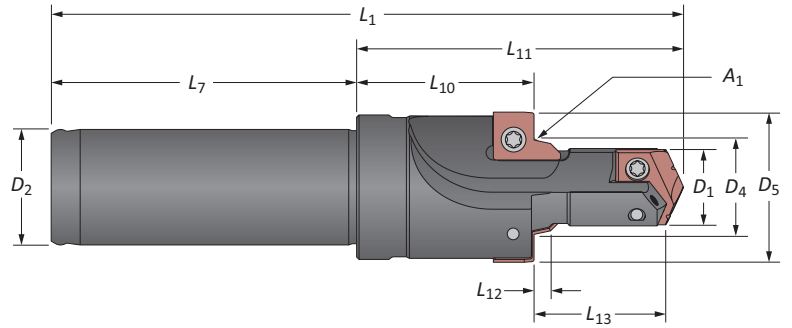

Tube Dash No.	Cutting			Seal Angle			Holder			Shank		Port Thread Size	Part No.
	D_1	L_{13}	D_5	A_1	D_4	L_{12}	L_{11}	L_{10}	L_1	L_7	D_2		
-4	0.386	0.801	0.840	12°	0.490	0.106	1.777	0.896	3.650	1.875	0.625	7/16-20 UNF-2B	X1926-04Y-063F
-5	0.453	0.801	0.926	12°	0.553	0.106	1.777	0.885	3.650	1.875	0.625	1/2-20 UNF-2B	X1926-05Z-063F
-6	0.512	0.860	0.989	12°	0.618	0.106	2.107	1.144	4.070	1.969	0.750	9/16-18 UNF-2B	X1926-060-075F
-8	0.689	0.939	1.206	15°	0.813	0.106	2.232	1.150	4.200	1.969	0.750	3/4-16 UNF-2B	X1926-080-075F
-10	0.807	1.037	1.344	15°	0.945	0.106	2.390	1.185	4.670	2.281	1.000	7/8-14 UNF-2B	X1926-101-100F
i -12	0.984	1.156	1.655	15°	1.150	0.138	2.890	1.530	5.170	2.281	1.250	1 1/16-12 UN-2B	X1926-122-125F
-14	1.102	1.156	1.781	15°	1.276	0.138	2.890	1.504	5.170	2.281	1.250	1 3/16-12 UN-2B	X1926-142-125F
-16	1.231	1.156	1.934	15°	1.400	0.138	2.890	1.477	5.170	2.281	1.250	1 5/16-12 UN-2B	X1926-162-125F
-20	1.535	1.156	2.306	15°	1.715	0.138	3.312	1.835	6.000	2.688	1.500	1 5/8-12 UN-2B	X1926-203-150F
-24	1.791	1.156	2.564	15°	1.965	0.138	3.312	1.778	6.000	2.688	1.500	1 7/8-12 UN-2B	X1926-243-150F
-32	2.421	1.156	3.470	15°	2.589	0.138	4.062	2.393	6.750	2.688	1.500	2 1/2-12 UN-2B	X1926-324-150F
m -4	9.80	20.30	21.30	12°	12.50	2.70	45.10	22.80	92.80	47.60	15.90	7/16-20 UNF-2B	X1926-04Y-063F
-5	11.50	20.30	23.50	12°	14.10	2.70	45.10	22.50	92.80	47.60	15.90	1/2-20 UNF-2B	X1926-05Z-063F
-6	13.00	21.80	25.10	12°	15.70	2.70	53.50	29.00	103.50	50.00	19.10	9/16-18 UNF-2B	X1926-060-075F
-8	17.50	23.80	30.60	15°	20.70	2.70	56.70	29.20	106.70	50.00	19.10	3/4-16 UNF-2B	X1926-080-075F
-10	20.50	26.30	34.10	15°	24.00	2.70	60.70	30.10	118.60	57.90	25.40	7/8-14 UNF-2B	X1926-101-100F
m -12	25.00	29.30	42.00	15°	29.20	3.50	73.40	38.90	131.30	57.90	31.80	1 1/16-12 UN-2B	X1926-122-125F
-14	28.00	29.30	45.20	15°	32.40	3.50	73.40	38.20	131.30	57.90	31.80	1 3/16-12 UN-2B	X1926-142-125F
-16	31.20	29.30	49.10	15°	35.60	3.50	73.40	37.50	131.30	57.90	31.80	1 5/16-12 UN-2B	X1926-162-125F
-20	39.00	29.30	58.50	15°	43.60	3.50	84.10	46.60	152.40	68.30	38.10	1 5/8-12 UN-2B	X1926-203-150F
-24	45.50	29.30	65.10	15°	49.90	3.50	84.10	45.20	152.40	68.30	38.10	1 7/8-12 UN-2B	X1926-243-150F
-32	61.50	29.30	88.10	15°	65.80	3.50	103.20	60.80	171.40	68.30	38.10	2 1/2-12 UN-2B	X1926-324-150F

A92: 30 - 37 A92: 2 - 4 A92: 18 - 21

Key on A92: 1

i = Imperial (in)
m = Metric (mm)



SAE J-1926 / ISO 11926-1 / MS-16142

Inserts

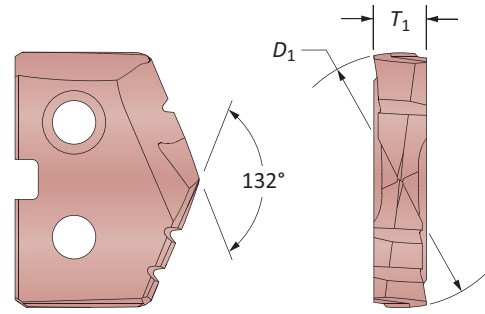

See section A3 for complete T-A insert details

Original T-A® / GEN2 T-A® Drill Inserts

Tube Dash No.	AccuPort Part No.	T-A® Insert Series	Part No.		Insert Screw	Insert Driver	Admissible Tightening Torque*
			Super Cobalt	Carbide			
-4	X1926-04Y-063F	Y	45YH-.386	4C1YH-.386	724-IP7-1	8IP-7	7.4 in/lbs (84 N-cm)
-5	X1926-05Z-063F	Z	45ZH-11.5	4C1ZH-11.5	7247-IP7-1	8IP-7	7.4 in/lbs (84 N-cm)
-6	X1926-060-075F	0	450H-13	4C10H-13	72556-IP8-1	8IP-8	15.5 in/lbs (175 N-cm)
-8	X1926-080-075F	0	450H-0022	4C10H-0022	72567-IP8-1	8IP-8	15.5 in/lbs (175 N-cm)
-10	X1926-101-100F	1	451H-20.5	4C11H-20.5	7375-IP9-1	8IP-9	27.0 in/lbs (305 N-cm)
-12	X1926-122-125F	2	452H-25	4C12H-25	7495-IP15-1	8IP-15	61.0 in/lbs (690 N-cm)
-14	X1926-142-125F	2	452H-28	4C12H-28	7495-IP15-1	8IP-15	61.0 in/lbs (690 N-cm)
-16	X1926-162-125F	2	452H-1.231	4C12H-1.231	7495-IP15-1	8IP-15	61.0 in/lbs (690 N-cm)
-20	X1926-203-150F	3	453H-39	1C53A-39	7514-IP20-1	8IP-20	121.3 in/lbs (1370 N-cm)
-24	X1926-243-150F	3	453H-45.5	1C53A-45.5	7514-IP20-1	8IP-20	121.3 in/lbs (1370 N-cm)
-32	X1926-324-150F	4	454H-61.5	-	7514-IP20-1	8IP-20	121.3 in/lbs (1370 N-cm)

*Tightening torques are calculated with a friction coefficient of $\mu = 0.14$ and develop 90% of ultimate yield strength

Port Form Drill Inserts

Tube Dash No.	AccuPort Part No.	Part No.		Insert Screw	Insert Driver	Admissible Tightening Torque*
		C3 Carbide (AM200®)	C5 Carbide (TiAlN)			
-4	X1926-04Y-063F	J1926-02-C3H	J1926-02-C5A	72556-IP8-1	8IP-8	15.5 in/lbs (175 N-cm)
-5	X1926-05Z-063F	J1926-03-C3H	J1926-03-C5A	72556-IP8-1	8IP-8	15.5 in/lbs (175 N-cm)
-6	X1926-060-075F	J1926-03-C3H	J1926-03-C5A	72556-IP8-1	8IP-8	15.5 in/lbs (175 N-cm)
-8	X1926-080-075F	J1926-07-C3H	J1926-07-C5A	72556-IP8-1	8IP-8	15.5 in/lbs (175 N-cm)
-10	X1926-101-100F	J1926-04-C3H	J1926-04-C5A	72556-IP8-1	8IP-8	15.5 in/lbs (175 N-cm)
-12	X1926-122-125F	J1926-08-C3H	J1926-08-C5A	72556-IP8-1	8IP-8	15.5 in/lbs (175 N-cm)
-14	X1926-142-125F	J1926-08-C3H	J1926-08-C5A	72556-IP8-1	8IP-8	15.5 in/lbs (175 N-cm)
-16	X1926-162-125F	J1926-09-C3H	J1926-09-C5A	7375-IP9-1	8IP-9	27.0 in/lbs (305 N-cm)
-20	X1926-203-150F	J1926-10-C3H	J1926-10-C5A	7375-IP9-1	8IP-9	27.0 in/lbs (305 N-cm)
-24	X1926-243-150F	J1926-11-C3H	J1926-11-C5A	7375-IP9-1	8IP-9	27.0 in/lbs (305 N-cm)
-32	X1926-324-150F	J1926-12-C3H	J1926-12-C5A	7375-IP9-1	8IP-9	27.0 in/lbs (305 N-cm)

*Tightening torques are calculated with a friction coefficient of $\mu = 0.14$ and develop 90% of ultimate yield strength

A92: 30 - 37

A92: 2 - 4

A92: 18 - 21

Y - 2 series T-A inserts sold in multiples of 2
 3 - 4 series T-A inserts sold in multiples of 1
 Port form inserts sold in multiples of 2
 Insert screws sold in multiples of 10

X
 A DRILLING
 B BORING
 C REAMING
 D BURNISHING
 E THREADING
 X SPECIALS

ISO 6149-1:2006 / SAE J-2244/1

Metric Shank Holders

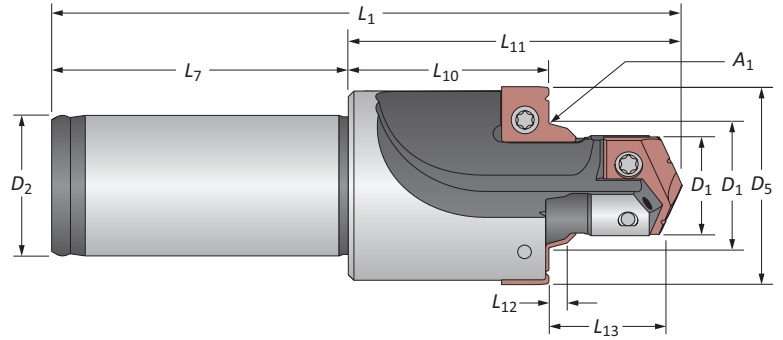

Tube Dash No.	Cutting			Seal Angle			Holder			Shank		Port Thread Size	Part No.
	D ₁	L ₁₃	D ₅	A ₁	D ₄	L ₁₂	L ₁₁	L ₁₀	L ₁	L ₇	D ₂		
-4	0.413	0.556	0.945	15°	0.544	0.102	1.527	0.876	3.180	1.650	0.630	M12 X 1.5	I6149-04RY-16FM
-5	0.492	0.556	1.024	15°	0.623	0.102	1.527	0.858	3.180	1.650	0.630	M14 X 1.5	I6149-05RZ-16FM
-6	0.571	0.615	1.102	15°	0.702	0.102	1.857	1.116	3.510	1.650	0.787	M16 X 1.5	I6149-06R0-20FM
-8	0.650	0.674	1.181	15°	0.781	0.102	1.982	1.164	3.630	1.650	0.787	M18 X 1.5	I6149-08R0-20FM
-10	0.807	0.717	1.339	15°	0.938	0.102	2.140	1.246	4.230	2.091	0.984	M22 X 1.5	I6149-10R1-25FM
i -12	0.984	0.874	1.575	15°	1.159	0.130	2.640	1.552	4.920	2.280	1.260	M27 X 2	I6149-12R2-32FM
-14	1.102	0.874	1.733	15°	1.277	0.130	2.640	1.526	4.920	2.280	1.260	M30 X 2	I6149-14R2-32FM
-16	1.220	0.874	1.929	15°	1.395	0.130	2.640	1.499	4.920	2.280	1.260	M33 X 2	I6149-16R2-32FM
-20	1.575	0.895	2.362	15°	1.749	0.130	3.062	1.828	5.640	2.580	1.260	M42 X 2	I6149-20R3-32FM*
-24	1.811	0.993	2.602	15°	1.985	0.130	3.062	1.676	5.640	2.580	1.260	M48 X 2	I6149-24R3-32FM*
-32	2.283	1.092	2.992	15°	2.458	0.130	3.812	2.228	6.390	2.580	1.260	M60 X 2	I6149-32R4-32FM*
<hr/>													
m -4	10.50	14.10	24.00	15°	13.81	2.60	38.80	22.20	80.70	41.90	16.00	M12 X 1.5	I6149-04RY-16FM
-5	12.50	14.10	26.00	15°	15.80	2.60	38.80	21.80	80.70	41.90	16.00	M14 X 1.5	I6149-05RZ-16FM
-6	14.50	15.60	28.00	15°	17.80	2.60	47.20	28.30	89.10	41.90	20.00	M16 X 1.5	I6149-06R0-20FM
-8	16.50	17.10	30.00	15°	19.80	2.60	50.30	29.60	92.20	41.90	20.00	M18 X 1.5	I6149-08R0-20FM
-10	20.50	18.20	34.00	15°	23.80	2.60	54.40	31.60	107.50	53.10	25.00	M22 X 1.5	I6149-10R1-25FM
m -12	25.00	22.20	40.00	15°	29.40	3.30	67.10	39.40	125.00	57.90	32.00	M27 X 2	I6149-12R2-32FM
-14	28.00	22.20	44.00	15°	32.40	3.30	67.10	38.80	125.00	57.90	32.00	M30 X 2	I6149-14R2-32FM
-16	31.00	22.20	49.00	15°	35.40	3.30	67.10	38.10	125.00	57.90	32.00	M33 X 2	I6149-16R2-32FM
-20	40.00	22.70	60.00	15°	44.40	3.30	77.80	46.40	143.30	65.50	32.00	M42 X 2	I6149-20R3-32FM*
-24	46.00	25.20	66.10	15°	50.40	3.30	77.80	42.60	143.30	65.50	32.00	M48 X 2	I6149-24R3-32FM*
-32	58.00	27.70	76.00	15°	62.40	3.30	96.80	56.60	162.30	65.50	32.00	M60 X 2	I6149-32R4-32FM*

***NOTICE:** Due to the cutting forces generated by this tool, a mechanical chuck is required. Please contact Application Engineering with any questions.

A92: 30 - 37

A92: 2 - 4

A92: 22 - 25

Key on A92: 1

i = Imperial (in)
m = Metric (mm)



ISO 6149-1:2006 / SAE J-2244/1

Inserts

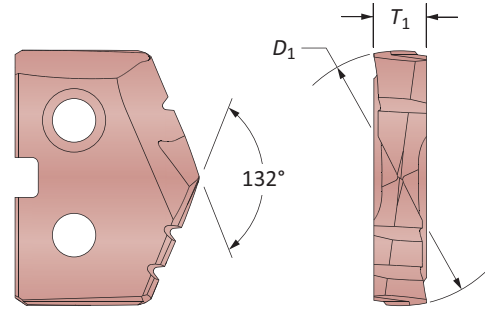
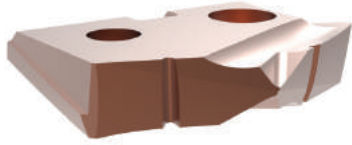

See section A3 for complete T-A insert details

Original T-A® / GEN2 T-A® Drill Inserts

Tube Dash No.	AccuPort Part No.	T-A® Insert Series	Part No.		Insert Screw	Insert Driver	Admissible Tightening Torque**
			Super Cobalt	Carbide			
-4	I6149-04RY-16FM	Y	45YH-10.5	4C1YH-10.5	724-IP7-1	8IP-7	7.4 in/lbs (84 N-cm)
-5	I6149-05RZ-16FM	Z	45ZH-12.5	4C1ZH-12.5	7247-IP7-1	8IP-7	7.4 in/lbs (84 N-cm)
-6	I6149-06R0-20FM	0	450H-14.5	4C10H-14.5	72567-IP8-1	8IP-8	15.5 in/lbs (175 N-cm)
-8	I6149-08R0-20FM	0	450H-16.5	4C10H-16.5	72567-IP8-1	8IP-8	15.5 in/lbs (175 N-cm)
-10	I6149-10R1-25FM	1	451H-20.5	4C11H-20.5	7375-IP9-1	8IP-9	27.0 in/lbs (305 N-cm)
-12	I6149-12R2-32FM	2	452H-25	4C12H-25	7495-IP15-1	8IP-15	61.0 in/lbs (690 N-cm)
-14	I6149-14R2-32FM	2	452H-28	4C12H-28	7495-IP15-1	8IP-15	61.0 in/lbs (690 N-cm)
-16	I6149-16R2-32FM	2	452H-31	4C12H-31	7495-IP15-1	8IP-15	61.0 in/lbs (690 N-cm)
-20	I6149-20R3-32FM*	3	453H-40	1C53A-40	7514-IP20-1	8IP-20	121.3 in/lbs (1370 N-cm)
-24	I6149-24R3-32FM*	3	453H-46	1C53A-46	7514-IP20-1	8IP-20	121.3 in/lbs (1370 N-cm)
-32	I6149-32R4-32FM*	4	454H-58	-	7514-IP20-1	8IP-20	121.3 in/lbs (1370 N-cm)

*NOTICE: Due to the cutting forces generated by this tool, a mechanical chuck is required. Please contact Application Engineering with any questions.

**Tightening torques are calculated with a friction coefficient of $\mu = 0.14$ and develop 90% of ultimate yield strength

Port Form Drill Inserts

Tube Dash No.	AccuPort Part No.	Part No. - C3 Carbide (AM200®)		Part No. - C5 Carbide (TiAlN)		Insert Screw	Insert Driver	Admissible Tightening Torque**
		ID Ridge	No ID Ridge	ID Ridge	No ID Ridge			
-4	I6149-04RY-16FM	I6149-04R-C3H	I6149-04-C3H	I6149-04R-C5A	I6149-04-C5A	72556-IP8-1	8IP-8	15.5 in/lbs (175 N-cm)
-5	I6149-05RZ-16FM	I6149-04R-C3H	I6149-04-C3H	I6149-04R-C5A	I6149-04-C5A	72556-IP8-1	8IP-8	15.5 in/lbs (175 N-cm)
-6	I6149-06R0-20FM	I6149-06R-C3H	I6149-06-C3H	I6149-06R-C5A	I6149-06-C5A	72556-IP8-1	8IP-8	15.5 in/lbs (175 N-cm)
-8	I6149-08R0-20FM	I6149-06R-C3H	I6149-06-C3H	I6149-06R-C5A	I6149-06-C5A	72556-IP8-1	8IP-8	15.5 in/lbs (175 N-cm)
-10	I6149-10R1-25FM	I6149-04R-C3H	I6149-04-C3H	I6149-04R-C5A	I6149-04-C5A	72556-IP8-1	8IP-8	15.5 in/lbs (175 N-cm)
-12	I6149-12R2-32FM	I6149-12R-C3H	I6149-12-C3H	I6149-12R-C5A	I6149-12-C5A	72556-IP8-1	8IP-8	15.5 in/lbs (175 N-cm)
-14	I6149-14R2-32FM	I6149-14R-C3H	I6149-14-C3H	I6149-14R-C5A	I6149-14-C5A	72556-IP8-1	8IP-8	15.5 in/lbs (175 N-cm)
-16	I6149-16R2-32FM	I6149-16R-C3H	I6149-16-C3H	I6149-16R-C5A	I6149-16-C5A	7375-IP9-1	8IP-9	27.0 in/lbs (305 N-cm)
-20	I6149-20R3-32FM*	I6149-20R-C3H	I6149-20-C3H	I6149-20R-C5A	I6149-20-C5A	7375-IP9-1	8IP-9	27.0 in/lbs (305 N-cm)
-24	I6149-24R3-32FM*	I6149-24R-C3H	I6149-24-C3H	I6149-24R-C5A	I6149-24-C5A	7375-IP9-1	8IP-9	27.0 in/lbs (305 N-cm)
-32	I6149-32R4-32FM*	I6149-32R-C3H	I6149-32-C3H	I6149-32R-C5A	I6149-32-C5A	7375-IP9-1	8IP-9	27.0 in/lbs (305 N-cm)

*NOTICE: Due to the cutting forces generated by this tool, a mechanical chuck is required. Please contact Application Engineering with any questions.

**Tightening torques are calculated with a friction coefficient of $\mu = 0.14$ and develop 90% of ultimate yield strength

A92: 30 - 37

A92: 2 - 4

A92: 22 - 25

Y - 2 series T-A inserts sold in multiples of 2
 3 - 4 series T-A inserts sold in multiples of 1
 Port form inserts sold in multiples of 2
 Insert screws sold in multiples of 10

SAE AS5202 / AND10050

Imperial Shank Holders

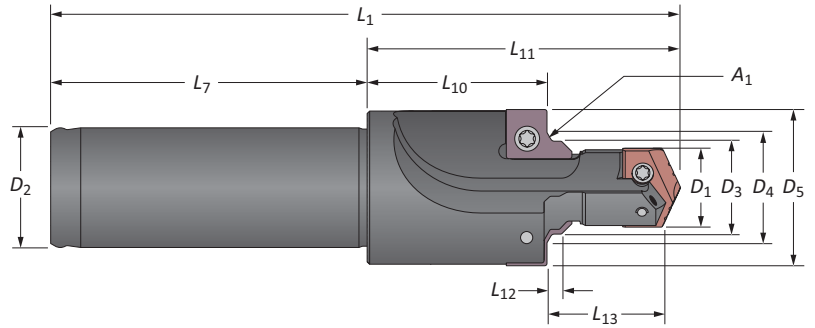

Tube Dash No.	Cutting				Seal Angle			Holder				Shank		Port Thread Size	Port Thread Size*	Part No.
	D ₁	D ₁ *	L ₁₃	D ₅	A ₁	D ₄	L ₁₂	D ₃	L ₁₁	L ₁₀	L ₁	L ₇	D ₂			
-4	0.390	0.386	0.661	0.875	60°	0.564	0.083	0.454	1.637	0.896	3.510	1.875	0.625	7/16-20 UNJF-3B	7/16-20 UNF-3B	AS5202-04Y-063F
-5	0.453	0.451	0.661	0.916	60°	0.625	0.083	0.517	1.637	0.882	3.510	1.875	0.625	1/2-20 UNJF-3B	1/2-20 UNF-3B	AS5202-05Z-063F
-6	0.510	0.506	0.714	0.979	60°	0.688	0.083	0.580	1.940	1.119	3.910	1.969	0.750	9/16-18 UNJF-3B	9/16-18 UNF-3B	AS5202-06Z-075F
-8	0.689	0.688	0.839	1.198	60°	0.875	0.094	0.769	2.107	1.125	4.080	1.969	0.750	3/4-16 UNJF-3B	3/4-16 UNF-3B	AS5202-080-075F
-10	0.807	0.801	0.935	1.354	60°	1.002	0.107	0.896	2.290	1.189	4.570	2.281	1.000	7/8-14 UNJF-3B	7/8-14 UNF-3B	AS5202-101-100F
i -12	0.984	0.976	1.069	1.635	60°	1.237	0.125	1.086	2.765	1.494	5.050	2.281	1.250	1 1/16-12 UNJ-3B	1 1/16-12 UN-3B	AS5202-122-125F
-14	1.109	1.102	1.069	1.775	60°	1.363	0.125	1.211	2.765	1.465	5.050	2.281	1.250	1 3/16-12 UNJ-3B	1 3/16-12 UN-3B	AS5202-142-125F
-16	1.234	1.226	1.069	1.920	60°	1.487	0.125	1.336	2.765	1.437	5.050	2.281	1.250	1 5/16-12 UNJ-3B	1 5/16-12 UN-3B	AS5202-162-125F
-20	1.547	1.535	1.121	2.280	60°	1.799	0.125	1.648	3.187	1.745	5.880	2.688	1.500	1 5/8-12 UNJ-3B	1 5/8-12 UN-3B	AS5202-203-150F
-24	1.797	1.791	1.132	2.570	60°	2.050	0.125	1.898	3.187	1.676	5.880	2.688	1.500	1 7/8-12 UNJ-3B	1 7/8-12 UN-3B	AS5202-243-150F
-32	2.421	2.413	1.373	3.490	60°	2.676	0.125	2.524	3.687	1.802	6.380	2.688	1.500	2 1/2-12 UNJ-3B	2 1/2-12 UN-3B	AS5202-324-150F
m -4	9.90	9.80	16.79	22.23	60°	14.34	2.11	11.53	41.58	22.76	89.20	47.63	15.88	7/16-20 UNJF-3B	7/16-20 UNF-3B	AS5202-04Y-063F
m -5	11.50	11.45	16.79	23.27	60°	15.88	2.11	13.13	41.58	22.39	89.20	47.63	15.88	1/2-20 UNJF-3B	1/2-20 UNF-3B	AS5202-05Z-063F
m -6	12.95	12.85	18.14	24.87	60°	17.46	2.11	14.73	49.28	28.43	99.29	50.01	19.05	9/16-18 UNJF-3B	9/16-18 UNF-3B	AS5202-06Z-075F
m -8	17.50	17.46	21.31	30.43	60°	22.23	2.39	19.53	53.52	28.57	103.53	50.01	19.05	3/4-16 UNJF-3B	3/4-16 UNF-3B	AS5202-080-075F
m -10	20.50	20.35	23.75	34.39	60°	25.46	2.72	22.76	58.17	30.19	116.10	57.94	25.40	7/8-14 UNJF-3B	7/8-14 UNF-3B	AS5202-101-100F
m -12	25.00	24.80	27.15	41.53	60°	31.42	3.18	27.58	70.23	37.94	128.17	57.94	31.75	1 1/16-12 UNJ-3B	1 1/16-12 UN-3B	AS5202-122-125F
m -14	28.17	28.00	27.15	45.09	60°	34.61	3.18	30.76	70.23	37.22	128.17	57.94	31.75	1 3/16-12 UNJ-3B	1 3/16-12 UN-3B	AS5202-142-125F
m -16	31.34	31.15	27.15	48.77	60°	37.77	3.18	33.93	70.23	36.51	128.17	57.94	31.75	1 5/16-12 UNJ-3B	1 5/16-12 UN-3B	AS5202-162-125F
m -20	39.29	39.00	28.47	57.91	60°	45.69	3.18	41.86	80.95	44.32	149.23	68.28	38.10	1 5/8-12 UNJ-3B	1 5/8-12 UN-3B	AS5202-203-150F
m -24	45.64	45.50	28.75	65.28	60°	52.07	3.18	48.21	80.95	42.58	149.23	68.28	38.10	1 7/8-12 UNJ-3B	1 7/8-12 UN-3B	AS5202-243-150F
m -32	61.49	61.30	34.87	88.65	60°	67.97	3.18	64.11	93.65	45.78	161.93	68.28	38.10	2 1/2-12 UNJ-3B	2 1/2-12 UN-3B	AS5202-324-150F

*AND10050 specifications shown in red

A92: 30 - 37 A92: 2 - 4 A92: 26 - 27

Key on A92: 1

i = Imperial (in)
m = Metric (mm)



SAE AS5202 / AND10050

Inserts

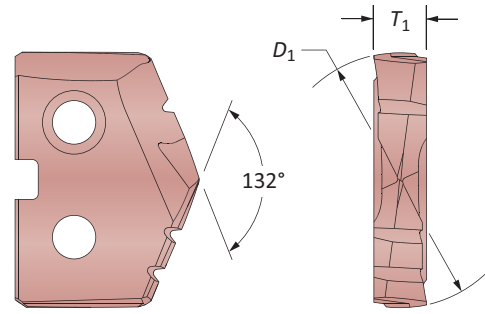
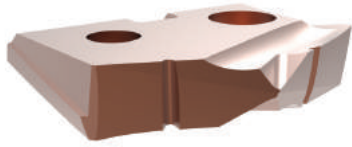

See section A3 for complete T-A insert details

Original T-A® / GEN2 T-A® Drill Inserts

Tube Dash No.	AccuPort Part No.	T-A® Insert Series	Part No.				Insert Screw	Insert Driver	Admissible Tightening Torque*
			Super Cobalt		Carbide				
-4	AS5202-04Y-063F	Y	45YH-.390	45YH-.386	4C1YH-.390	4C1YH-.386	724-IP7-1	8IP-7	7.4 in/lbs (84 N-cm)
-5	AS5202-05Z-063F	Z	45ZH-11.5	45ZH-.451	4C1ZH-11.5	4C1ZH-.451	7247-IP7-1	8IP-7	7.4 in/lbs (84 N-cm)
-6	AS5202-06Z-075F	Z	45ZH-.510	45ZH-.506	4C1ZH-.510	4C1ZH-.506	72567-IP8-1	8IP-8	15.5 in/lbs (175 N-cm)
-8	AS5202-080-075F	0	450H-17.5	450H-0022	4C10H-17.5	4C10H-0022	72567-IP8-1	8IP-8	15.5 in/lbs (175 N-cm)
-10	AS5202-101-100F	1	451H-20.5	451H-.801	4C11H-20.5	4C11H-.801	739-IP9-1	8IP-9	27.0 in/lbs (305 N-cm)
-12	AS5202-122-125F	2	452H-25	452H-.976	4C12H-25	4C12H-.976	7495-IP15-1	8IP-15	61.0 in/lbs (690 N-cm)
-14	AS5202-142-125F	2	452H-1.109	452H-28	4C12H-1.109	4C12H-28	7495-IP15-1	8IP-15	61.0 in/lbs (690 N-cm)
-16	AS5202-162-125F	2	452H-1.234	452H-1.226	4C12H-1.234	4C12H-1.226	7495-IP15-1	8IP-15	61.0 in/lbs (690 N-cm)
-20	AS5202-203-150F	3	453H-1.547	453H-39	1C53A-1.547	1C53A-39	7514-IP20-1	8IP-20	121.3 in/lbs (1370 N-cm)
-24	AS5202-243-150F	3	453H-1.797	453H-45.5	1C53A-1.797	1C53A-45.5	7514-IP20-1	8IP-20	121.3 in/lbs (1370 N-cm)
-32	AS5202-324-150F	4	454H-2.421	454H-2.413	-	-	7514-IP20-1	8IP-20	121.3 in/lbs (1370 N-cm)

*Tightening torques are calculated with a friction coefficient of $\mu = 0.14$ and develop 90% of ultimate yield strength

NOTE: AND10050 specifications shown in red

Port Form Drill Inserts

Tube Dash No.	AccuPort Part No.	Part No.		Insert Screw	Insert Driver	Admissible Tightening Torque*
		C5 Carbide (TiAlN)				
-4	AS5202-04Y-063F	AS5202-04-C5A		72556-IP8-1	8IP-8	15.5 in/lbs (175 N-cm)
-5	AS5202-05Z-063F	AS5202-05-C5A		72556-IP8-1	8IP-8	15.5 in/lbs (175 N-cm)
-6	AS5202-06Z-075F	AS5202-06-C5A		72556-IP8-1	8IP-8	15.5 in/lbs (175 N-cm)
-8	AS5202-080-075F	AS5202-08-C5A		72556-IP8-1	8IP-8	15.5 in/lbs (175 N-cm)
-10	AS5202-101-100F	AS5202-10-C5A		7495-IP15-1	8IP-15	61.0 in/lbs (690 N-cm)
-12	AS5202-122-125F	AS5202-12-C5A		7495-IP15-1	8IP-15	61.0 in/lbs (690 N-cm)
-14	AS5202-142-125F	AS5202-14-C5A		7495-IP15-1	8IP-15	61.0 in/lbs (690 N-cm)
-16	AS5202-162-125F	AS5202-16-C5A		7495-IP15-1	8IP-15	61.0 in/lbs (690 N-cm)
-20	AS5202-203-150F	AS5202-20-C5A		7495-IP15-1	8IP-15	61.0 in/lbs (690 N-cm)
-24	AS5202-243-150F	AS5202-24-C5A		7495-IP15-1	8IP-15	61.0 in/lbs (690 N-cm)
-32	AS5202-324-150F	AS5202-32-C5A		7495-IP15-1	8IP-15	61.0 in/lbs (690 N-cm)

*Tightening torques are calculated with a friction coefficient of $\mu = 0.14$ and develop 90% of ultimate yield strength

A92: 30 - 37

A92: 2 - 4

A92: 26 - 27

Y - 2 series T-A inserts sold in multiples of 2
 3 - 4 series T-A inserts sold in multiples of 1
 Port form inserts sold in multiples of 2
 Insert screws sold in multiples of 10

JDS-G173.1

Metric Shank Holders

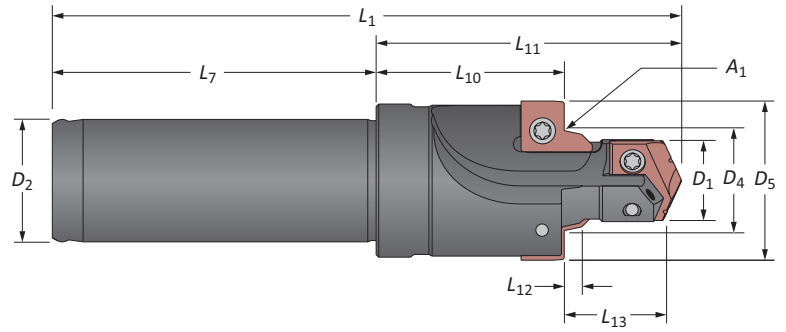

Tube Dash No.	Cutting			Seal Angle			Holder			Shank		Port Thread Size	Part No.
	D ₁	L ₁₃	D ₅	A ₁	D ₄	L ₁₂	L ₁₁	L ₁₀	L ₁	L ₇	D ₂		
-4	0.413	0.709	0.945	15°	0.547	0.104	1.580	0.875	3.320	1.650	0.630	M12 X 1.5	G1731-04Y-16FM
-5	0.492	0.709	1.024	15°	0.626	0.104	1.580	0.858	3.320	1.650	0.630	M14 X 1.5	G1731-05Z-16FM
-6	0.571	0.748	1.142	15°	0.705	0.104	1.870	1.117	3.630	1.650	0.787	M16 X 1.5	G1731-06O-20FM
-8	0.650	0.827	1.220	15°	0.783	0.104	2.020	1.161	3.770	1.650	0.787	M18 X 1.5	G1731-08O-20FM
-10	0.807	0.866	1.378	15°	0.941	0.104	2.140	1.246	4.370	2.090	0.984	M22 X 1.5	G1731-10I-25FM
-12	0.984	1.063	1.614	15°	1.161	0.132	2.680	1.553	5.100	2.280	1.260	M27 X 2	G1731-12Z-32FM
i -14	1.102	1.063	1.732	15°	1.280	0.132	2.680	1.526	5.100	2.280	1.260	M30 X 2	G1731-14Z-32FM
-16	1.221	1.063	1.969	15°	1.398	0.132	2.680	1.500	5.100	2.280	1.260	M33 X 2	G1731-16Z-32FM
-18	1.417	1.063	2.165	15°	1.594	0.132	3.020	1.844	5.780	2.580	1.260	M38 X 2	G1731-183-32FM*
-20	1.575	1.063	2.402	15°	1.752	0.132	3.020	1.809	5.780	2.580	1.260	M42 X 2	G1731-203-32FM*
-24	1.811	1.142	2.638	15°	1.988	0.132	3.020	1.687	5.780	2.580	1.260	M48 X 2	G1731-243-32FM*
-32	2.284	1.260	3.031	15°	2.461	0.132	3.780	2.300	6.550	2.580	1.260	M60 X 2	G1731-324-32FM*
C**	0.728	0.787	1.299	15°	0.862	0.104	2.000	1.281	4.230	2.090	0.984	M20 X 1.5	G1731-CV1-25FM
<hr/>													
-4	10.50	18.00	24.00	15°	13.90	2.65	40.10	22.20	84.50	41.90	16.00	M12 X 1.5	G1731-04Y-16FM
-5	12.50	18.00	26.00	15°	15.90	2.65	40.10	21.80	84.50	41.90	16.00	M14 X 1.5	G1731-05Z-16FM
-6	14.50	19.00	29.00	15°	17.90	2.65	47.60	28.40	92.20	41.90	20.00	M16 X 1.5	G1731-06O-20FM
-8	16.50	21.00	31.00	15°	19.90	2.65	51.20	29.50	95.80	41.90	20.00	M18 X 1.5	G1731-08O-20FM
-10	20.50	22.00	35.00	15°	23.90	2.65	54.40	31.60	111.00	53.10	25.00	M22 X 1.5	G1731-10I-25FM
-12	25.00	27.00	41.00	15°	29.50	3.35	68.10	39.40	129.60	57.90	32.00	M27 X 2	G1731-12Z-32FM
-14	28.00	27.00	44.00	15°	32.50	3.35	68.10	39.70	129.60	57.90	32.00	M30 X 2	G1731-14Z-32FM
-16	31.00	27.00	50.00	15°	35.50	3.35	68.10	38.10	129.60	57.90	32.00	M33 X 2	G1731-16Z-32FM
-18	36.00	27.00	55.00	15°	40.50	3.35	76.60	46.80	146.80	65.50	32.00	M38 X 2	G1731-183-32FM*
-20	40.00	27.00	61.00	15°	44.50	3.35	76.60	45.90	146.80	65.50	32.00	M42 X 2	G1731-203-32FM*
-24	46.00	29.00	67.00	15°	50.50	3.35	76.60	42.80	146.80	65.50	32.00	M48 X 2	G1731-243-32FM*
-32	58.00	32.00	77.00	15°	62.50	3.35	96.10	58.40	166.40	65.50	32.00	M60 X 2	G1731-324-32FM*
C**	18.50	20.00	33.00	15°	21.90	2.65	50.80	32.50	107.40	53.10	25.00	M20 X 1.5	G1731-CV1-25FM

*NOTICE: Due to the cutting forces generated by this tool, a mechanical chuck is required. Please contact Application Engineering with any questions.

**Cartridge cavity

A92: 30 - 37

A92: 2 - 4

A92: 28

Key on A92: 1

i = Imperial (in)
m = Metric (mm)



JDS-G173.1

Inserts

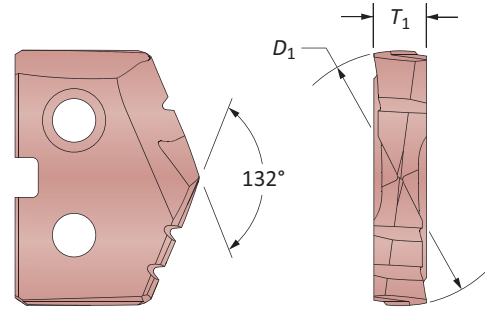

See section A3 for complete T-A insert details

GEN2 T-A® Drill Inserts

Tube Dash No.	AccuPort Part No.	T-A® Insert Series	Part No.		Insert Screw	Insert Driver	Admissible Tightening Torque**
			Super Cobalt	Carbide			
-4	G1731-04Y-16FM	Y	45YH-10.5	4C2YH-10.5	724-IP7-1	8IP-7	7.4 in/lbs (84 N-cm)
-5	G1731-05Z-16FM	Z	45ZH-12.5	4C2ZH-12.5	7247-IP7-1	8IP-7	7.4 in/lbs (84 N-cm)
-6	G1731-060-20FM	0	450H-14.5	4C20H-14.5	72567-IP8-1	8IP-8	15.5 in/lbs (175 N-cm)
-8	G1731-080-20FM	0	450H-16.5	4C20H-16.5	72567-IP8-1	8IP-8	15.5 in/lbs (175 N-cm)
-10	G1731-101-25FM	1	451H-20.5	4C21H-20.5	739-IP9-1	8IP-9	27.0 in/lbs (305 N-cm)
-12	G1731-122-32FM	2	452H-25	4C22H-25	7495-IP15-1	8IP-15	61.0 in/lbs (690 N-cm)
-14	G1731-142-32FM	2	452H-28	4C22H-28	7495-IP15-1	8IP-15	61.0 in/lbs (690 N-cm)
-16	G1731-162-32FM	2	452H-31	4C22H-31	7495-IP15-1	8IP-15	61.0 in/lbs (690 N-cm)
-18	G1731-183-32FM*	3	453H-36	-	7514-IP20-1	8IP-20	121.3 in/lbs (1370 N-cm)
-20	G1731-203-32FM*	3	453H-40	-	7514-IP20-1	8IP-20	121.3 in/lbs (1370 N-cm)
-24	G1731-243-32FM*	3	453H-46	-	7514-IP20-1	8IP-20	121.3 in/lbs (1370 N-cm)
-32	G1731-324-32FM*	4	454H-58	-	7514-IP20-1	8IP-20	121.3 in/lbs (1370 N-cm)
C***	G1731-CV1-25FM	1	451H-18.5	4C21H-18.5	739-IP9-1	8IP-9	27.0 in/lbs (305 N-cm)

*NOTICE: Due to the cutting forces generated by this tool, a mechanical chuck is required. Please contact Application Engineering with any questions.

**Tightening torques are calculated with a friction coefficient of $\mu = 0.14$ and develop 90% of ultimate yield strength

***Cartridge cavity

Port Form Drill Inserts

Tube Dash No.	AccuPort Part No.	Part No.		Insert Screw	Insert Driver	Admissible Tightening Torque**
		C3 Carbide (AM200®)				
-4	G1731-04Y-16FM	G1731-01-C3H		72556-IP8-1	8IP-8	15.5 in/lbs (175 N-cm)
-5	G1731-05Z-16FM	G1731-01-C3H		72556-IP8-1	8IP-8	15.5 in/lbs (175 N-cm)
-6	G1731-060-20FM	G1731-02-C3H		72556-IP8-1	8IP-8	15.5 in/lbs (175 N-cm)
-8	G1731-080-20FM	G1731-02-C3H		72556-IP8-1	8IP-8	15.5 in/lbs (175 N-cm)
-10	G1731-101-25FM	G1731-02-C3H		72556-IP8-1	8IP-8	15.5 in/lbs (175 N-cm)
-12	G1731-122-32FM	G1731-03-C3H		72556-IP8-1	8IP-8	15.5 in/lbs (175 N-cm)
-14	G1731-142-32FM	G1731-03-C3H		72556-IP8-1	8IP-8	15.5 in/lbs (175 N-cm)
-16	G1731-162-32FM	G1731-04-C3H		7375-IP9-1	8IP-9	27.0 in/lbs (305 N-cm)
-18	G1731-183-32FM*	G1731-04-C3H		7375-IP9-1	8IP-9	27.0 in/lbs (305 N-cm)
-20	G1731-203-32FM*	G1731-05-C3H		7375-IP9-1	8IP-9	27.0 in/lbs (305 N-cm)
-24	G1731-243-32FM*	G1731-05-C3H		7375-IP9-1	8IP-9	27.0 in/lbs (305 N-cm)
-32	G1731-324-32FM*	G1731-06-C3H		7375-IP9-1	8IP-9	27.0 in/lbs (305 N-cm)
C***	G1731-CV1-25FM	G1731-02-C3H		72556-IP8-1	8IP-8	15.5 in/lbs (175 N-cm)

*NOTICE: Due to the cutting forces generated by this tool, a mechanical chuck is required. Please contact Application Engineering with any questions.

**Tightening torques are calculated with a friction coefficient of $\mu = 0.14$ and develop 90% of ultimate yield strength

***Cartridge cavity

A92: 30 - 37

A92: 2 - 4

A92: 28

Y - 2 series T-A inserts sold in multiples of 2
 3 - 4 series T-A inserts sold in multiples of 1
 Port form inserts sold in multiples of 2
 Insert screws sold in multiples of 10

Port and Thread Finishing Kits

J1926 | Imperial | Ferrous Materials

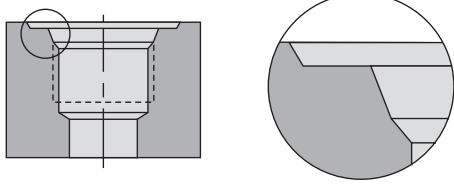

SAE J-1926-1 / ISO 11926-1

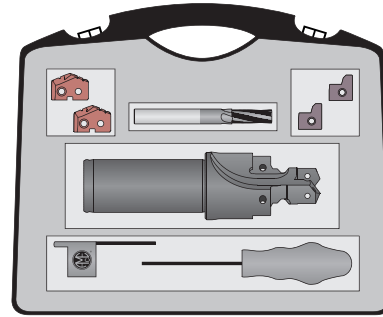

Port and Thread Finishing Kits

Tube Dash No.	AccuPort 432			GEN2 T-A® Insert		Port Form Insert		AccuThread™ Thread Mill		Kit Part No.
	Part No.	Port Thread Size	Qty	Super Cobalt (AM200®)	Qty	C5 Carbide (TiAlN)	Qty	Part No. (AM210®)	Qty	
-4	J1926-04Y-063F	7/16-20 UNF-2B	1	45YH-.386	2	J1926-02-C5A	2	TMAK0438-20	1	ATKK04-1926
-5	J1926-05Z-063F	1/2-20 UNF-2B	1	45ZH-11.5	2	J1926-03-C5A	2	TMAK0438-20	1	ATKK05-1926
-6	J1926-060-075F	9/16-18 UNF-2B	1	450H-13	2	J1926-03-C5A	2	TMAK0563-18	1	ATKK06-1926
-8	J1926-080-075F	3/4-16 UNF-2B	1	450H-0022	2	J1926-07-C5A	2	TMAK0750-16	1	ATKK08-1926
-10	J1926-101-100F	7/8-14 UNF-2B	1	451H-20.5	2	J1926-04-C5A	2	TMAK0875-14	1	ATKK10-1926
-12	J1926-122-125F	1-1/16-12 UN-2B	1	452H-25	2	J1926-08-C5A	2	TMAK1063-12	1	ATKK12-1926
-14	J1926-142-125F	1-3/16-12 UN-2B	1	452H-28	2	J1926-08-C5A	2	TMAK1063-12	1	ATKK14-1926
-16	J1926-162-125F	1-5/16-12 UN-2B	1	452H-1.231	2	J1926-09-C5A	2	TMAK1063-12	1	ATKK16-1926
-20	J1926-203-150F	1-5/8-12 UN-2B	1	453H-39	1	J1926-10-C5A	2	TMAK1063-12	1	ATKK20-1926
-24	J1926-243-150F	1-7/8-12 UN-2B	1	453H-45.5	1	J1926-11-C5A	2	TMAK1063-12	1	ATKK24-1926
-32	J1926-324-150F	2-1/2-12 UN-2B	1	454H-61.5	1	J1926-12-C5A	2	TMAK1063-12	1	ATKK32-1926

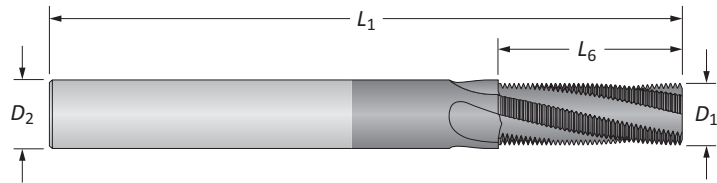

AccuThread™ Port Specific Solid Carbide Thread Mills

Port Size	Pitch	Thread Mill				Flutes	Part No.
		D ₁	L ₆	D ₂	L ₁		
-4 to -5	20	0.335	0.600	0.375	3.5	4	TMAK0438-20
-6	18	0.370	0.666	0.375	3.5	4	TMAK0563-18
-8	16	0.495	0.750	0.500	3.5	4	TMAK0750-16
-10	14	0.495	0.857	0.500	3.5	4	TMAK0875-14
-12 to -32	12	0.495	0.917	0.500	3.5	4	TMAK1063-12

AccuPort 432 specific thread mills - International Unified Series (UN) manufactured specifically for use with AccuPort 432 hydraulic port forms. The length of cut allows full thread with one pass. Conforms with J1926 and SAE AS5202 port form specifications.

A92: 30 - 37 A92: 2 - 4 A92: 6 - 7

Key on A92: 1



Port and Thread Finishing Kits

J1926 | Imperial | Non-Ferrous Materials

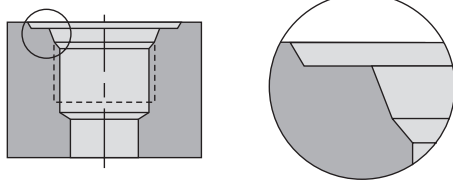

SAE J-1926-1 / ISO 11926-1

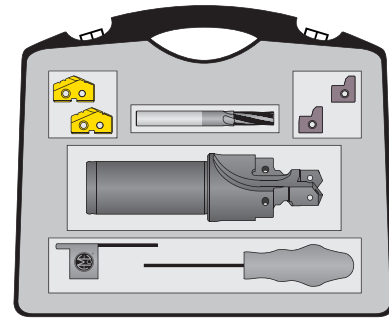

Port and Thread Finishing Kits

Tube Dash No.	AccuPort 432			Original T-A® Insert		Port Form Insert		AccuThread™ Thread Mill		Kit Part No.
	Part No.	Port Thread Size	Qty	Super Cobalt (TiN)	Qty	C5 Carbide (TiAlN)	Qty	Part No. (AM210®)	Qty	
-4	J1926-04Y-063F	7/16-20 UNF-2B	1	15YT-.386	2	J1926-02-C5A	2	TMAU0438-20	1	ATKU04-1926
-5	J1926-05Z-063F	1/2-20 UNF-2B	1	145ZT-11.5	2	J1926-03-C5A	2	TMAU0438-20	1	ATKU05-1926
-6	J1926-060-075F	9/16-18 UNF-2B	1	150T-13	2	J1926-03-C5A	2	TMAU0563-18	1	ATKU06-1926
-8	J1926-080-075F	3/4-16 UNF-2B	1	150T-0022	2	J1926-07-C5A	2	TMAU0750-16	1	ATKU08-1926
-10	J1926-101-100F	7/8-14 UNF-2B	1	151T-20.5	2	J1926-04-C5A	2	TMAU0875-14	1	ATKU10-1926
-12	J1926-122-125F	1-1/16-12 UN-2B	1	152T-25	2	J1926-08-C5A	2	TMAU1063-12	1	ATKU12-1926
-14	J1926-142-125F	1-3/16-12 UN-2B	1	152T-28	2	J1926-08-C5A	2	TMAU1063-12	1	ATKU14-1926
-16	J1926-162-125F	1-5/16-12 UN-2B	1	152T-1.231	2	J1926-09-C5A	2	TMAU1063-12	1	ATKU16-1926
-20	J1926-203-150F	1-5/8-12 UN-2B	1	153T-39	1	J1926-10-C5A	2	TMAU1063-12	1	ATKU20-1926
-24	J1926-243-150F	1-7/8-12 UN-2B	1	153T-45.5	1	J1926-11-C5A	2	TMAU1063-12	1	ATKU24-1926
-32	J1926-324-150F	2-1/2-12 UN-2B	1	154T-61.5	1	J1926-12-C5A	2	TMAU1063-12	1	ATKU32-1926

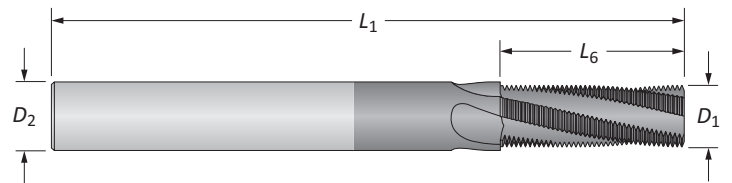

AccuThread™ Port Specific Solid Carbide Thread Mills

Port Size	Pitch	Thread Mill				Flutes	Part No.
		D ₁	L ₆	D ₂	L ₁		
-4 to -5	20	0.335	0.600	0.375	3.5	4	TMAU0438-20
-6	18	0.370	0.666	0.375	3.5	4	TMAU0563-18
-8	16	0.495	0.750	0.500	3.5	4	TMAU0750-16
-10	14	0.495	0.857	0.500	3.5	4	TMAU0875-14
-12 to -32	12	0.495	0.917	0.500	3.5	4	TMAU1063-12

AccuPort 432 specific thread mills - International Unified Series (UN) manufactured specifically for use with AccuPort 432 hydraulic port forms. The length of cut allows full thread with one pass. Conforms with J1926 and SAE A5202 port form specifications.

Key on A92-1

A92: 30 - 37

A92: 2 - 4

A92: 6 - 7

J
A DRILLING
B BORING
C REAMING
D BURNISHING
E THREADING
X SPECIALS

Port and Thread Finishing Kits

J1926 | Metric | Ferrous Materials

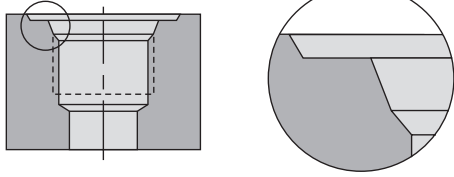

SAE J-1926-1 / ISO 11926-1

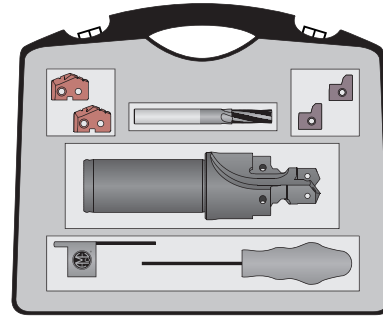

Port and Thread Finishing Kits

Tube Dash No.	AccuPort 432			GEN2 T-A® Insert		Port Form Insert		AccuThread™ Thread Mill		Kit Part No.
	Part No.	Port Thread Size	Qty	Super Cobalt (AM200®)	Qty	C5 Carbide (TiAlN)	Qty	Part No. (AM210®)	Qty	
-4	J1926-04Y-16FM	7/16-20 UNF-2B	1	45YH-.386	2	J1926-02-C5A	2	TMAK0438-20M	1	ATKK04-1926M
-5	J1926-05Z-16FM	1/2-20 UNF-2B	1	45ZH-11.5	2	J1926-03-C5A	2	TMAK0438-20M	1	ATKK05-1926M
-6	J1926-060-20FM	9/16-18 UNF-2B	1	450H-13	2	J1926-03-C5A	2	TMAK0563-18M	1	ATKK06-1926M
-8	J1926-080-20FM	3/4-16 UNF-2B	1	450H-0022	2	J1926-07-C5A	2	TMAK0750-16M	1	ATKK08-1926M
-10	J1926-101-25FM	7/8-14 UNF-2B	1	451H-20.5	2	J1926-04-C5A	2	TMAK0875-14M	1	ATKK10-1926M
-12	J1926-122-32FM	1-1/16-12 UN-2B	1	452H-25	2	J1926-08-C5A	2	TMAK1063-12M	1	ATKK12-1926M
-14	J1926-142-32FM	1-3/16-12 UN-2B	1	452H-28	2	J1926-08-C5A	2	TMAK1063-12M	1	ATKK14-1926M
-16	J1926-162-32FM	1-5/16-12 UN-2B	1	452H-1.231	2	J1926-09-C5A	2	TMAK1063-12M	1	ATKK16-1926M
-20	J1926-203-32FM	1-5/8-12 UN-2B	1	453H-39	1	J1926-10-C5A	2	TMAK1063-12M	1	ATKK20-1926M
-24	J1926-243-32FM	1-7/8-12 UN-2B	1	453H-45.5	1	J1926-11-C5A	2	TMAK1063-12M	1	ATKK24-1926M
-32	J1926-324-32FM	2-1/2-12 UN-2B	1	454H-61.5	1	J1926-12-C5A	2	TMAK1063-12M	1	ATKK32-1926M

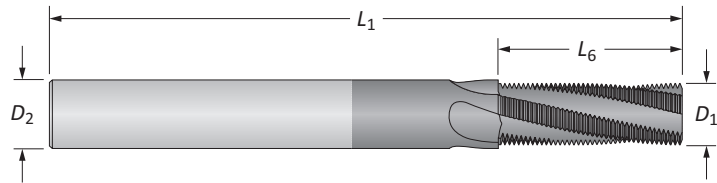

AccuThread™ Port Specific Solid Carbide Thread Mills

Port Size	Pitch	Thread Mill				Flutes	Part No.
		D ₁	L ₆	D ₂	L ₁		
-4 to -5	20	8.51	15.24	10.00	73.00	4	TMAK0438-20M
-6	18	9.40	16.92	10.00	73.00	4	TMAK0563-18M
-8	16	11.94	19.05	12.00	84.00	4	TMAK0750-16M
-10	14	11.94	21.77	12.00	84.00	4	TMAK0875-14M
-12 to -32	12	11.94	23.29	12.00	84.00	4	TMAK1063-12M

AccuPort 432 specific thread mills - International Unified Series (UN) manufactured specifically for use with AccuPort 432 hydraulic port forms. The length of cut allows full thread with one pass. Conforms with J1926 and SAE AS5202 port form specifications.

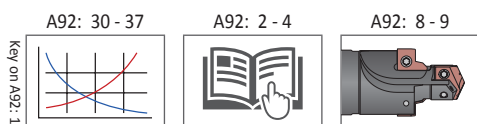

A DRILLING

B BORING

C REAMING

D BURNISHING

F THREADING

X SPECIALS



Port and Thread Finishing Kits

J1926 | Metric | Non-Ferrous Materials

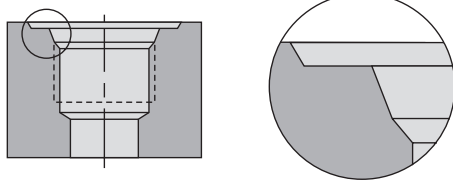

SAE J-1926-1 / ISO 11926-1

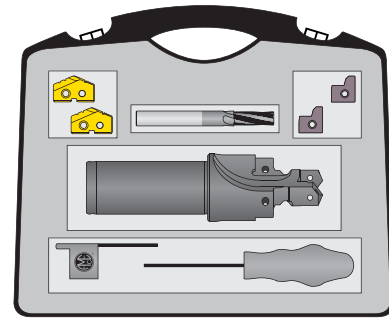

Port and Thread Finishing Kits

Tube Dash No.	AccuPort 432			Original T-A® Insert		Port Form Insert		AccuThread™ Thread Mill		Kit Part No.
	Part No.	Port Thread Size	Qty	Super Cobalt (TiN)	Qty	C5 Carbide (TiAlN)	Qty	Part No. (AM210®)	Qty	
-4	J1926-04Y-16FM	7/16-20 UNF-2B	1	15YT-386	2	J1926-02-C5A	2	TMAU0438-20M	1	ATKU04-1926M
-5	J1926-05Z-16FM	1/2-20 UNF-2B	1	15ZT-11.5	2	J1926-03-C5A	2	TMAU0438-20M	1	ATKU05-1926M
-6	J1926-060-20FM	9/16-18 UNF-2B	1	150T-13	2	J1926-03-C5A	2	TMAU0563-18M	1	ATKU06-1926M
-8	J1926-080-20FM	3/4-16 UNF-2B	1	150T-0022	2	J1926-07-C5A	2	TMAU0750-16M	1	ATKU08-1926M
-10	J1926-101-25FM	7/8-14 UNF-2B	1	151T-20.5	2	J1926-04-C5A	2	TMAU0875-14M	1	ATKU10-1926M
-12	J1926-122-32FM	1-1/16-12 UN-2B	1	152T-25	2	J1926-08-C5A	2	TMAU1063-12M	1	ATKU12-1926M
-14	J1926-142-32FM	1-3/16-12 UN-2B	1	152T-28	2	J1926-08-C5A	2	TMAU1063-12M	1	ATKU14-1926M
-16	J1926-162-32FM	1-5/16-12 UN-2B	1	152T-1.231	2	J1926-09-C5A	2	TMAU1063-12M	1	ATKU16-1926M
-20	J1926-203-32FM	1-5/8-12 UN-2B	1	453T-39	1	J1926-10-C5A	2	TMAU1063-12M	1	ATKU20-1926M
-24	J1926-243-32FM	1-7/8-12 UN-2B	1	453T-45.5	1	J1926-11-C5A	2	TMAU1063-12M	1	ATKU24-1926M
-32	J1926-324-32FM	2-1/2-12 UN-2B	1	454T-61.5	1	J1926-12-C5A	2	TMAU1063-12M	1	ATKU32-1926M

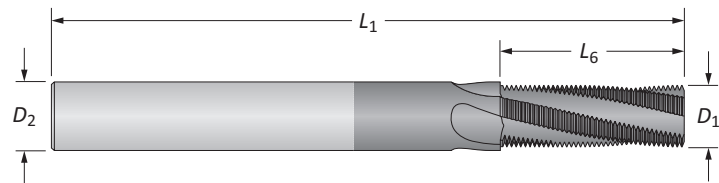

AccuThread™ Port Specific Solid Carbide Thread Mills

Port Size	Pitch	Thread Mill				Flutes	Part No.
		D ₁	L ₆	D ₂	L ₁		
-4 to -5	20	8.51	15.24	10.00	73.00	4	TMAU0438-20M
-6	18	9.40	16.92	10.00	73.00	4	TMAU0563-18M
-8	16	11.94	19.05	12.00	84.00	4	TMAU0750-16M
-10	14	11.94	21.77	12.00	84.00	4	TMAU0875-14M
-12 to -32	12	11.94	23.29	12.00	84.00	4	TMAU1063-12M

AccuPort 432 specific thread mills - International Unified Series (UN) manufactured specifically for use with AccuPort 432 hydraulic port forms. The length of cut allows full thread with one pass. Conforms with J1926 and SAE A5202 port form specifications.

Key on A92-1

A92: 30 - 37

A92: 2 - 4

A92: 8 - 9

J
 A DRILLING
 B BORING
 C REAMING
 D BURNISHING
 E THREADING
 X SPECIALS

Port and Thread Finishing Kits

I6149 | No ID Ridge | Ferrous Materials

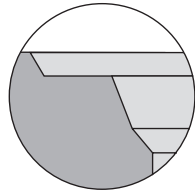
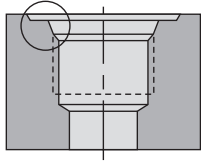

ISO 6149-1:2006 / SAE J-2244/1

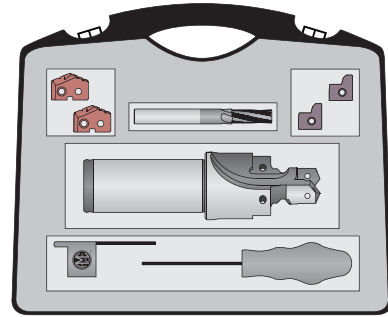

Port and Thread Finishing Kits

Tube Dash No.	AccuPort 432			GEN2 T-A® Insert		Port Form Insert		AccuThread™ Thread Mill		Kit Part No.
	Part No.	Port Thread Size	Qty	Super Cobalt (AM200®)	Qty	C5 Carbide (TiAlN)	Qty	Part No. (AM210®)	Qty	
-4	I6149-04RY-16FM	M12 X 1.5	1	45YH-10.5	2	I6149-04-C5A	2	TMMK1000-150M	1	ATKK04-6149
-5	I6149-05RZ-16FM	M14 X 1.5	1	45ZH-12.5	2	I6149-04-C5A	2	TMMK1400-150M	1	ATKK05-6149
-6	I6149-06RO-20FM	M16 X 1.5	1	45OH-14.5	2	I6149-06-C5A	2	TMMK1400-150M	1	ATKK06-6149
-8	I6149-08RO-20FM	M18 X 1.5	1	45OH-16.5	2	I6149-06-C5A	2	TMMK1800-150M	1	ATKK08-6149
-10	I6149-10R1-25FM	M22 X 1.5	1	451H-20.5	2	I6149-04-C5A	2	TMMK1800-150M	1	ATKK10-6149
-12	I6149-12R2-32FM	M27 X 2	1	452H-25	2	I6149-12-C5A	2	TMMK2000-200M	1	ATKK12-6149
-14	I6149-14R2-32FM	M30 X 2	1	452H-28	2	I6149-14-C5A	2	TMMK2000-200M	1	ATKK14-6149
-16	I6149-16R2-32FM	M33 X 2	1	452H-31	2	I6149-16-C5A	2	TMMK2000-200M	1	ATKK16-6149
-20	I6149-20R3-32FM	M42 X 2	1	453H-40	1	I6149-20-C5A	2	TMMK2000-200M	1	ATKK20-6149
-24	I6149-24R3-32FM	M48 X 2	1	453H-46	1	I6149-24-C5A	2	TMMK2000-200M	1	ATKK24-6149
-32	I6149-32R4-32FM	M60 X 2	1	454H-58	1	I6149-32-C5A	2	TMMK2000-200M	1	ATKK32-6149

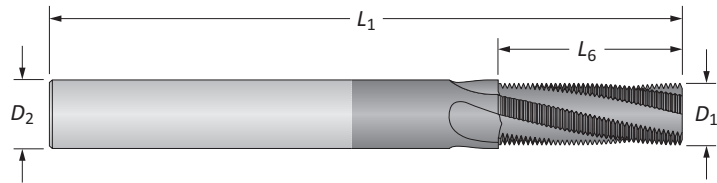

AccuThread™ Port Specific Solid Carbide Thread Mills

Port Size	Pitch	Thread Mill				Flutes	Part No.
		D_1	L_6	D_2	L_1		
-4	1.50	7.40	19.50	8.00	64.00	4	TMMK1000-150M
-5 to -6	1.50	10.90	27.00	12.00	84.00	4	TMMK1400-150M
-8 to -10	1.50	11.90	31.50	12.00	84.00	4	TMMK1800-150M
-12 to -32	2.00	11.95	30.00	12.00	84.00	4	TMMK2000-200M

AccuPort 432 specific thread mills - International Unified Series (UN) manufactured specifically for use with AccuPort 432 hydraulic port forms. The length of cut allows full thread with one pass. Conforms with J1926 and SAE AS5202 port form specifications.

A92: 30 - 37 A92: 2 - 4 A92: 12 - 13



Port and Thread Finishing Kits

I6149 | No ID Ridge | Non-Ferrous Materials

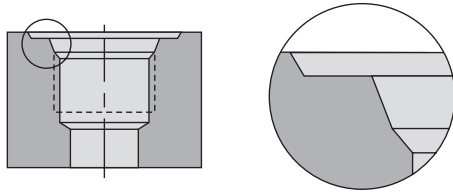

ISO 6149-1:2006 / SAE J-2244/1

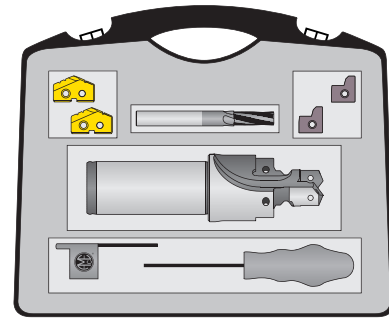

Port and Thread Finishing Kits

Tube Dash No.	AccuPort 432			Original T-A® Insert		Port Form Insert		AccuThread™ Thread Mill		Kit Part No.
	Part No.	Port Thread Size	Qty	Super Cobalt (TiN)	Qty	C5 Carbide (TiAlN)	Qty	Part No. (AM210®)	Qty	
-4	I6149-04RY-16FM	M12 X 1.5	1	15YT-10.5	2	I6149-04-C5A	2	TMMU1000-150M	1	ATKU04-6149
-5	I6149-05RZ-16FM	M14 X 1.5	1	15ZT-12.5	2	I6149-04-C5A	2	TMMU1400-150M	1	ATKU05-6149
-6	I6149-06R0-20FM	M16 X 1.5	1	150T-14.5	2	I6149-06-C5A	2	TMMU1400-150M	1	ATKU06-6149
-8	I6149-08R0-20FM	M18 X 1.5	1	150T-16.5	2	I6149-06-C5A	2	TMMU1800-150M	1	ATKU08-6149
-10	I6149-10R1-25FM	M22 X 1.5	1	151T-20.5	2	I6149-04-C5A	2	TMMU1800-150M	1	ATKU10-6149
-12	I6149-12R2-32FM	M27 X 2	1	152T-25	2	I6149-12-C5A	2	TMMU2000-200M	1	ATKU12-6149
-14	I6149-14R2-32FM	M30 X 2	1	152T-28	2	I6149-14-C5A	2	TMMU2000-200M	1	ATKU14-6149
-16	I6149-16R2-32FM	M33 X 2	1	152T-31	2	I6149-16-C5A	2	TMMU2000-200M	1	ATKU16-6149
-20	I6149-20R3-32FM	M42 X 2	1	453T-40	1	I6149-20-C5A	2	TMMU2000-200M	1	ATKU20-6149
-24	I6149-24R3-32FM	M48 X 2	1	453T-46	1	I6149-24-C5A	2	TMMU2000-200M	1	ATKU24-6149
-32	I6149-32R4-32FM	M60 X 2	1	454T-58	1	I6149-32-C5A	2	TMMU2000-200M	1	ATKU32-6149

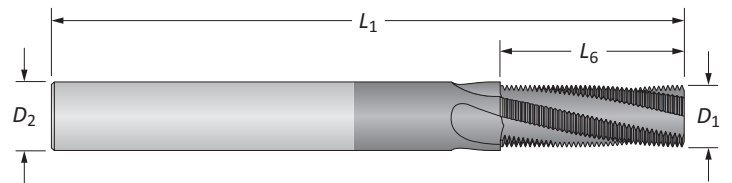

AccuThread™ Port Specific Solid Carbide Thread Mills

Port Size	Pitch	Thread Mill				Flutes	Part No.
		D ₁	L ₆	D ₂	L ₁		
-4	1.50	7.40	19.50	8.00	64.00	4	TMMU1000-150M
-5 to -6	1.50	10.90	27.00	12.00	84.00	4	TMMU1400-150M
-8 to -10	1.50	11.90	31.50	12.00	84.00	4	TMMU1800-150M
-12 to -32	2.00	11.95	30.00	12.00	84.00	4	TMMU2000-200M

AccuPort 432 specific thread mills - International Unified Series (UN) manufactured specifically for use with AccuPort 432 hydraulic port forms. The length of cut allows full thread with one pass. Conforms with J1926 and SAE A5202 port form specifications.

Key on A92-1

A92: 30 - 37

A92: 2 - 4

A92: 12 - 13

I
 A
 DRILLING
 B
 BORING
 C
 REAMING
 D
 BURNISHING
 E
 THREADING
 X
 SPECIALS

Port and Thread Finishing Kits

I6149 | ID Ridge | Ferrous Materials

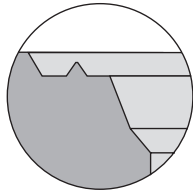
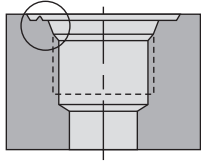

ISO 6149-1:2006 / SAE J-2244/1

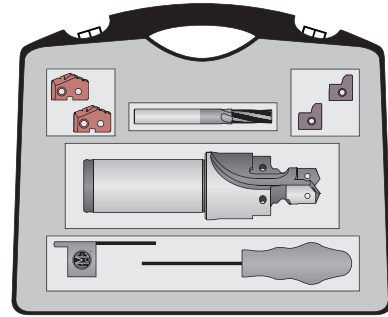

Port and Thread Finishing Kits

Tube Dash No.	AccuPort 432			GEN2 T-A® Insert		Port Form Insert		AccuThread™ Thread Mill		Kit Part No.
	Part No.	Port Thread Size	Qty	Super Cobalt (AM200®)	Qty	C5 Carbide (TiAlN)	Qty	Part No. (AM210®)	Qty	
-4	I6149-04RY-16FM	M12 X 1.5	1	45YH-10.5	2	I6149-04R-C5A	2	TMMK1000-150M	1	ATKK04R-6149
-5	I6149-05RZ-16FM	M14 X 1.5	1	45ZH-12.5	2	I6149-04R-C5A	2	TMMK1400-150M	1	ATKK05R-6149
-6	I6149-06RO-20FM	M16 X 1.5	1	45OH-14.5	2	I6149-06R-C5A	2	TMMK1400-150M	1	ATKK06R-6149
-8	I6149-08RO-20FM	M18 X 1.5	1	45OH-16.5	2	I6149-06R-C5A	2	TMMK1800-150M	1	ATKK08R-6149
-10	I6149-10R1-25FM	M22 X 1.5	1	451H-20.5	2	I6149-04R-C5A	2	TMMK1800-150M	1	ATKK10R-6149
-12	I6149-12R2-32FM	M27 X 2	1	452H-25	2	I6149-12R-C5A	2	TMMK2000-200M	1	ATKK12R-6149
-14	I6149-14R2-32FM	M30 X 2	1	452H-28	2	I6149-14R-C5A	2	TMMK2000-200M	1	ATKK14R-6149
-16	I6149-16R2-32FM	M33 X 2	1	452H-31	2	I6149-16R-C5A	2	TMMK2000-200M	1	ATKK16R-6149
-20	I6149-20R3-32FM	M42 X 2	1	453H-40	1	I6149-20R-C5A	2	TMMK2000-200M	1	ATKK20R-6149
-24	I6149-24R3-32FM	M48 X 2	1	453H-46	1	I6149-24R-C5A	2	TMMK2000-200M	1	ATKK24R-6149
-32	I6149-32R4-32FM	M60 X 2	1	454H-58	1	I6149-32R-C5A	2	TMMK2000-200M	1	ATKK32R-6149

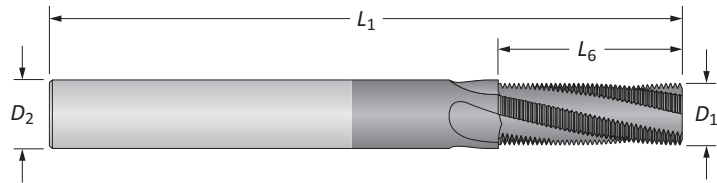

AccuThread™ Port Specific Solid Carbide Thread Mills

Port Size	Pitch	Thread Mill				Flutes	Part No.
		D_1	L_6	D_2	L_1		
-4	1.50	7.40	19.50	8.00	64.00	4	TMMK1000-150M
-5 to -6	1.50	10.90	27.00	12.00	84.00	4	TMMK1400-150M
-8 to -10	1.50	11.90	31.50	12.00	84.00	4	TMMK1800-150M
-12 to -32	2.00	11.95	30.00	12.00	84.00	4	TMMK2000-200M

AccuPort 432 specific thread mills - International Unified Series (UN) manufactured specifically for use with AccuPort 432 hydraulic port forms. The length of cut allows full thread with one pass. Conforms with J1926 and SAE AS5202 port form specifications.

A92: 30 - 37 A92: 2 - 4 A92: 12 - 13



Port and Thread Finishing Kits

I6149 | ID Ridge | Non-Ferrous Materials

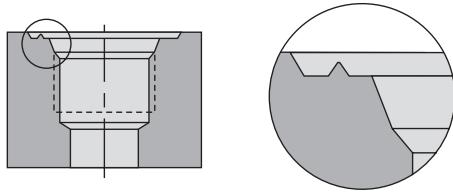

ISO 6149-1:2006 / SAE J-2244/1

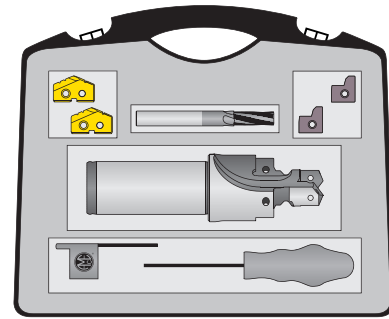

Port and Thread Finishing Kits

Tube Dash No.	AccuPort 432			Original T-A® Insert		Port Form Insert		AccuThread™ Thread Mill		Kit Part No.
	Part No.	Port Thread Size	Qty	Super Cobalt (TiN)	Qty	C5 Carbide (TiAlN)	Qty	Part No. (AM210®)	Qty	
-4	I6149-04RY-16FM	M12 X 1.5	1	15YT-10.5	2	I6149-04R-C5A	2	TMMU1000-150M	1	ATKU04R-6149
-5	I6149-05RZ-16FM	M14 X 1.5	1	15ZT-12.5	2	I6149-04R-C5A	2	TMMU1400-150M	1	ATKU05R-6149
-6	I6149-06R0-20FM	M16 X 1.5	1	150T-14.5	2	I6149-06R-C5A	2	TMMU1400-150M	1	ATKU06R-6149
-8	I6149-08R0-20FM	M18 X 1.5	1	150T-16.5	2	I6149-06R-C5A	2	TMMU1800-150M	1	ATKU08R-6149
-10	I6149-10R1-25FM	M22 X 1.5	1	151T-20.5	2	I6149-04R-C5A	2	TMMU1800-150M	1	ATKU10R-6149
-12	I6149-12R2-32FM	M27 X 2	1	152T-25	2	I6149-12R-C5A	2	TMMU2000-200M	1	ATKU12R-6149
-14	I6149-14R2-32FM	M30 X 2	1	152T-28	2	I6149-14R-C5A	2	TMMU2000-200M	1	ATKU14R-6149
-16	I6149-16R2-32FM	M33 X 2	1	152T-31	2	I6149-16R-C5A	2	TMMU2000-200M	1	ATKU16R-6149
-20	I6149-20R3-32FM	M42 X 2	1	453T-40	1	I6149-20R-C5A	2	TMMU2000-200M	1	ATKU20R-6149
-24	I6149-24R3-32FM	M48 X 2	1	453T-46	1	I6149-24R-C5A	2	TMMU2000-200M	1	ATKU24R-6149
-32	I6149-32R4-32FM	M60 X 2	1	454T-58	1	I6149-32R-C5A	2	TMMU2000-200M	1	ATKU32R-6149

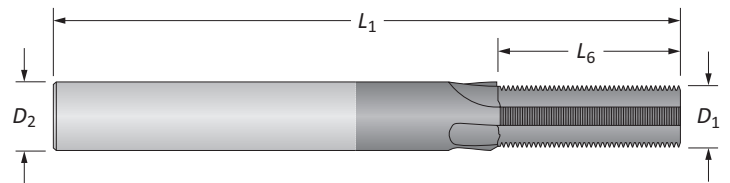

AccuThread™ Port Specific Solid Carbide Thread Mills

Port Size	Pitch	Thread Mill				Flutes	Part No.
		D ₁	L ₆	D ₂	L ₁		
-4	1.50	7.40	19.50	8.00	64.00	4	TMMU1000-150M
-5 to -6	1.50	10.90	27.00	12.00	84.00	4	TMMU1400-150M
-8 to -10	1.50	11.90	31.50	12.00	84.00	4	TMMU1800-150M
-12 to -32	2.00	11.95	30.00	12.00	84.00	4	TMMU2000-200M

AccuPort 432 specific thread mills - International Unified Series (UN) manufactured specifically for use with AccuPort 432 hydraulic port forms. The length of cut allows full thread with one pass. Conforms with J1926 and SAE A5202 port form specifications.

Key on A92-1

A92: 30 - 37

A92: 2 - 4

A92: 12 - 13

I
 A
 DRILLING
 B
 BORING
 C
 REAMING
 D
 BURNISHING
 E
 THREADING
 X
 SPECIALS

Port and Thread Finishing Kits

AS5202 | Ferrous Materials

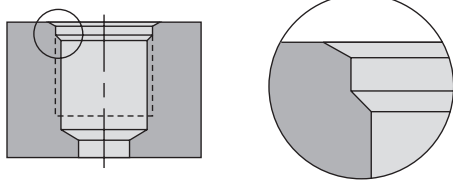

SAE AS5202

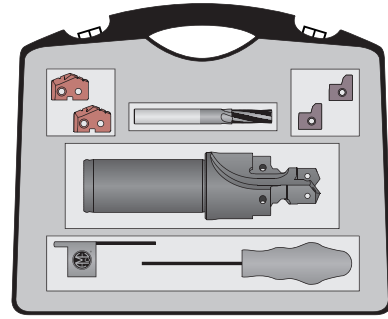

Port and Thread Finishing Kits

Tube Dash No.	AccuPort 432			GEN2 T-A® Insert		Port Form Insert		AccuThread™ Thread Mill		Kit Part No.
	Part No.	Port Thread Size	Qty	Super Cobalt (AM200®)	Qty	C5 Carbide (TiAlN)	Qty	Part No. (AM210®)	Qty	
-4	AS5202-04Y-063F	7/16-20 UNJF-3B	1	45YH-.390	2	AS5202-04-C5A	2	TMAK0438-20	1	ATKK04-5202
-5	AS5202-05Z-063F	1/2-20 UNJF-3B	1	45ZH-11.5	2	AS5202-05-C5A	2	TMAK0438-20	1	ATKK05-5202
-6	AS5202-06Z-075F	9/16-18 UNJF-3B	1	45ZH-.510	2	AS5202-06-C5A	2	TMAK0563-18	1	ATKK06-5202
-8	AS5202-080-075F	3/4-16 UNJF-3B	1	450H-17.5	2	AS5202-08-C5A	2	TMAK0750-16	1	ATKK08-5202
-10	AS5202-101-100F	7/8-14 UNJF-3B	1	451H-20.5	2	AS5202-10-C5A	2	TMAK0875-14	1	ATKK10-5202
-12	AS5202-122-125F	1-1/16-12 UNJ-3B	1	452H-25	2	AS5202-12-C5A	2	TMAK1063-12	1	ATKK12-5202
-14	AS5202-142-125F	1-3/16-12 UNJ-3B	1	452H-1.109	2	AS5202-14-C5A	2	TMAK1063-12	1	ATKK14-5202
-16	AS5202-162-125F	1-5/16-12 UNJ-3B	1	452H-1.234	2	AS5202-16-C5A	2	TMAK1063-12	1	ATKK16-5202
-20	AS5202-203-150F	1-5/8-12 UNJ-3B	1	453H-1.547	1	AS5202-20-C5A	2	TMAK1063-12	1	ATKK20-5202
-24	AS5202-243-150F	1-7/8-12 UNJ-3B	1	453H-1.797	1	AS5202-24-C5A	2	TMAK1063-12	1	ATKK24-5202
-32	AS5202-324-150F	2-1/2-12 UNJ-3B	1	454H-61.5	1	AS5202-32-C5A	2	TMAK1063-12	1	ATKK32-5202

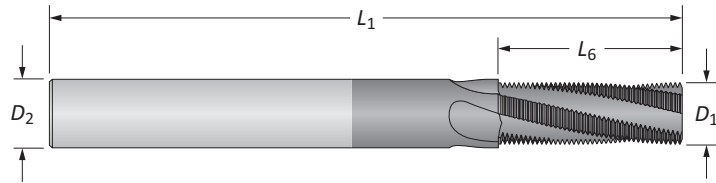

AccuThread™ Port Specific Solid Carbide Thread Mills

Port Size	Pitch	Thread Mill				Flutes	Part No.
		D ₁	L ₆	D ₂	L ₁		
-4 to -5	20	0.335	0.600	0.375	3.5	4	TMAK0438-20
-6	18	0.370	0.666	0.375	3.5	4	TMAK0563-18
-8	16	0.495	0.750	0.500	3.5	4	TMAK0750-16
-10	14	0.495	0.857	0.500	3.5	4	TMAK0875-14
-12 to -32	12	0.495	0.917	0.500	3.5	4	TMAK1063-12

AccuPort 432 specific thread mills - International Unified Series (UN) manufactured specifically for use with AccuPort 432 hydraulic port forms. The length of cut allows full thread with one pass. Conforms with J1926 and SAE AS5202 port form specifications.

A92: 30 - 37 A92: 2 - 4 A92: 14 - 15

A
DRILLING
BORING
REAMING
BURNISHING
THREADING
SPECIALS



Port and Thread Finishing Kits

AS5202 | Non-Ferrous Materials

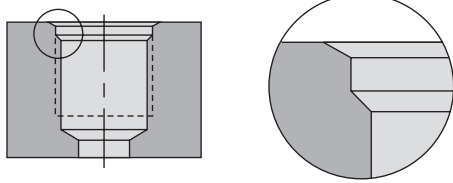

SAE AS5202

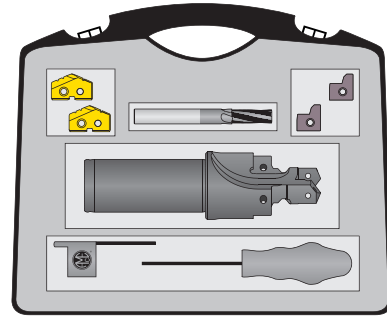

Port and Thread Finishing Kits

Tube Dash No.	AccuPort 432			Original T-A® Insert		Port Form Insert		AccuThread™ Thread Mill		Kit Part No.
	Part No.	Port Thread Size	Qty	Super Cobalt (TiN)	Qty	C5 Carbide (TiAlN)	Qty	Part No. (AM210®)	Qty	
-4	AS5202-04Y-063F	7/16-20 UNJF-3B	1	15YT-.390	2	AS5202-04-C5A	2	TMAU0438-20	1	ATKU04-5202
-5	AS5202-05Z-063F	1/2-20 UNJF-3B	1	15ZT-11.5	2	AS5202-05-C5A	2	TMAU0438-20	1	ATKU05-5202
-6	AS5202-06Z-075F	9/16-18 UNJF-3B	1	15ZT-.510	2	AS5202-06-C5A	2	TMAU0563-18	1	ATKU06-5202
-8	AS5202-080-075F	3/4-16 UNJF-3B	1	150T-17.5	2	AS5202-08-C5A	2	TMAU0750-16	1	ATKU08-5202
-10	AS5202-101-100F	7/8-14 UNJF-3B	1	151T-20.5	2	AS5202-10-C5A	2	TMAU0875-14	1	ATKU10-5202
-12	AS5202-122-125F	1-1/16-12 UNJ-3B	1	152T-25	2	AS5202-12-C5A	2	TMAU1063-12	1	ATKU12-5202
-14	AS5202-142-125F	1-3/16-12 UNJ-3B	1	152T-1.109	2	AS5202-14-C5A	2	TMAU1063-12	1	ATKU14-5202
-16	AS5202-162-125F	1-5/16-12 UNJ-3B	1	152T-1.234	2	AS5202-16-C5A	2	TMAU1063-12	1	ATKU16-5202
-20	AS5202-203-150F	1-5/8-12 UNJ-3B	1	453T-1.547	1	AS5202-20-C5A	2	TMAU1063-12	1	ATKU20-5202
-24	AS5202-243-150F	1-7/8-12 UNJ-3B	1	453T-1.797	1	AS5202-24-C5A	2	TMAU1063-12	1	ATKU24-5202
-32	AS5202-324-150F	2-1/2-12 UNJ-3B	1	454T-61.5	1	AS5202-32-C5A	2	TMAU1063-12	1	ATKU32-5202

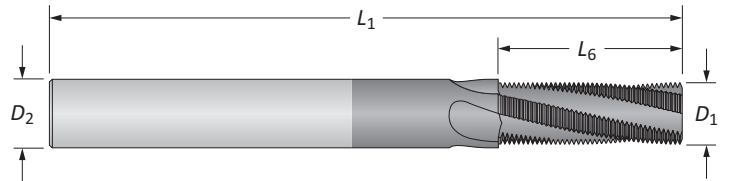

AccuThread™ Port Specific Solid Carbide Thread Mills

Port Size	Pitch	Thread Mill				Flutes	Part No.
		D ₁	L ₆	D ₂	L ₁		
-4 to -5	20	0.335	0.600	0.375	3.5	4	TMAU0438-20
-6	18	0.370	0.666	0.375	3.5	4	TMAU0563-18
-8	16	0.495	0.750	0.500	3.5	4	TMAU0750-16
-10	14	0.495	0.857	0.500	3.5	4	TMAU0875-14
-12 to -32	12	0.495	0.917	0.500	3.5	4	TMAU1063-12

AccuPort 432 specific thread mills - International Unified Series (UN) manufactured specifically for use with AccuPort 432 hydraulic port forms. The length of cut allows full thread with one pass. Conforms with J1926 and SAE AS5202 port form specifications.

A92: 30 - 37

A92: 2 - 4

A92: 14 - 15

Key on A92: 1

Port and Thread Finishing Kits

G1731 | Ferrous Materials

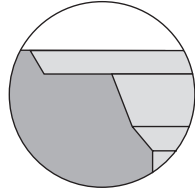
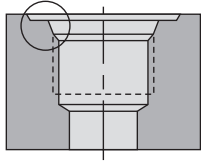

JDS-G173.1

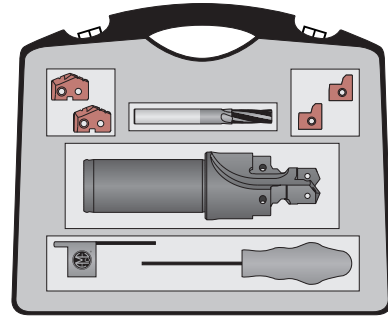

Port and Thread Finishing Kits

Tube Dash No.	AccuPort 432			GEN2 T-A® Insert		Port Form Insert		AccuThread™ Thread Mill		Kit Part No.
	Part No.	Port Thread Size	Qty	Super Cobalt (AM200®)	Qty	C3 Carbide (AM200®)	Qty	Part No. (AM210®)	Qty	
-4	G1731-04Y-16FM	M12 X 1.5	1	45YH-10.5	2	G1731-01-C3H	2	TMMK1000-150M	1	ATKK04-G1731
-5	G1731-05Z-16FM	M14 X 1.5	1	45ZH-12.5	2	G1731-01-C3H	2	TMMK1400-150M	1	ATKK05-G1731
-6	G1731-060-20FM	M16 X 1.5	1	450H-14.5	2	G1731-02-C3H	2	TMMK1400-150M	1	ATKK06-G1731
-8	G1731-080-20FM	M18 X 1.5	1	450H-16.5	2	G1731-02-C3H	2	TMMK1800-150M	1	ATKK08-G1731
-10	G1731-101-25FM	M22 X 1.5	1	451H-20.5	2	G1731-02-C3H	2	TMMK1800-150M	1	ATKK10-G1731
-12	G1731-122-32FM	M27 X 2	1	452H-25	2	G1731-03-C3H	2	TMMK2000-200M	1	ATKK12-G1731
-14	G1731-142-32FM	M30 X 2	1	452H-28	2	G1731-03-C3H	2	TMMK2000-200M	1	ATKK14-G1731
-16	G1731-162-32FM	M33 X 2	1	452H-31	2	G1731-04-C3H	2	TMMK2000-200M	1	ATKK16-G1731
-18	G1731-183-32FM	M38 X 2	1	453H-36	1	G1731-04-C3H	2	TMMK2000-200M	2	ATKK18-G1731
-20	G1731-203-32FM	M42 X 2	1	453H-40	1	G1731-05-C3H	2	TMMK2000-200M	1	ATKK20-G1731
-24	G1731-243-32FM	M48 X 2	1	453H-46	1	G1731-05-C3H	2	TMMK2000-200M	1	ATKK24-G1731
-32	G1731-324-32FM	M60 X 2	1	454H-58	1	G1731-06-C3H	2	TMMK2000-200M	1	ATKK32-G1731

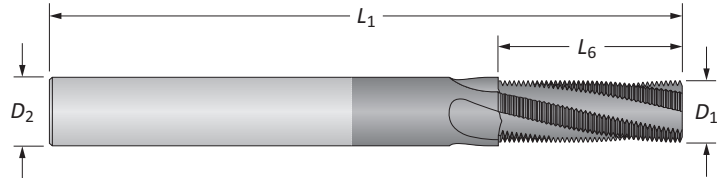

AccuThread™ Port Specific Solid Carbide Thread Mills

Port Size	Pitch	Thread Mill				Flutes	Part No.
		D_1	L_6	D_2	L_1		
-4	1.50	7.40	19.50	8.00	64.00	4	TMMK1000-150M
-5 to -6	1.50	10.90	27.00	12.00	84.00	4	TMMK1400-150M
-8 to -10	1.50	11.90	31.50	12.00	84.00	4	TMMK1800-150M
-12 to -32	2.00	11.95	30.00	12.00	84.00	4	TMMK2000-200M

AccuPort 432 specific thread mills - International Unified Series (UN) manufactured specifically for use with AccuPort 432 hydraulic port forms. The length of cut allows full thread with one pass. Conforms with J1926 and SAE AS5202 port form specifications.

A92: 30 - 37 A92: 2 - 4 A92: 16 - 17

Key on A92: 1

This page left intentionally blank

A

DRILLING

B

BORING

C

REAMING

D

BURNISHING

E

THREADING

X

SPECIALS

Recommended Drilling Data | Imperial (inch)

HSS

ISO	Material	Hardness (BHN)	Grade	Speed (SFM)				Feed Rate (IPR) by Tube Size and T-A® Insert Series					
				TiN	TiAlN	TiCN	AM200®	Tube No. 4 - 5	Tube No. 6 - 8	Tube No. 10	Tube No. 12 - 16	Tube No. 20 - 24	Tube No. 32
								T-A Series Y - Z	T-A Series 0	T-A Series 1	T-A Series 2	T-A Series 3	T-A Series 4
P	Free Machining Steel 1118, 1215, 12L14, etc.	100 - 150	HSS	200	280	260	325	0.007	0.010	0.013	0.016	0.020	0.023
		150 - 200	HSS	180	260	235	300	0.007	0.010	0.013	0.016	0.020	0.023
		200 - 250	HSS	160	240	210	280	0.006	0.010	0.013	0.016	0.020	0.023
	Low Carbon Steel 1010, 1020, 1025, 1522, 1144, etc.	85 - 125	HSS	170	250	220	290	0.006 ❖	0.009	0.012	0.015	0.019	0.023
		125 - 175	HSS	160	240	210	275	0.006 ❖	0.009	0.012	0.015	0.019	0.023
		175 - 225	HSS	150	225	195	260	0.005 ❖	0.008	0.010	0.014	0.018	0.021
	Medium Carbon Steel 1030, 1040, 1050, 1527, 1140, 1151, etc.	125 - 175	HSS	160	240	210	275	0.006	0.009	0.012	0.015	0.019	0.023
		175 - 225	HSS	150	225	195	260	0.005	0.008	0.010	0.014	0.018	0.021
		225 - 275	HSS	140	210	180	240	0.005	0.008	0.010	0.014	0.018	0.021
	Alloy Steel 4140, 5140, 8640, etc.	125 - 175	HSS	150	210	195	240	0.006	0.008	0.010	0.014	0.017	0.019
		175 - 225	HSS	140	195	180	225	0.005	0.008	0.010	0.014	0.017	0.019
		225 - 275	HSS	130	180	170	210	0.005	0.007	0.010	0.014	0.017	0.019
		275 - 325	SC	120	170	155	195	0.004	0.006	0.009	0.012	0.015	0.017
	High Strength Alloy 4340, 4330V, 300M, etc.	325 - 375	SC	110	155	145	180	0.003	0.006	0.009	0.012	0.015	0.017
		225 - 300	SC	80	110	100	125	0.005 ❖	0.007	0.009	0.010	0.014	0.017
		300 - 350	SC	60	85	80	100	0.004 ❖	0.007	0.009	0.010	0.014	0.017
	Structural Steel A36, A285, A516, etc.	350 - 400	SC	50	70	65	80	0.003 ❖	0.006	0.008	0.009	0.012	0.015
		100 - 150	HSS	140	200	180	235	0.006 ❖	0.010	0.012	0.014	0.018	0.021
150 - 250		HSS	120	170	155	190	0.005 ❖	0.009	0.010	0.012	0.016	0.019	
Tool Steel H-13, H-21, A-4, O-2, S-3, etc.	250 - 350	SC	100	140	130	160	0.004 ❖	0.009	0.009	0.010	0.014	0.017	
	150 - 200	SC	80	110	105	125	0.004 ❖	0.006	0.008	0.010	0.014	0.015	
S	High Temp Alloy Hastelloy B, Inconel 600, etc.	200 - 250	SC	60	90	85	105	0.004 ❖	0.006	0.008	0.010	0.012	0.015
		140 - 220	SC	30	40	35	45	0.003 ❖	0.007	0.008	0.010	0.012	0.015
M	Stainless Steel 400 Series 416, 420, 303, etc.	220 - 310	SC	25	35	30	40	0.003 ❖	0.006	0.007	0.008	0.010	0.012
		185 - 275	SC	75	105	95	110	0.006 ❖	0.008	0.009	0.011	0.012	0.016
K	Nodular, Grey, Ductile Cast Iron	275 - 350	SC	60	90	80	100	0.005 ❖	0.007	0.008	0.010	0.012	0.014
		120 - 150	HSS	170	250	220	290	0.007	0.012	0.016	0.020	0.024	0.027
		150 - 200	HSS	150	225	195	260	0.006	0.011	0.014	0.018	0.022	0.025
		200 - 220	HSS	130	195	170	225	0.006	0.009	0.012	0.016	0.018	0.021
		220 - 260	SC	110	165	145	190	0.005	0.007	0.009	0.012	0.014	0.017
260 - 320	SC	90	135	120	155	0.004	0.006	0.007	0.009	0.012	0.014		
N	Aluminum	30	HSS	600	850	750	-	0.008	0.013	0.016	0.020	0.022	0.025
		180	HSS	300	450	400	-	0.008	0.013	0.016	0.018	0.022	0.025

Formulas

<p>1. RPM = (3.82 • SFM) / DIA</p> <p>where:</p> <p>RPM = revolutions per minute (rev/min)</p> <p>SFM = speed (ft/min)</p> <p>DIA = finish diameter of drill (inch)</p>	<p>2. SFM = RPM • 0.262 • DIA</p> <p>where:</p> <p>SFM = speed (ft/min)</p> <p>RPM = revolutions per minute (rev/min)</p> <p>DIA = diameter of drill (inch)</p>	<p>3. IPM = RPM • IPR</p> <p>where:</p> <p>IPM = Feed rate</p> <p>RPM = revolutions per minute (rev/min)</p> <p>IPR = feed rate (in/rev)</p>
--	--	---

The table and equations on this page are found in the *Machinery's Handbook*. Permission to simplify and print the equations is granted by the Editor of the *Machinery's Handbook*.

IMPORTANT: The speeds and feeds listed above are a general starting point for all applications. Refer to the Coolant Recommendation charts for coolant requirements to run at the recommended speeds and feeds. Factory technical assistance is also available through our Application Engineering Team. Due to potential chip formation issues, contact our Application Engineering Team for assistance machining materials marked with a ❖.

Coolant Recommendations | Imperial (inch)

HSS

ISO	Material	Pressure / Flow Rate	Tube No. 4 - 5	Tube No. 6 - 8	Tube No. 10	Tube No. 12 - 16	Tube No. 20 - 24	Tube No. 32
			T-A Series Y - Z	T-A Series 0	T-A Series 1	T-A Series 2	T-A Series 3	T-A Series 4
P	Free Machining Steel 1118, 1215, 12L14, etc.	PSI	175 - 185	100 - 120	105 - 140	80 - 115	75 - 100	40 - 50
		GPM	2.5 - 2.6	2.8 - 3.0	4.4 - 5.2	7 - 8	12 - 14	30 - 33
	Low Carbon Steel 1010, 1020, 1025, 1522, 1144, etc.	PSI	165 - 170	75 - 90	75 - 95	60 - 80	55 - 75	30 - 40
		GPM	2.4 - 2.5	2.4 - 2.6	3.7 - 4.2	6 - 7	11 - 12	26 - 30
	Medium Carbon Steel 1030, 1040, 1050, 1527, 1140, 1151, etc.	PSI	160 - 165	70 - 85	70 - 90	55 - 75	50 - 70	30 - 40
		GPM	2.3 - 2.4	2.3 - 2.6	3.7 - 4.2	5 - 6	10 - 12	26 - 30
	Alloy Steel 4140, 5140, 8640, etc.	PSI	160 - 165	65 - 75	65 - 80	50 - 70	45 - 60	30 - 35
		GPM	2.3 - 2.4	2.2 - 2.4	3.5 - 3.9	5 - 6	10 - 11	26 - 28
	High Strength Alloy 4340, 4330V, 300M, etc.	PSI	150 - 155	55 - 60	45 - 50	25 - 30	25 - 30	20 - 25
		GPM	2.3 - 2.4	2.1 - 2.2	2.9 - 3.1	4 - 5	7 - 8	21 - 23
	Structural Steel A36, A285, A516, etc.	PSI	160 - 165	75 - 85	65 - 80	40 - 55	40 - 50	25 - 30
		GPM	2.3 - 2.4	2.4 - 2.6	3.5 - 3.9	5 - 6	9 - 10	23 - 26
	Tool Steel H-13, H-21, A-4, O-2, S-3, etc.	PSI	150 - 155	55 - 60	45 - 50	25 - 30	25 - 30	20 - 25
		GPM	2.3 - 2.4	2.1 - 2.2	2.9 - 3.1	4 - 5	7 - 8	21 - 23
S	High Temp Alloy Hastelloy B, Inconel 600, etc.	PSI	150 - 155	60 - 65	50 - 55	30 - 35	25 - 30	25 - 30
		GPM	2.3 - 2.4	2.2 - 2.3	3.1 - 3.2	4 - 5	7 - 8	23 - 26
M	Stainless Steel 400 Series 416, 420, 303, etc.	PSI	171	86	75	55	51	29
		GPM	3	3	4	6	10	26
K	Nodular, Grey, Ductile Cast Iron	PSI	160	65	61	41	35	29
		GPM	2	2	3	5	9	26
N	Aluminum	PSI	210	180	230	159	125	51
		GPM	3	4	6	9	16	33

IMPORTANT: The coolant pressure and flow rate recommendations above represent a good approximation to obtain optimum tool life and chip evacuation at Allied's recommended speeds and feeds. If lower coolant capabilities exist in a drilling application, the AccuPort 432 Port Contour Cutter will still function at reduced penetration rates. Contact our Application Engineering Department for a more specific recommendation of coolant requirements and/or speeds and feeds.

A
DRILLING
B
BORING
C
REAMING
D
BURNISHING
E
THREADING
X
SPECIALS

Recommended Drilling Data | Imperial (inch)

Carbide

ISO	Material	Hardness (BHN)	Grade	Speed (SFM)			Feed Rate (IPR) by Tube Size and T-A® Insert Series				
				TiN	TiAlN	AM200®	Tube No. 4 - 5	Tube No. 6 - 8	Tube No. 10	Tube No. 12 - 16	Tube No. 20 - 24
							T-A Series Y - Z	T-A Series 0	T-A Series 1	T-A Series 2	T-A Series 3
P	Free Machining Steel 1118, 1215, 12L14, etc.	100 - 150	C1, C5	320	420	480	0.008	0.012	0.015	0.018	0.021
		150 - 200	C1, C5	280	360	415	0.007	0.011	0.014	0.016	0.019
		200 - 250	C1, C5	260	340	390	0.006	0.010	0.013	0.015	0.017
	Low Carbon Steel 1010, 1020, 1025, 1522, 1144, etc.	85 - 125	C1, C5	300	390	450	0.008 ❖	0.010	0.013	0.017	0.019
		125 - 175	C1, C5	260	340	390	0.007 ❖	0.010	0.013	0.016	0.018
		175 - 225	C1, C5	240	310	355	0.006 ❖	0.009	0.012	0.015	0.017
		225 - 275	C1, C5	210	270	310	0.005 ❖	0.009	0.012	0.015	0.017
	Medium Carbon Steel 1030, 1040, 1050, 1527, 1140, 1151, etc.	125 - 175	C1, C5	260	340	390	0.007	0.010	0.013	0.016	0.018
		175 - 225	C1, C5	240	310	355	0.006	0.009	0.012	0.015	0.017
		225 - 275	C1, C5	210	270	310	0.006	0.009	0.012	0.015	0.017
		275 - 325	C1, C5	180	230	265	0.005	0.008	0.011	0.014	0.016
	Alloy Steel 4140, 5140, 8640, etc.	125 - 175	C1, C5	250	325	375	0.007	0.010	0.013	0.016	0.018
		175 - 225	C1, C5	230	300	345	0.006	0.009	0.012	0.015	0.017
		225 - 275	C1, C5	210	270	310	0.006	0.009	0.012	0.015	0.017
		275 - 325	C1, C5	200	250	285	0.005	0.008	0.011	0.014	0.016
		325 - 375	C1, C5	170	220	255	0.004	0.007	0.010	0.013	0.015
	High Strength Alloy 4340, 4330V, 300M, etc.	225 - 300	C1, C5	160	200	230	0.006 ❖	0.009	0.010	0.012	0.015
		300 - 350	C1, C5	140	180	205	0.005 ❖	0.008	0.009	0.011	0.014
		350 - 400	C1, C5	120	160	185	0.004 ❖	0.007	0.008	0.010	0.012
	Structural Steel A36, A285, A516, etc.	100 - 150	C1, C5	240	310	355	0.008 ❖	0.011	0.014	0.016	0.018
150 - 250		C1, C5	200	250	285	0.006 ❖	0.010	0.012	0.014	0.016	
250 - 350		C1, C5	180	230	265	0.005 ❖	0.009	0.011	0.012	0.014	
Tool Steel H-13, H-21, A-4, O-2, S-3, etc.	150 - 200	C1, C5	160	220	255	0.004 ❖	0.007	0.009	0.011	0.013	
	200 - 250	C1, C5	120	170	195	0.004 ❖	0.007	0.009	0.011	0.013	
S	High Temp Alloy Hastelloy B, Inconel 600, etc.	140 - 220	C2	80	105	120	0.004 ❖	0.007	0.009	0.011	0.013
		220 - 310	C2	60	85	95	0.004 ❖	0.006	0.008	0.010	0.012
M	Stainless Steel 400 Series 416, 420, 303, etc.	185 - 275	C2	160	210	240	0.007 ❖	0.009	0.012	0.014	0.016
		275 - 350	C2	120	160	185	0.006 ❖	0.008	0.011	0.012	0.014
K	Nodular, Grey, Ductile Cast Iron	120 - 150	C2, C3	320	460	500	0.008	0.012	0.015	0.019	0.023
		150 - 200	C2, C3	270	400	480	0.007	0.011	0.013	0.017	0.021
		200 - 220	C2, C3	240	360	430	0.006	0.009	0.012	0.015	0.018
		220 - 260	C2, C3	210	310	370	0.005	0.008	0.011	0.013	0.015
		260 - 320	C2, C3	180	270	335	0.005	0.007	0.010	0.011	0.013
N	Aluminum	30	C2	1200	1500	-	0.010	0.015	0.018	0.020	0.022
		180	C2	800	1000	-	0.009	0.013	0.016	0.018	0.020

Formulas

<p>1. RPM = (3.82 • SFM) / DIA</p> <p>where:</p> <p>RPM = revolutions per minute (rev/min)</p> <p>SFM = speed (ft/min)</p> <p>DIA = finish diameter of drill (inch)</p>	<p>2. SFM = RPM • 0.262 • DIA</p> <p>where:</p> <p>SFM = speed (ft/min)</p> <p>RPM = revolutions per minute (rev/min)</p> <p>DIA = diameter of drill (inch)</p>	<p>3. IPM = RPM • IPR</p> <p>where:</p> <p>IPM = Feed rate</p> <p>RPM = revolutions per minute (rev/min)</p> <p>IPR = feed rate (in/rev)</p>
--	--	---

The table and equations on this page are found in the *Machinery's Handbook*. Permission to simplify and print the equations is granted by the Editor of the *Machinery's Handbook*.

IMPORTANT: The speeds and feeds listed above are a general starting point for all applications. Refer to the Coolant Recommendation charts for coolant requirements to run at the recommended speeds and feeds. Factory technical assistance is also available through our Application Engineering Team. Due to potential chip formation issues, contact our Application Engineering Team for assistance machining materials marked with a ❖.

Coolant Recommendations | Imperial (inch)

Carbide

ISO	Material	Pressure / Flow Rate	Tube No. 4 - 5	Tube No. 6 - 8	Tube No. 10	Tube No. 12 - 16	Tube No. 20 - 24
			T-A Series Y - Z	T-A Series 0	T-A Series 1	T-A Series 2	T-A Series 3
P	Free Machining Steel 1118, 1215, 12L14, etc.	PSI	195	140	160	140	155
		GPM	2.6	3.3	5.5	9	18
	Low Carbon Steel 1010, 1020, 1025, 1522, 1144, etc.	PSI	180	105	105	110	115
		GPM	2.5	2.9	4.4	8	15
	Medium Carbon Steel 1030, 1040, 1050, 1527, 1140, 1151, etc.	PSI	175	100	90	100	75
		GPM	2.5	2.8	4.1	7	13
	Alloy Steel 4140, 5140, 8640, etc.	PSI	165	85	100	75	70
		GPM	2.4	2.6	4.3	6	12
	High Strength Alloy 4340, 4330V, 300M, etc.	PSI	160	65	55	40	35
		GPM	2.4	2.3	3.2	5	8
	Structural Steel A36, A285, A516, etc.	PSI	175	115	105	75	70
		GPM	2.5	3	4.4	6	12
	Tool Steel H-13, H-21, A-4, O-2, S-3, etc.	PSI	155	60	55	40	35
		GPM	2.4	2.2	3.2	5	8
S	High Temp Alloy Hastelloy B, Inconel 600, etc.	PSI	150 - 155	60 - 65	50 - 55	30 - 35	25 - 30
		GPM	2.3 - 2.4	2.2 - 2.3	3.1 - 3.2	4 - 5	7 - 8
M	Stainless Steel 400 Series 416, 420, 303, etc.	PSI	329	239	260	250	190
		GPM	3	4	7	12	20
K	Nodular, Grey, Ductile Cast Iron	PSI	225	104	90	90	80
		GPM	3	3	4	7	13
N	Aluminum	PSI	350	319	315	284	200
		GPM	4	5	8	12	20

IMPORTANT: The coolant pressure and flow rate recommendations above represent a good approximation to obtain optimum tool life and chip evacuation at Allied's recommended speeds and feeds. If lower coolant capabilities exist in a drilling application, the AccuPort 432 Port Contour Cutter will still function at reduced penetration rates. Contact our Application Engineering Department for a more specific recommendation of coolant requirements and/or speeds and feeds.

A
DRILLING
B
BORING
C
REAMING
D
BURNISHING
E
THREADING
X
SPECIALS

Recommended Drilling Data | Metric (mm)

HSS

ISO	Material	Hardness (BHN)	Grade	Speed (M/min)				Feed Rate (mm/rev) by Tube Size and T-A® Insert Series					
				TiN	TiAlN	TiCN	AM200®	Tube No. 4 - 5	Tube No. 6 - 8	Tube No. 10	Tube No. 12 - 16	Tube No. 20 - 24	Tube No. 32
								T-A Series Y - Z	T-A Series 0	T-A Series 1	T-A Series 2	T-A Series 3	T-A Series 4
P	Free Machining Steel 1118, 1215, 12L14, etc.	100 - 150	HSS	61	85	79	92	0.18	0.25	0.33	0.41	0.51	0.58
		150 - 200	HSS	55	79	72	87	0.18	0.25	0.33	0.41	0.51	0.58
		200 - 250	HSS	49	73	64	81	0.15	0.25	0.33	0.41	0.51	0.58
	Low Carbon Steel 1010, 1020, 1025, 1522, 1144, etc.	85 - 125	HSS	52	76	67	84	0.15 ❖	0.23	0.30	0.38	0.48	0.58
		125 - 175	HSS	49	73	64	81	0.15 ❖	0.23	0.30	0.38	0.48	0.58
		175 - 225	HSS	46	69	59	76	0.13 ❖	0.20	0.25	0.36	0.46	0.53
		225 - 275	HSS	43	64	55	70	0.13 ❖	0.20	0.25	0.36	0.46	0.53
	Medium Carbon Steel 1030, 1040, 1050, 1527, 1140, 1151, etc.	125 - 175	HSS	49	73	64	79	0.15	0.23	0.30	0.38	0.48	0.58
		175 - 225	HSS	46	69	59	75	0.13	0.20	0.25	0.36	0.46	0.53
		225 - 275	HSS	43	64	55	70	0.13	0.20	0.25	0.36	0.46	0.53
		275 - 325	SC	40	59	52	66	0.10	0.18	0.23	0.30	0.41	0.48
	Alloy Steel 4140, 5140, 8640, etc.	125 - 175	HSS	46	64	59	69	0.15	0.20	0.25	0.36	0.43	0.48
		175 - 225	HSS	43	59	55	66	0.13	0.20	0.25	0.36	0.43	0.48
		225 - 275	HSS	40	55	52	60	0.13	0.18	0.25	0.36	0.43	0.48
		275 - 325	SC	37	52	47	56	0.10	0.15	0.23	0.30	0.38	0.43
		325 - 375	SC	34	47	44	55	0.08	0.15	0.23	0.30	0.38	0.43
	High Strength Alloy 4340, 4330V, 300M, etc.	225 - 300	SC	24	34	30	37	0.13 ❖	0.18	0.23	0.25	0.36	0.43
		300 - 350	SC	18	26	24	27	0.10 ❖	0.18	0.23	0.25	0.36	0.43
		350 - 400	SC	15	21	20	23	0.08 ❖	0.15	0.20	0.23	0.30	0.38
	Structural Steel A36, A285, A516, etc.	100 - 150	HSS	43	61	55	67	0.15 ❖	0.25	0.30	0.36	0.46	0.53
150 - 250		HSS	37	52	47	56	0.13 ❖	0.23	0.25	0.30	0.41	0.48	
250 - 350		SC	30	43	40	47	0.10 ❖	0.20	0.23	0.25	0.36	0.43	
Tool Steel H-13, H-21, A-4, O-2, S-3, etc.	150 - 200	SC	24	34	32	37	0.10	0.15	0.20	0.25	0.30	0.38	
	200 - 250	SC	18	27	26	31	0.10	0.15	0.20	0.25	0.30	0.38	
S	High Temp Alloy Hastelloy B, Inconel 600, etc.	140 - 220	SC	30	40	35	45	0.08 ❖	0.18	0.20	0.25	0.30	0.38
		220 - 310	SC	25	35	30	40	0.08 ❖	0.15	0.18	0.20	0.25	0.30
M	Stainless Steel 400 Series 416, 420, 303, etc.	185 - 275	SC	23	32	29	33	0.15 ❖	0.20	0.23	0.28	0.36	0.41
		275 - 350	SC	18	27	24	29	0.13 ❖	0.18	0.20	0.25	0.30	0.36
K	Nodular, Grey, Ductile Cast Iron	120 - 150	HSS	52	76	67	82	0.18	0.30	0.41	0.51	0.61	0.69
		150 - 200	HSS	46	69	59	75	0.15	0.28	0.36	0.46	0.56	0.64
		200 - 220	HSS	40	59	52	66	0.15	0.23	0.30	0.41	0.46	0.53
		220 - 260	SC	34	50	44	55	0.13	0.18	0.23	0.30	0.36	0.43
		260 - 320	SC	27	41	37	44	0.10	0.15	0.18	0.23	0.30	0.36
N	Aluminum	30	HSS	183	259	229	-	0.20	0.33	0.41	0.51	0.56	0.64
		180	HSS	91	137	122	-	0.20	0.33	0.41	0.46	0.56	0.64

Formulas

<p>1. $RPM = (318.47 \cdot M/min) / DIA$</p> <p>where:</p> <p>RPM = revolutions per minute (rev/min)</p> <p>M/min = speed (M/min)</p> <p>DIA = finish diameter of drill (mm)</p>	<p>2. $M/min = RPM \cdot 0.003 \cdot DIA$</p> <p>where:</p> <p>M/min = speed (M/min)</p> <p>RPM = revolutions per minute (rev/min)</p> <p>DIA = diameter of drill (mm)</p>	<p>3. $IPM = RPM \cdot mm/rev$</p> <p>where:</p> <p>IPM = feed rate</p> <p>RPM = revolutions per minute (rev/min)</p> <p>mm/rev = feed rate (mm/rev)</p>
---	---	---

The table and equations on this page are found in the *Machinery's Handbook*. Permission to simplify and print the equations is granted by the Editor of the *Machinery's Handbook*.

IMPORTANT: The speeds and feeds listed above are a general starting point for all applications. Refer to the Coolant Recommendation charts for coolant requirements to run at the recommended speeds and feeds. Factory technical assistance is also available through our Application Engineering Team. Due to potential chip formation issues, contact our Application Engineering Team for assistance machining materials marked with a ❖.

Coolant Recommendations | Metric (mm)

HSS

ISO	Material	Pressure / Flow Rate	Tube No. 4 - 5	Tube No. 6 - 8	Tube No. 10	Tube No. 12 - 16	Tube No. 20 - 24	Tube No. 32
			T-A Series Y - Z	T-A Series 0	T-A Series 1	T-A Series 2	T-A Series 3	T-A Series 4
P	Free Machining Steel 1118, 1215, 12L14, etc.	BAR	12 - 13	7 - 8	7 - 10	6 - 8	6 - 7	3 - 4
		LPM	9.5 - 9.8	10.6 - 11.4	16.7 - 19.7	26.5 - 30.3	45.4 - 53.0	114 - 125
	Low Carbon Steel 1010, 1020, 1025, 1522, 1144, etc.	BAR	11 - 12	5 - 6	5 - 7	4 - 6	4 - 5	2 - 3
		LPM	9.1 - 9.5	9.1 - 9.8	14.0 - 15.9	22.7 - 26.5	41.6 - 45.4	98 - 114
	Medium Carbon Steel 1030, 1040, 1050, 1527, 1140, 1151, etc.	BAR	11	5 - 6	5 - 6	4 - 5	3 - 5	2 - 3
		LPM	8.7 - 9.1	8.7 - 9.8	13.6 - 15.5	18.9 - 22.7	37.9 - 45.4	98 - 114
	Alloy Steel 4140, 5140, 8640, etc.	BAR	11	5 - 6	5	3 - 5	3 - 4	2
		LPM	8.7 - 9.1	13.2 - 14.8	8.3 - 9.1	18.9 - 22.7	34.1 - 37.9	87 - 98
	High Strength Alloy 4340, 4330V, 300M, etc.	BAR	10 - 11	4 - 5	3 - 4	2	2	2
		LPM	8.7 - 9.1	7.9 - 8.3	11.0 - 11.7	15.1 - 18.9	26.5 - 30.3	79 - 87
	Structural Steel A36, A285, A516, etc.	BAR	11	5 - 6	5 - 6	3 - 4	3	2
		LPM	8.7 - 9.1	9.1 - 9.8	13.2 - 14.8	18.9 - 22.7	34.1 - 37.9	87 - 98
	Tool Steel H-13, H-21, A-4, O-2, S-3, etc.	BAR	4	10 - 11	3	2	2	1 - 2
		LPM	7.9 - 8.3	8.7 - 9.1	11.0 - 11.7	15.1 - 18.9	26.5 - 30.3	79 - 87
S	High Temp Alloy Hastelloy B, Inconel 600, etc.	BAR	10 - 11	4 - 5	3 - 4	2	2	2
		LPM	8.7 - 9.1	8.3 - 8.7	11.7 - 12.1	15.1 - 18.9	26.5 - 30.3	87 - 98
M	Stainless Steel 400 Series 416, 420, 303, etc.	BAR	11.4 - 11.7	4.8 - 5.8	4.5 - 5.2	2.7 - 3.8	2.7 - 3.4	1.7 - 2
		LPM	9.1 - 9.5	8.7 - 9.8	13.2 - 14	18.9 - 22.7	34.1 - 37.9	87 - 98
K	Nodular, Grey, Ductile Cast Iron	BAR	10.7 - 11.0	4.1 - 4.5	3.4 - 4.1	2 - 2.7	2 - 2.4	1.7 - 2
		LPM	8.7 - 9.1	8.3 - 8.7	11.7 - 12.5	15.1 - 18.9	30.3 - 34.1	87 - 98
N	Aluminum	BAR	13.1 - 14.5	9.6 - 12.4	10.3 - 15.8	7.9 - 11	6.2 - 8.6	2.7 - 3.4
		LPM	9.8 - 10.2	12.5 - 14	20.1 - 23.1	30.3 - 34.1	53 - 60.6	114 - 125

IMPORTANT: The coolant pressure and flow rate recommendations above represent a good approximation to obtain optimum tool life and chip evacuation at Allied's recommended speeds and feeds. If lower coolant capabilities exist in a drilling application, the AccuPort 432 Port Contour Cutter will still function at reduced penetration rates. Contact our Application Engineering Department for a more specific recommendation of coolant requirements and/or speeds and feeds.

A
DRILLING
B
BORING
C
REAMING
D
BURNISHING
E
THREADING
X
SPECIALS

Recommended Drilling Data | Metric (mm)

Carbide

ISO	Material	Hardness (BHN)	Grade	Speed (M/min)			Feed Rate (mm/rev) by Tube Size and T-A® Insert Series				
				TiN	TiAlN	AM200®	Tube No. 4 - 5	Tube No. 6 - 8	Tube No. 10	Tube No. 12 - 16	Tube No. 20 - 24
							T-A Series Y - Z	T-A Series 0	T-A Series 1	T-A Series 2	T-A Series 3
P	Free Machining Steel 1118, 1215, 12L14, etc.	100 - 150	K35, P40	98	128	146	0.020	0.30	0.38	0.46	0.53
		150 - 200	K35, P40	85	110	126	0.18	0.28	0.36	0.41	0.48
		200 - 250	K35, P40	79	104	119	0.15	0.25	0.33	0.38	0.43
	Low Carbon Steel 1010, 1020, 1025, 1522, 1144, etc.	85 - 125	K35, P40	91	119	137	0.20 ❖	0.25	0.33	0.43	0.48
		125 - 175	K35, P40	79	104	119	0.18 ❖	0.25	0.33	0.41	0.46
		175 - 225	K35, P40	73	94	108	0.15 ❖	0.23	0.30	0.38	0.43
		225 - 275	K35, P40	64	82	94	0.13 ❖	0.23	0.30	0.38	0.43
	Medium Carbon Steel 1030, 1040, 1050, 1527, 1140, 1151, etc.	125 - 175	K35, P40	79	104	119	0.18	0.25	0.33	0.41	0.46
		175 - 225	K35, P40	73	94	108	0.15	0.23	0.30	0.38	0.43
		225 - 275	K35, P40	64	82	94	0.15	0.23	0.30	0.38	0.43
		275 - 325	K35, P40	55	70	81	0.13	0.20	0.28	0.36	0.41
	Alloy Steel 4140, 5140, 8640, etc.	125 - 175	K35, P40	76	99	114	0.18	0.25	0.33	0.41	0.46
		175 - 225	K35, P40	70	91	105	0.15	0.23	0.30	0.38	0.43
		225 - 275	K35, P40	64	82	94	0.15	0.23	0.30	0.38	0.43
		275 - 325	K35, P40	61	76	87	0.13	0.20	0.28	0.36	0.41
		325 - 375	K35, P40	52	67	78	0.10	0.18	0.25	0.33	0.38
	High Strength Alloy 4340, 4330V, 300M, etc.	225 - 300	K35, P40	49	61	73	0.15 ❖	0.23	0.25	0.30	0.38
		300 - 350	K35, P40	43	55	62	0.13 ❖	0.20	0.23	0.28	0.36
350 - 400		K35, P40	37	49	56	0.10 ❖	0.18	0.20	0.25	0.30	
Structural Steel A36, A285, A516, etc.	100 - 150	K35, P40	73	94	108	0.20 ❖	0.28	0.36	0.41	0.46	
	150 - 250	K35, P40	61	76	87	0.15 ❖	0.25	0.30	0.36	0.41	
	250 - 350	K35, P40	55	70	81	0.13 ❖	0.23	0.28	0.30	0.36	
Tool Steel H-13, H-21, A-4, O-2, S-3, etc.	150 - 200	K35, P40	49	67	78	0.10 ❖	0.18	0.23	0.28	0.33	
	200 - 250	K35, P40	37	52	59	0.10 ❖	0.18	0.23	0.28	0.33	
S	High Temp Alloy Hastelloy B, Inconel 600, etc.	140 - 220	K20	24	32	36	0.10 ❖	0.18	0.23	0.28	0.33
		220 - 310	K20	18	26	29	0.10 ❖	0.15	0.20	0.25	0.30
M	Stainless Steel 400 Series 416, 420, 303, etc.	185 - 275	K20	49	64	73	0.18 ❖	0.23	0.30	0.36	0.41
		275 - 350	K20	37	49	46	0.15 ❖	0.20	0.28	0.30	0.36
K	Nodular, Grey, Ductile Cast Iron	120 - 150	K20, K10	98	140	152	0.20	0.30	0.38	0.48	0.58
		150 - 200	K20, K10	82	122	146	0.18	0.28	0.33	0.43	0.53
		200 - 220	K20, K10	73	110	131	0.15	0.23	0.30	0.38	0.46
		220 - 260	K20, K10	64	94	113	0.13	0.20	0.28	0.33	0.38
		260 - 320	K20, K10	55	82	102	0.13	0.18	0.25	0.28	0.33
N	Aluminum	30	K20	366	457	-	0.25	0.38	0.46	0.51	0.56
		180	K20	244	305	-	0.23	0.33	0.41	0.46	0.51

Formulas

<p>1. $RPM = (318.47 \cdot M/min) / DIA$</p> <p>where:</p> <p>RPM = revolutions per minute (rev/min)</p> <p>M/min = speed (M/min)</p> <p>DIA = finish diameter of drill (mm)</p>	<p>2. $M/min = RPM \cdot 0.003 \cdot DIA$</p> <p>where:</p> <p>M/min = speed (M/min)</p> <p>RPM = revolutions per minute (rev/min)</p> <p>DIA = diameter of drill (mm)</p>	<p>3. $IPM = RPM \cdot mm/rev$</p> <p>where:</p> <p>IPM = feed rate</p> <p>RPM = revolutions per minute (rev/min)</p> <p>mm/rev = feed rate (mm/rev)</p>
---	---	---

The table and equations on this page are found in the *Machinery's Handbook*. Permission to simplify and print the equations is granted by the Editor of the *Machinery's Handbook*.

IMPORTANT: The speeds and feeds listed above are a general starting point for all applications. Refer to the Coolant Recommendation charts for coolant requirements to run at the recommended speeds and feeds. Factory technical assistance is also available through our Application Engineering Team. Due to potential chip formation issues, contact our Application Engineering Team for assistance machining materials marked with a ❖.

Coolant Recommendations | Metric (mm)

Carbide

ISO	Material	Pressure / Flow Rate	Tube No.	Tube No.	Tube No.	Tube No.	Tube No.
			4 - 5	6 - 8	10	12 - 16	20 - 24
			T-A Series Y - Z	T-A Series 0	T-A Series 1	T-A Series 2	T-A Series 3
P	Free Machining Steel 1118, 1215, 12L14, etc.	BAR	20	16	17	15	12
		LPM	12.2	16.3	25.3	41.5	71.9
	Low Carbon Steel 1010, 1020, 1025, 1522, 1144, etc.	BAR	11.4	13.3	20.6	36.5	62
		LPM	17	10	10	10	8
	Medium Carbon Steel 1030, 1040, 1050, 1527, 1140, 1151, etc.	BAR	17	9	10	8	7
		LPM	11.1	12.3	19.3	30	55.8
	Alloy Steel 4140, 5140, 8640, etc.	BAR	10.4	9.1	12.6	18.8	33.6
		LPM	16	9	8	7	5
	High Strength Alloy 4340, 4330V, 300M, etc.	BAR	15	5	5	3	3
		LPM	10.4	9.1	13.6	19.7	36.5
	Structural Steel A36, A285, A516, etc.	BAR	16	9	8	7	5
		LPM	10.8	12	17.5	27.8	47.1
	Tool Steel H-13, H-21, A-4, O-2, S-3, etc.	BAR	15	5	5	3	3
		LPM	10.4	9.1	13.6	19.7	36.5
S	High Temp Alloy Hastelloy B, Inconel 600, etc.	BAR	17	11.4	12.4	11	9
		LPM	11.1	13.5	21.9	35.4	62
M	Stainless Steel 400 Series 416, 420, 303, etc.	BAR	22.7	16.5	17.9	17.2	13.1
		LPM	13	16.3	26.3	44.2	75
K	Nodular, Grey, Ductile Cast Iron	BAR	15.5	7.2	6.2	6.2	5.5
		LPM	10.7	10.8	15.4	26.5	48.7
N	Aluminum	BAR	24.1	22	21.7	19.6	13.8
		LPM	13.4	18.8	29	47.2	77

IMPORTANT: The coolant pressure and flow rate recommendations above represent a good approximation to obtain optimum tool life and chip evacuation at Allied's recommended speeds and feeds. If lower coolant capabilities exist in a drilling application, the AccuPort 432 Port Contour Cutter will still function at reduced penetration rates. Contact our Application Engineering Department for a more specific recommendation of coolant requirements and/or speeds and feeds.

A
DRILLING
B
BORING
C
REAMING
D
BURNISHING
E
THREADING
X
SPECIALS

BT-A Drill

BTA (STS) Deep Hole Machining System

▶ **Diameter Range:** 0.5100" - 1.8820" (12.95mm - 47.80mm)



Material Ejection with Efficiency

The BT-A Drill (using the single tube system, or STS) conquers deep hole applications in ways other drills simply cannot. The internal ejection system flushes chips and debris from the hole with no interference to the cutting process.

By utilizing the countless advantages of the T-A® drill insert, the BT-A design significantly increases penetration rates over brazed heads and traditional gun drills. A specific BT geometry has also been developed to increase productivity in these types of drilling applications.

Excellent hole size and finish	Optimizes chip evacuation	Up to 2x the penetration rate of traditional BTA heads
--------------------------------	---------------------------	---

Applicable Industries



Your safety and the safety of others is very important. This catalog contains important safety messages. Always read and follow all safety precautions.



This triangle is a safety hazard symbol. It alerts you to potential safety hazards that can cause tool failure and serious injury.

When you see this symbol in the catalog, look for a related safety message that may be near this triangle or referred to in the nearby text.

There are safety signal words also used in the catalog. Safety messages follow these words.

WARNING

WARNING (shown above) means that failure to follow the precautions in this message could result in tool failure and serious injury.

NOTICE means that failure to follow the precautions in this message could result in damage to the tool or machine but not result in personal injury.

NOTE and **IMPORTANT** are also used. These are important that you read and follow but are not safety-related.

Visit www.alliedmachine.com for the most up-to-date information and procedures.

Reference Icons

The following icons will appear throughout the catalog to help you navigate between products.

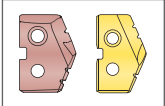

T-A® Inserts

Refers to the range of inserts that connect with the corresponding holders

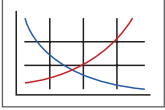

Recommended Cutting Data

Speed and feed recommendations for optimum and safe drilling

Introduction Information

System Overview 2
 Product Nomenclature 3

T-A Drill Series

0 Series 4
 1 Series 5
 2 Series 6
 3 Series 7

Series	Diameter Range	
	Imperial (inch)	Metric (mm)
0	0.5100 - 0.6959	12.95 - 17.68
1	0.6960 - 0.9600	17.69 - 24.38
2	0.9601 - 1.3800	24.39 - 35.05
3	1.3801 - 1.8820	35.06 - 47.80

System Overview

BTA Machining

BTA machining is the reverse of typical gun drilling systems. The BT-A Drill is a drill head consisting of a holder body and a replaceable tip T-A® insert. The drill head threads into an STS (single tube system) cylindrical tube with a diameter smaller than the drill head. The difference in diameter forms an annular area between the hole and the tube OD. This allows high volume coolant to be directed to the cutting edge.

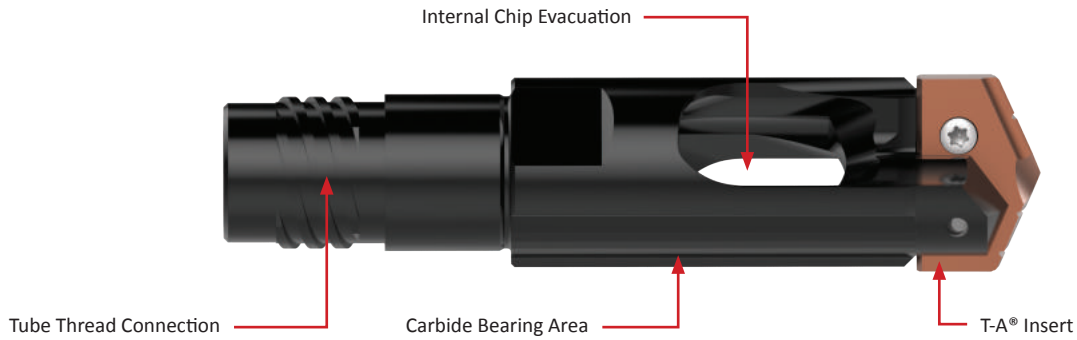

- ✓ **Improve hole straightness**
with the laser clad bearing area
- ✓ **Eliminate the need for re-sharpening**
with replaceable cutting edges
- ✓ **Reduce your inventory**
with the replaceable T-A® feature
- ✓ **Compatibility**
heads are compatible with standard BTA-STS systems
- ✓ **Balanced cutting forces**
- ✓ **Patent-pending design**

Original T-A Insert: BT-A Geometry (-BT)

- Low thrust web geometry reduces Z-axis requirements
- Tiny chip (-TC) lip geometry improves chip formation
- Polished cutting surface eliminates material build-up

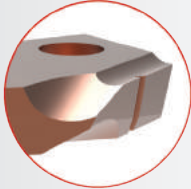

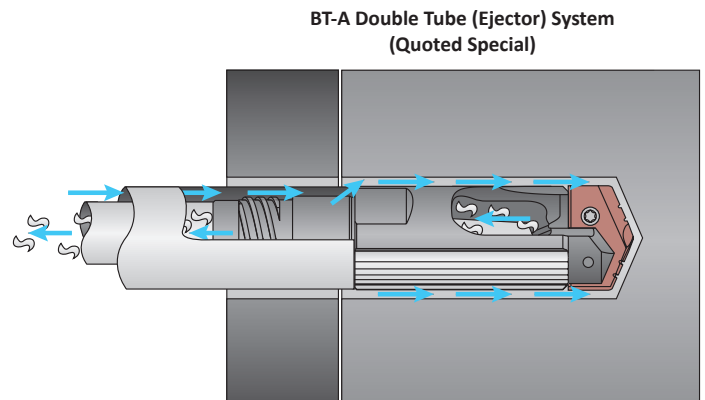
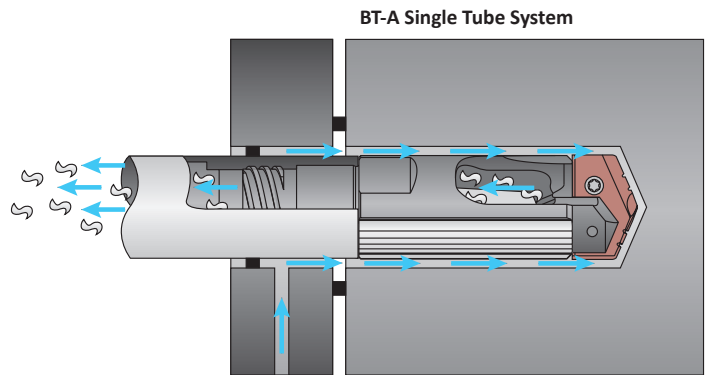

2x INCREASE in penetration rates over traditional BTA heads

Product Nomenclature

BT-A Drill Holders

BTA2	-	804	-	1.1299
1		2		3

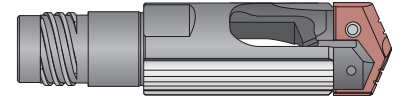

1. BT-A Drill T-A Insert Series
BTA0 = 0 series T-A insert
BTA1 = 1 series T-A insert
BTA2 = 2 series T-A insert
BTA3 = 3 series T-A insert

2. Tube Size		
794	800	806
795	801	807
796	802	808
797	803	809
798	804	810
799	805	811

3. Diameter
0.7344 = Inch
25.00 = Metric

Reference Key

Symbol	Attribute
D_1	Drill insert range
L_1	Overall length
L_3	Holder reference length
L_7	Shank length

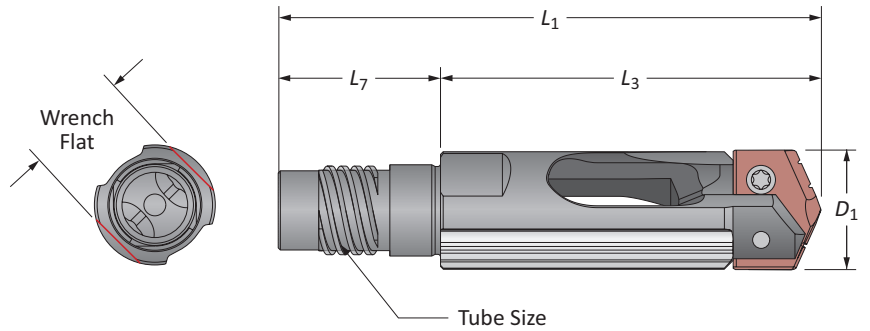

BT-A Drill Tubes

BTAT	-	804	-	63
1		2		3

1. BT-A Drill T-A Insert Series
BTAT = BT-A Tube

2. Tube Size		
794	800	806
795	801	807
796	802	808
797	803	809
798	804	810
799	805	811

3. Length
63 = Standard
102 = Long

Reference Key

Symbol	Attribute
D_1	Body diameter
ID_1	Internal diameter
OD_1	Outer diameter
L_1	Overall length

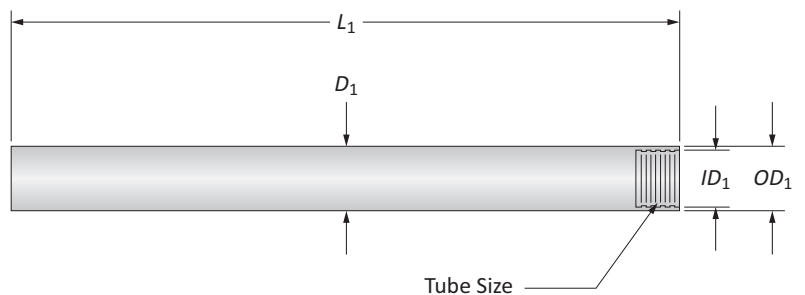



BT-A Drill Holders

0 Series | Diameter Range: 0.5100" - 0.6959" (12.95mm - 17.68mm)

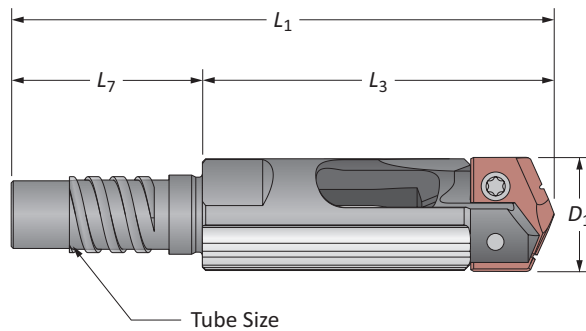
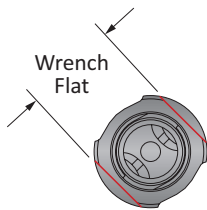

Tube Size	D_1	Holder				Part No.	 T-A® Insert	Wrench Flat (mm)
		L_3	L_1	L_7				
i	794	0.5100 - 0.5359	1-45/64	2-39/64	29/32	BTA0-794-X.XXXX	1C10H-XXXX-BT	11
	795	0.5360 - 0.5759	1-3/4	2-21/32	29/32	BTA0-795-X.XXXX	1C10H-XXXX-BT	12
	796	0.5760 - 0.6149	1-13/16	2-3/4	61/64	BTA0-796-X.XXXX	1C10H-XXXX-BT	13
	797	0.6150 - 0.6579	1-13/16	2-3/4	61/64	BTA0-797-X.XXXX	1C10H-XXXX-BT	14
	798	0.6580 - 0.6959	1-25/32	2-47/64	61/64	BTA0-798-X.XXXX	1C10H-XXXX-BT	15
m	794	12.95 - 13.61	43.4	66.4	23	BTA0-794-XX.XX	1C10H-XXXX-BT	11
	795	13.62 - 14.63	44.6	67.6	23	BTA0-795-XX.XX	1C10H-XXXX-BT	12
	796	14.64 - 15.62	45.9	69.9	24	BTA0-796-XX.XX	1C10H-XXXX-BT	13
	797	15.63 - 16.71	45.9	69.9	24	BTA0-797-XX.XX	1C10H-XXXX-BT	14
	798	16.72 - 17.68	45.3	69.3	24	BTA0-798-XX.XX	1C10H-XXXX-BT	15

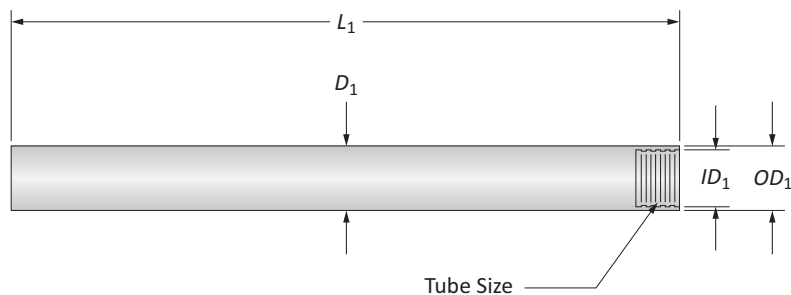

Tube Size	D_1 Range	Tube			L_1	Part No.
		OD_1	ID_1			
i	794	0.510 - 0.535	0.433	0.276	63	BTAT794-63
	794	0.510 - 0.535	0.433	0.276	102	BTAT794-102
	795	0.536 - 0.575	0.472	0.315	63	BTAT795-63
	795	0.536 - 0.575	0.472	0.315	102	BTAT795-102
	796	0.576 - 0.614	0.512	0.335	63	BTAT796-63
	796	0.576 - 0.614	0.512	0.335	102	BTAT796-102
	797	0.615 - 0.657	0.551	0.354	63	BTAT797-63
	797	0.615 - 0.657	0.551	0.354	102	BTAT797-102
	798	0.658 - 0.696	0.591	0.394	63	BTAT798-63
	798	0.658 - 0.696	0.591	0.394	102	BTAT798-102

Section A30

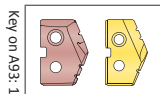

i = Imperial (in)
m = Metric (mm)

BT-A Drill Holders

1 Series | Diameter Range: 0.6960" - 0.9600" (17.69mm - 24.38mm)

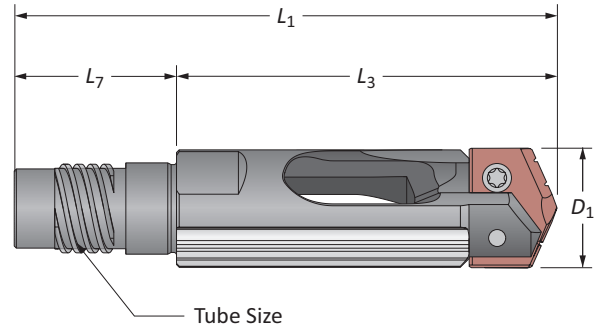
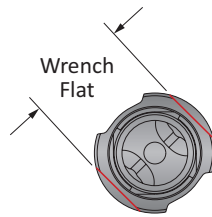

Tube Size	D_1	Holder			Part No.	T-A® Insert	Wrench Flat (mm)	
		L_3	L_1	L_7				
i	799	0.6960 - 0.7449	2-15/64	3-9/32	63/64	BTA1-799-X.XXXX	1C11H-XXXX-BT	16
	800	0.7450 - 0.7879	2-5/16	3-27/64	1-7/64	BTA1-800-X.XXXX	1C11H-XXXX-BT	17
	801	0.7880 - 0.8589	2-11/32	3-35/64	1-13/64	BTA1-801-X.XXXX	1C11H-XXXX-BT	18
	802	0.8590 - 0.9489	2-25/64	3-11/16	1-19/64	BTA1-802-X.XXXX	1C11H-XXXX-BT	19
	803	0.9490 - 0.9600	2-33/64	3-13/16	1-19/64	BTA1-803-X.XXXX	1C11H-XXXX-BT	21
m	799	17.69 - 18.92	58.2	83.2	25	BTA1-799-XX.XX	1C11H-XXXX-BT	16
	800	18.93 - 20.01	58.8	86.8	28	BTA1-800-XX.XX	1C11H-XXXX-BT	17
	801	20.02 - 21.81	59.4	89.9	30.5	BTA1-801-XX.XX	1C11H-XXXX-BT	18
	802	21.82 - 24.10	60.7	93.7	33	BTA1-802-XX.XX	1C11H-XXXX-BT	19
	803	24.11 - 24.38	63.9	96.9	33	BTA1-803-XX.XX	1C11H-XXXX-BT	21

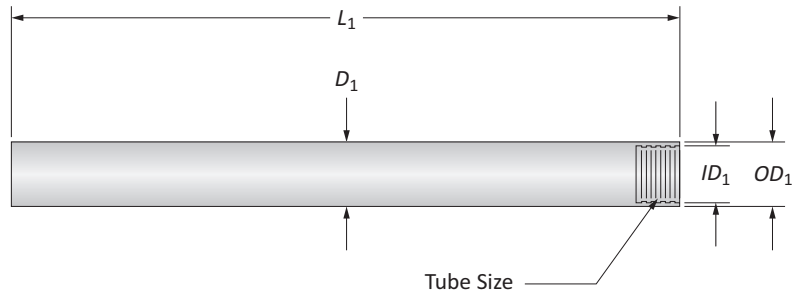

Tube Size	D_1 Range	Tube			Part No.	
		OD_1	ID_1	L_1		
i	799	17.69 - 18.90	16.0	10.5	1600	BTAT799-63
	799	17.69 - 18.90	16.0	10.5	2591	BTAT799-102
	800	18.91 - 20.00	17.0	11.5	1600	BTAT800-63
	800	18.91 - 20.00	17.0	11.5	2591	BTAT800-102
	801	20.01 - 21.79	18.0	12.0	1600	BTAT801-63
	801	20.01 - 21.79	18.0	12.0	2591	BTAT801-102
	802	21.80 - 24.08	20.0	13.0	1600	BTAT802-63
	802	21.80 - 24.08	20.0	13.0	2591	BTAT802-102
	803	24.09 - 26.39	22.0	14.0	1600	BTAT803-63
	803	24.09 - 26.39	22.0	14.0	2591	BTAT803-102

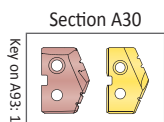

i = Imperial (in)
m = Metric (mm)

A
DRILLING
B
BORING
C
REAMING
D
BURNISHING
E
THREADING
X
SPECIALS



BT-A Drill Holders

2 Series | Diameter Range: 0.9601" - 1.3800" (24.39mm - 35.05mm)

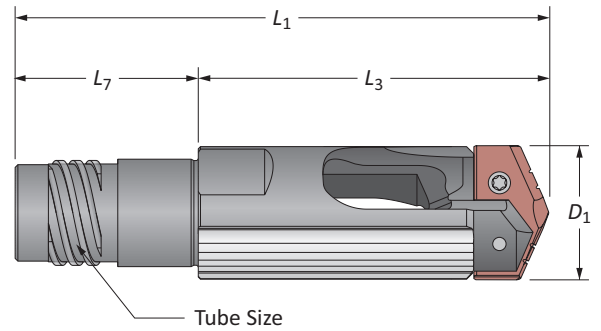
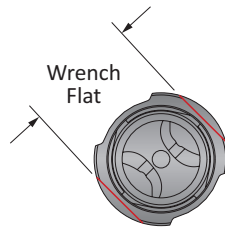
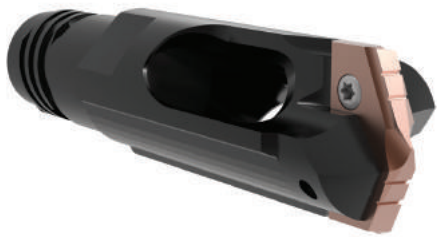

Tube Size	D_1	Holder				Part No.	 T-A® Insert	Wrench Flat (mm)
		L_3	L_1	L_7				
i	803	0.9601 - 1.0399	3-3/32	4-25/64	1-19/64	BTA2-803-X.XXXX	1C12H-XXXX-BT	21
	804	1.0400 - 1.1299	3	4-3/32	1-7/64	BTA2-804-X.XXXX	1C12H-XXXX-BT	22
	805	1.1300 - 1.2209	2-31/32	4-25/64	1-27/64	BTA2-805-X.XXXX	1C12H-XXXX-BT	25
	806	1.2210 - 1.3119	3-1/16	4-31/64	1-27/64	BTA2-806-X.XXXX	1C12H-XXXX-BT	27
	807	1.3120 - 1.3800	3-1/16	4-31/64	1-27/64	BTA2-807-X.XXXX	1C12H-XXXX-BT	30
m	803	24.39 - 26.41	78.5	111.5	33	BTA2-803-XX.XX	1C12H-XXXX-BT	21
	804	26.42 - 28.70	75.9	103.9	28	BTA2-804-XX.XX	1C12H-XXXX-BT	22
	805	28.71 - 31.01	75.4	111.4	36	BTA2-805-XX.XX	1C12H-XXXX-BT	25
	806	31.02 - 33.32	77.9	113.8	36	BTA2-806-XX.XX	1C12H-XXXX-BT	27
	807	33.33 - 35.05	77.9	113.8	36	BTA2-807-XX.XX	1C12H-XXXX-BT	30

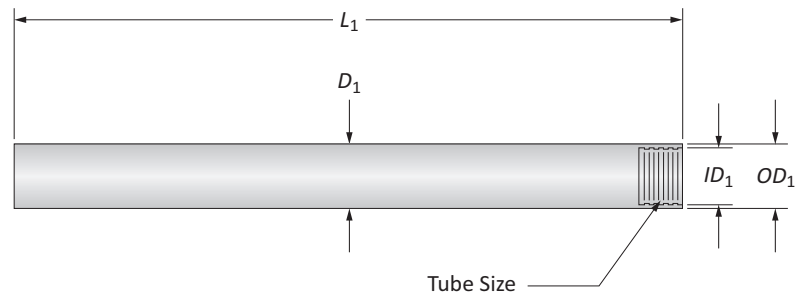

Tube Size	D_1 Range	Tube			L_1	Part No.
		OD_1	ID_1			
i	803	0.949 - 1.039	0.866	0.551	63	BTAT803-63
	803	0.949 - 1.039	0.866	0.551	102	BTAT803-102
	804	1.040 - 1.129	0.945	0.610	63	BTAT804-63
	804	1.040 - 1.129	0.945	0.610	102	BTAT804-102
	805	1.130 - 1.220	1.024	0.669	63	BTAT805-63
	805	1.130 - 1.220	1.024	0.669	102	BTAT805-102
	806	1.221 - 1.311	1.102	0.728	102	BTAT806-102
	807	1.312 - 1.425	1.181	0.787	102	BTAT807-102

Section A30

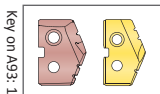

i = Imperial (in)
m = Metric (mm)

BT-A Drill Holders

3 Series | Diameter Range: 1.3801" - 1.8820" (35.06mm - 47.80mm)

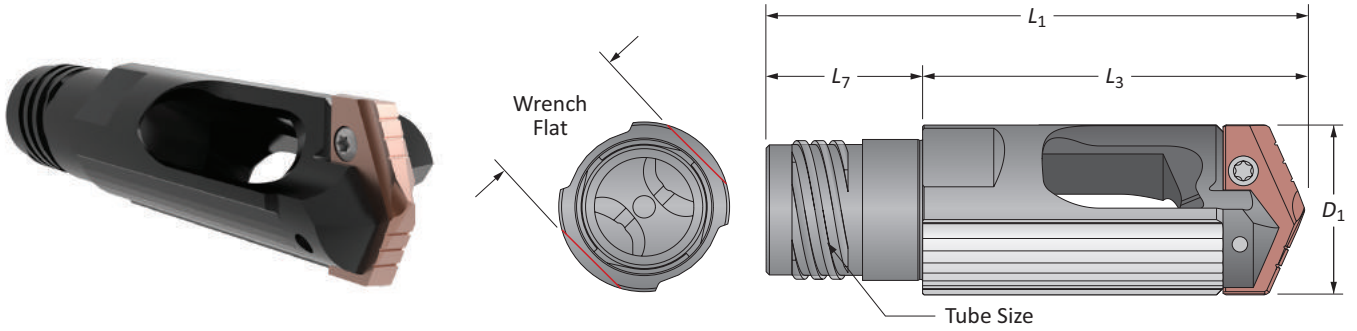

	Tube Size	D_1	Holder			Part No.	Wrench Flat (mm)
			L_3	L_1	L_7		
i	807	1.3801 - 1.4259	3-13/16	5-15/64	1-27/64	BTA3-807-X.XXXX	30
	808	1.4260 - 1.5599	3-15/16	5-11/16	1-3/4	BTA3-808-X.XXXX	32
	809	1.5600 - 1.6929	4-1/16	5-3/4	1-11/16	BTA3-809-X.XXXX	36
	810	1.6930 - 1.8509	4-1/64	5-45/64	1-11/16	BTA3-810-X.XXXX	41
	811	1.8510 - 1.8820	4-1/16	5-3/4	1-11/16	BTA3-811-X.XXXX	41
m	807	35.06 - 36.22	96.8	132.8	36	BTA3-807-XX.XX	30
	808	36.23 - 39.62	100.0	144.4	44.5	BTA3-808-XX.XX	32
	809	39.63 - 43.00	103.1	146.2	43	BTA3-809-XX.XX	36
	810	43.01 - 47.01	101.9	144.9	43	BTA3-810-XX.XX	41
	811	47.02 - 47.80	103.2	146.2	43	BTA3-811-XX.XX	41

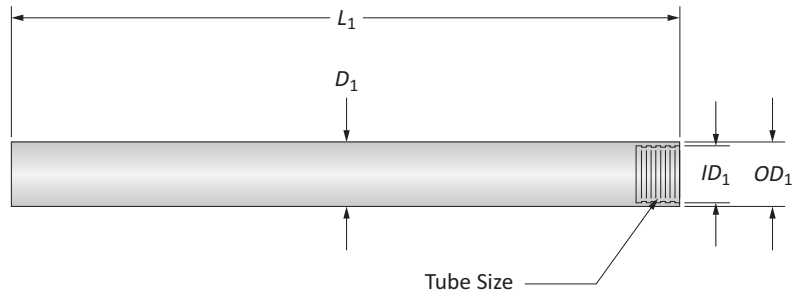

	Tube Size	D_1 Range	Tube			Part No.
			OD_1	ID_1	L_1	
i	807	1.312 - 1.425	1.181	0.787	102	BTAT807-102
	808	1.426 - 1.559	1.299	0.906	102	BTAT808-102
	809	1.560 - 1.692	1.417	0.984	102	BTAT809-102
	810	1.693 - 1.850	1.535	1.102	102	BTAT810-102
	811	1.851 - 1.882	1.693	1.220	102	BTAT811-102

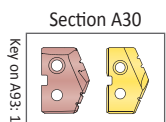

i = Imperial (in)
m = Metric (mm)

Criterion™ Modular Boring Systems

Cri-Twin® | Cri-Bore® | Large Cri-Bore® | CB Style | CBER® | Cri-Bar | Competitor Connections



CRITERION™

Boring has never been more exciting.

Criterion modular boring systems have everything you need for your rough and/or finish boring applications.

The Cri-Twin system is designed for either single or double effective cutting so you can rapidly enlarge your bore or reduce the number of passes required.

The Cri-Bore boring system is designed for finish boring applications. For extremely close tolerance boring, the Cri-Bore micro adjusting boring heads are adjustable in 0.00005" (fifty-millionths).

The CBER boring heads are designed for use in live tooling spindles, right angle heads, or any standard ER collet holder.

This catalog contains important messages that pertain to proper use of the products shown in this catalog. Always read and follow all precautions that use these words.

NOTICE means that failure to follow the precautions in this message could result in damage to the tool or machine but not result in personal injury.

NOTE and **IMPORTANT** are also used. These are important that you read and follow but are not safety-related.

Visit www.alliedmachine.com for the most up-to-date information and procedures.



Aerospace



Agriculture



Automotive



Firearms



Renewable
Energy

Criterion™ Modular Boring Systems Contents

Reference Icons

The following icons will appear throughout the catalog to help you navigate between products.

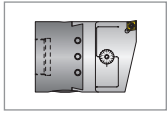

Boring Heads - Insert Holders
Standard and micro adjusting boring heads that use inserts for cutting

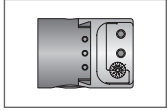

Boring Heads - Boring Bar Holders
Standard and micro adjusting boring heads that use boring bars for cutting

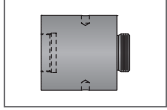

Head-to-Shank Adapters
Extensions and reducers that attach the boring head to the shank

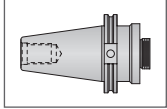

Shanks
A variety of shanks for different machines

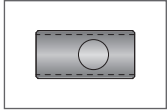

Boring Bar Adapters
For use with boring bar holder boring heads and boring bars

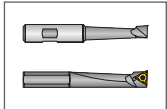

Boring Bars
For use with boring bar holder boring heads or lathe and turning center applications

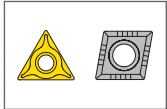

Inserts
For use with insert holder boring heads and boring bars using indexable inserts



Boring Kits
Complete boring kits including boring heads, shanks, bars, and adapters



Setup / Assembly Information
Detailed instructions and information regarding the corresponding part(s)

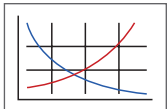

Recommended Cutting Data
Speed and feed recommendations for optimum and safe boring

Introduction Information

Modular Boring System Product Offering	2 - 3
Boring Head Bore Diameter Ranges	4 - 5
Boring Heads Nomenclature	6 - 7

Boring Heads - Insert Holders

Cri-Twin®	8 - 9
Cri-Bore®	10 - 13
Large Cri-Bore® System	14 - 15

Boring Heads - Boring Bar Holders

CB Style	16 - 17
Square and Slotted	18 - 19
Boring and Facing	20 - 21
Tiny Mite	22 - 23
Extensions, Reducers, Adapters	24 - 25

CBER® Boring System

Cri-Tip Competitor Connections

Adjustable Boring Bars

Shanks

Boring Bars

Boring bars Nomenclature	47
Carbide Style	48 - 53
Insert Style	54 - 59

Inserts

Inserts Nomenclature	60
80° Rhombic	61 - 63
60° Triangle	64 - 66
80° Trigon	67

Boring Kits and Sets

Recommended Cutting Data

Rough Boring	78 - 79
Finish Boring	80 - 81

Set-up Instructions

Cri-Twin Boring Heads	82
Standard / Micro Adjusting Boring Heads	83
Boring and Facing Boring Heads	84 - 86

Criterion Modular Boring Systems

A DRILLING
B BORING
C REAMING
D BURNISHING
E THREADING
X SPECIALS

Shanks

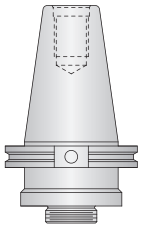

V Flange / DIN 69871

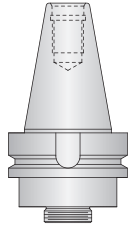

BT Flange

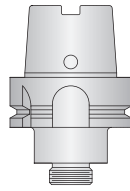

HSK

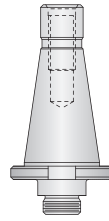

NMBT / DIN 2080

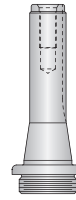

R8



Morse Taper

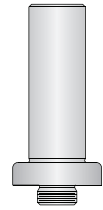

Straight

Adapters

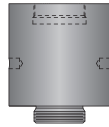

Extension



Reducer

Heads - Insert Holders



Cri-Twin®



Cri-Bore®

Heads - Bar Holders

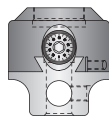

CB Style

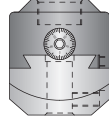

Square

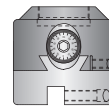

Slotted

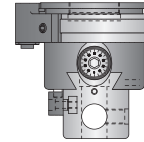

CNC
Boring & Facing

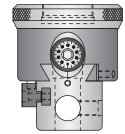

Manual
Boring & Facing

Inserts



80° Rhombic



80° Trigon



60° Triangle

TA Insert Boring Bars



Standard



Steel



Heavy Metal



Carbide Shank



Cross Hole



Boring and Facing

Carbide Boring Bars



Solid Carbide



Qualified Length



Helical Rake

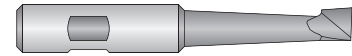

Round Shank

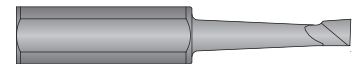

Square Shank

ER Collet Style



CBER®

Adjustable Bars



Cri-Bar

Komet® ABS® Connections

Big® Kaiser® Connections

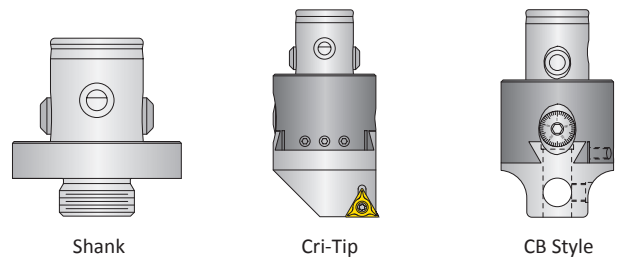
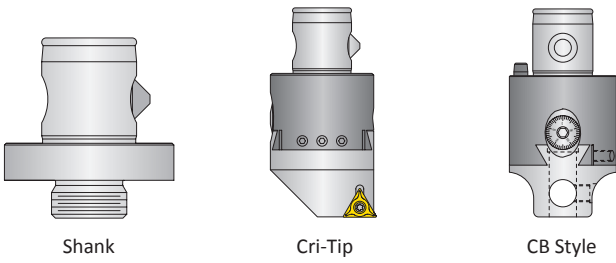

Large Cri-Bore® System

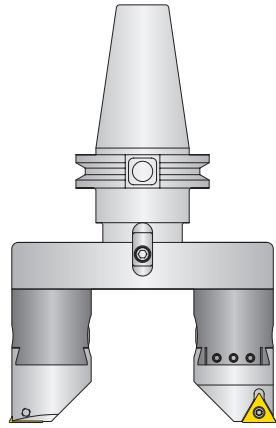

Inner Diameter Bore

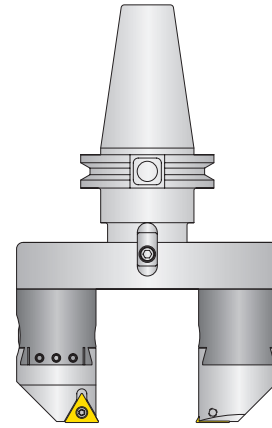

Outer Diameter Bore

Komet® and ABS® are registered trademarks of KOMET Präzisionswerkzeuge Robert Breuning GmbH, Besigheim, Germany, and are not affiliated with Allied Machine & Engineering. Big® and Kaiser® are registered trademarks of Big Daishowa Seiki Co. Ltd., Osaka, Japan, and are not affiliated with Allied Machine & Engineering.

Criterion Boring System Ranges

Cri-Twin® Modular Boring System

	D_1 Range	Item Description
i	1.100 - 1.500	CT1000
	1.400 - 1.900	CT1250
	1.600 - 2.500	CT1500
	2.100 - 3.100	CT2000
	3.100 - 5.000	CT3000
m	28 - 38	CT025M
	36 - 48	CT032M
	41 - 63	CT038M
	54 - 78	CT050M
	79 - 127	CT076M

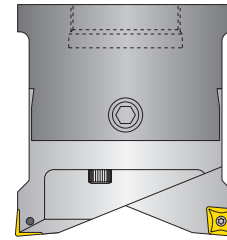

Standard Adjusting

Highlights:

- Remove **2x the amount** of material with a standard and short insert holder
- Rough and finish in the **same operation** with a standard and short insert holder
- Remove material **2x as fast** with two insert holders of the same length

Cri-Bore® Modular Boring System

	D_1 Range	Item Description
i	1.050 - 1.320	CB1000
	1.300 - 1.600	CB1250
	1.585 - 2.700	CB1500
	2.060 - 3.320	CB2000
	3.065 - 5.065	CB3000
	4.180 - 7.380	CB4000
m	27 - 33	CB025M
	33 - 41	CB032M
	41 - 68	CB038M
	53 - 84	CB050M
	78 - 128	CB076M
	104 - 187	CB101M

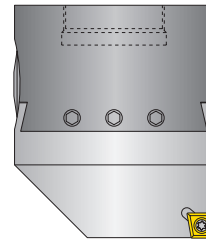

Standard Adjusting

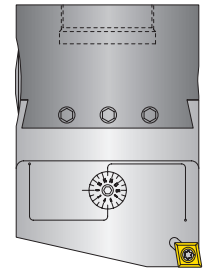

Micro Adjusting

Highlights:

- Standard adjusting is excellent for finish boring
- Micro adjusting is excellent for close tolerance boring
- Total range of micro adjustment is 0.006" (0.150mm) on diameter

Large Cri-Bore® System

	D_1 Range	Item Description
i	0.710 - 7.830	Outer diameter boring
	5.000 - 12.125	Inner diameter boring
m	19 - 198	Outer diameter boring
	127 - 307	Inner diameter boring

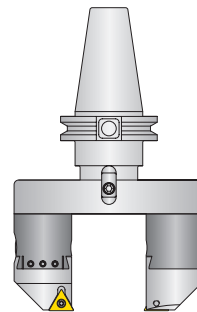

Outer Bore Diameter

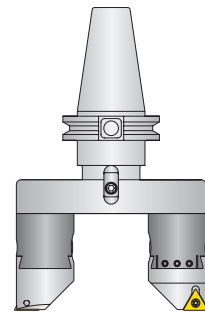

Inner Bore Diameter

i = Imperial (in)
m = Metric (mm)

Criterion Boring System Ranges

CB Style Boring Heads

	Center Hole	Outboard Hole	Cross Hole*	Item Description
i	0.050 - 1.625	–	–	CB-1500B
	0.050 - 1.625	1.000 - 2.500	–	CB-2375A
	0.050 - 1.750	1.312 - 3.000	2.875 - 6.687	CB-202
	0.050 - 3.250	2.000 - 5.125	4.937 - 11.000	CB-203
	0.050 - 3.250	3.000 - 7.000	5.625 - 13.437	CB-204
	1.750 - 5.750	5.500 - 9.500	9.093 - 21.500	CB-206
	0.050 - 1.625	1.000 - 2.500	–	CB-1500MA
	0.050 - 1.750	1.312 - 3.000	–	CB-2500MA
	0.050 - 3.250	2.375 - 5.125	–	CB-3000MA
m	3 - 40	–	–	CB-038MB
	3 - 40	25 - 62	–	CB-038MA
	3 - 40	25 - 62	–	CB-038MC
	3 - 44	35 - 76	73 - 169	CB-050M
	10 - 70	60 - 130	126 - 292	CB-076M
	10 - 113	76 - 178	143 - 341	CB-101M
	3 - 42	34 - 73	–	CB-064MBMA
	10 - 73	60 - 130	–	CB-076MDMA

*NOTICE: Cross hole maximum bore diameter is based upon cross hole bars being secured in the bar holder with at least 2 set screws

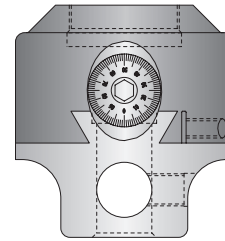

Standard Adjusting

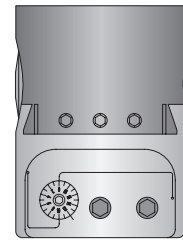

Micro Adjusting

Boring and Facing Heads

	Center Hole	Outboard Hole	Cross Hole*	Item Description
i	0.050 - 2.875	2.375 - 4.750	4.937 - 10.625	BFM-300
m	10 - 76	60 - 120	126 - 288	BFM-076

*NOTICE: Cross hole maximum bore diameter is based upon cross hole bars being secured in the bar holder with at least 2 set screws

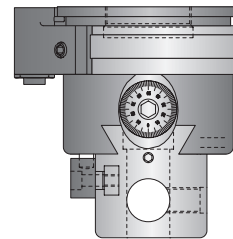

CNC Style

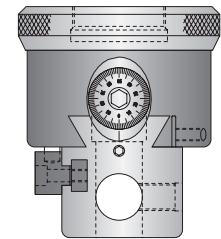

Manual Style

Highlights:

- Ideal for boring, facing, grooving, backfacing, and counterboring operations
- Available in 0.003" per revolution (or fine feed 0.0015" per revolution)
- Clutch automatically disengages the drive when preset stops are contacted
- Head feeds in both directions

Cri-Tip Competitor Connection Boring System

	Bore Diameter Range	Item Description
i	0.050 - 11.000	Big® Kaiser® connection
	0.050 - 11.000	Komet® ABS® connection
m	3 - 130	Big® Kaiser® connection
	3 - 130	Komet® ABS® connection

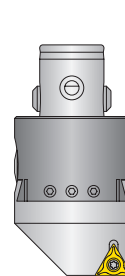

Standard Adjusting

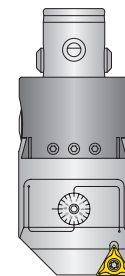

Micro Adjusting

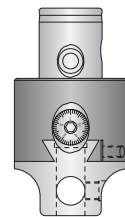

CB Style

i = Imperial (in)
m = Metric (mm)

A DRILLING
B BORING
C REAMING
D BURNISHING
E THREADING
X SPECIALS

Criterion Modular Boring Systems Nomenclature

Criterion Double Effective Boring Heads

CT	2000	–	1
1	2		3

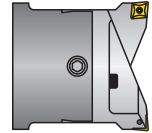

1. Boring Head Style
CT = Cri-Twin®

2. Body Style	
Imperial	Metric
1000 = 1.000"	025M = 25mm
1250 = 1.250"	032M = 32mm
1500 = 1.500"	038M = 38mm
2000 = 2.000"	050M = 50mm
3000 = 3.000"	076M = 76mm

3. Insert Holder Lead Type (Side 1 / Side 2)
0 = Zero / zero
1 = Standard / standard
2 = Standard / short

Criterion Single Effective Boring Heads

CB	2000	–	TP
1	2		3

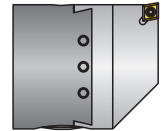

1. Boring Head Style
CB = Cri-Bore®

2. Body Style	
Imperial	Metric
1000 = 1.000"	025M = 25mm
1250 = 1.250"	032M = 32mm
1500 = 1.500"	038M = 38mm
2000 = 2.000"	050M = 50mm
3000 = 3.000"	076M = 76mm
4000 = 4.000"	101M = 101mm

3. Insert Style
TP = TP
CP = CP / CC
TPMA = TP (with micro adjustment)
CPMA = CP / CC (with micro adjustment)

Criterion Boring Bar Holder Heads

CB	–	2000	A
1		2	3

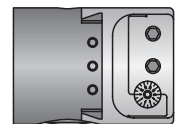

1. Boring Head Style
CB = CB Style
SQ = Square
TMT = Tiny Mite
CSL = Slotted

2. Body Size	
Imperial	Metric
002 = 1.500"	025M = 25mm
152 = 1.500"	032M = 32mm
0750 = 0.750"	038M = 38mm
1000 = 1.000"	050M = 50mm
1500 = 1.500"	076M = 76mm
2000 = 2.000"	101M = 101mm
202 = 2.000"	
3000 = 3.000"	
203 = 3.000"	
204 = 4.000"	
206 = 6.000"	

3. Tool Hole ID	
Imperial	Metric
A = 0.375"	A = 10mm
B = 0.500"	B = 12mm
C = 0.625"	C = 16mm
D = 0.750"	D = 20mm
E = 1.000"	E = 25mm
F = 1.500"	
G = 0.125"	
H = 0.250"	

Criterion Modular Boring Systems Nomenclature

Criterion Competitor Connections

CTP	2000	–	A50	TP
1	2		3	4

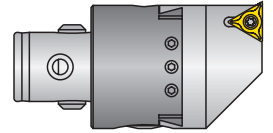

1. Boring Head Style	2. Body Size	3. Adapter Style														
CTP = Cri-Tip	<table border="0"> <tr> <td>Imperial</td> <td>Metric</td> </tr> <tr> <td>1500 = 1.500"</td> <td>038M = 38mm</td> </tr> <tr> <td>2000 = 2.000"</td> <td>050M = 50mm</td> </tr> <tr> <td>3000 = 3.000"</td> <td>076M = 76mm</td> </tr> </table>	Imperial	Metric	1500 = 1.500"	038M = 38mm	2000 = 2.000"	050M = 50mm	3000 = 3.000"	076M = 76mm	<table border="0"> <tr> <td>A40 = Komet® ABS40 connection</td> <td>KA4 = Big® Kaiser® KA4 connection</td> </tr> <tr> <td>A50 = Komet® ABS50 connection</td> <td>KA5 = Big® Kaiser® KA5 connection</td> </tr> <tr> <td>A80 = Komet® ABS80 connection</td> <td>KA7 = Big® Kaiser® KA7 connection</td> </tr> </table>	A40 = Komet® ABS40 connection	KA4 = Big® Kaiser® KA4 connection	A50 = Komet® ABS50 connection	KA5 = Big® Kaiser® KA5 connection	A80 = Komet® ABS80 connection	KA7 = Big® Kaiser® KA7 connection
Imperial	Metric															
1500 = 1.500"	038M = 38mm															
2000 = 2.000"	050M = 50mm															
3000 = 3.000"	076M = 76mm															
A40 = Komet® ABS40 connection	KA4 = Big® Kaiser® KA4 connection															
A50 = Komet® ABS50 connection	KA5 = Big® Kaiser® KA5 connection															
A80 = Komet® ABS80 connection	KA7 = Big® Kaiser® KA7 connection															

4. Boring Head Style		
Imperial		Metric
TP = TP	202B = 0.500 tool hole ID	TP = TP
CP = CP / CC	203D = 0.750 tool hole ID	CP = CP / CC
TPMA = TP (with micro adjustment)	300MA = 0.750 tool hole ID (micro adjusting)	TPMA = TP (with micro adjustment)
CPMA = CP (with micro adjustment)	DMA = 0.750 tool hole ID (micro adjusting)	CPMA = CP (with micro adjustment)
002 = 0.500 tool hole ID		B = 12mm tool hole ID
152 = 0.375 tool hole ID		D = 20mm tool hole ID
202A = 0.375 tool hole ID		MDMA = 20mm tool hole ID (micro adjusting)

Reference Key

Symbol	Attribute
D_1	Bore diameter range
D_2	Body diameter
D_3	Inner diameter
D_4	Shank diameter
L_1	Overall length
L_{10}	Square length
IC	Inscribed circle
T_1	Insert thickness

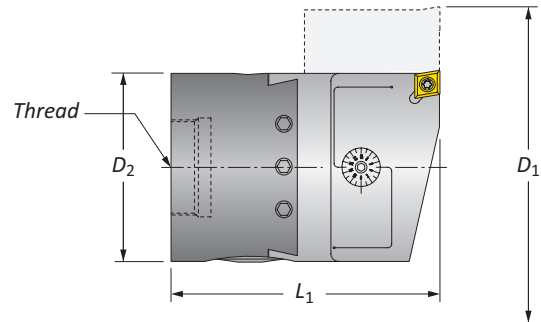

Cri-Twin® Boring Heads

Standard Adjusting | Diameter Range: 1.100" - 5.000" (28mm - 127mm)

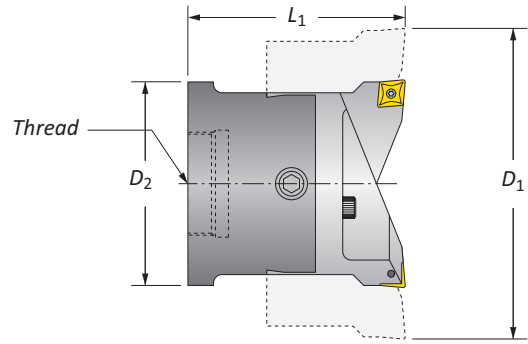

D ₁ Range	Boring Head			Part No.	Insert Holder Type		Inserts		
	L ₁	D ₂	Thread		Side 1	Side 2	IC	T ₁	Style
1.100 - 1.500	1.870	1.00	7/8-20	CT1000-0	Zero Lead	Zero Lead	0.250	0.094	◇ CP or CC
1.100 - 1.500	1.900	1.00	7/8-20	CT1000-1	Standard	Standard	0.250	0.094	◇ CP or CC
1.100 - 1.500	1.900	1.00	7/8-20	CT1000-2	Standard	Short	0.250	0.094	◇ CP or CC
1.400 - 1.900	1.870	1.25	7/8-20	CT1250-0	Zero Lead	Zero Lead	0.250	0.094	◇ CP or CC
1.400 - 1.900	1.900	1.25	7/8-20	CT1250-1	Standard	Standard	0.250	0.094	◇ CP or CC
1.400 - 1.900	1.900	1.25	7/8-20	CT1250-2	Standard	Short	0.250	0.094	◇ CP or CC
1.600 - 2.500	2.570	1.50	7/8-20	CT1500-0	Zero Lead	Zero Lead	0.375	0.156	◇ CP or CC
i 1.600 - 2.500	2.600	1.50	7/8-20	CT1500-1	Standard	Standard	0.375	0.156	◇ CP or CC
1.600 - 2.500	2.600	1.50	7/8-20	CT1500-2	Standard	Short	0.375	0.156	◇ CP or CC
2.100 - 3.100	2.470	2.00	7/8-20	CT2000-0	Zero Lead	Zero Lead	0.375	0.156	◇ CP or CC
2.100 - 3.100	2.500	2.00	7/8-20	CT2000-1	Standard	Standard	0.375	0.156	◇ CP or CC
2.100 - 3.100	2.500	2.00	7/8-20	CT2000-2	Standard	Short	0.375	0.156	◇ CP or CC
3.100 - 5.000	3.170	3.00	1-1/2-18	CT3000-0	Zero Lead	Zero Lead	0.375	0.156	◇ CP or CC
3.100 - 5.000	3.200	3.00	1-1/2-18	CT3000-1	Standard	Standard	0.375	0.156	◇ CP or CC
3.100 - 5.000	3.200	3.00	1-1/2-18	CT3000-2	Standard	Short	0.375	0.156	◇ CP or CC
Imperial (in) = 0.001" adjustment on diameter									
Metric (mm) = 0.02mm adjustment on diameter									
28 - 38	47	25	7/8-20	CT025M-0	Zero Lead	Zero Lead	6.35	2.38	◇ CP or CC
28 - 38	48	25	7/8-20	CT025M-1	Standard	Standard	6.35	2.38	◇ CP or CC
28 - 38	48	25	7/8-20	CT025M-2	Standard	Short	6.35	2.38	◇ CP or CC
36 - 48	47	32	7/8-20	CT032M-0	Zero Lead	Zero Lead	6.35	2.38	◇ CP or CC
36 - 48	48	32	7/8-20	CT032M-1	Standard	Standard	6.35	2.38	◇ CP or CC
36 - 48	48	32	7/8-20	CT032M-2	Standard	Short	6.35	2.38	◇ CP or CC
41 - 63	65	38	7/8-20	CT038M-0	Zero Lead	Zero Lead	9.53	3.96	◇ CP or CC
m 41 - 63	66	38	7/8-20	CT038M-1	Standard	Standard	9.53	3.96	◇ CP or CC
41 - 63	66	38	7/8-20	CT038M-2	Standard	Short	9.53	3.96	◇ CP or CC
54 - 78	63	50	7/8-20	CT050M-0	Zero Lead	Zero Lead	9.53	3.96	◇ CP or CC
54 - 78	64	50	7/8-20	CT050M-1	Standard	Standard	9.53	3.96	◇ CP or CC
54 - 78	64	50	7/8-20	CT050M-2	Standard	Short	9.53	3.96	◇ CP or CC
79 - 127	80	76	1-1/2-18	CT076M-0	Zero Lead	Zero Lead	9.53	3.96	◇ CP or CC
79 - 127	81	76	1-1/2-18	CT076M-1	Standard	Standard	9.53	3.96	◇ CP or CC
79 - 127	81	76	1-1/2-18	CT076M-2	Standard	Short	9.53	3.96	◇ CP or CC

Imperial (in) = 0.001" adjustment on diameter
Metric (mm) = 0.02mm adjustment on diameter

Notes:

- CTXXXX-0 units have a 0° lead angle = produce flat bottom
- CTXXXX-1 and -2 units have a 5° lead angle
- CTXXXX-2 units can be offset to remove twice the amount of material (as illustrated)

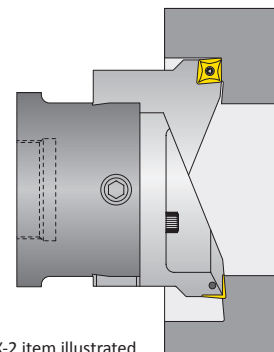

CTXXXX-2 item illustrated

B20: 78 - 79

Key on B20: 1

B20: 42 - 46

B20: 24

B20: 60 - 63

B20: 82

i = Imperial (in)
m = Metric (mm)
Inserts sold separately

Cri-Twin® Boring Head Replacement Parts

Standard Adjusting

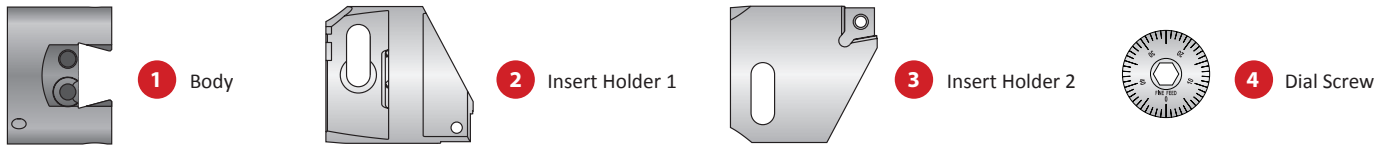

Head Part No.	Hardware Kit	Components				Torx Screw	Torx Wrench
		1	2	3	4		
CT1000-0	CT1000-HDW	CT1000-BD	CT1000ZRO-IH	CT1000ZRO-IH	DS-MDB0750	TXS-116-1	8T-7FL
CT1000-1	CT1000-HDW	CT1000-BD	CT1000STD-IH	CT1000STD-IH	DS-MDB0750	TXS-116-1	8T-7FL
CT1000-2	CT1000-HDW	CT1000-BD	CT1000STD-IH	CT1000SHT-IH	DS-MDB0750	TXS-116-1	8T-7FL
CT1250-0	CT1250-HDW	CT1250-BD	CT1250ZRO-IH	CT1250ZRO-IH	DS-CT1250	TXS-116-1	8T-7FL
CT1250-1	CT1250-HDW	CT1250-BD	CT1250STD-IH	CT1250STD-IH	DS-CT1250	TXS-116-1	8T-7FL
CT1250-2	CT1250-HDW	CT1250-BD	CT1250STD-IH	CT1250SHT-IH	DS-CT1250	TXS-116-1	8T-7FL
i CT1500-0	CT1500-HDW	CT1500-BD	CT1500ZRO-IH	CT1500ZRO-IH	DS-CT1500	TXS-009-1	8T-15
i CT1500-1	CT1500-HDW	CT1500-BD	CT1500STD-IH	CT1500STD-IH	DS-CT1500	TXS-009-1	8T-15
i CT1500-2	CT1500-HDW	CT1500-BD	CT1500STD-IH	CT1500SHT-IH	DS-CT1500	TXS-009-1	8T-15
CT2000-0	CT2000-HDW	CT2000-BD	CT2000ZRO-IH	CT2000ZRO-IH	DS-CT2000	TXS-009-1	8T-15
CT2000-1	CT2000-HDW	CT2000-BD	CT2000STD-IH	CT2000STD-IH	DS-CT2000	TXS-009-1	8T-15
CT2000-2	CT2000-HDW	CT2000-BD	CT2000SHT-IH	CT2000STD-IH	DS-CT2000	TXS-009-1	8T-15
CT3000-0	CT3000-HDW	CT3000-BD	CT3000ZRO-IH	CT3000ZRO-IH	DS-CT3000	TXS-009-1	8T-15
CT3000-1	CT3000-HDW	CT3000-BD	CT3000STD-IH	CT3000STD-IH	DS-CT3000	TXS-009-1	8T-15
CT3000-2	CT3000-HDW	CT3000-BD	CT3000STD-IH	CT3000SHT-IH	DS-CT3000	TXS-009-1	8T-15
m CT025M-0	CT025M-HDW	CT025M-BD	CT025MZRO-IH	CT025MZRO-IH	DS-MDB20M	TXS-116-1	8T-7FL
m CT025M-1	CT025M-HDW	CT025M-BD	CT025MSTD-IH	CT025MSTD-IH	DS-MDB20M	TXS-116-1	8T-7FL
m CT025M-2	CT025M-HDW	CT025M-BD	CT025MSTD-IH	CT025MSHT-IH	DS-MDB20M	TXS-116-1	8T-7FL
m CT032M-0	CT032M-HDW	CT032M-BD	CT032MZRO-IH	CT032MZRO-IH	DS-CT032M	TXS-116-1	8T-7FL
m CT032M-1	CT032M-HDW	CT032M-BD	CT032MSTD-IH	CT032MSTD-IH	DS-CT032M	TXS-116-1	8T-7FL
m CT032M-2	CT032M-HDW	CT032M-BD	CT032MSTD-IH	CT032MSHT-IH	DS-CT032M	TXS-116-1	8T-7FL
m CT038M-0	CT038M-HDW	CT038M-BD	CT038MZRO-IH	CT038MZRO-IH	DS-CT038M	TXS-009-1	8T-15
m CT038M-1	CT038M-HDW	CT038M-BD	CT038MSTD-IH	CT038MSTD-IH	DS-CT038M	TXS-009-1	8T-15
m CT038M-2	CT038M-HDW	CT038M-BD	CT038MSTD-IH	CT038MSHT-IH	DS-CT038M	TXS-009-1	8T-15
m CT050M-0	CT050M-HDW	CT050M-BD	CT050MZRO-IH	CT050MZRO-IH	DS-CT050M	TXS-009-1	8T-15
m CT050M-1	CT050M-HDW	CT050M-BD	CT050MSTD-IH	CT050MSTD-IH	DS-CT050M	TXS-009-1	8T-15
m CT050M-2	CT050M-HDW	CT050M-BD	CT050MSTD-IH	CT050MSHT-IH	DS-CT050M	TXS-009-1	8T-15
m CT076M-0	CT076M-HDW	CT076M-BD	CT076MZRO-IH	CT076MZRO-IH	DS-CT076M	TXS-009-1	8T-15
m CT076M-1	CT076M-HDW	CT076M-BD	CT076MSTD-IH	CT076MSTD-IH	DS-CT076M	TXS-009-1	8T-15
m CT076M-2	CT076M-HDW	CT076M-BD	CT076MSTD-IH	CT076MSHT-IH	DS-CT076M	TXS-009-1	8T-15

i = Imperial (in)**m** = Metric (mm)

Screws sold in multiples of 10

Cri-Bore® Boring Heads

Standard Adjusting | Diameter Range: 1.050" - 7.380" (27mm - 187mm)

A
DRILLING

B
BORING

C
REAMING

D
BURNISHING

F
THREADING

X
SPECIALS

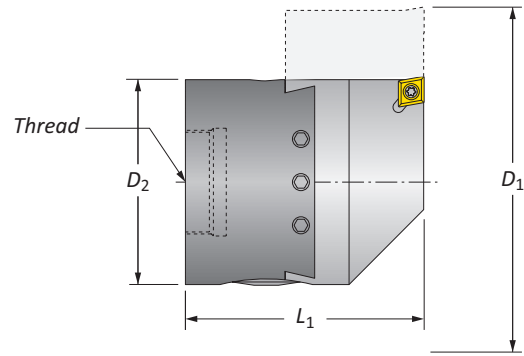

D ₁ Range	Boring Head			Part No.	Pin Spanner Wrench	Insert		
	L ₁	D ₂	Thread			IC	T ₁	Style
1.050 - 1.320	1.980	1.000	7/8-20	CB1000-TP	CB1000-PSW	0.250	0.094	▲ TP
1.050 - 1.320	1.980	1.000	7/8-20	CB1000-CP	CB1000-PSW	0.250	0.094	◆ CP or CC
1.300 - 1.600	2.210	1.250	7/8-20	CB1250-TP	CB1250-PSW	0.250	0.094	▲ TP
1.300 - 1.600	2.210	1.250	7/8-20	CB1250-CP	CB1250-PSW	0.250	0.094	◆ CP or CC
1.585 - 2.700	2.480	1.500	7/8-20	CB1500-TP	CB1500-PSW	0.375	0.125	▲ TP
1.585 - 2.700	2.480	1.500	7/8-20	CB1500-CP	CB1500-PSW	0.375	0.156	◆ CP or CC
i 2.060 - 3.320	2.735	2.000	7/8-20	CB2000-TP	CB2000-PSW	0.375	0.125	▲ TP
2.060 - 3.320	2.735	2.000	7/8-20	CB2000-CP	CB2000-PSW	0.375	0.156	◆ CP or CC
3.065 - 5.065	3.465	3.000	1-1/2-18	CB3000-TP	CB3000-PSW	0.375	0.125	▲ TP
3.065 - 5.065	3.465	3.000	1-1/2-18	CB3000-CP	CB3000-PSW	0.375	0.156	◆ CP or CC
4.100 - 7.300	3.970	4.000	1-1/2-18	CB4000-TP	CB4000-PSW	0.375	0.156	▲ TP
4.180 - 7.380	3.970	4.000	1-1/2-18	CB4000-CP	CB4000-PSW	0.500	0.188	◆ CP or CC
27 - 33	50	25	7/8-20	CB025M-TP	CB1000-PSW	6.35	2.38	▲ TP
27 - 33	50	25	7/8-20	CB025M-CP	CB1000-PSW	6.35	2.38	◆ CP or CC
33 - 41	56	32	7/8-20	CB032M-TP	CB1250-PSW	6.35	2.38	▲ TP
33 - 41	56	32	7/8-20	CB032M-CP	CB1250-PSW	6.35	2.38	◆ CP or CC
41 - 68	63	38	7/8-20	CB038M-TP	CB1500-PSW	9.53	3.18	▲ TP
41 - 68	63	38	7/8-20	CB038M-CP	CB1500-PSW	9.53	3.96	◆ CP or CC
53 - 84	69	50	7/8-20	CB050M-TP	CB2000-PSW	9.53	3.18	▲ TP
53 - 84	69	50	7/8-20	CB050M-CP	CB2000-PSW	9.53	3.96	◆ CP or CC
78 - 128	88	76	1-1/2-18	CB076M-TP	CB3000-PSW	9.53	3.18	▲ TP
78 - 128	88	76	1-1/2-18	CB076M-CP	CB3000-PSW	9.53	3.96	◆ CP or CC
104 - 185	101	101	1-1/2-18	CB101M-TP	CB4000-PSW	9.53	3.18	▲ TP
106 - 187	101	101	1-1/2-18	CB101M-CP	CB4000-PSW	12.70	4.76	◆ CP or CC

Imperial (in) = 0.001" adjustment on diameter
Metric (mm) = 0.02mm adjustment on diameter

B20: 80 - 81

B20: 42 - 46

B20: 24

B20: 60 - 67

B20: 83

i = Imperial (in)
m = Metric (mm)
Inserts sold separately

Cri-Bore® Boring Head Replacement Parts

Standard Adjusting

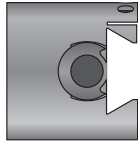

1 Body

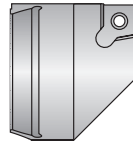

2 Insert Holder



3 Dial Screw

Head Part No.	Hardware Kit	Components				
		1	2	3	Torx Screw	Torx Wrench
CB1000-TP	CB1000-HDW	CB1000-BD	CB1000TP-IH	DS-MDB1000	TXS-116-1	8T-7
CB1000-CP	CB1000-HDW	CB1000-BD	CB1000CP-IH	DS-MDB1000	TXS-116-1	8T-7
CB1250-TP	CB1250-HDW	CB1250-BD	CB1250TP-IH	DS-MDB1000	TXS-116-1	8T-7
CB1250-CP	CB1250-HDW	CB1250-BD	CB1250CP-IH	DS-MDB1000	TXS-116-1	8T-7
CB1500-TP	CB1500-HDW	CB1500-BD	CB1500TP-IH	DS-CB2	TXS-100-1	8T-20
CB1500-CP	CB1500-HDW	CB1500-BD	CB1500CP-IH	DS-CB2	TXS-009-1	8T-15
CB2000-TP	CB2000-HDW	CB2000-BD	CB2000TP-IH	DS-CB2	TXS-100-1	8T-20
CB2000-CP	CB2000-HDW	CB2000-BD	CB2000CP-IH	DS-CB2	TXS-009-1	8T-15
CB3000-TP	CB3000-HDW	CB3000-BD	CB3000TP-IH	DS-CB3	TXS-100-1	8T-20
CB3000-CP	CB3000-HDW	CB3000-BD	CB3000CP-IH	DS-CB3	TXS-009-1	8T-15
CB4000-TP	CB4000-HDW	CB4000-BD	CB4000TP-IH	DS-CB4	TXS-100-1	8T-15FL
CB4000-CP	CB4000-HDW	CB4000-BD	CB4000CP-IH	DS-CB4	TXS-119-1	8T-20FL
CB025M-TP	CB025M-HDW	CB025M-BD	CB025MTP-IH	DS-MDB25M	TXS-116-1	8T-7
CB025M-CP	CB025M-HDW	CB025M-BD	CB025MCP-IH	DS-MDB25M	TXS-116-1	8T-7
CB032M-TP	CB032M-HDW	CB032M-BD	CB032MTP-IH	DS-MDB32M	TXS-116-1	8T-7
CB032M-CP	CB032M-HDW	CB032M-BD	CB032MCP-IH	DS-MDB32M	TXS-116-1	8T-7
CB038M-TP	CB038M-HDW	CB038M-BD	CB038MTP-IH	DS-CB050M	TXS-100-1	8T-20
CB038M-CP	CB038M-HDW	CB038M-BD	CB038MCP-IH	DS-CB050M	TXS-009-1	8T-15
CB050M-TP	CB050M-HDW	CB050M-BD	CB050MTP-IH	DS-CB050M	TXS-100-1	8T-20
CB050M-CP	CB050M-HDW	CB050M-BD	CB050MCP-IH	DS-CB050M	TXS-009-1	8T-15
CB076M-TP	CB076M-HDW	CB076M-BD	CB076MTP-IH	DS-CB076M	TXS-100-1	8T-20
CB076M-CP	CB076M-HDW	CB076M-BD	CB076MCP-IH	DS-CB076M	TXS-009-1	8T-15
CB101M-TP	CB101M-HDW	CB101M-BD	CB101MTP-IH	DS-CB101M	TXS-100-1	8T-15FL
CB101M-CP	CB101M-HDW	CB101M-BD	CB101MCP-IH	DS-CB101M	TXS-119-1	8T-20FL

i = Imperial (in)

m = Metric (mm)

Screws sold in multiples of 10

A **Cri-Bore® Boring Heads**

Micro Adjusting | Diameter Range: 1.050" - 5.065" (27mm - 128mm)

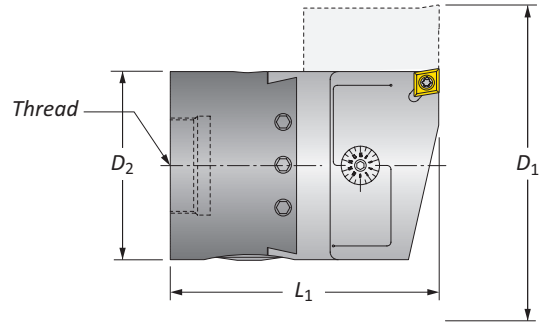

D ₁ Range	Boring Head			Part No.	 Pin Spanner Wrench	Insert			
	L ₁	D ₂	Thread			IC	T ₁	Style	
1.050 - 1.320	2.580	1.000	7/8-20	CB1000-TPMA	CB1000-PSW	0.250	0.094	▲ TP	
1.050 - 1.320	2.580	1.000	7/8-20	CB1000-CPMA	CB1000-PSW	0.250	0.094	◆ CP or CC	
1.300 - 1.600	2.810	1.250	7/8-20	CB1250-TPMA	CB1250-PSW	0.250	0.094	▲ TP	
1.300 - 1.600	2.810	1.250	7/8-20	CB1250-CPMA	CB1250-PSW	0.250	0.094	◆ CP or CC	
1.585 - 2.700	3.180	1.500	7/8-20	CB1500-TPMA	CB1500-PSW	0.375	0.125	▲ TP	
1.585 - 2.700	3.180	1.500	7/8-20	CB1500-CPMA	CB1500-PSW	0.375	0.156	◆ CP or CC	
2.060 - 3.320	3.530	2.000	7/8-20	CB2000-TPMA	CB2000-PSW	0.375	0.125	▲ TP	
2.060 - 3.320	3.530	2.000	7/8-20	CB2000-CPMA	CB2000-PSW	0.375	0.156	◆ CP or CC	
3.065 - 5.065	4.090	3.000	1-1/2-18	CB3000-TPMA	CB3000-PSW	0.375	0.125	▲ TP	
3.065 - 5.065	4.090	3.000	1-1/2-18	CB3000-CPMA	CB3000-PSW	0.375	0.156	◆ CP or CC	
i									
27 - 33	65	25	7/8-20	CB025M-TPMA	CB1000-PSW	6.35	2.38	▲ TP	
27 - 33	65	25	7/8-20	CB025M-CPMA	CB1000-PSW	6.35	2.38	◆ CP or CC	
33 - 41	71	32	7/8-20	CB032M-TPMA	CB1250-PSW	6.35	2.38	▲ TP	
33 - 41	71	32	7/8-20	CB032M-CPMA	CB1250-PSW	6.35	2.38	◆ CP or CC	
m									
41 - 68	81	38	7/8-20	CB038M-TPMA	CB1500-PSW	9.53	3.18	▲ TP	
41 - 68	81	38	7/8-20	CB038M-CPMA	CB1500-PSW	9.53	3.96	◆ CP or CC	
53 - 84	90	50	7/8-20	CB050M-TPMA	CB2000-PSW	9.53	3.18	▲ TP	
53 - 84	90	50	7/8-20	CB050M-CPMA	CB2000-PSW	9.53	3.96	◆ CP or CC	
78 - 128	104	76	1-1/2-18	CB076M-TPMA	CB3000-PSW	9.53	3.18	▲ TP	
78 - 128	104	76	1-1/2-18	CB076M-CPMA	CB3000-PSW	9.53	3.96	◆ CP or CC	

Imperial (in) = 0.00005" adjustment on diameter
Metric (mm) = 0.001mm adjustment on diameter

B

BORING

C

REAMING

D

BURNISHING

F

THREADING

X

SPECIALS

B20: 80 - 81

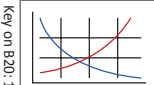

B20: 42 - 46

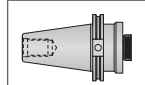

B20: 24

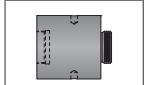

B20: 60 - 67

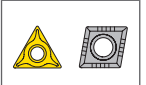

B20: 83



i = Imperial (in)
m = Metric (mm)
Inserts sold separately

Cri-Bore® Boring Head Replacement Parts

Micro Adjusting

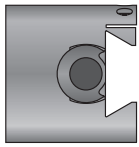

1 Body

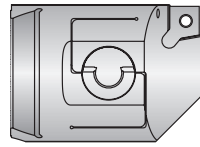

2 Insert Holder



3 Dial Screw



4 Micro Dial Screw

Head Part No.	Hardware Kit	Components				Wedge	Torx Screw	Torx Wrench
		1	2	3	4			
CB1000-TPMA	CB1000-HDW	CB1000-BD	CB1000TPMA-IH	DS-MDB1000	DS-MA1500	MAW-1000	TXS-116-1	8T-7
CB1000-CPMA	CB1000-HDW	CB1000-BD	CB1000CPMA-IH	DS-MDB1000	DS-MA1500	MAW-1000	TXS-116-1	8T-7
CB1250-TPMA	CB1250-HDW	CB1250-BD	CB1250TPMA-IH	DS-MDB1000	DS-MA1500	MAW-1000	TXS-116-1	8T-7
CB1250-CPMA	CB1250-HDW	CB1250-BD	CB1250CPMA-IH	DS-MDB1000	DS-MA1500	MAW-1000	TXS-100-1	8T-20
CB1500-TPMA	CB1500-HDW	CB1500-BD	CB1500TPMA-IH	DS-CB2	DS-MA2500	MAW-2000	TXS-100-1	8T-20
CB1500-CPMA	CB1500-HDW	CB1500-BD	CB1500CPMA-IH	DS-CB2	DS-MA2500	MAW-2000	TXS-009-1	8T-15
CB2000-TPMA	CB2000-HDW	CB2000-BD	CB2000TPMA-IH	DS-CB2	DS-MA2500	MAW-2000	TXS-100-1	8T-20
CB2000-CPMA	CB2000-HDW	CB2000-BD	CB2000CPMA-IH	DS-CB2	DS-MA2500	MAW-2000	TXS-009-1	8T-15
CB3000-TPMA	CB3000-HDW	CB3000-BD	CB3000TPMA-IH	DS-CB3	DS-MA2500	MAW-2000	TXS-100-1	8T-20
CB3000-CPMA	CB3000-HDW	CB3000-BD	CB3000CPMA-IH	DS-CB3	DS-MA2500	MAW-2000	TXS-009-1	8T-15
CB025M-TPMA	CB025M-HDW	CB025M-BD	CB025MTPMA-IH	DS-MDB25M	DS-MA038M	MAW-1000	TXS-116-1	8T-7
CB025M-CPMA	CB025M-HDW	CB025M-BD	CB025MCPMA-IH	DS-MDB25M	DS-MA038M	MAW-1000	TXS-116-1	8T-7
CB032M-TPMA	CB032M-HDW	CB032M-BD	CB032MTPMA-IH	DS-MDB32M	DS-MA038M	MAW-1000	TXS-116-1	8T-7
CB032M-CPMA	CB032M-HDW	CB032M-BD	CB032MCPMA-IH	DS-MDB32M	DS-MA038M	MAW-1000	TXS-116-1	8T-7
CB038M-TPMA	CB038M-HDW	CB038M-BD	CB038MTPMA-IH	DS-CB050M	DS-MA064M	MAW-2000	TXS-100-1	8T-20
CB038M-CPMA	CB038M-HDW	CB038M-BD	CB038MCPMA-IH	DS-CB050M	DS-MA064M	MAW-2000	TXS-009-1	8T-15
CB050M-TPMA	CB050M-HDW	CB050M-BD	CB050MTPMA-IH	DS-CB050M	DS-MA064M	MAW-2000	TXS-100-1	8T-20
CB050M-CPMA	CB050M-HDW	CB050M-BD	CB050MCPMA-IH	DS-CB050M	DS-MA064M	MAW-2000	TXS-009-1	8T-15
CB076M-TPMA	CB076M-HDW	CB076M-BD	CB076MTPMA-IH	DS-CB076M	DS-MA064M	MAW-2000	TXS-100-1	8T-20
CB076M-CPMA	CB076M-HDW	CB076M-BD	CB076MCPMA-IH	DS-CB076M	DS-MA064M	MAW-2000	TXS-009-1	8T-15

i = Imperial (in)

m = Metric (mm)

Screws sold in multiples of 10

Large Cri-Bore® System

Bore ID Range: 5.000" - 12.125" (127.0mm - 307.9mm) | Bore OD Range: 0.710" - 7.830" (18.1mm - 198.8mm)

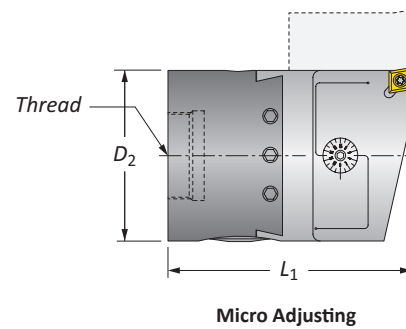
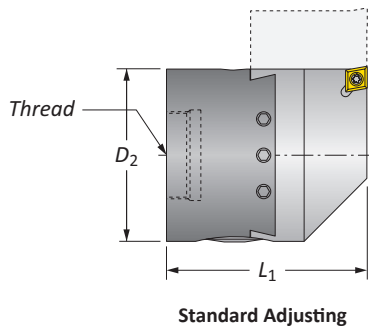
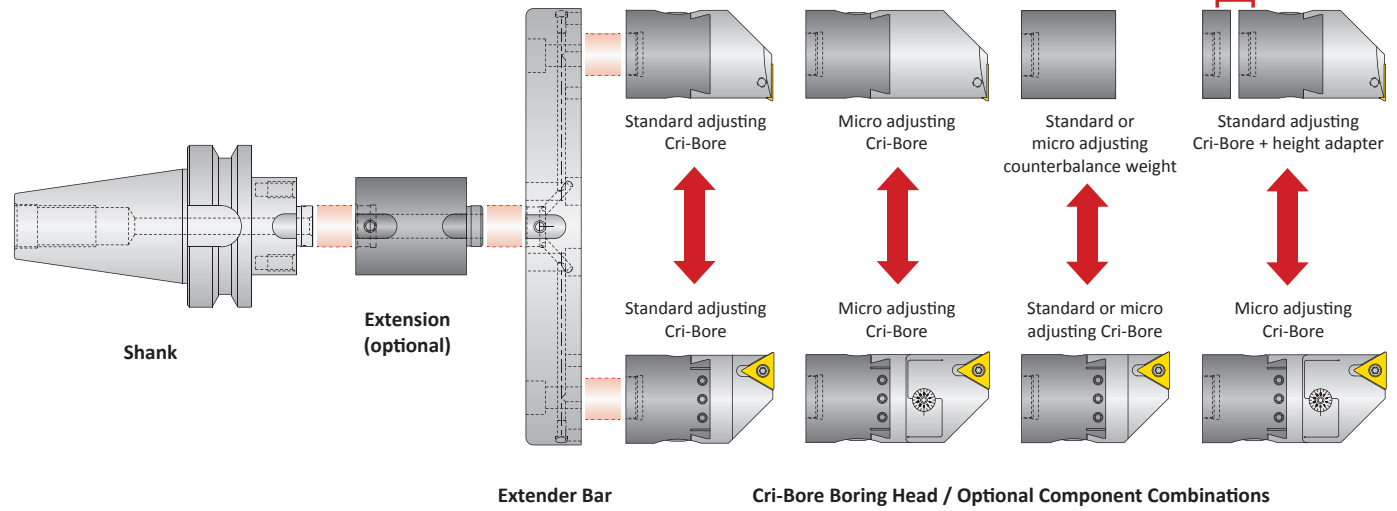

Cri-Bore Boring Heads

Adjustment	Boring Head				Insert			
	L_1	D_2	Thread	Part No.	IC	T_1	Style	
i	Standard	2.480	1.500	7/8-20	CB1500-TP	0.375	0.125	▲ TP
	Standard	2.480	1.500	7/8-20	CB1500-CP	0.375	0.156	◆ CP or CC
	Micro	3.180	1.500	7/8-20	CB1500-TPMA	0.375	0.125	▲ TP
	Micro	3.180	1.500	7/8-20	CB1500-CPMA	0.375	0.156	◆ CP or CC
m	Standard	63	38	7/8-20	CB038M-TP	0.375	0.125	▲ TP
	Standard	63	38	7/8-20	CB038M-CP	0.375	0.156	◆ CP or CC
	Micro	81	38	7/8-20	CB038M-TPMA	0.375	0.125	▲ TP
	Micro	81	38	7/8-20	CB038M-CPMA	0.375	0.156	◆ CP or CC

Imperial (in) Standard = 0.001" adjustment on diameter
Imperial (in) Micro = 0.00005" adjustment on diameter

Metric (mm) Standard = 0.02mm adjustment on diameter
Metric (mm) Micro = 0.001mm adjustment on diameter

Large Cri-Bore Extensions

Dimensions	Part No.		
	D_1	L_1	
i	1.50	1.50	LCB1500-IA1500
	1.50	3.00	LCB1500-IA3000
	1.50	4.50	LCB1500-IA4500

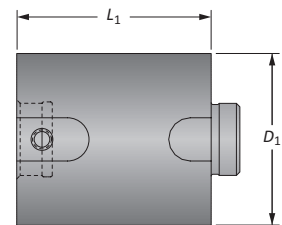

NOTICE: Only one extension can be used per boring head. Extensions cannot be combined.

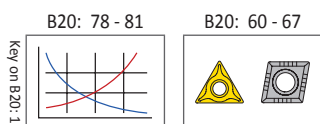

i = Imperial (in)
m = Metric (mm)
Inserts sold separately

Large Cri-Bore® System

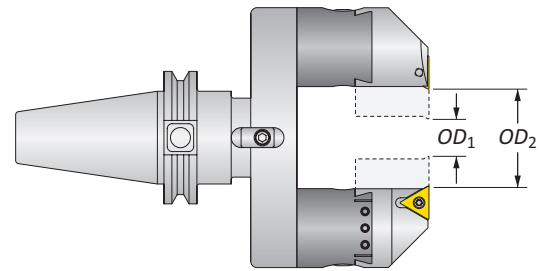
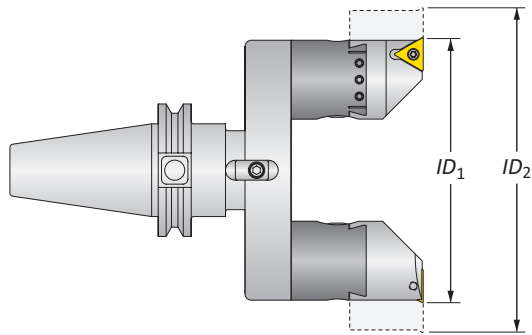

Large Cri-Bore Extender Bars

Imperial (in)				Metric (mm)				Part No.
ID_1	ID_2	OD_1	OD_2	ID_1	ID_2	OD_1	OD_2	
5.000	6.125	0.710	1.830	127.0	155.5	18.1	46.4	LCB1500-56EBK
6.000	7.125	1.710	2.830	152.4	180.9	43.5	71.8	LCB1500-67EBK
7.000	8.125	2.710	3.830	177.8	206.3	68.9	97.2	LCB1500-78EBK
8.000	9.125	3.710	4.830	203.2	231.7	94.3	122.6	LCB1500-89EBK
9.000	10.125	4.710	5.830	228.6	257.1	119.7	148.0	LCB1500-910EBK
10.000	11.125	5.710	6.830	254.0	282.5	145.1	173.4	LCB1500-1011EBK
11.000	12.125	6.710	7.830	279.4	307.9	170.5	198.8	LCB1500-1112EBK

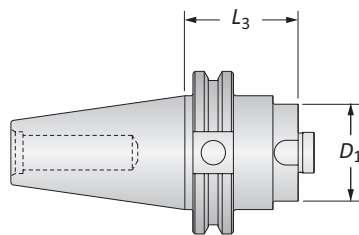

CV40 Shank

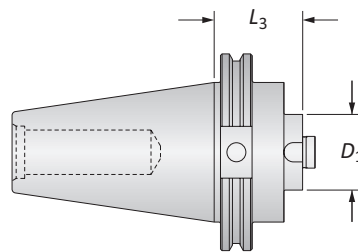

CV50 Shank

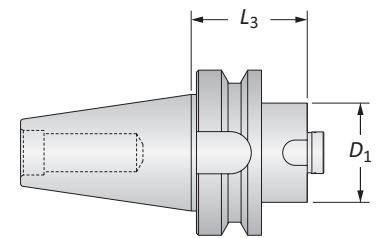

BT40 Shank

Large Cri-Bore Shanks

	Shank		Part No.
	L_3	Taper	
i	1.75	40 V-Flange	LCB1500-CV40
	1.75	50 V-Flange	LCB1500-CV50
	1.75	40 BT-Flange	LCB1500-BT40
	1.75	HSK63A	LCB1500-HSK63A

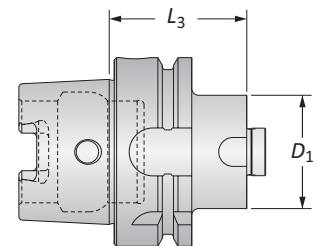

HSK63 Shank

Large Cri-Bore Optional Components

Part No.	Description	Notes
LCB1500-CBW	Counterbalance weight	Recommended when using a single CB1500 (standard adjusting) boring head
LCB1500-CBWTA	Counterbalance weight	Recommended when using a single CB1500-MA (micro-adjusting) boring head
LCB1500-HA	Height adapter	Required when using a CB1500 boring head in combination with a CB1500-MA boring head

NOTICE: The Large Cri-Bore (LCB) System can be used with a single Cri-Bore boring head. This configuration will result in increased imbalance and will affect the tool's performance and/or spindle damage. A counterbalance weight is recommended to balance the tool. Factory technical assistance is available through our Application Engineering department.

i = Imperial (in)
m = Metric (mm)

CB Style Boring Heads

Standard Adjusting | Micro Adjusting | Bore Diameter Range: 0.050" - 21.500" (3mm - 341mm)

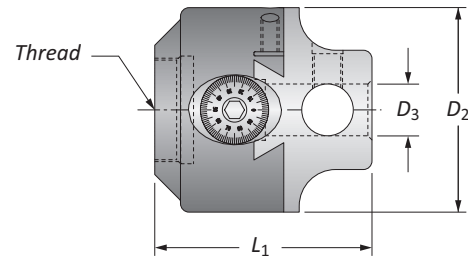

Standard Adjusting

Bore Diameter Range			Boring Head							
Center Hole	Outboard Hole	Cross Hole*	D ₂	D ₃	L ₁	Thread	Offset	Part No.	Pin Spanner Wrench	Cross Hole Bar
0.050 - 1.625	-	-	1.500	0.375	2.500	7/8-20	0.562	CB-2375A	CB1500-PSW	-
0.050 - 1.625	-	-	1.500	0.500	2.500	7/8-20	0.562	CB-1500B	CB1500-PSW	-
0.050 - 1.750	1.312 - 3.000	2.875 - 6.687	2.000	0.375	2.406	7/8-20	0.625	CB-202A	CB2000-PSW	CHB-0500
0.050 - 1.750	1.312 - 3.000	2.875 - 6.687	2.000	0.500	2.406	7/8-20	0.625	CB-202B	CB2000-PSW	CHB-0500
0.050 - 3.250	2.375 - 5.125	4.937 - 11.000	3.000	0.750	3.156	1-1/2-18	1.000	CB-203D	CB3000-PSW	CHB-0750
0.050 - 4.500	3.000 - 7.000	5.625 - 13.437	4.000	1.000	3.867	1-1/2-18	1.625	CB-204E	CB4000-PSW	CHB-1000
1.750 - 5.750	5.500 - 9.500	9.093 - 21.500	6.000	1.500	5.500	2-1/4-10	2.000	CB-206F	-	CHB-1500
3.00 - 40.00	-	-	38.00	10.00	63.00	7/8-20	14.00	CB-038MA	CB1500-PSW	-
3.00 - 40.00	-	-	38.00	12.00	63.00	7/8-20	14.00	CB-038MB	CB1500-PSW	-
3.00 - 44.00	35.00 - 76.00	73.00 - 169.00	50.00	10.00	61.00	7/8-20	16.00	CB-050MA	CB2000-PSW	CHB-012M
3.00 - 44.00	35.00 - 76.00	73.00 - 169.00	50.00	12.00	61.00	7/8-20	16.00	CB-050MB	CB2000-PSW	CHB-012M
10.00 - 70.00	60.00 - 130.00	126.00 - 279.00	76.00	20.00	80.00	1-1/2-18	25.00	CB-076MD	CB3000-PSW	CHB-020M
10.00 - 113.00	76.00 - 178.00	143.00 - 341.00	101.00	25.00	95.00	1-1/2-18	41.00	CB-101ME	CB4000-PSW	CHB-025M

***NOTICE:** Cross hole bars should always be secured in the bar holder with at least two set screws

Imperial (in) = 0.001" adjustment on diameter

Metric (mm) = 0.02mm adjustment on diameter

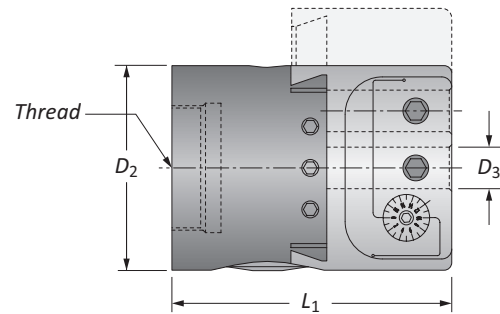

Micro Adjusting

Bore Diameter Range			Boring Head						
Center Hole	Outboard Hole	D ₂	D ₃	L ₁	Thread	Offset	Part No.	Pin Spanner Wrench	
0.050 - 1.625	1.000 - 2.500	1.500	0.375	3.000	7/8-20	0.562	CB-1500AMA	CB1000-PSW	
0.050 - 1.875	1.500 - 3.250	2.500	0.500	3.375	1-1/2-18	0.687	CB-2500BMA	CB2000-PSW	
0.050 - 2.375	2.375 - 5.125	3.000	0.750	3.375	1-1/2-18	1.000	CB-3000DMA	CB3000-PSW	
3.00 - 42.00	34.00 - 73.00	64.00	12.00	86.00	1-1/2-18	20.00	CB-064MBMA	CB2000-PSW	
10.00 - 73.00	60.00 - 130.00	76.00	20.00	86.00	1-1/2-18	25.00	CB-076MDMA	CB3000-PSW	

Imperial (in) = 0.00005" adjustment on diameter

Metric (mm) = 0.001mm adjustment on diameter

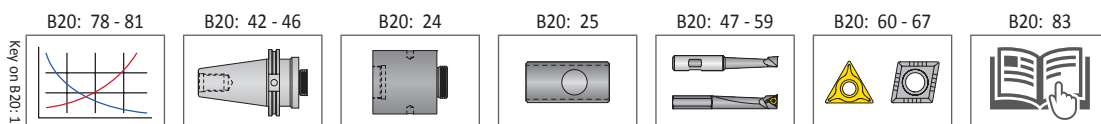

i = Imperial (in)
m = Metric (mm)

CB Style Boring Head Replacement Parts

Standard Adjusting | Micro Adjusting

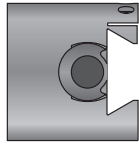

1 Body



2 Bar Holder



3 Dial Screw

Standard Adjusting

	Head Part No.	Hardware Kit	Components		
			1	2	3
i	CB-2375A	CB1500-HDW	CB1500-BD	MB152-BH	DS-CB2
	CB-1500B	CB1500-HDW	CB1500-BD	MB002-BH	DS-CB2
	CB-202A	CB2000-HDW	CB2000-BD	CB202A-BH	DS-CB2
	CB-202B	CB2000-HDW	CB2000-BD	CB202B-BH	DS-CB2
	CB-203D	CB3000-HDW	CB3000-BD	CB203D-BH	DS-CB3
	CB-204E	CB4000-HDW	CB4000-BD	CB204E-BH	DS-CB4
	CB-206F	CB6000-HDW	CB6000-BD	CB206F-BH	DS-CB206
m	CB-038MA	CB038M-HDW	CB038M-BD	CB038MA-BH	DS-CB050M
	CB-038MB	CB038M-HDW	CB038M-BD	CB038MB-BH	DS-CB050M
	CB-050MA	CB050M-HDW	CB050M-BD	CB050MA-BH	DS-CB050M
	CB-050MB	CB050M-HDW	CB050M-BD	CB050MB-BH	DS-CB050M
	CB-076MD	CB076M-HDW	CB076M-BD	CB076MD-BH	DS-CB076M
	CB-101ME	CB101M-HDW	CB101M-BD	CB101ME-BH	DS-CB101M

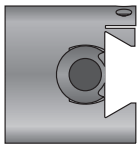

1 Body

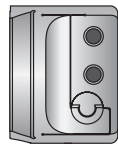

2 Bar Holder



3 Dial Screw



4 Micro Dial Screw

Micro Adjusting

	Head Part No.	Hardware Kit	Components				 Wedge
			1	2	3	4	
i	CB-1500AMA	CB1500-HDW	CB1500-BD	CB1500AMA-BH	DS-CB2	DS-MA1500	MAW-1500
	CB-2500BMA	CB2000-HDW	CB2500-BD	CB2500BMA-BH	DS-CB25	DS-MA2500	MAW-2500
	CB-3000DMA	CB3000-HDW	CB3000-BD	CB3000DMA-BH	DS-CB3	DS-MA2500	MAW-3000
m	CB-064MBMA	CB050M-HDW	CB064M-BD	CB064MBMA-BH	DS-CB064M	DS-MA064M	MAW-2000
	CB-076MDMA	CB076M-HDW	CB076M-BD	CB076MDMA-BH	DS-CB076M	DS-MA064M	MAW-2000

i = Imperial (in)
m = Metric (mm)

CB Style Boring Heads

Square Style | Slotted Style | Bore Diameter Range: 0.050" - 4.250"

A
DRILLING

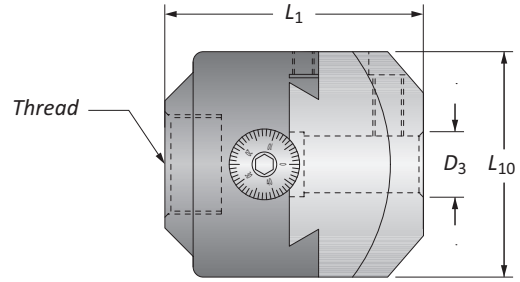

B
BORING

Square Style

		Boring Head					
		D_3	L_{10}	L_1	Thread	Offset	Part No.
i	0.050 - 1.625	0.500	1.50 SQ	2.250	7/8-20	0.526	SQ-1500B
	0.050 - 2.375	0.500	2.00 SQ	2.250	7/8-20	0.938	SQ-2000B
	0.500 - 4.250	0.750	3.00 SQ	2.937	1-1/2-18	1.500	SQ-3000D
	0.500 - 4.250	1.000	3.00 SQ	2.937	1-1/2-18	1.500	SQ-3000E

Imperial (in) = 0.001" adjustment on diameter

C
REAMING

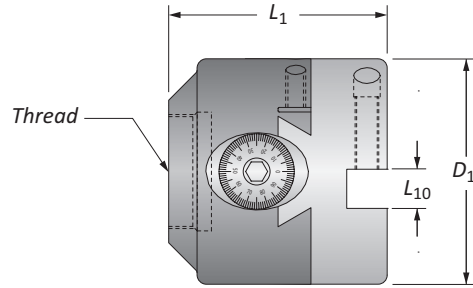

Slotted Style

		Boring Head					
		D_1	L_{10}	L_1	Thread	Offset	Part No.
i	2.00	0.375	2.406	7/8-20	0.625	CSL-202	
	3.00	0.500	2.875	1-1/2-18	1.000	CSL-203	
	4.00	0.750	3.375	1-1/2-18	1.625	CSL-204	

Imperial (in) = 0.001" adjustment on diameter

F
THREADING

X
SPECIALS

Key on B20: 1

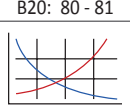
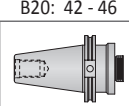
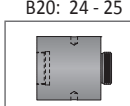
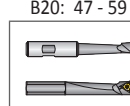
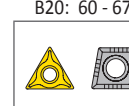
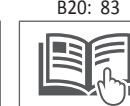
 B20: 80 - 81	 B20: 42 - 46	 B20: 24 - 25	 B20: 47 - 59	 B20: 60 - 67	 B20: 83
--	--	--	--	--	--

i = Imperial (in)
m = Metric (mm)

CB Style Boring Head Replacement Parts

Square Style | Slotted Style

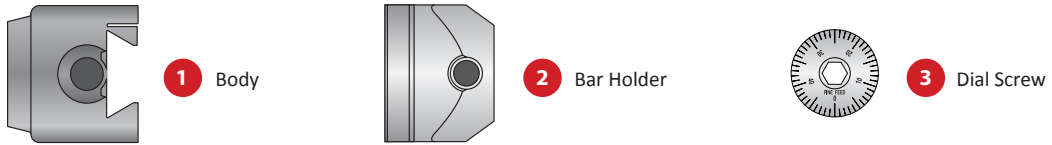

Square Style

	Head Part No.	Hardware Kit	Components		
			1	2	3
i	SQ-1500B	S1500-HDW	S1500-BD	S1500B-BH	DS-CB2
	SQ-2000B	S2000-HDW	S2000-BD	S2000B-BH	DS-CT3000
	SQ-3000D	S3000-HDW	S3000-BD	S3000D-BH	DS-CB4
	SQ-3000E	S3000-HDW	S3000-BD	S3000E-BH	DS-CB4

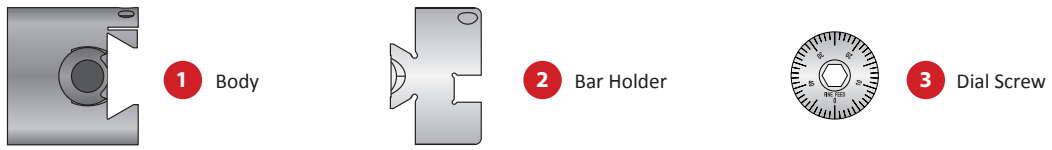

Slotted Style

	Head Part No.	Hardware Kit	Components		
			1	2	3
i	CSL-202	CB2000-HDW	CB2000-BD	SL202-BH	DS-CB2
	CSL-203	CB3000-HDW	CB3000-BD	SL203-BH	DS-CB3
	CSL-204	CB4000-HDW	CB4000-BD	SL204-BH	DS-CB4

i = Imperial (in)
m = Metric (mm)

Boring and Facing Heads

CNC Style | Manual Style | Bore Diameter Range: 0.050" - 10.625" (10.0mm - 288.0mm)

Standard feed: 0.003" per revolution
Fine feed: 0.0015" per revolution

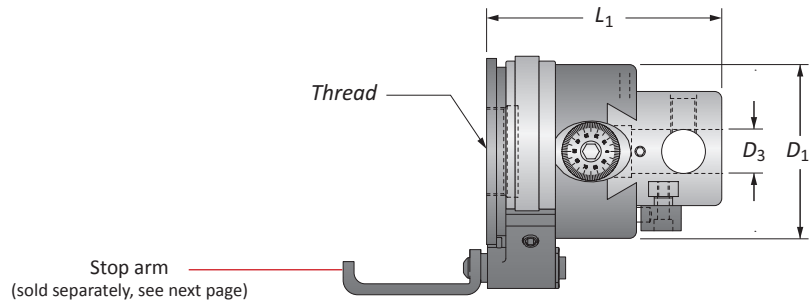

CNC Style

	Bore Diameter			Boring Head					Feed	Part No.
	Center Hole	Outboard Hole	Cross Hole*	D ₁	D ₃	L ₁	Thread	Offset		
i	0.050 - 2.875	2.375 - 4.750	4.937 - 10.625	3.000	0.750	3.875	1-1/2-18	0.812	Standard	BFC-300D
	0.050 - 2.875	2.375 - 4.750	4.937 - 10.625	3.000	0.750	3.875	1-1/2-18	0.812	Fine	BFC-300DFF
m	10.00 - 76.00	60.00 - 120.00	125.00 - 288.00	76.00	20.00	98.00	1-1/2-18	22.00	Standard	BFC-076MD
	10.00 - 76.00	60.00 - 120.00	125.00 - 288.00	76.00	20.00	98.00	1-1/2-18	22.00	Fine	BFC-076MDFF

***NOTICE:** Cross hole bars should always be secured in the bar holder with at least two set screws
 See stop arm options on following page
 See Boring and Facing boring bar option on following page
 Imperial (in) = 0.001" adjustment on diameter
 Metric (mm) = 0.02mm adjustment on diameter

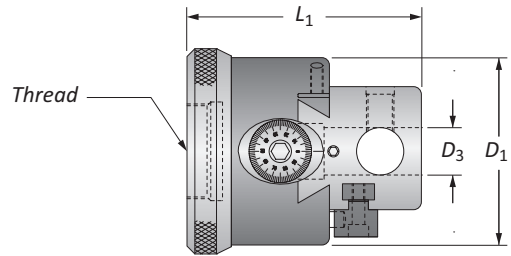

Standard feed: 0.08mm per revolution
Fine feed: 0.04mm per revolution

Manual Style

	Bore Diameter			Boring Head					Feed	Part No.
	Center Hole	Outboard Hole	Cross Hole*	D ₁	D ₃	L ₁	Thread	Offset		
i	0.050 - 2.875	2.375 - 4.750	4.937 - 10.625	3.000	0.750	3.875	1-1/2-18	0.812	Standard	BFM-300D
	0.050 - 2.875	2.375 - 4.750	4.937 - 10.625	3.000	0.750	3.875	1-1/2-18	0.812	Fine	BFM-300DFF
m	10.00 - 76.00	60.00 - 120.00	125.00 - 288.00	76.00	20.00	98.00	1-1/2-18	22.00	Standard	BFM-076MD
	10.00 - 76.00	60.00 - 120.00	125.00 - 288.00	76.00	20.00	98.00	1-1/2-18	22.00	Fine	BFM-076MDFF

***NOTICE:** Cross hole bars should always be secured in the bar holder with at least two set screws
 See Boring and Facing boring bar option on following page
 Imperial (in) = 0.001" adjustment on diameter
 Metric (mm) = 0.02mm adjustment on diameter

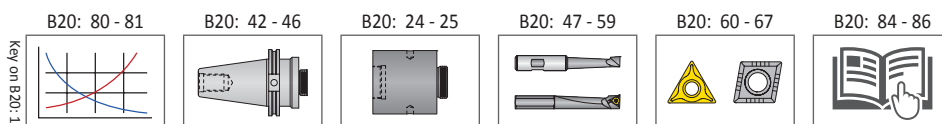

i = Imperial (in)
 m = Metric (mm)

A DRILLING
 B BORING
 C REAMING
 D BURNISHING
 E THREADING
 X SPECIALS



Boring and Facing Heads

CNC Style | Stop Arms

Stop Arms

Machine	Stop Arm Type	Part No.
-	Blank	BFC-300DSAB
Fadal	V-40	BFC-300DSAFV40
Fadal	BT-40	BFC-300DSAFBT40
HAAS	V-40	BFC-300DSAHV40
HAAS	BT-40	BFC-300DSAHBT40

Blank

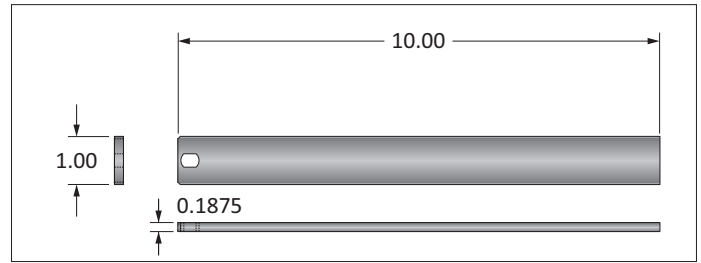

Fadal V-40

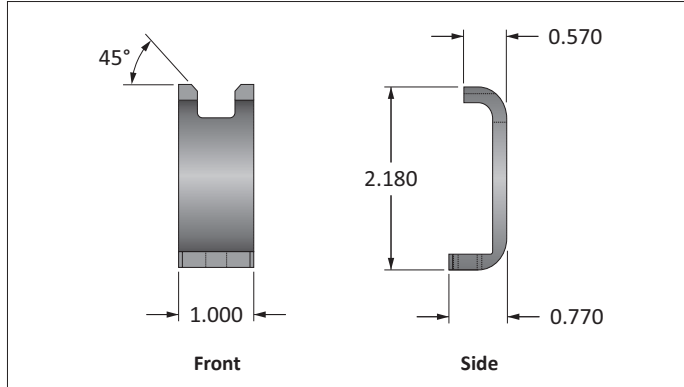

Fadal BT-40

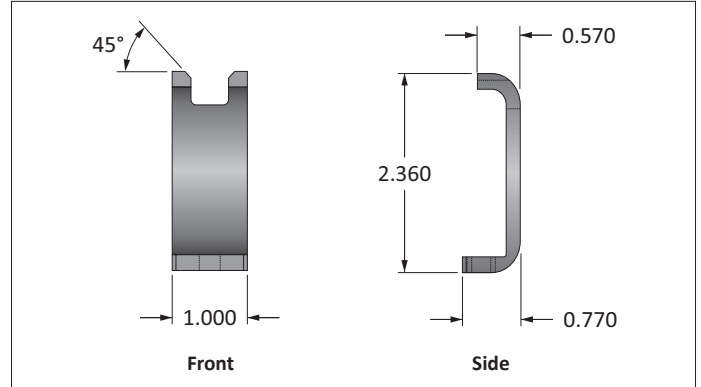

HAAS V-40

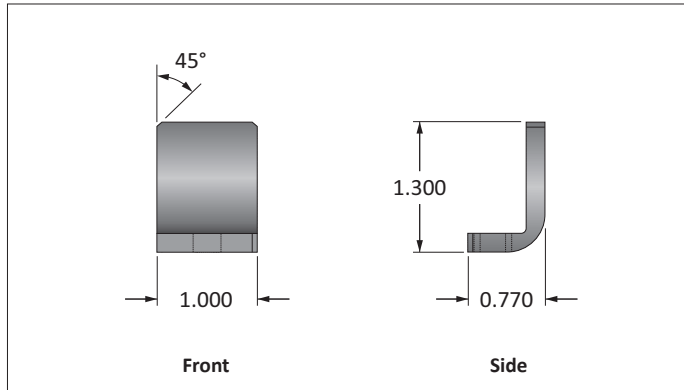

HAAS BT-40

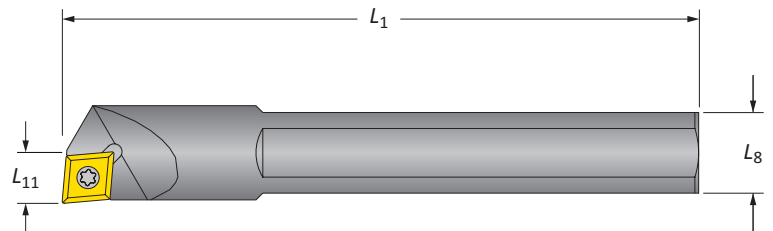
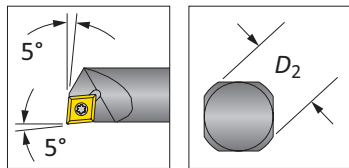
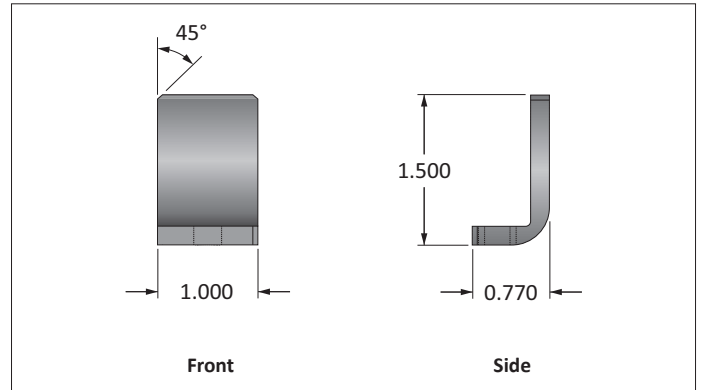

Boring and Facing Boring Bar

Boring Bar				Part No.	IC	Insert	
L ₁₁	L ₁	L ₈	D ₂			T ₁	Style
0.406	5.00	0.640	0.750Ø	BFB-075D	0.375	0.156	◇ CP or CC

ⓘ = Imperial (in)

Ⓜ = Metric (mm)

Inserts sold separately

A **Tiny Mite Boring Heads**

002 and 152 Style | TMT Style | Bore Diameter Range: 0.050" - 1.625"

DRILLING

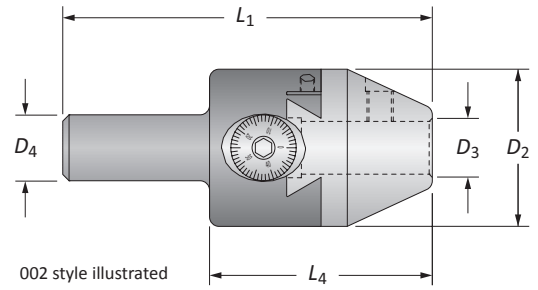

B

BORING

002 and 152 Style

Bore Diameter Range		Boring Head						Part No.
Center Hole	Outboard Hole	D_2	D_3	D_4	L_4	L_1	Offset	
0.050 - 1.625	-	1.50	0.500	0.500	2.125	3.500	0.562	MB002-500
0.050 - 1.625	-	1.50	0.500	0.625	2.125	3.500	0.562	MB002-625
0.050 - 1.625	-	1.50	0.500	0.750	2.125	3.500	0.562	MB002-750
0.050 - 1.625	1.000 - 2.500	1.50	0.375	0.500	2.125	3.500	0.562	MB152-500
0.050 - 1.625	1.000 - 2.500	1.50	0.375	0.625	2.125	3.500	0.562	MB152-625
0.050 - 1.625	1.000 - 2.500	1.50	0.375	0.750	2.125	3.500	0.562	MB152-750

Imperial (in) = 0.001" adjustment on diameter

C

REAMING

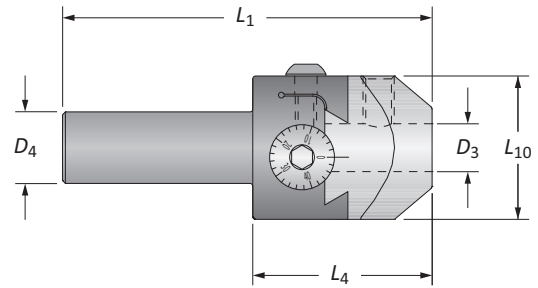

D

BURNISHING

TMT Style

Bore Diameter Range		Boring Head					Part No.
Center Hole	Outboard Hole	D_3	L_{10}	L_4	L_1	D_4	
0.050 - 0.580	-	0.250 ϕ	0.750	1.00	2.00	0.375	TMT-0750H
0.050 - 1.100	0.670 - 1.730	0.250 ϕ	1.000	1.00	2.00	0.500	TMT-1000H



Imperial (in) = 0.001" adjustment on diameter

F

THREADING

X

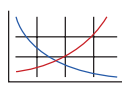
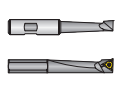
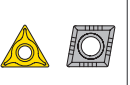
SPECIALS

B20: 80 - 81 
B20: 47 - 59 
B20: 60 - 67 
B20: 83 

key on B20: 1

i = Imperial (in)
m = Metric (mm)



Tiny Mite Boring Head Replacement Parts

002 and 152 Style | TMT Style

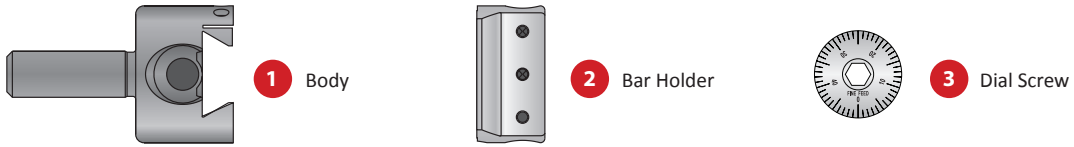

002 and 152 Style

	Head Part No.	Hardware Kit	Components		
			1	2	3
i	MB002-500	CB1500-HDW	MB002-500-BD	MB002-BH	DS-CB2
	MB002-625	CB1500-HDW	MB002-625-BD	MB002-BH	DS-CB2
	MB002-750	CB1500-HDW	MB002-750-BD	MB002-BH	DS-CB2
	MB152-500	CB1500-HDW	MB002-500-BD	MB152-BH	DS-CB2
	MB152-625	CB1500-HDW	MB002-625-BD	MB152-BH	DS-CB2
	MN152-750	CB1500-HDW	MB002-750-BD	MB152-BH	DS-CB2

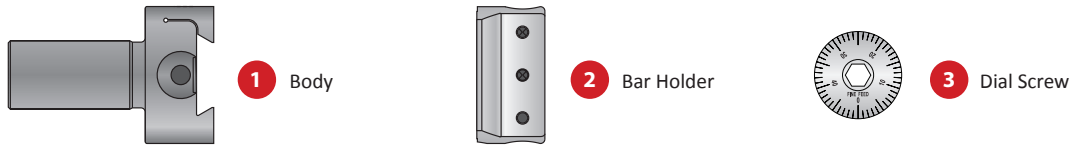

TMT Style

	Head Part No.	Hardware Kit	Components		
			1	2	3
i	TMT-0750H	TMT0750-HDW	TMT0750-BD	TMT0750H-BH	DS-MDB0750
	TMT-1000H	TMT0750-HDW	TMT1000-BD	TMT1000H-BH	DS-CT1250

i = Imperial (in)
m = Metric (mm)

Criterion Boring Head Adapters

Extensions | Reducers

Extensions

Dimensions				Part No.	Pin Spanner Wrench
D_1	L_1	Thread			
1.00	1.00	7/8-20		CB1000-IA1000	CB1000-PSW
1.00	2.00	7/8-20		CB1000-IA2000	CB1000-PSW
1.25	1.25	7/8-20		CB1250-IA1250	CB1250-PSW
1.25	2.50	7/8-20		CB1250-IA2500	CB1250-PSW
i 1.50	1.50	7/8-20		CB1500-IA1500	CB1500-PSW
i 1.50	3.00	7/8-20		CB1500-IA3000	CB1500-PSW
2.00	2.00	7/8-20		CB2000-IA2000	CB2000-PSW
2.00	4.00	7/8-20		CB2000-IA4000	CB2000-PSW
3.00	3.00	1-1/2-18		CB3000-IA3000	CB3000-PSW
3.00	6.00	1-1/2-18		CB3000-IA6000	CB3000-PSW

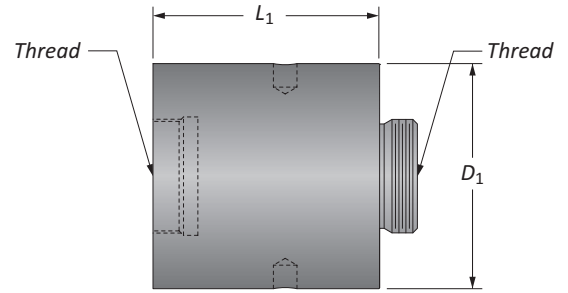

Reducers

Dimensions				Part No.	Pin Spanner Wrench
D_1	D_5	L_1	Thread		
1.50	1.00	1.00	7/8-20	CB1500-IRCB1000	CB1500-PSW
1.50	1.25	1.00	7/8-20	CB1500-IRCB1250	CB1500-PSW
2.00	1.00	1.00	7/8-20	CB2000-IRCB1000	CB2000-PSW
2.00	1.25	1.00	7/8-20	CB2000-IRCB1250	CB2000-PSW
i 2.00	1.50	1.00	7/8-20	CB2000-IRCB1500	CB2000-PSW
3.00	1.00	1.25	1-1/2-18	CB3000-IRCB1000	CB3000-PSW
3.00	1.25	1.25	1-1/2-18	CB3000-IRCB1250	CB3000-PSW
3.00	1.50	1.25	1-1/2-18	CB3000-IRCB1500	CB3000-PSW
3.00	2.00	1.25	1-1/2-18	CB3000-IRCB2000	CB3000-PSW

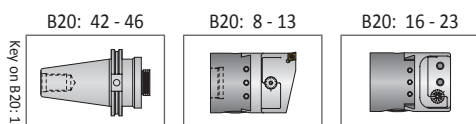
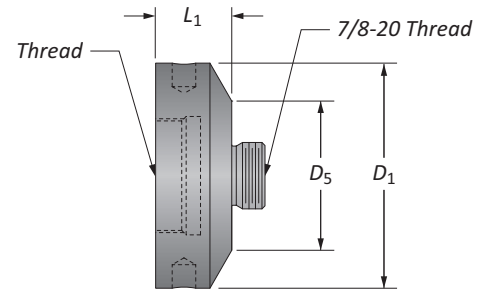

i = Imperial (in)
m = Metric (mm)



CB Style Boring Heads

Bar Holder Adapters

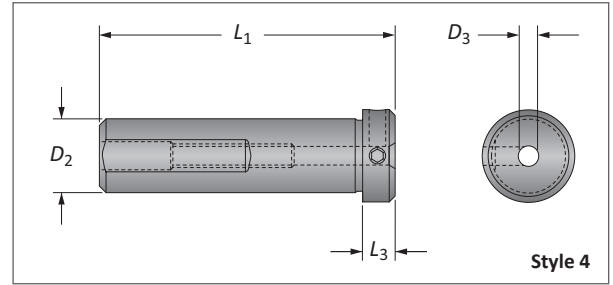
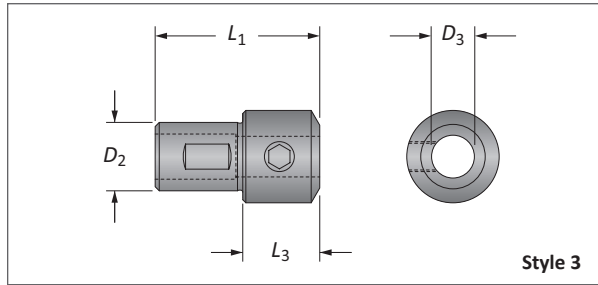
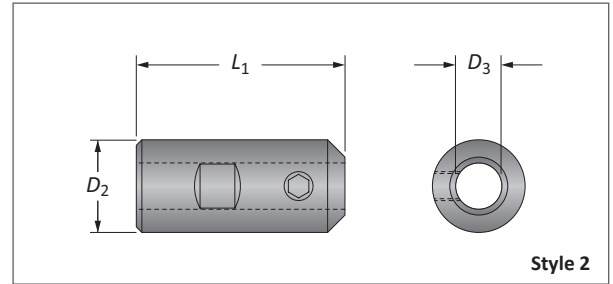
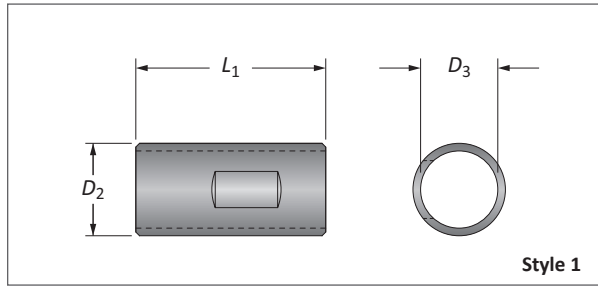

Adapter						
D_3	D_2	L_1	L_3	Style	Part No.	
0.125	0.250	0.695	0.200	3	BTH-01250250	
0.125	0.375	2.000	0.220	4	BTH-01250375	
0.125	0.500	2.000	0.220	4	BTH-01250500	
0.125	0.625	2.000	0.220	4	BTH-01250625	
0.125	0.750	2.000	0.220	4	BTH-01250750	
0.187	0.375	1.312	-	1	BTH-01870375	
0.187	0.500	1.312	-	1	BTH-01870500	
0.250	0.375	1.312	-	1	BTH-02500375	
0.250	0.500	1.312	-	1	BTH-02500500	
0.250	0.625	2.000	0.220	4	BTH-02500625	
0.250	0.750	2.000	0.220	4	BTH-02500750	
0.312	0.375	1.312	-	1	BTH-03120375	
0.312	0.500	1.312	-	1	BTH-03120500	
0.375	0.750	2.406	-	2	BTH-03750750	
0.375	1.000	2.250	-	2	BTH-03751000	
0.500	0.750	2.406	0.910	3	BTH-05000750	
0.500	1.000	2.250	-	2	BTH-05001000	
0.625	0.750	1.500	-	1	BTH-06250750	
0.625	1.000	2.406	1.120	3	BTH-06251000	
0.750	1.000	2.406	1.120	3	BTH-07501000	
1.000	1.500	3.000	1.000	3	BTH-10001500	
i						
10	12	32	-	1	BTH-10M12M	
10	20	65	24	3	BTH-10M20M	
10	25	65	-	2	BTH-10M25M	
12	20	65	24	3	BTH-12M20M	
12	25	65	-	2	BTH-12M25M	
20	25	70	28	3	BTH-20M25M	
m						

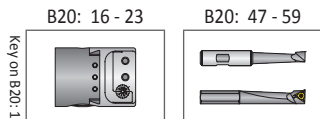

Key on B20: 1

i = Imperial (in)
m = Metric (mm)

CBER® Boring Heads

Standard Adjusting | Bore Diameter Range: 0.672" - 1.600"

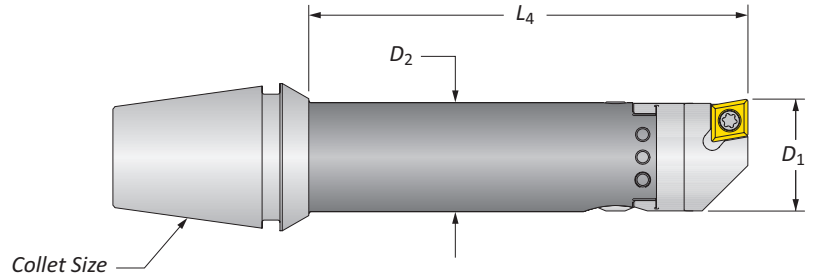

D ₁ Range	Boring Head			Part No.	Collet Nut	Collet Nut Wrench	Insert		
	D ₂	L ₄	Collet Size				IC	T ₁	Style
0.672 - 0.944	0.625	1.500	ER16	CBER16S-CP*	–	CBER16-NUTW	0.250	0.094	◇ CP or CC
0.672 - 0.944	0.625	2.500	ER16	CBER16-CP*	–	CBER16-NUTW	0.250	0.094	◇ CP or CC
0.672 - 0.944	0.625	1.500	ER16	CBER16S-TP*	–	CBER16-NUTW	0.250	0.094	△ TP
0.672 - 0.944	0.625	2.500	ER16	CBER16-TP*	–	CBER16-NUTW	0.250	0.094	△ TP
0.672 - 0.944	0.625	1.500	ER20	CBER20S-CP	CBER20-NUT	CBER20-NUTW	0.250	0.094	◇ CP or CC
0.672 - 0.944	0.625	2.500	ER20	CBER20-CP	CBER20-NUT	CBER20-NUTW	0.250	0.094	◇ CP or CC
0.672 - 0.944	0.625	1.500	ER20	CBER20S-TP	CBER20-NUT	CBER20-NUTW	0.250	0.094	△ TP
0.672 - 0.944	0.625	2.500	ER20	CBER20-TP	CBER20-NUT	CBER20-NUTW	0.250	0.094	△ TP
0.825 - 1.087	0.750	1.500	ER25	CBER25S-CP	CBER25-NUT	CBER25-NUTW	0.250	0.094	◇ CP or CC
0.825 - 1.087	0.750	3.000	ER25	CBER25-CP	CBER25-NUT	CBER25-NUTW	0.250	0.094	◇ CP or CC
0.825 - 1.087	0.750	1.500	ER25	CBER25S-TP	CBER25-NUT	CBER25-NUTW	0.250	0.094	△ TP
0.825 - 1.087	0.750	3.000	ER25	CBER25-TP	CBER25-NUT	CBER25-NUTW	0.250	0.094	△ TP
1.050 - 1.320	1.000	2.000	ER32	CBER32S-CP	CBER32-NUT	CBER32-NUTW	0.250	0.094	◇ CP or CC
1.050 - 1.320	1.000	4.000	ER32	CBER32-CP	CBER32-NUT	CBER32-NUTW	0.250	0.094	◇ CP or CC
1.050 - 1.320	1.000	2.000	ER32	CBER32S-TP	CBER32-NUT	CBER32-NUTW	0.250	0.094	△ TP
1.050 - 1.320	1.000	4.000	ER32	CBER32-TP	CBER32-NUT	CBER32-NUTW	0.250	0.094	△ TP
1.300 - 1.600	1.250	2.500	ER40	CBER40S-CP	CBER40-NUT	CBER40-NUTW	0.250	0.094	◇ CP or CC
1.300 - 1.600	1.250	5.000	ER40	CBER40-CP	CBER40-NUT	CBER40-NUTW	0.250	0.094	◇ CP or CC
1.300 - 1.600	1.250	2.500	ER40	CBER40S-TP	CBER40-NUT	CBER40-NUTW	0.250	0.094	△ TP
1.300 - 1.600	1.250	5.000	ER40	CBER40-TP	CBER40-NUT	CBER40-NUTW	0.250	0.094	△ TP
17.1 - 23.9	15.9	38.1	ER16	CBER16MS-CP*	–	CBER16-NUTW	6.35	2.38	◇ CP or CC
17.1 - 23.9	15.9	63.5	ER16	CBER16M-CP*	–	CBER16-NUTW	6.35	2.38	◇ CP or CC
17.1 - 23.9	15.9	38.1	ER16	CBER16MS-TP*	–	CBER16-NUTW	6.35	2.38	△ TP
17.1 - 23.9	15.9	63.5	ER16	CBER16M-TP*	–	CBER16-NUTW	6.35	2.38	△ TP
17.1 - 23.9	15.9	38.1	ER20	CBER20MS-CP	CBER20-NUT	CBER20-NUTW	6.35	2.38	◇ CP or CC
17.1 - 23.9	15.9	63.5	ER20	CBER20M-CP	CBER20-NUT	CBER20-NUTW	6.35	2.38	◇ CP or CC
17.1 - 23.9	15.9	38.1	ER20	CBER20MS-TP	CBER20-NUT	CBER20-NUTW	6.35	2.38	△ TP
17.1 - 23.9	15.9	63.5	ER20	CBER20M-TP	CBER20-NUT	CBER20-NUTW	6.35	2.38	△ TP
20.1 - 27.6	19.05	38.1	ER25	CBER25MS-CP	CBER25-NUT	CBER25-NUTW	6.35	2.38	◇ CP or CC
20.1 - 27.6	19.05	76.2	ER25	CBER25M-CP	CBER25-NUT	CBER25-NUTW	6.35	2.38	◇ CP or CC
20.1 - 27.6	19.05	38.1	ER25	CBER25MS-TP	CBER25-NUT	CBER25-NUTW	6.35	2.38	△ TP
20.1 - 27.6	19.05	76.2	ER25	CBER25M-TP	CBER25-NUT	CBER25-NUTW	6.35	2.38	△ TP
26.7 - 33.5	25.4	50.8	ER32	CBER32MS-CP	CBER32-NUT	CBER32-NUTW	6.35	2.38	◇ CP or CC
26.7 - 33.5	25.4	101.6	ER32	CBER32M-CP	CBER32-NUT	CBER32-NUTW	6.35	2.38	◇ CP or CC
26.7 - 33.5	25.4	50.8	ER32	CBER32MS-TP	CBER32-NUT	CBER32-NUTW	6.35	2.38	△ TP
26.7 - 33.5	25.4	101.6	ER32	CBER32M-TP	CBER32-NUT	CBER32-NUTW	6.35	2.38	△ TP
33.1 - 40.6	31.75	63.5	ER40	CBER40MS-CP	CBER40-NUT	CBER40-NUTW	6.35	2.38	◇ CP or CC
33.1 - 40.6	31.75	127	ER40	CBER40M-CP	CBER40-NUT	CBER40-NUTW	6.35	2.38	◇ CP or CC
33.1 - 40.6	31.75	63.5	ER40	CBER40MS-TP	CBER40-NUT	CBER40-NUTW	6.35	2.38	△ TP
33.1 - 40.6	31.75	127	ER40	CBER40M-TP	CBER40-NUT	CBER40-NUTW	6.35	2.38	△ TP

*NOTE: CBER16 style boring system includes the ER16 collet nut with M22x1.5 thread as part of the assembly
 Imperial (in) = 0.001" adjustment on diameter
 Metric (mm) = 0.02mm adjustment on diameter

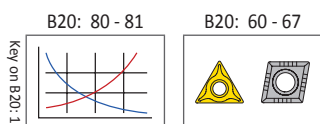

i = Imperial (in)
 m = Metric (mm)

Inserts sold separately

CBER® Replacement Parts

Standard Adjusting

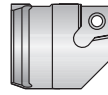
**1** Body**2** Insert Holder**3** Dial Screw

Head Part No.	Hardware Kit	Components			Torx Screw	Torx Wrench
		1	2	3		
CBER16S-CP	CB0625-HDW	CBER16S-BD	CB0625CP-IH	DS-MDB0625	TXS-116-1	8T-7
CBER16-CP	CB0625-HDW	CBER16BD	CB0625CP-IH	DS-MDB0625	TXS-116-1	8T-7
CBER16S-TP	CB0625-HDW	CBER16S-BD	CB0625TP-IH	DS-MDB0625	TXS-116-1	8T-7
CBER16-TP	CB0625-HDW	CBER16BD	CB0625TP-IH	DS-MDB0625	TXS-116-1	8T-7
CBER20S-CP	CB0625-HDW	CBER20S-BD	CB0625CP-IH	DS-MDB0625	TXS-116-1	8T-7
CBER20-CP	CB0625-HDW	CBER20BD	CB0625CP-IH	DS-MDB0625	TXS-116-1	8T-7
CBER20S-TP	CB0625-HDW	CBER20S-BD	CB0625TP-IH	DS-MDB0625	TXS-116-1	8T-7
CBER20-TP	CB0625-HDW	CBER20BD	CB0625TP-IH	DS-MDB0625	TXS-116-1	8T-7
CBER25S-CP	CB0750-HDW	CBER25S-BD	CB0750CP-IH	DS-MDB0750	TXS-116-1	8T-7
CBER25-CP	CB0750-HDW	CBER25BD	CB0750CP-IH	DS-MDB0750	TXS-116-1	8T-7
CBER25S-TP	CB0750-HDW	CBER25S-BD	CB0750TP-IH	DS-MDB0750	TXS-116-1	8T-7
CBER25-TP	CB0750-HDW	CBER25BD	CB0750TP-IH	DS-MDB0750	TXS-116-1	8T-7
CBER32S-CP	CB1000-HDW	CBER32S-BD	CB1000CP-IH	DS-MDB1000	TXS-116-1	8T-7
CBER32-CP	CB1000-HDW	CBER32BD	CB1000CP-IH	DS-MDB1000	TXS-116-1	8T-7
CBER32S-TP	CB1000-HDW	CBER32S-BD	CB1000TP-IH	DS-MDB1000	TXS-116-1	8T-7
CBER32-TP	CB1000-HDW	CBER32BD	CB1000TP-IH	DS-MDB1000	TXS-116-1	8T-7
CBER40S-CP	CB1250-HDW	CBER40S-BD	CB1250CP-IH	DS-MDB1000	TXS-116-1	8T-7
CBER40-CP	CB1250-HDW	CBER40BD	CB1250CP-IH	DS-MDB1000	TXS-116-1	8T-7
CBER40S-TP	CB1250-HDW	CBER40S-BD	CB1250TP-IH	DS-MDB1000	TXS-116-1	8T-7
CBER40-TP	CB1250-HDW	CBER40BD	CB1250TP-IH	DS-MDB1000	TXS-116-1	8T-7
CBER16MS-CP	CB0625-HDW	CBER16MS-BD	CB016MCP-IH	DS-MDB16M	TXS-116-1	8T-7
CBER16M-CP	CB0625-HDW	CBER16M-BD	CB016MCP-IH	DS-MDB16M	TXS-116-1	8T-7
CBER16MS-TP	CB0625-HDW	CBER16MS-BD	CB016MTP-IH	DS-MDB16M	TXS-116-1	8T-7
CBER16M-TP	CB0625-HDW	CBER16M-BD	CB016MTP-IH	DS-MDB16M	TXS-116-1	8T-7
CBER20MS-CP	CB0625-HDW	CBER20MS-BD	CB016MCP-IH	DS-MDB16M	TXS-116-1	8T-7
CBER20M-CP	CB0625-HDW	CBER20M-BD	CB016MCP-IH	DS-MDB16M	TXS-116-1	8T-7
CBER20MS-TP	CB0625-HDW	CBER20MS-BD	CB016MTP-IH	DS-MDB16M	TXS-116-1	8T-7
CBER20M-TP	CB0625-HDW	CBER20M-BD	CB016MTP-IH	DS-MDB16M	TXS-116-1	8T-7
CBER25MS-CP	CB0750-HDW	CBER25MS-BD	CB020MCP-IH	DS-MDB20M	TXS-116-1	8T-7
CBER25M-CP	CB0750-HDW	CBER25M-BD	CB020MCP-IH	DS-MDB20M	TXS-116-1	8T-7
CBER25MS-TP	CB0750-HDW	CBER25MS-BD	CB020MTP-IH	DS-MDB20M	TXS-116-1	8T-7
CBER25M-TP	CB0750-HDW	CBER25M-BD	CB020MTP-IH	DS-MDB20M	TXS-116-1	8T-7
CBER32MS-CP	CB1000-HDW	CBER32MS-BD	CB025MCP-IH	DS-MDB25M	TXS-116-1	8T-7
CBER32M-CP	CB1000-HDW	CBER32M-BD	CB025MCP-IH	DS-MDB25M	TXS-116-1	8T-7
CBER32MS-TP	CB1000-HDW	CBER32MS-BD	CB025MTP-IH	DS-MDB25M	TXS-116-1	8T-7
CBER32M-TP	CB1000-HDW	CBER32M-BD	CB025MTP-IH	DS-MDB25M	TXS-116-1	8T-7
CBER40MS-CP	CB1250-HDW	CBER40MS-BD	CB032MCP-IH	DS-MDB25M	TXS-116-1	8T-7
CBER40M-CP	CB1250-HDW	CBER40M-BD	CB032MCP-IH	DS-MDB25M	TXS-116-1	8T-7
CBER40MS-TP	CB1250-HDW	CBER40MS-BD	CB032MTP-IH	DS-MDB25M	TXS-116-1	8T-7
CBER40M-TP	CB1250-HDW	CBER40M-BD	CB032MTP-IH	DS-MDB25M	TXS-116-1	8T-7

i = Imperial (in)

m = Metric (mm)

Screws sold in multiples of 10

CBER® Boring Heads

Micro Adjusting | SGL Style

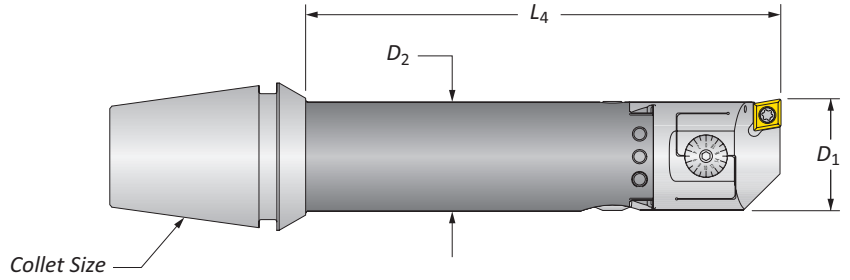

Micro Adjusting

D ₁ Range	Boring Head			Part No.	Collet Nut	Collet Nut Wrench	Insert			
	D ₂	L ₄	Collet Size				IC	T ₁	Style	
i	1.050 - 1.320	1.000	2.700	ER32	CBER32S-CPMA	CBER32-NUT	CBER32-NUTW	0.250	0.094	◇ CP or CC
	1.050 - 1.320	1.000	4.700	ER32	CBER32-CPMA	CBER32-NUT	CBER32-NUTW	0.250	0.094	◇ CP or CC
	1.050 - 1.320	1.000	2.700	ER32	CBER32S-TPMA	CBER32-NUT	CBER32-NUTW	0.250	0.094	▲ TP
	1.050 - 1.320	1.000	4.700	ER32	CBER32-TPMA	CBER32-NUT	CBER32-NUTW	0.250	0.094	▲ TP
	1.300 - 1.600	1.250	3.200	ER40	CBER40S-CPMA	CBER40-NUT	CBER40-NUTW	0.250	0.094	◇ CP or CC
	1.300 - 1.600	1.250	5.700	ER40	CBER40-CPMA	CBER40-NUT	CBER40-NUTW	0.250	0.094	◇ CP or CC
	1.300 - 1.600	1.250	3.200	ER40	CBER40S-TPMA	CBER40-NUT	CBER40-NUTW	0.250	0.094	▲ TP
	1.300 - 1.600	1.250	5.700	ER40	CBER40-TPMA	CBER40-NUT	CBER40-NUTW	0.250	0.094	▲ TP
m	26.7 - 33.5	25.4	68.5	ER32	CBER32MS-CPMA	CBER32-NUT	CBER32-NUTW	6.35	2.38	◇ CP or CC
	26.7 - 33.5	25.4	119.4	ER32	CBER32M-CPMA	CBER32-NUT	CBER32-NUTW	6.35	2.38	◇ CP or CC
	26.7 - 33.5	25.4	68.5	ER32	CBER32MS-TPMA	CBER32-NUT	CBER32-NUTW	6.35	2.38	▲ TP
	26.7 - 33.5	25.4	119.4	ER32	CBER32M-TPMA	CBER32-NUT	CBER32-NUTW	6.35	2.38	▲ TP
	33.1 - 40.6	31.75	81.2	ER40	CBER40MS-CPMA	CBER40-NUT	CBER40-NUTW	6.35	2.38	◇ CP or CC
	33.1 - 40.6	31.75	144.7	ER40	CBER40M-CPMA	CBER40-NUT	CBER40-NUTW	6.35	2.38	◇ CP or CC
	33.1 - 40.6	31.75	81.2	ER40	CBER40MS-TPMA	CBER40-NUT	CBER40-NUTW	6.35	2.38	▲ TP
	33.1 - 40.6	31.75	144.7	ER40	CBER40M-TPMA	CBER40-NUT	CBER40-NUTW	6.35	2.38	▲ TP

Imperial (in) = 0.00005" adjustment on diameter
Metric (mm) = 0.001mm adjustment on diameter

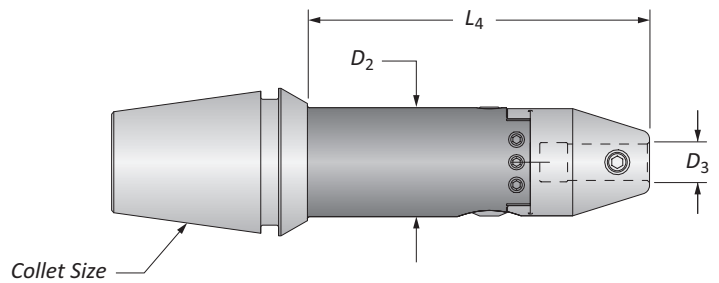

SGL Style

D ₁ Range	Boring Head			Collet Size	Part No.	Collet Nut	Collet Nut Wrench
	D ₃	D ₂	L ₄				
0.050 - 0.380	0.125	0.625	1.500	ER16	CBER16S-SG*	-	CBER16-NUTW
0.050 - 0.380	0.125	0.625	2.500	ER16	CBER16-SG*	-	CBER16-NUTW
0.050 - 0.380	0.125	0.625	1.500	ER20	CBER20S-SG	CBER20-NUT	CBER20-NUTW
0.050 - 0.380	0.125	0.625	2.500	ER20	CBER20-SG	CBER20-NUT	CBER20-NUTW
i	0.050 - 0.470	0.250	0.750	ER25	CBER25S-SH	CBER25-NUT	CBER25-NUTW
	0.050 - 0.470	0.250	3.187	ER25	CBER25-SH	CBER25-NUT	CBER25-NUTW
	0.120 - 0.645	0.375	1.000	ER32	CBER32S-SA	CBER32-NUT	CBER32-NUTW
	0.120 - 0.645	0.375	4.437	ER32	CBER32-SA	CBER32-NUT	CBER32-NUTW
	0.250 - 0.800	0.500	1.250	ER40	CBER40S-SB	CBER40-NUT	CBER40-NUTW
	0.250 - 0.800	0.500	5.281	ER40	CBER40-SB	CBER40-NUT	CBER40-NUTW

*NOTE: CBER16 style boring system includes the ER16 collet nut with M22x1.5 thread as part of the assembly
Imperial (in) = 0.001" adjustment on diameter

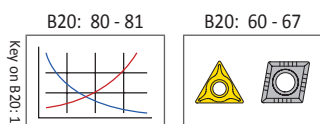

i = Imperial (in)
m = Metric (mm)

Inserts sold separately

CBER® Replacement Parts

Micro Adjusting | SGL Style

**Micro Adjusting**

	Head Part No.	Hardware Kit	Components						
			1	2	3	4			
i	CBER32S-CPMA	CB1000-HDW	CBER32S-BD	CB1000CPMA-IH	DS-MDB1000	DS-MA1500	MAW-1000	TXS-116-1	8T-7
	CBER32-CPMA	CB1000-HDW	CBER32BD	CB1000CPMA-IH	DS-MDB1000	DS-MA1500	MAW-1000	TXS-116-1	8T-7
	CBER32S-TPMA	CB1000-HDW	CBER32S-BD	CB1000TPMA-IH	DS-MDB1000	DS-MA1500	MAW-1000	TXS-116-1	8T-7
	CBER32-TPMA	CB1000-HDW	CBER32BD	CB1000TPMA-IH	DS-MDB1000	DS-MA1500	MAW-1000	TXS-116-1	8T-7
	CBER40S-CPMA	CB1250-HDW	CBER40S-BD	CB1250CPMA-IH	DS-MDB1000	DS-MA1500	MAW-1000	TXS-116-1	8T-7
	CBER40-CPMA	CB1250-HDW	CBER40S-BD	CB1250CPMA-IH	DS-MDB1000	DS-MA1500	MAW-1000	TXS-116-1	8T-7
	CBER40S-TPMA	CB1250-HDW	CBER40S-BD	CB1250TPMA-IH	DS-MDB1000	DS-MA1500	MAW-1000	TXS-116-1	8T-7
	CBER40-TPMA	CB1250-HDW	CBER40BD	CB1250TPMA-IH	DS-MDB1000	DS-MA1500	MAW-1000	TXS-116-1	8T-7
m	CBER32MS-CPMA	CB1000-HDW	CBER32MS-BD	CB025MCPMA-IH	DS-MDB25M	DS-MA1500	MAW-1000	TXS-116-1	8T-7
	CBER32M-CPMA	CB1000-HDW	CBER32M-BD	CB025MCPMA-IH	DS-MDB25M	DS-MA1500	MAW-1000	TXS-116-1	8T-7
	CBER32MS-TPMA	CB1000-HDW	CBER32MS-BD	CB025MTPMA-IH	DS-MDB25M	DS-MA1500	MAW-1000	TXS-116-1	8T-7
	CBER32M-TPMA	CB1000-HDW	CBER32M-BD	CB025MTPMA-IH	DS-MDB25M	DS-MA1500	MAW-1000	TXS-116-1	8T-7
	CBER40MS-CPMA	CB1250-HDW	CBER40MS-BD	CB032MCPMA-IH	DS-MDB25M	DS-MA1500	MAW-1000	TXS-116-1	8T-7
	CBER40M-CPMA	CB1250-HDW	CBER40M-BD	CB032MCPMA-IH	DS-MDB25M	DS-MA1500	MAW-1000	TXS-116-1	8T-7
	CBER40MS-TPMA	CB1250-HDW	CBER40MS-BD	CB032MTPMA-IH	DS-MDB25M	DS-MA1500	MAW-1000	TXS-116-1	8T-7
	CBER40M-TPMA	CB1250-HDW	CBER40M-BD	CB032MTPMA-IH	DS-MDB25M	DS-MA1500	MAW-1000	TXS-116-1	8T-7

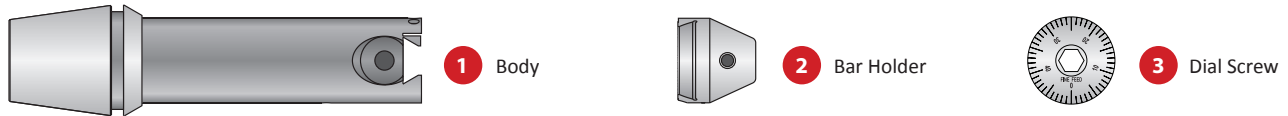
**SGL Style**

	Head Part No.	Hardware Kit	Components		
			1	2	3
i	CBER16S-SG	CB0625-HDW	CBER16S-BD	SGL0625G-BH	DS-MDB0625
	CBER16-SG	CB0625-HDW	CBER16BD	SGL0625G-BH	DS-MDB0625
	CBER20S-SG	CB0625-HDW	CBER20S-BD	SGL0625G-BH	DS-MDB0625
	CBER20-SG	CB0625-HDW	CBER20BD	SGL0625G-BH	DS-MDB0625
	CBER25S-SH	CB0750-HDW	CBER25S-BD	SGL0750H-BH	DS-MDB0750
	CBER25-SH	CB0750-HDW	CBER25BD	SGL0750H-BH	DS-MDB0750
	CBER32S-SA	CB1000-HDW	CBER32S-BD	SGL1000A-BH	DS-MDB1000
	CBER32-SA	CB1000-HDW	CBER32BD	SGL1000A-BH	DS-MDB1000
	CBER40S-SB	CB1250-HDW	CBER40S-BD	SGL1250B-BH	DS-MDB1000
	CBER40-SB	CB1250-HDW	CBER40BD	SGL1250B-BH	DS-MDB1000

i = Imperial (in)

m = Metric (mm)

Screws sold in multiples of 10

Cri-Tip Boring Heads - Komet® ABS® Connection

Standard Adjusting | Bore Diameter Range: 1.585" - 5.065" (38mm - 76mm)

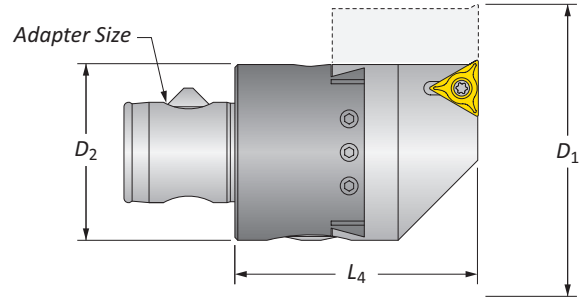

D ₁ Range	Boring Head			Part No.	IC	Insert		
	D ₂	L ₄	Adapter Size			T ₁	Style	
i	1.585 - 2.700	1.500	2.550	A40	CTP1500-A40TP	0.375	0.125	▲ TP
	1.585 - 2.700	1.500	2.550	A40	CTP1500-A40CP	0.375	0.156	◆ CP or CC
	1.585 - 2.700	1.500	2.800*	A50	CTP1500-A50TP	0.375	0.125	▲ TP
	1.585 - 2.700	1.500	2.800*	A50	CTP1500-A50CP	0.375	0.156	◆ CP or CC
	2.060 - 3.320	2.000	2.925	A50	CTP2000-A50TP	0.375	0.125	▲ TP
	2.060 - 3.320	2.000	2.925	A50	CTP2000-A50CP	0.375	0.156	◆ CP or CC
	3.065 - 5.065	3.000	4.250	A80	CTP3000-A80TP	0.375	0.125	▲ TP
	3.065 - 5.065	3.000	4.250	A80	CTP3000-A80CP	0.375	0.156	◆ CP or CC
m	41.00 - 68.00	38.00	64.00	A40	CTP038M-A40TP	9.53	3.18	▲ TP
	41.00 - 68.00	38.00	64.00	A40	CTP038M-A40CP	9.53	3.96	◆ CP or CC
	41.00 - 68.00	38.00	71.00*	A50	CTP038M-A50TP	9.53	3.18	▲ TP
	41.00 - 68.00	38.00	71.00*	A50	CTP038M-A50CP	9.53	3.96	◆ CP or CC
	53.00 - 84.00	50.00	74.00	A50	CTP050M-A50TP	9.53	3.18	▲ TP
	53.00 - 84.00	50.00	74.00	A50	CTP050M-A50CP	9.53	3.96	◆ CP or CC
	78.00 - 128.00	76.00	100.00	A80	CTP076M-A80TP	9.53	3.18	▲ TP
	78.00 - 128.00	76.00	100.00	A80	CTP076M-A80CP	9.53	3.96	◆ CP or CC

*Max bore depth is 2.087" (53mm)
 Imperial (in) = 0.001" adjustment on diameter
 Metric (mm) = 0.02mm adjustment on diameter

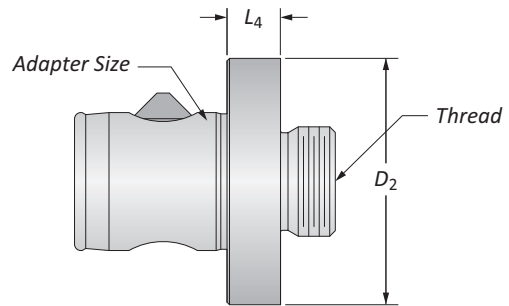

Shanks

D ₂	Shank			Adapter Size	Part No.
	L ₄	Thread	Adapter Size		
i	1.500	0.430	7/8-20	A40	CTP1500-A400875
	2.000	0.430	7/8-20	A50	CTP2000-A500875
	3.000	1.050	1-1/2-18	A80	CTP3000-A801500

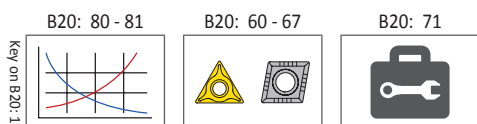

i = Imperial (in)
 m = Metric (mm)
 Inserts sold separately

A DRILLING
 B BORING
 C REAMING
 D BURNISHING
 E THREADING
 X SPECIALS



Cri-Tip Boring Heads - Komet® ABS® Connection

Micro Adjusting | Bore Diameter Range: 1.585" - 5.065" (38mm - 76mm)

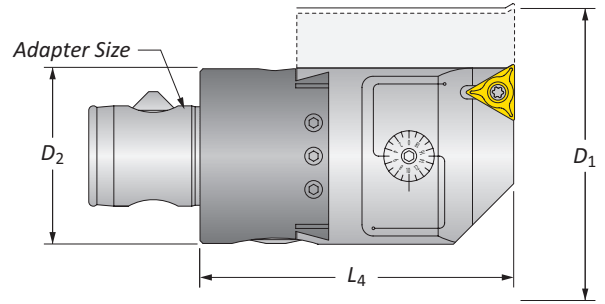

	Boring Head				Part No.	IC	T ₁	Style
	D ₁ Range	D ₂	L ₄	Adapter Size				
i	1.585 - 2.700	1.500	3.250	A40	CTP1500-A40TPMA	0.375	0.125	▲ TP
	1.585 - 2.700	1.500	3.250	A40	CTP1500-A40CPMA	0.375	0.156	◆ CP or CC
	1.585 - 2.700	1.500	3.500*	A50	CTP1500-A50TPMA	0.375	0.125	▲ TP
	1.585 - 2.700	1.500	3.500*	A50	CTP1500-A50CPMA	0.375	0.156	◆ CP or CC
	2.060 - 3.320	2.000	3.750	A50	CTP2000-A50TPMA	0.375	0.125	▲ TP
	2.060 - 3.320	2.000	3.750	A50	CTP2000-A50CPMA	0.375	0.156	◆ CP or CC
	3.065 - 5.065	3.000	4.875	A80	CTP3000-A80TPMA	0.375	0.125	▲ TP
	3.065 - 5.065	3.000	4.875	A80	CTP3000-A80CPMA	0.375	0.156	◆ CP or CC
m	41.00 - 68.00	38.00	82.00	A40	CTP038M-A40TPMA	9.53	3.18	▲ TP
	41.00 - 68.00	38.00	82.00	A40	CTP038M-A40CPMA	9.53	3.96	◆ CP or CC
	41.00 - 68.00	38.00	88.00*	A50	CTP038M-A50TPMA	9.53	3.18	▲ TP
	41.00 - 68.00	38.00	88.00*	A50	CTP038M-A50CPMA	9.53	3.96	◆ CP or CC
	53.00 - 84.00	50.00	95.00	A50	CTP050M-A50TPMA	9.53	3.18	▲ TP
	53.00 - 84.00	50.00	95.00	A50	CTP050M-A50CPMA	9.53	3.96	◆ CP or CC
	78.00 - 128.00	76.00	123.00	A80	CTP076M-A80TPMA	9.53	3.18	▲ TP
	78.00 - 128.00	76.00	123.00	A80	CTP076M-A80CPMA	9.53	3.96	◆ CP or CC

*Max bore depth is 2.087" (53mm)
 Imperial (in) = 0.00005" adjustment on diameter
 Metric (mm) = 0.001mm adjustment on diameter

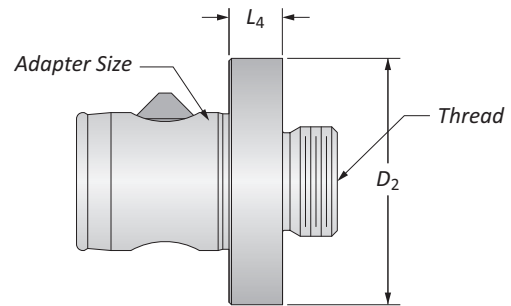

Shanks

	Shank				Part No.
	D ₂	L ₄	Thread	Adapter Size	
i	1.500	0.430	7/8-20	A40	CTP1500-A400875
	2.000	0.430	7/8-20	A50	CTP2000-A500875
	3.000	1.050	1-1/2-18	A80	CTP3000-A801500

B20: 80 - 81

B20: 60 - 67

B20: 71

i = Imperial (in)
 m = Metric (mm)
 Inserts sold separately

Cri-Tip Boring Heads - Big® Kaiser® Connection

Standard Adjusting | Bore Diameter Range: 1.585" - 5.065" (41mm - 128mm)

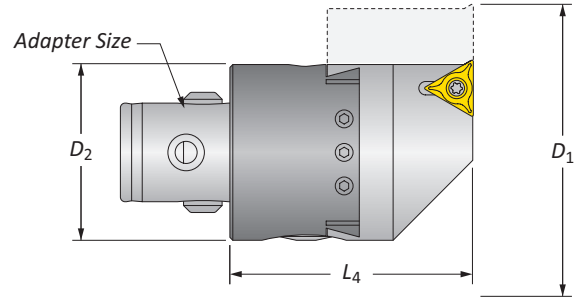

	Boring Heads				Insert			
	D_1 Range	D_4	L_4	Adapter Size	Part No.	IC	T_1	Style
i	1.585 - 2.700	1.500	2.305	KA4	CTP1500-K4TP	0.375	0.125	▲ TP
	1.585 - 2.700	1.500	2.305	KA4	CTP1500-K4CP	0.375	0.156	◆ CP or CC
	1.585 - 2.700	1.500	2.550*	KA5	CTP1500-K5TP	0.375	0.125	▲ TP
	1.585 - 2.700	1.500	2.550*	KA5	CTP1500-K5CP	0.375	0.156	◆ CP or CC
	2.060 - 3.320	2.000	2.740	KA5	CTP2000-K5TP	0.375	0.125	▲ TP
	2.060 - 3.320	2.000	2.740	KA5	CTP2000-K5CP	0.375	0.156	◆ CP or CC
	3.065 - 5.065	3.000	3.940	KA7	CTP3000-K7TP	0.375	0.125	▲ TP
	3.065 - 5.065	3.000	3.940	KA7	CTP3000-K7CP	0.375	0.156	◆ CP or CC
m	41.00 - 68.00	38.00	58.00	KA4	CTP038M-K4TP	9.53	3.18	▲ TP
	41.00 - 68.00	38.00	58.00	KA4	CTP038M-K4CP	9.53	3.96	◆ CP or CC
	41.00 - 68.00	38.00	64.00*	KA5	CTP038M-K5TP	9.53	3.18	▲ TP
	41.00 - 68.00	38.00	64.00*	KA5	CTP038M-K5CP	9.53	3.96	◆ CP or CC
	53.00 - 84.00	50.00	69.00	KA5	CTP050M-K5TP	9.53	3.18	▲ TP
	53.00 - 84.00	50.00	69.00	KA5	CTP050M-K5CP	9.53	3.96	◆ CP or CC
	78.00 - 128.00	76.00	100.00	KA7	CTP076M-K7TP	9.53	3.18	▲ TP
	78.00 - 128.00	76.00	100.00	KA7	CTP076M-K7CP	9.53	3.96	◆ CP or CC

*Max bore depth is 2.087" (53mm)
 Imperial (in) = 0.001" adjustment on diameter
 Metric (mm) = 0.02mm adjustment on diameter

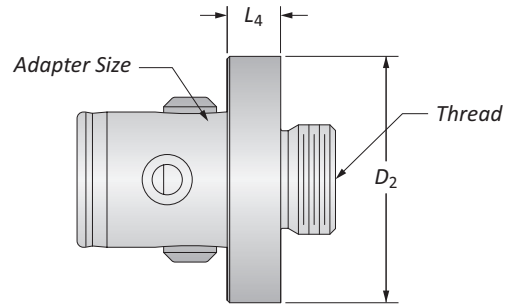

Shanks

	Shank				
	D_2	L_4	Thread	Adapter Size	Part No.
i	1.500	0.500	7/8-20	KA4	CTP1500-K408752
	2.000	0.500	7/8-20	KA5	CTP2000-K508752
	3.000	0.750	1-1/2-18	KA7	CTP3000-K715001

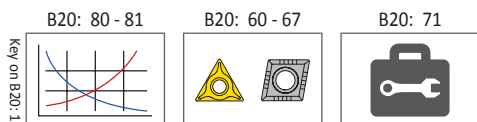

i = Imperial (in)
 m = Metric (mm)
 Inserts sold separately

A DRILLING
 B BORING
 C REAMING
 D BURNISHING
 E THREADING
 X SPECIALS



Cri-Tip Boring Heads - Big® Kaiser® Connection

Micro Adjusting | Bore Diameter Range: 1.585" - 5.065" (41mm - 128mm)

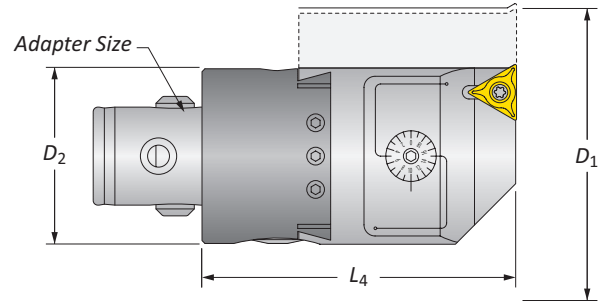

	Boring Head				Part No.	Insert		
	D ₁ Range	D ₄	L ₄	Adapter Size		IC	T ₁	Style
i	1.585 - 2.700	1.500	3.000	KA4	CTP1500-K4TPMA	0.375	0.125	▲ TP
	1.585 - 2.700	1.500	3.000	KA4	CTP1500-K4CPMA	0.375	0.156	◆ CP or CC
	1.585 - 2.700	1.500	3.250*	KA5	CTP1500-K5TPMA	0.375	0.125	▲ TP
	1.585 - 2.700	1.500	3.250*	KA5	CTP1500-K5CPMA	0.375	0.156	◆ CP or CC
	2.060 - 3.320	2.000	3.560	KA5	CTP2000-K5TPMA	0.375	0.125	▲ TP
	2.060 - 3.320	2.000	3.560	KA5	CTP2000-K5CPMA	0.375	0.156	◆ CP or CC
	3.065 - 5.065	3.000	4.560	KA7	CTP3000-K7TPMA	0.375	0.125	▲ TP
3.065 - 5.065	3.000	4.560	KA7	CTP3000-K7CPMA	0.375	0.156	◆ CP or CC	
m	41.00 - 68.00	38.00	76.00	KA4	CTP038M-K4TPMA	9.53	3.18	▲ TP
	41.00 - 68.00	38.00	76.00	KA4	CTP038M-K4CPMA	9.53	3.96	◆ CP or CC
	41.00 - 68.00	38.00	82.00*	KA5	CTP038M-K5TPMA	9.53	3.18	▲ TP
	41.00 - 68.00	38.00	82.00*	KA5	CTP038M-K5CPMA	9.53	3.96	◆ CP or CC
	53.00 - 84.00	50.00	90.00	KA5	CTP050M-K5TPMA	9.53	3.18	▲ TP
	53.00 - 84.00	50.00	90.00	KA5	CTP050M-K5CPMA	9.53	3.96	◆ CP or CC
	78.00 - 128.00	76.00	115.00	KA7	CTP076M-K7TPMA	9.53	3.18	▲ TP
	78.00 - 128.00	76.00	115.00	KA7	CTP076M-K7CPMA	9.53	3.96	◆ CP or CC

*Max bore depth is 2.087" (53mm)
 Imperial (in) = 0.00005" adjustment on diameter
 Metric (mm) = 0.001mm adjustment on diameter

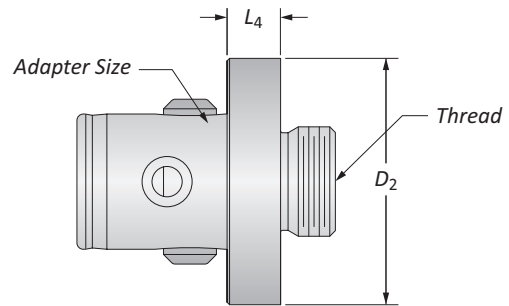

Shanks

	Shank				Part No.
	D ₂	L ₄	Thread	Adapter Size	
i	1.500	0.500	7/8-20	KA4	CTP1500-K408752
	2.000	0.500	7/8-20	KA5	CTP2000-K508752
	3.000	0.750	1-1/2-18	KA7	CTP3000-K715001

B20: 80 - 81

B20: 60 - 67

B20: 71

i = Imperial (in)
 m = Metric (mm)
 Inserts sold separately

Cri-Tip Boring Heads - Komet® ABS® Connection

CB Style Standard Adjusting | Bore Diameter Range: 0.050" - 11.000" (3mm - 279mm)

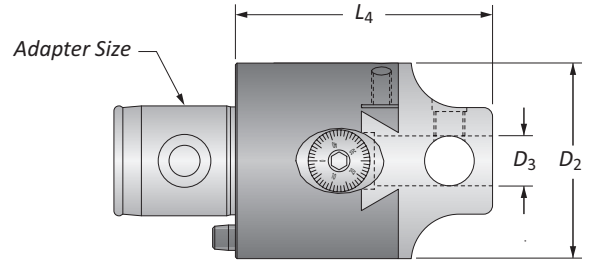

	Bore Diameter			Boring Head				Part No.	
	Center Hole	Outboard Hole	Cross Hole*	D ₃	D ₂	L ₄	Offset		Adapter Size
	0.050 - 1.625	-	-	0.500	1.500	2.530	0.562	A40	CTP1500-A40002
	0.050 - 1.625	1.000 - 2.500	-	0.375	1.500	2.530	0.562	A40	CTP1500-A40152
	0.050 - 1.625	-	-	0.500	1.500	2.780	0.562	A50	CTP1500-A50002
	0.050 - 1.625	1.000 - 2.500	-	0.375	1.500	2.780	0.562	A50	CTP1500-A50152
i	0.050 - 1.750	1.312 - 3.000	2.875 - 6.687	0.375	2.000	2.600	0.625	A50	CTP2000-A50202A
	0.050 - 1.750	1.312 - 3.000	2.875 - 6.687	0.500	2.000	2.600	0.625	A50	CTP2000-A50202B
	0.050 - 3.250	2.375 - 5.125	4.937 - 11.000	0.750	3.000	3.945	1.000	A80	CTP3000-A80203D
	0.050 - 3.250	2.375 - 5.125	-	0.750	3.000	4.165	1.000	A80	CTP3000-A8030MA**
	3.00 - 40.00	-	-	12.00	38.00	64.00	14	A40	CTP038M-A40B
	3.00 - 40.00	-	-	12.00	38.00	71.00	14	A50	CTP038M-A50B
m	3.00 - 44.00	35.00 - 76.00	73.00 - 169.00	12.00	50.00	66.00	16	A50	CTP050M-A50B
	10.00 - 70.00	60.00 - 130.00	126.00 - 279.00	20.00	76.00	100.00	25	A80	CTP076M-A80B
	10.00 - 70.00	60.00 - 130.00	-	20.00	76.00	106.00	25	A80	CTP076M-A80DMA**

***NOTICE:** Cross hole bars should always be secured in the bar holder with at least two set screws
 Imperial (in) = 0.001" adjustment on diameter | **Micro = 0.00005" adjustment on diameter
 Metric (mm) = 0.02mm adjustment on diameter | **Micro = 0.001mm adjustment on diameter

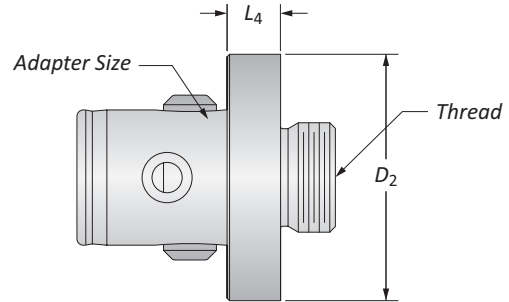

Shanks

	Shank				Part No.
	D ₂	L ₄	Thread	Adapter Size	
i	1.500	0.430	7/8-20	A40	CTP1500-A400875
	2.000	0.430	7/8-20	A50	CTP2000-A500875
	3.000	1.050	1-1/2-18	A80	CTP3000-A801500

B20: 80 - 81 | B20: 47 - 59 | B20: 60 - 67 | B20: 71

i = Imperial (in)
m = Metric (mm)



Cri-Tip Boring Heads - Big® Kaiser® Connection

CB Style Standard Adjusting | Bore Diameter Range: 0.050" - 11.000" (3mm - 279mm)

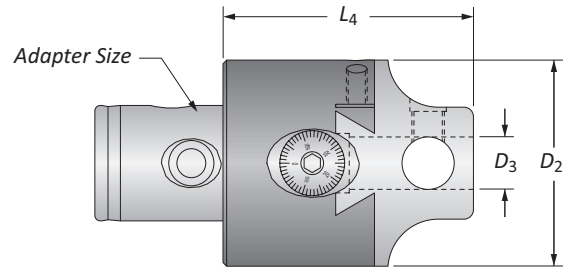

	Bore Diameter			Boring Head				Part No.	
	Center Hole	Outboard Hole	Cross Hole*	D ₃	D ₂	L ₄	Offset		Adapter Size
i	0.050 - 1.625	-	-	0.500	1.500	2.280	0.562	KA4	CTP1500-K4002
	0.050 - 1.625	1.000 - 2.500	-	0.375	1.500	2.280	0.562	KA4	CTP1500-K4152
	0.050 - 1.625	-	-	0.500	1.500	2.530	0.562	KA5	CTP1500-K5002
	0.050 - 1.625	1.000 - 2.500	-	0.375	1.500	2.530	0.562	KA5	CTP1500-K5152
	0.050 - 1.750	1.312 - 3.000	2.875 - 6.687	0.375	2.000	2.405	0.625	KA5	CTP2000-K5202A
	0.050 - 1.750	1.312 - 3.000	2.875 - 6.687	0.500	2.000	2.405	0.625	KA5	CTP2000-K5202B
	0.050 - 3.250	2.375 - 5.125	4.937 - 11.000	0.750	3.000	3.625	1.000	KA7	CTP3000-K7203D
	0.050 - 3.250	2.375 - 5.125	-	0.750	3.000	3.855	1.000	KA7	CTP3000-K7300MA**
m	3.00 - 40.00	-	-	12.00	38.00	58.00	14	KA4	CTP038M-K4B
	3.00 - 40.00	-	-	12.00	38.00	64.00	14	KA5	CTP038M-K5B
	3.00 - 44.00	35.00 - 76.00	73.00 - 169.00	12.00	50.00	61.00	16	KA5	CTP050M-K5B
	10.00 - 70.00	60.00 - 130.00	126.00 - 279.00	20.00	76.00	92.00	25	KA7	CTP076M-K7D
	10.00 - 70.00	60.00 - 130.00	-	20.00	76.00	98.00	25	KA7	CTP076M-K7DMA**

***NOTICE:** Cross hole bars should always be secured in the bar holder with at least two set screws
 Imperial (in) = 0.001" adjustment on diameter | **Micro = 0.00005" adjustment on diameter
 Metric (mm) = 0.02mm adjustment on diameter | **Micro = 0.001mm adjustment on diameter

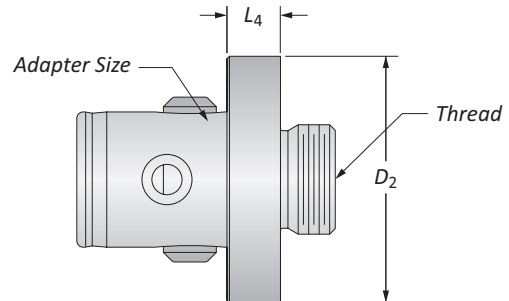

Shanks

	Shank				Part No.
	D ₂	L ₄	Thread	Adapter Size	
i	1.500	0.500	7/8-20	KA4	CTP1500-K408752
	2.000	0.500	7/8-20	KA5	CTP2000-K508752
	3.000	0.750	1-1/2-18	KA7	CTP3000-K715001

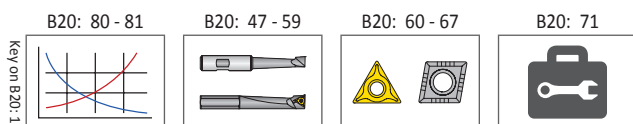

i = Imperial (in)
 m = Metric (mm)

Cri-Bar Adjustable Boring Bars

Round Shank | Bore Diameter Range: 0.050" - 1.600"

A
DRILLING

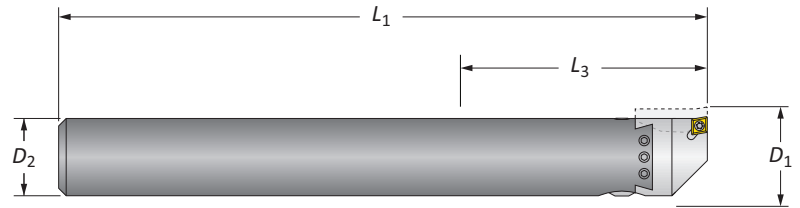

Standard Adjusting

D ₁ Range	Boring Bar			Part No.	IC	T ₁	Style
	L ₁	L ₃	D ₂				
0.672 - 0.944	5.25	3.000	0.625	CBR-0625CP*	0.250	0.094	◇ CP or CC
0.672 - 0.944	5.25	3.000	0.625	CBR-0625TP	0.250	0.094	▲ TP
0.825 - 1.087	6.31	4.000	0.750	CBR-0750CP	0.250	0.094	◇ CP or CC
0.825 - 1.087	6.31	4.000	0.750	CBR-0750TP	0.250	0.094	▲ TP
1.050 - 1.320	8.25	5.000	1.000	CBR-1000CP	0.250	0.094	◇ CP or CC
1.050 - 1.320	8.25	5.000	1.000	CBR-1000TP	0.250	0.094	▲ TP
1.300 - 1.600	10.31	6.500	1.250	CBR-1250CP	0.250	0.094	◇ CP or CC
1.300 - 1.600	10.31	6.500	1.250	CBR-1250TP	0.250	0.094	▲ TP

*CBR-0625 style boring system has a minimum bore diameter of 0.750" when using a CC style insert
Imperial (in) = 0.001" adjustment on diameter

B
BORING

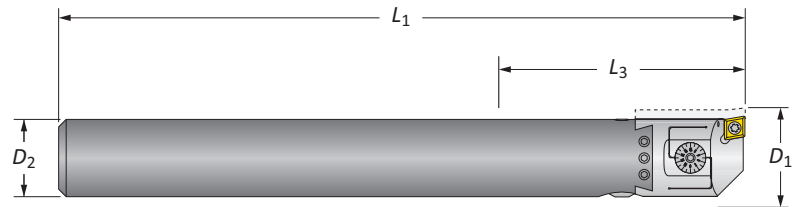

Micro Adjusting

D ₁ Range	Boring Bar			Part No.	IC	T ₁	Style
	L ₁	L ₃	D ₂				
1.050 - 1.320	8.95	3.000	1.000	CBR-1000CPMA	0.250	0.094	◇ CP or CC
1.050 - 1.320	8.95	4.000	1.000	CBR-1000TPMA	0.250	0.094	▲ TP
1.300 - 1.600	11.00	5.000	1.250	CBR-1250CPMA	0.250	0.094	◇ CP or CC
1.300 - 1.600	11.00	6.500	1.250	CBR-1250TPMA	0.250	0.094	▲ TP

The total range of the micro adjustment is 0.006" (0.150mm) on diameter
Imperial (in) = 0.00005" adjustment on diameter

C
REAMING

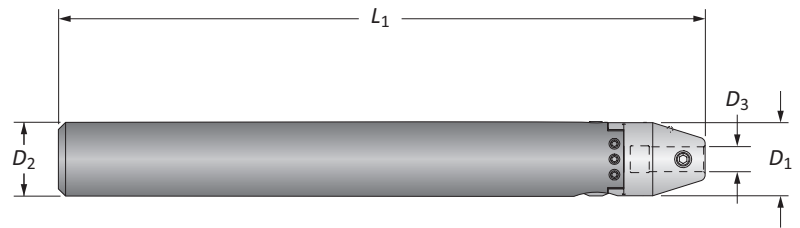

SGL Style

D ₁ Range	Boring Bar			Part No.
	D ₃	L ₁	D ₂	
0.050 - 0.380	0.125	5.25	0.625	CBR-0625SSG
0.050 - 0.470	0.250	6.50	0.750	CBR-0750SH
0.120 - 0.640	0.375	8.69	1.000	CBR-1000SA
0.250 - 0.800	0.500	10.60	1.250	CBR-1250SB

D
BURNISHING

F
THREADING

X
SPECIALS

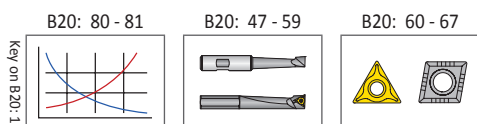

ⓘ = Imperial (in)
Ⓜ = Metric (mm)
Inserts sold separately



Cri-Bar Adjustable Boring Bar Replacement Parts

Round Shank

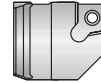
**1** Body**2** Insert Holder**3** Dial Screw

Standard Adjusting

Bar Part No.	Hardware Kit	Components			Torx Screw	Torx Wrench
		1	2	3		
CBR-0625CP	CB0625-HDW	CBR0625-BD	CB0750CP-IH	DS-MDB0750	TXS-116-1	8T-7
CBR-0625TP	CB0625-HDW	CBR0625-BD	CB0750TP-IH	DS-MDB0750	TXS-116-1	8T-7
CBR-0750CP	CB0750-HDW	CBR0750-BD	CB0750CP-IH	DS-MDB0750	TXS-116-1	8T-7
CBR-0750TP	CB0750-HDW	CBR0750-BD	CB0750TP-IH	DS-MDB0750	TXS-116-1	8T-7
CBR-1000CP	CB1000-HDW	CBR1000-BD	CB1000CP-IH	DS-MDB1000	TXS-116-1	8T-7
CBR-1000TP	CB1000-HDW	CBR1000-BD	CB1000TP-IH	DS-MDB1000	TXS-116-1	8T-7
CBR-1250CP	CB1250-HDW	CBR1250-BD	CB1250CP-IH	DS-MDB1000	TXS-116-1	8T-7
CBR-1250TP	CB1250-HDW	CBR1250-BD	CB1250TP-IH	DS-MDB1000	TXS-116-1	8T-7

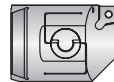
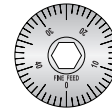
**1** Body**2** Insert Holder**3** Dial Screw**4** Micro Dial Screw

Micro Adjusting

Bar Part No.	Hardware Kit	Components				Wedge	Torx Screw	Torx Wrench
		1	2	3	4			
CBR-1000CPMA	CB1000-HDW	CBR1000-BD	CB1000CPMA-IH	DS-MDB1000	DS-MA1500	MAW-1000	TXS-116-1	8T-7
CBR-1000TPMA	CB1000-HDW	CBR1000-BD	CB1000TPMA-IH	DS-MDB1000	DS-MA1500	MAW-1000	TXS-116-1	8T-7
CBR-1250CPMA	CB1250-HDW	CBR1250-BD	CB1250CPMA-IH	DS-MDB1000	DS-MA1500	MAW-1000	TXS-116-1	8T-7
CBR-1250TPMA	CB1250-HDW	CBR1250-BD	CB1250TPMA-IH	DS-MDB1000	DS-MA1500	MAW-1000	TXS-116-1	8T-7

**1** Body**2** Bar Holder**3** Dial Screw

SGL Style

Bar Part No.	Hardware Kit	Components		
		1	2	3
CBR-0625SG	CB0625-HDW	CBR0625-BD	SGL0625G-BH	DS-MDB0750
CBR-0750SH	CB0750-HDW	CBR0750-BD	SGL0750H-BH	DS-MDB0750
CBR-1000SA	CB1000-HDW	CBR1000-BD	SGL1000A-BH	DS-MDB1000
CBR-1250SB	CB1250-HDW	CBR1250-BD	SGL1250B-BH	DS-MDB1000

i = Imperial (in)**m** = Metric (mm)

Screws sold in multiples of 10

Cri-Bar Adjustable Boring Bars

Square Shank | Bore Diameter Range: 0.050" - 1.600"

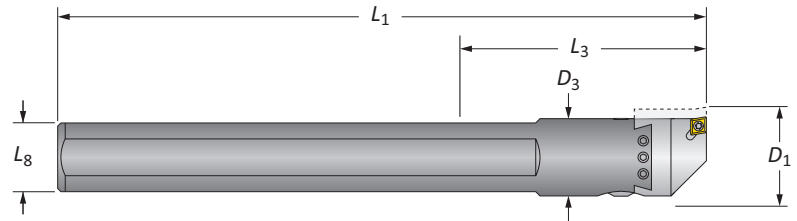

Standard Adjusting

<i>i</i>	Boring Bar					Part No.	IC	Insert	
	D_1 Range	D_3	L_1	L_3	L_8			T_1	Style
	0.672 - 0.944	0.625	5.25	3.000	0.541	CBS-0625CP*	0.250	0.094	◇ CP or CC
	0.672 - 0.944	0.625	5.25	3.000	0.541	CBS-0625TP	0.250	0.094	△ TP
	0.825 - 1.087	0.750	6.31	4.000	0.660	CBS-0750CP	0.250	0.094	◇ CP or CC
	0.825 - 1.087	0.750	6.31	4.000	0.660	CBS-0750TP	0.250	0.094	△ TP
	1.050 - 1.320	1.000	8.25	5.000	0.883	CBS-1000CP	0.250	0.094	◇ CP or CC
	1.050 - 1.320	1.000	8.25	5.000	0.883	CBS-1000TP	0.250	0.094	△ TP
	1.300 - 1.600	1.250	10.31	6.500	1.100	CBS-1250CP	0.250	0.094	◇ CP or CC
	1.300 - 1.600	1.250	10.31	6.500	1.100	CBS-1250TP	0.250	0.094	△ TP

*CBS-0625 style boring system has a minimum bore diameter of 0.750" when using a CC style insert
Imperial (in) = 0.001" adjustment on diameter

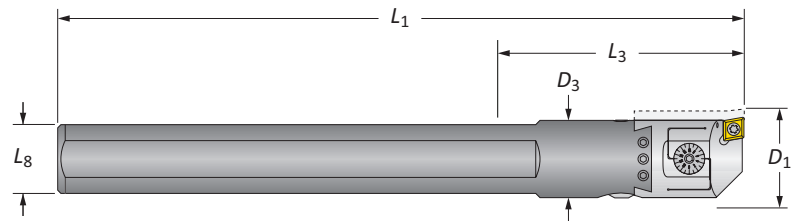

Micro Adjusting

<i>i</i>	Boring Bar					Part No.	IC	Insert	
	D_1 Range	D_3	L_1	L_3	L_8			T_1	Style
	1.050 - 1.320	1.000	8.95	3.000	0.883	CBS-1000CPMA	0.250	0.094	◇ CP or CC
	1.050 - 1.320	1.000	8.95	4.000	0.883	CBS-1000TPMA	0.250	0.094	△ TP
	1.300 - 1.600	1.250	11.00	5.000	1.100	CBS-1250CPMA	0.250	0.094	◇ CP or CC
	1.300 - 1.600	1.250	11.00	6.500	1.100	CBS-1250TPMA	0.250	0.094	△ TP

The total range of the micro adjustment is 0.006" (0.150mm) on diameter
Imperial (in) = 0.00005" adjustment on diameter

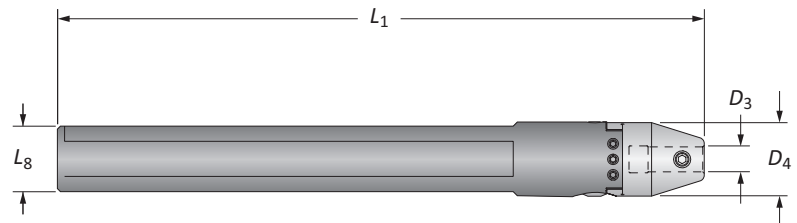

SGL Style

<i>i</i>	Boring Bar					Part No.
	D_1 Range	D_3	D_4	L_1	L_8	
	0.050 - 0.380	0.125	0.625	5.25	0.541	CBS-0625SG
	0.050 - 0.470	0.250	0.750	6.50	0.660	CBS-0750SH
	0.120 - 0.640	0.375	1.000	8.69	0.883	CBS-1000SA
	0.250 - 0.800	0.500	1.250	10.60	1.100	CBS-1250SB

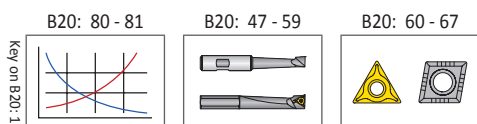

i = Imperial (in)
m = Metric (mm)

Inserts sold separately

Cri-Bar Adjustable Boring Bar Replacement Parts

Square Shank



1 Body

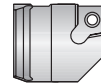

2 Insert Holder



3 Dial Screw

Standard Adjusting

Bar Part No.	Hardware Kit	Components			Torx Screw	Torx Wrench
		1	2	3		
CBS-0625CP	CB0625-HDW	CBS0625-BD	CB0750CP-IH	DS-MDB0750	TXS-116-1	8T-7
CBS-0625TP	CB0625-HDW	CBS0625-BD	CB0750TP-IH	DS-MDB0750	TXS-116-1	8T-7
CBS-0750CP	CB0750-HDW	CBS0750-BD	CB0750CP-IH	DS-MDB0750	TXS-116-1	8T-7
CBS-0750TP	CB0750-HDW	CBS0750-BD	CB0750TP-IH	DS-MDB0750	TXS-116-1	8T-7
CBS-1000CP	CB1000-HDW	CBS1000-BD	CB1000CP-IH	DS-MDB1000	TXS-116-1	8T-7
CBS-1000TP	CB1000-HDW	CBS1000-BD	CB1000TP-IH	DS-MDB1000	TXS-116-1	8T-7
CBS-1250CP	CB1250-HDW	CBS1250-BD	CB1250CP-IH	DS-MDB1000	TXS-116-1	8T-7
CBS-1250TP	CB1250-HDW	CBS1250-BD	CB1250TP-IH	DS-MDB1000	TXS-116-1	8T-7

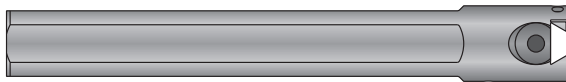

1 Body



2 Insert Holder



3 Dial Screw



4 Micro Dial Screw

Micro Adjusting

Bar Part No.	Hardware Kit	Components				Wedge	Torx Screw	Torx Wrench
		1	2	3	4			
CBS-1000CPMA	CB1000-HDW	CBS1000-BD	CB1000CPMA-IH	DS-MDB1000	DS-MA1500	MAW-1000	TXS-116-1	8T-7
CBS-1000TPMA	CB1000-HDW	CBS1000-BD	CB1000TPMA-IH	DS-MDB1000	DS-MA1500	MAW-1000	TXS-116-1	8T-7
CBS-1250CPMA	CB1250-HDW	CBS1250-BD	CB1250CPMA-IH	DS-MDB1000	DS-MA1500	MAW-1000	TXS-116-1	8T-7
CBS-1250TPMA	CB1250-HDW	CBS1250-BD	CB1250TPMA-IH	DS-MDB1000	DS-MA1500	MAW-1000	TXS-116-1	8T-7



1 Body



2 Bar Holder



3 Dial Screw

SGL Style

Bar Part No.	Hardware Kit	Components		
		1	2	3
CBS-0625SG	CB0625-HDW	CBS0625-BD	SGL0625G-BH	DS-MDB0750
CBS-0750SH	CB0750-HDW	CBS0750-BD	SGL0750H-BH	DS-MDB0750
CBS-1000SA	CB1000-HDW	CBS1000-BD	SGL1000A-BH	DS-MDB1000
CBS-1250SB	CB1250-HDW	CBS1250-BD	SGL1250B-BH	DS-MDB1000

i = Imperial (in)

m = Metric (mm)

Screws sold in multiples of 10

MD Adjustable Boring Bars

Square Shank | Bore Diameter Range: 0.250" - 1.250"

A DRILLING

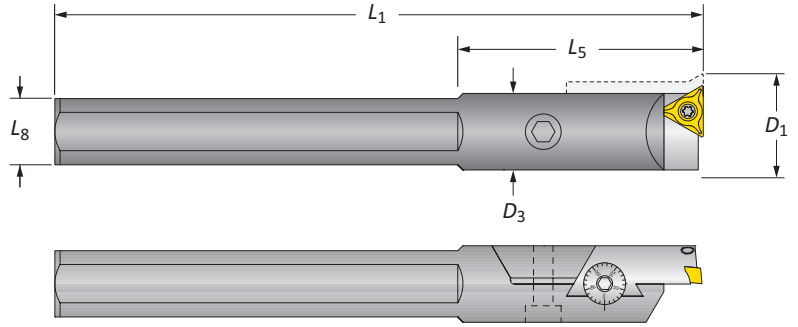
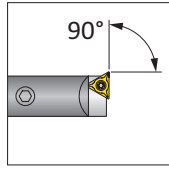

B BORING

	Boring Bar					Part No.	Insert		
	D_1 Range	D_3	L_1	L_5	D_2		IC	T_1	Style
i	0.700 - 0.960	0.625	5.25	3.000	0.541	MDB-0625CP*	0.250	0.094	◇ CP or CC
	0.710 - 0.960	0.625	5.25	3.000	0.541	MDB-0625TP	0.250	0.094	△ TP
	0.850 - 1.200	0.750	6.31	4.000	0.660	MDB-0750CP	0.375	0.156	◇ CP or CC
	0.890 - 1.280	0.750	6.31	4.000	0.660	MDB-0750TP	0.375	0.125	△ TP
	1.100 - 1.670	1.000	8.25	5.000	0.883	MDB-1000CP	0.375	0.156	◇ CP or CC
	1.130 - 1.650	1.000	8.25	5.000	0.883	MDB-1000TP	0.375	0.125	△ TP
	1.370 - 2.330	1.250	10.31	6.500	1.100	MDB-1250CP	0.375	0.156	◇ CP or CC
	1.400 - 2.370	1.250	10.31	6.500	1.100	MDB-1250TP	0.375	0.125	△ TP
m	18 - 27	16	133	3.000	14	MDB-16MT	6.35	2.38	△ TP
	22 - 33	20	160	4.000	18	MDB-20MT	9.53	3.96	△ TP
	27 - 42	25	210	5.000	23	MDB-25MT	9.53	3.96	△ TP
	33 - 60	32	260	6.500	28	MDB-32MT	9.53	3.96	△ TP

*MDB-0625CP style boring system has a minimum bore diameter of 0.750" when using a CC style insert

Imperial (in) = 0.001" adjustment on diameter

Metric (mm) = 0.02mm adjustment on diameter

D BURNISHING

F THREADING

X SPECIALS

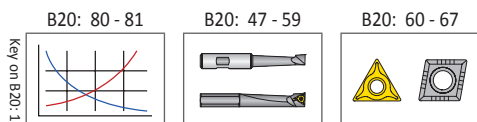

i = Imperial (in)
m = Metric (mm)
Inserts sold separately



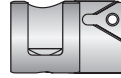

MD Adjustable Boring Bar Replacement Parts

Square Shank

**1** Body**2** Insert Holder**3** Dial Screw

Standard Adjusting

Bar Part No.	Components			 Wedge	 Torx Screw (10)	 Torx Wrench
	1	2	3			
MDB-0625CP	MDB0625-BD	MD0625CP-IH	DS-MDB0625	MDB0625-WEDGE	TXS-116-1	8T-7
MDB-0625TP	MDB0625-BD	MD0625TP-IH	DS-MDB0625	MDB0625-WEDGE	TXS-116-1	8T-7
MDB-0750CP	MDB0750-BD	MD0750CP-IH	DS-MDB0750	MDB0750-WEDGE	TXS-009-1	8T-15
MDB-0750TP	MDB0750-BD	MD0750TP-IH	DS-MDB0750	MDB0750-WEDGE	TXS-100-1	8T-20
MDB-1000CP	MDB1000-BD	MD1000CP-IH	DS-MDB1000	MDB1000-WEDGE	TXS-009-1	8T-15
MDB-1000TP	MDB-1000BD	MD1000TP-IH	DS-MDB1000	MDB1000-WEDGE	TXS-100-1	8T-20
MDB-1250CP	MDB1250-BD	MD1250CP-IH	DS-MDB1250	MDB1250-WEDGE	TXS-009-1	8T-15
MDB-1250TP	MDB1250-BD	MD1250TP-IH	DS-MDB1250	MDB1250-WEDGE	TXS-100-1	8T-20
MDB-16MT	MDB16M-BD	MD16MTP-IH	DS-MDB16M	MDB16M-WEDGE	TXS-116-1	8T-7
MDB-20MT	MDB20M-BD	MD20MTP-IH	DS-MDB20M	MDB20M-WEDGE	TXS-100-1	8T-20
MDB-25MT	MDB25M-BD	MD25MTP-IH	DS-MDB25M	MDB25M-WEDGE	TXS-100-1	8T-20
MDB-32MT	MDB32M-BD	MD32MTP-IH	DS-MDB32M	MDB32M-WEDGE	TXS-100-1	8T-20

i = Imperial (in)
m = Metric (mm)

Screws sold in multiples of 10

Criterion Shanks

V Flange | BT Flange

A DRILLING

B BORING

C REAMING

D BURNISHING

E THREADING

X SPECIALS

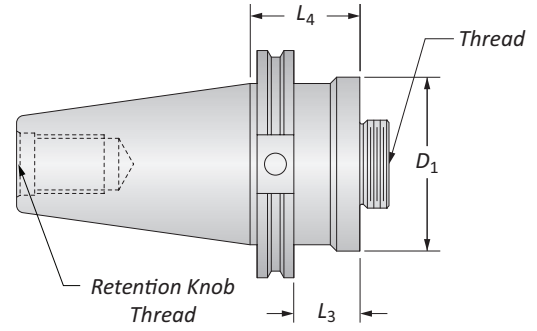

V Flange Shank

Style	D ₁	L ₃	Shank			Retention Knob Thread	Part No.
			L ₄	Thread	Retention Knob Thread		
CAT40	1.50	0.350	1.75	7/8"-20	5/8"-11	CB1500-CV40	
CAT40	2.00	1.000	1.88	7/8"-20	5/8"-11	CB2000-CV40	
CAT40	2.50	1.000	1.88	1-1/2"-18	5/8"-11	CB2500-CV40	
CAT40	3.00	1.750	1.88	1-1/2"-18	5/8"-11	CB3000-CV40	
i CAT50	1.50	0.350	1.75	7/8"-20	1"-8	CB1500-CV50	
CAT50	2.00	1.000	1.88	7/8"-20	1"-8	CB2000-CV50	
CAT50	2.50	1.000	1.88	1-1/2"-18	1"-8	CB2500-CV50	
CAT50	3.00	1.750	1.88	1-1/2"-18	1"-8	CB3000-CV50	
CAT50	3.38	1.250	2.13	2-1/4"-10	1"-8	CB6000-CV50	

NOTE: Taper ground to AT3 tolerance

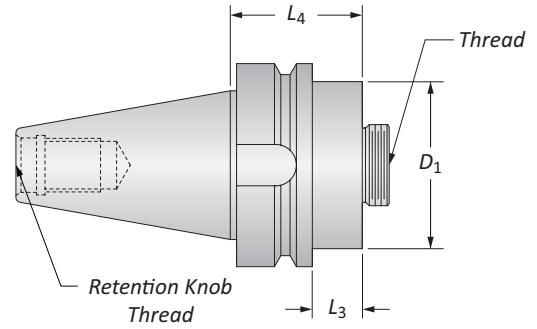

BT Flange Shank

Style	D ₁	L ₃	Shank			Retention Knob Thread	Part No.
			L ₄	Thread	Retention Knob Thread		
BT30	1.50	0.859	1.75	7/8"-20	M12 x 1.75	CB1500-BT30	
BT40	1.50	0.422	1.75	7/8"-20	M16 x 2	CB1500-BT40	
BT40	2.00	1.900	1.56	7/8"-20	M16 x 2	CB2000-BT40	
BT40	2.50	1.900	2.06	1-1/2"-18	M16 x 2	CB2500-BT40	
i BT40	3.00	1.900	2.06	1-1/2"-18	M16 x 2	CB3000-BT40	
BT50	1.50	0.236	1.75	7/8"-20	M24 x 3	CB1500-BT50	
BT50	2.00	0.040	1.56	7/8"-20	M24 x 3	CB2000-BT50	
BT50	3.00	1.900	2.06	1-1/2"-18	M24 x 3	CB3000-BT50	
BT50	3.38	0.625	2.13	2-1/4"-10	M24 x 3	CB6000-BT50	

NOTE: Taper ground to AT3 tolerance

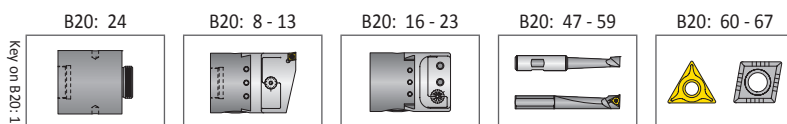

i = Imperial (in)
m = Metric (mm)



Criterion Shanks

DIN 69871A | DIN 2080

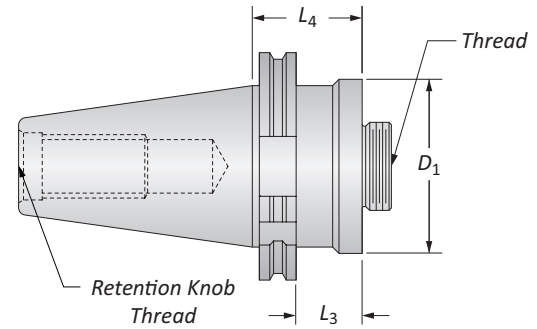

DIN 69871A Shank

	Style	D ₁	Shank			Retention Knob Thread	Part No.
			L ₃	L ₄	Thread		
Ⓜ	DIN 40	38.00	19.00	38.40	7/8"-20	M16 x 2.0	CB038M-DIN40
	DIN 40	50.00	22.00	41.50	7/8"-20	M16 x 2.0	CB050M-DIN40
	DIN 40	76.00	45.00	48.00	1-1/2"-18	M16 x 2.0	CB076M-DIN40
	DIN 50	38.00	19.00	38.40	7/8"-20	M24 x 3.0	CB038M-DIN50
	DIN 50	50.00	22.00	41.50	7/8"-20	M24 x 3.0	CB050M-DIN50
	DIN 50	76.00	22.00	48.00	1-1/2"-18	M24 x 3.0	CB076M-DIN50

NOTE: Taper ground to AT3 tolerance

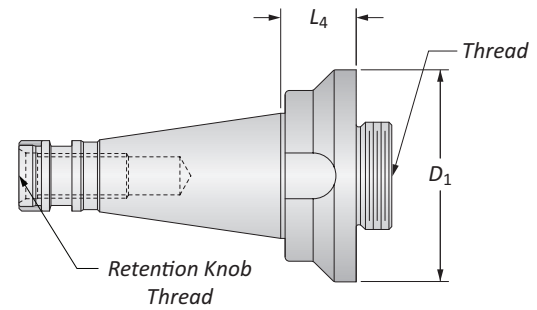

DIN 2080 Shank

	Style	D ₁	Shank			Retention Knob Thread	Part No.
			L ₃	L ₄	Thread		
Ⓜ	SK-30	38.00	11.00	19.60	7/8"-20	1/2"-13	CB038M-ISO30
	SK-30	50.00	17.00	25.70	7/8"-20	1/2"-13	CB050M-ISO30
	SK-40	38.00	11.00	21.10	7/8"-20	5/8"-11	CB038M-ISO40
	SK-40	50.00	11.00	27.70	7/8"-20	5/8"-11	CB050M-ISO40
	SK-40	76.00	22.00	27.70	1-1/2"-18	5/8"-11	CB076M-ISO40
	SK-50	38.00	11.00	39.40	7/8"-20	1"-8	CB038M-ISO50
	SK-50	50.00	11.00	39.40	7/8"-20	1"-8	CB050M-ISO50
	SK-50	76.00	36.00	39.40	1-1/2"-18	1"-8	CB076M-ISO50

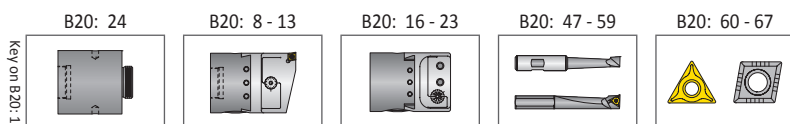

Ⓜ = Imperial (in)
Ⓜ = Metric (mm)

Criterion Shanks

Morse Taper | NMTB Taper

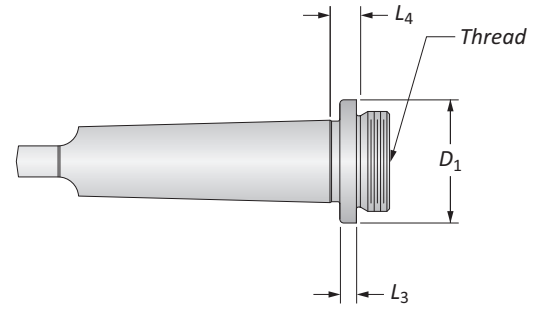

Morse Taper Shank

Style	D_1	Shank			Part No.
		L_3	L_4	Thread	
2 Taper	1.11	0.250	0.44	7/8"-20	MT2-375THD87520*
2 Taper	1.11	0.250	0.44	7/8"-20	MT2-087520
3 Taper	1.11	-	0.44	7/8"-20	MT3-087520
3 Taper	1.86	0.250	0.44	1-1/2"-18	MT3-150018
4 Taper	1.11	0.250	0.25	7/8"-20	MT4-087520
4 Taper	1.86	0.250	0.50	1-1/2"-18	MT4-150018
5 Taper	1.86	0.250	0.62	1-1/2"-18	MT5-150018

*Item features a 3/8-16 thread instead of tang

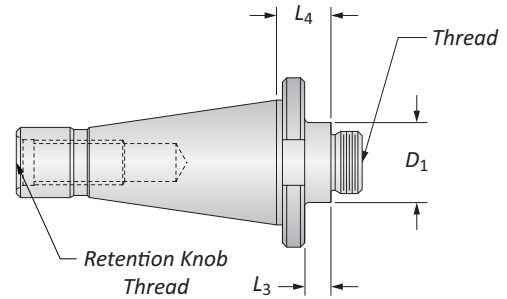

NMTB Taper Shank

Style	D_1	Shank			Retention Knob Thread	Part No.
		L_3	L_4	Thread		
NMTB 30	1.11	0.300	0.78	7/8"-20	1/2"-13	NMTB30-087520
NMTB 30	1.86	0.900	1.05	1-1/2"-18	1/2"-13	NMTB30-150018
NMTB 40	1.11	0.300	0.77	7/8"-20	5/8"-11	NMTB40-087520
NMTB 40	1.86	0.625	1.04	1-1/2"-18	5/8"-11	NMTB40-150018
NMTB 50	1.11	0.500	1.25	7/8"-20	1"-8	NMTB50-087520
NMTB 50	1.86	0.500	1.25	1-1/2"-18	1"-8	NMTB50-150018
NMTB 50	3.38	0.500	1.25	2-1/4"-10	1"-8	NMTB50-225010

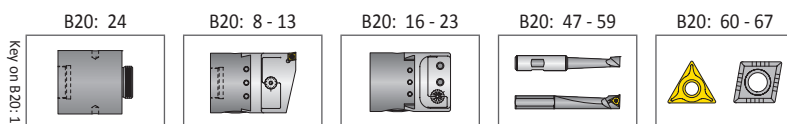

i = Imperial (in)
m = Metric (mm)



Criterion Shanks

HSK

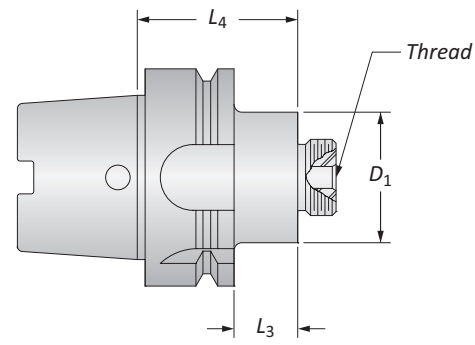

HSK Shank

	Style	D_1	Shank			Part No.
			L_3	L_4	Thread	
i	HSK63	1.50	0.700	1.75	7/8"-20	CB1500-HSK63A
	HSK63	2.00	0.700	1.75	7/8"-20	CB2000-HSK63A
	HSK63	3.00	2.000	2.25	1-1/2"-18	CB3000-HSK63A
	HSK100	1.50	0.500	1.75	7/8"-20	CB1500-HSK100A
	HSK100	2.00	0.500	2.25	7/8"-20	CB2000-HSK100A
	HSK100	3.00	0.500	2.25	1-1/2"-18	CB3000-HSK100A

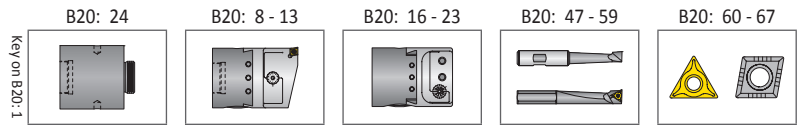

i = Imperial (in)
m = Metric (mm)

Criterion Shanks

R-8 | Straight

DRILLING

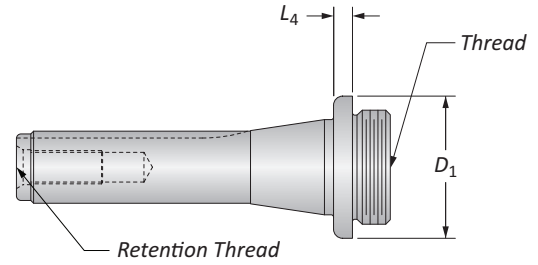

BORING

R-8 Shank

	Shank				Part No.
	D_1	L_4	Thread	Retention Thread	
i	1.11	0.47	7/8"-20	7/16"-20	R8-087520
	1.86	0.37	1-1/2"-18	7/16"-20	R8-150018

REAMING

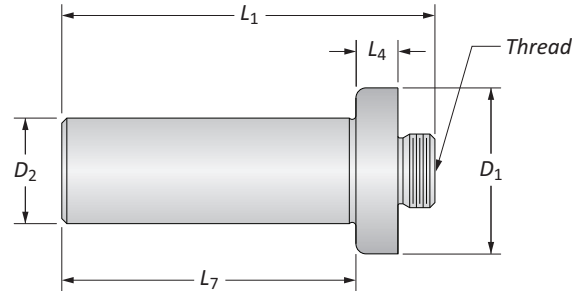

BURNISHING

Straight Shank

	Shank						Part No.
	D_1	D_2	L_4	L_7	L_1	Thread	
	1.11	0.500	0.250	2.000	2.250	7/8"-20	SS0500-087520
	1.11	0.625	0.250	2.370	2.630	7/8"-20	SS0625-087520
	1.11	0.750	0.250	2.750	3.000	7/8"-20	SS0750-087520
	1.11	1.000	0.250	3.120	3.370	7/8"-20	SS1000-087520
i	1.86	0.750	0.250	3.120	3.370	1-1/2"-18	SS0750-150018
	1.86	1.000	0.250	3.120	3.370	1-1/2"-18	SS1000-150018
	1.86	1.250	0.250	3.870	4.130	1-1/2"-18	SS1250-150018
	1.86	1.500	0.250	4.630	4.880	1-1/2"-18	SS1500-150018
	1.86	2.000	-	6.380	6.380	1-1/2"-18	SS2000-150018

THREADING

SPECIALS

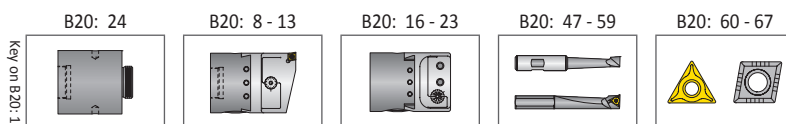

i = Imperial (in)
m = Metric (mm)

Criterion Boring Bars Nomenclature

Criterion Boring Bars

CBT	00800500	G	QL
1	2	3	4

1. Boring Bar Style	2. Max Bore Depth	3. Shank Diameter	4. Type																		
<p>CBT = Solid carbide boring tool</p> <p>SBT = Steel shank brazed carbide boring tool</p> <p>TA = Triangle insert boring tool (standard bore depth)</p> <p>TAS = Triangle insert boring tool (short bore depth)</p>		<table border="1"> <thead> <tr> <th>Imperial</th> <th>Metric</th> </tr> </thead> <tbody> <tr> <td>A = 0.375</td> <td>A = 10mm</td> </tr> <tr> <td>B = 0.500</td> <td>B = 12mm</td> </tr> <tr> <td>C = 0.625</td> <td>C = 16mm</td> </tr> <tr> <td>D = 0.750</td> <td>D = 20mm</td> </tr> <tr> <td>E = 1.000</td> <td>E = 25mm</td> </tr> <tr> <td>F = 1.500</td> <td></td> </tr> <tr> <td>G = 0.125</td> <td></td> </tr> <tr> <td>H = 0.250</td> <td></td> </tr> </tbody> </table>	Imperial	Metric	A = 0.375	A = 10mm	B = 0.500	B = 12mm	C = 0.625	C = 16mm	D = 0.750	D = 20mm	E = 1.000	E = 25mm	F = 1.500		G = 0.125		H = 0.250		<p>QL = Qualified length</p> <p>HB = Helical back rake</p> <p>S = Square shank</p>
Imperial	Metric																				
A = 0.375	A = 10mm																				
B = 0.500	B = 12mm																				
C = 0.625	C = 16mm																				
D = 0.750	D = 20mm																				
E = 1.000	E = 25mm																				
F = 1.500																					
G = 0.125																					
H = 0.250																					

Criterion Boring Bars

CFX	500	CS
1	2	3

1. Boring Bar Style	2. Shank Diameter	3. Material														
<p>CFX = 80° rhombic insert (long bore depth)</p> <p>TFX = Triangle insert (long bore depth)</p> <p>CHB = Cross hole boring bar</p> <p>BFB = Boring and facing bar</p>	<table border="1"> <thead> <tr> <th>Imperial</th> <th>Metric</th> </tr> </thead> <tbody> <tr> <td>0375 = 0.375</td> <td>012M = 12mm</td> </tr> <tr> <td>0500 = 0.500</td> <td>020M = 20mm</td> </tr> <tr> <td>0625 = 0.625</td> <td>025M = 25mm</td> </tr> <tr> <td>0750 = 0.750</td> <td></td> </tr> <tr> <td>1000 = 1.000</td> <td></td> </tr> <tr> <td>1500 = 1.500</td> <td></td> </tr> </tbody> </table>	Imperial	Metric	0375 = 0.375	012M = 12mm	0500 = 0.500	020M = 20mm	0625 = 0.625	025M = 25mm	0750 = 0.750		1000 = 1.000		1500 = 1.500		<p>CS = Carbide shank</p> <p>HM = Heavy metal</p>
Imperial	Metric															
0375 = 0.375	012M = 12mm															
0500 = 0.500	020M = 20mm															
0625 = 0.625	025M = 25mm															
0750 = 0.750																
1000 = 1.000																
1500 = 1.500																



Standard



Steel



Heavy Metal



Carbide Shank



Cross Hole



Boring and Facing



Solid Carbide



Qualified Length



Helical Rake



Round Shank

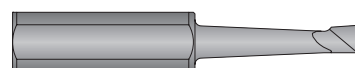

Square Shank

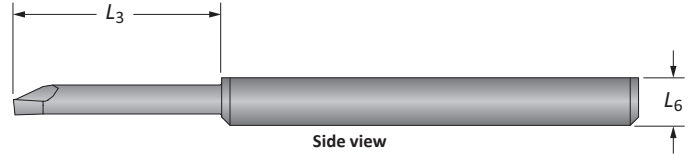
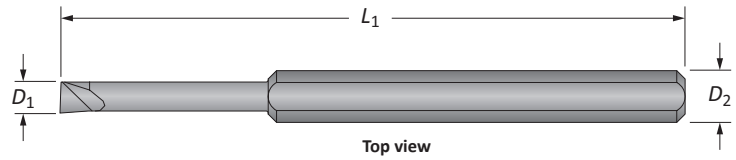
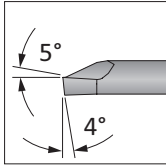
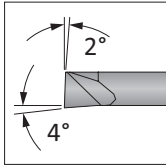

Criterion Boring Bars

Carbide | Solid Carbide



Boring Bar					
D_1	L_3	L_1	L_6	D_2	Part No.
0.050	0.150	1.500	0.115	0.125	CBT-00500150G
0.050	0.300	1.500	0.115	0.125	CBT-00500300G
0.050	0.400	1.500	0.115	0.125	CBT-00500400G
0.060	0.150	1.500	0.115	0.125	CBT-00600150G
0.060	0.300	1.500	0.115	0.125	CBT-00600300G
0.060	0.500	1.500	0.115	0.125	CBT-00600500G
0.080	0.150	1.500	0.115	0.125	CBT-00800150G
0.080	0.300	1.500	0.115	0.125	CBT-00800300G
i 0.080	0.500	1.500	0.115	0.125	CBT-00800500G
0.100	0.200	1.500	0.115	0.125	CBT-01000200G
0.100	0.400	1.500	0.115	0.125	CBT-01000400G
0.100	0.600	1.500	0.115	0.125	CBT-01000600G
0.100	0.700	1.500	0.115	0.125	CBT-01000700G
0.110	0.200	1.500	0.115	0.125	CBT-01100200G
0.110	0.400	1.500	0.115	0.125	CBT-01100400G
0.110	0.600	1.500	0.115	0.125	CBT-01100600G
0.110	0.700	1.500	0.115	0.125	CBT-01100700G

Adapters

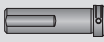
D_1	 Style 1	 Style 2	 Style 3	 Style 4
0.125	-	-	BTH-01250250	BTH-01250375
i 0.125	-	-	-	BTH-01250500
0.125	-	-	-	BTH-01250625
0.125	-	-	-	BTH-01250750

For complete adapter details, see page B20: 25

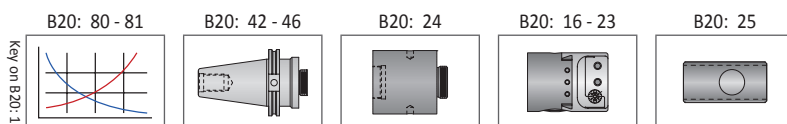

i = Imperial (in)
m = Metric (mm)



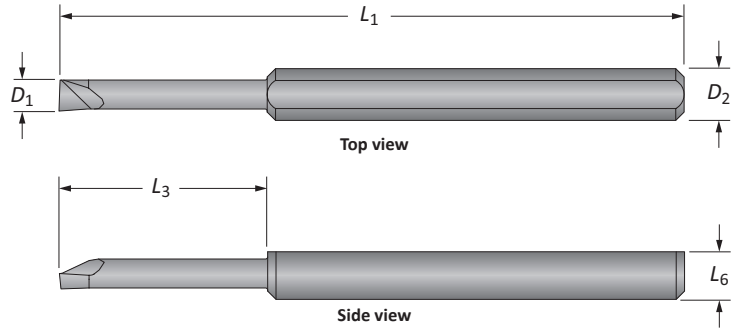
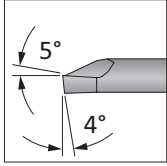
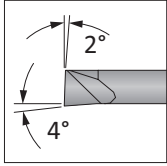

Criterion Boring Bars

Carbide | Solid Carbide



	Boring Bar					Part No.
	D_1	L_3	L_1	L_6	D_2	
	0.120	0.250	2.500	0.230	0.250	CBT-01200250H
	0.120	0.375	2.500	0.230	0.250	CBT-01200375H
	0.120	0.500	2.500	0.230	0.250	CBT-01200500H
	0.120	0.625	2.500	0.230	0.250	CBT-01200625H
	0.120	0.750	2.500	0.230	0.250	CBT-01200750H
	0.140	0.250	2.500	0.230	0.250	CBT-01400250H
	0.140	0.375	2.500	0.230	0.250	CBT-01400375H
	0.140	0.500	2.500	0.230	0.250	CBT-01400500H
	0.140	0.625	2.500	0.230	0.250	CBT-01400625H
	0.140	0.750	2.500	0.230	0.250	CBT-01400750H
	0.160	0.375	2.500	0.230	0.250	CBT-01600375H
	0.160	0.500	2.500	0.230	0.250	CBT-01600500H
	0.160	0.625	2.500	0.230	0.250	CBT-01600625H
i	0.160	0.750	2.500	0.230	0.250	CBT-01600750H
	0.160	0.875	2.500	0.230	0.250	CBT-01600875H
	0.180	0.500	2.500	0.230	0.250	CBT-01800500H
	0.180	0.625	2.500	0.230	0.250	CBT-01800625H
	0.180	0.750	2.500	0.230	0.250	CBT-01800750H
	0.180	0.875	2.500	0.230	0.250	CBT-01800875H
	0.180	1.000	2.500	0.230	0.250	CBT-01801000H
	0.180	1.125	2.500	0.230	0.250	CBT-01801125H
	0.200	0.500	2.500	0.230	0.250	CBT-02000500H
	0.200	0.625	2.500	0.230	0.250	CBT-02000625H
	0.200	0.750	2.500	0.230	0.250	CBT-02000750H
	0.200	0.875	2.500	0.230	0.250	CBT-02000875H
	0.200	1.000	2.500	0.230	0.250	CBT-02001000H
	0.200	1.250	2.500	0.230	0.250	CBT-02001250H

Adapters

D_1	 Style 1	 Style 2	 Style 3	 Style 4
i 0.250	BTH-02500375	-	-	BTH-02500625
0.250	BTH-02500500	-	-	BTH-02500750

For complete adapter details, see page B20: 25

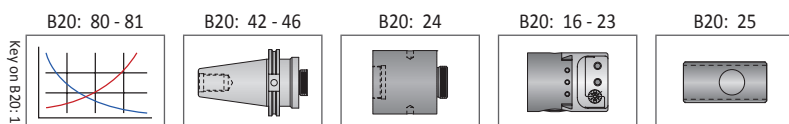

i = Imperial (in)
m = Metric (mm)

Criterion Boring Bars

Carbide | Helical Rake

A
DRILLING

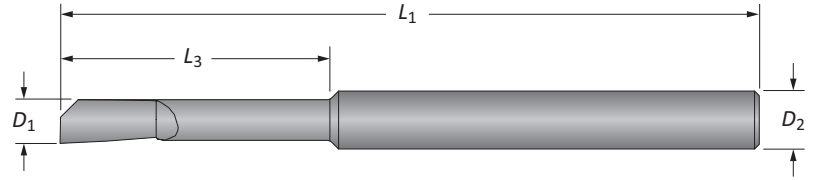

B
BORING

	Boring Bar				Part No.
	D_1	L_3	L_1	D_2	
i	0.035	0.125	1.500	0.125 ϕ	CBT-00350125GHB
	0.035	0.187	1.500	0.125 ϕ	CBT-00350187GHB
	0.040	0.187	1.500	0.125 ϕ	CBT-00400187GHB
	0.040	0.250	1.500	0.125 ϕ	CBT-00400250GHB
	0.050	0.312	1.500	0.125 ϕ	CBT-00500312GHB
	0.060	0.375	1.500	0.125 ϕ	CBT-00600375GHB
	0.070	0.437	1.500	0.125 ϕ	CBT-00700437GHB
	0.080	0.500	1.500	0.125 ϕ	CBT-00800500GHB
	0.090	0.500	1.500	0.125 ϕ	CBT-00900500GHB
	0.100	0.562	1.500	0.125 ϕ	CBT-01000562GHB
	0.120	0.625	1.500	0.125 ϕ	CBT-01200625GHB
	0.120	1.000	1.500	0.125 ϕ	CBT-01201000GHB

C
REAMING

Tool Holders

	Holder			Part No.
	D_1	D_2	L_1	
i	0.250	0.410 ϕ	1.275	CHD-0250QL
	0.375	0.410 ϕ	1.970	CHD-0375QL
	0.500	0.410 ϕ	1.970	CHD-0500QL
	0.625	0.410 ϕ	2.300	CHD-0625QL
	0.750	0.410 ϕ	2.300	CHD-0750QL

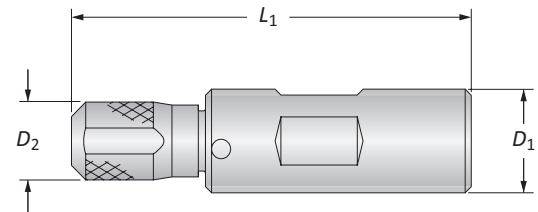

Tool holder comes with collet nut (CHD-0250CN) and wrench (CHD-125CNW)
Collet sold separately

F
THREADING

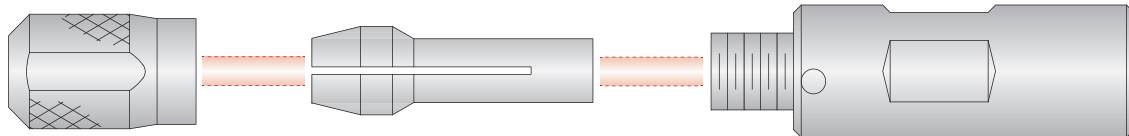

Collet Nut
CHD-0250CN

Collet
CHD-125C
(sold separately)

Tool Holder
CHD-XXXXQL

X
SPECIALS

B20: 80 - 81 B20: 42 - 46 B20: 24 B20: 16 - 23

key on B20: 1

i = Imperial (in)
m = Metric (mm)

Criterion Boring Bars

Carbide | Qualified Length

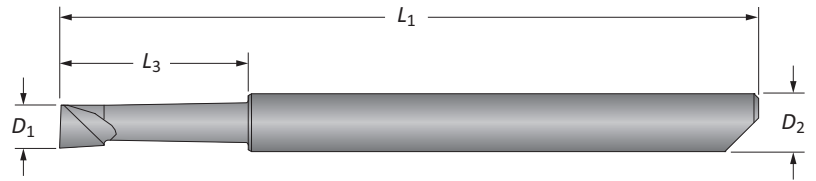
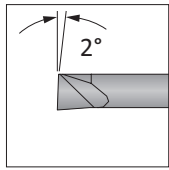

	Boring Bar				Part No.
	D_1	L_3	L_1	D_2	
	0.050	0.150	1.500	0.125 ϕ	CBT-00500150GQL
	0.050	0.300	1.500	0.125 ϕ	CBT-00500300GQL
	0.050	0.400	1.500	0.125 ϕ	CBT-00500400GQL
	0.060	0.150	1.500	0.125 ϕ	CBT-00600150GQL
	0.060	0.300	1.500	0.125 ϕ	CBT-00600300GQL
	0.060	0.500	1.500	0.125 ϕ	CBT-00600500GQL
	0.080	0.150	1.500	0.125 ϕ	CBT-00800150GQL
	0.080	0.300	1.500	0.125 ϕ	CBT-00800300GQL
	0.080	0.500	1.500	0.125 ϕ	CBT-00800500GQL
i	0.100	0.200	1.500	0.125 ϕ	CBT-01000200GQL
	0.100	0.400	1.500	0.125 ϕ	CBT-01000400GQL
	0.100	0.600	1.500	0.125 ϕ	CBT-01000600GQL
	0.100	0.700	1.500	0.125 ϕ	CBT-01000700GQL
	0.110	0.200	1.500	0.125 ϕ	CBT-01100200GQL
	0.110	0.400	1.500	0.125 ϕ	CBT-01100400GQL
	0.110	0.600	1.500	0.125 ϕ	CBT-01100600GQL
	0.110	0.700	1.500	0.125 ϕ	CBT-01100700GQL

Tool Holders

	Holder			Part No.
	D_1	D_2	L_1	
	0.250	0.410 ϕ	1.275	CHD-0250QL
	0.375	0.410 ϕ	1.970	CHD-0375QL
i	0.500	0.410 ϕ	1.970	CHD-0500QL
	0.625	0.410 ϕ	2.300	CHD-0625QL
	0.750	0.410 ϕ	2.300	CHD-0750QL

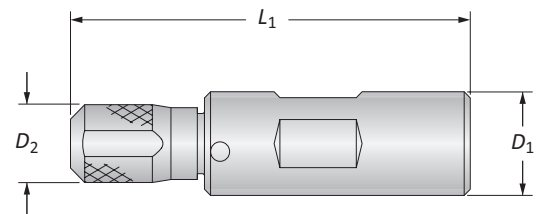

Tool holder comes with collet nut (CHD-0250CN) and wrench (CHD-125CNW)
Collet sold separately

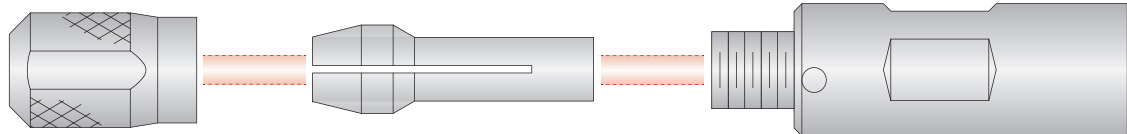

Collet Nut
CHD-0250CN

Collet
CHD-125C
(sold separately)

Tool Holder
CHD-XXXXQL

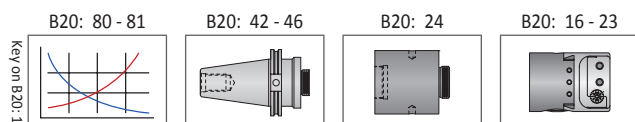

Key on B20-1

i = Imperial (in)
m = Metric (mm)

A **Criterion Boring Bars**

Brazed Carbide | Round Shank

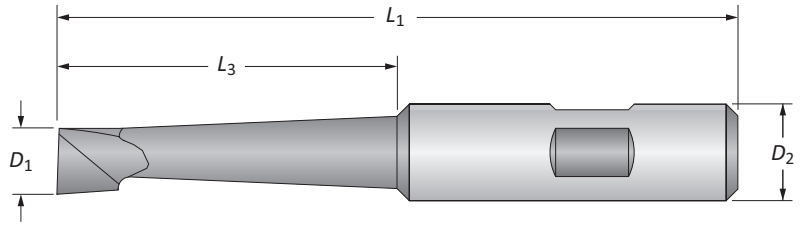
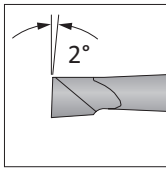

D_1	Boring Bar			Part No.
	L_3	L_1	D_2	
0.062	0.250	1.590	0.375	SBT-00620250A
0.093	0.375	1.750	0.375	SBT-00930375A
0.125	0.500	1.875	0.375	SBT-01250500A
0.187	0.812	2.156	0.375	SBT-01870812A
0.250	1.125	2.468	0.375	SBT-02501125A
0.312	1.500	2.812	0.375	SBT-03121500A
0.375	1.875	3.187	0.375	SBT-03751875A
0.500	2.312	3.500	0.375	SBT-05002312A
0.062	0.250	1.590	0.500	SBT-00620250B
0.093	0.375	1.750	0.500	SBT-00930375B
0.125	0.250	1.656	0.500	SBT-01250250B
0.125	0.500	1.875	0.500	SBT-01250500B
0.187	0.312	1.812	0.500	SBT-01870312B
0.187	0.812	2.156	0.500	SBT-01870812B
0.250	0.437	2.000	0.500	SBT-02500437B
0.250	1.125	2.468	0.500	SBT-02501125B
0.312	0.562	2.187	0.500	SBT-03120562B
0.312	1.500	2.812	0.500	SBT-03121500B
0.375	0.687	2.375	0.500	SBT-03750687B
0.375	1.750	3.187	0.500	SBT-03751750B
0.500	0.812	2.562	0.500	SBT-05000812B
i 0.500	2.187	3.500	0.500	SBT-05002187B
0.125	0.500	2.250	0.625	SBT-01250500C
0.187	0.812	2.562	0.625	SBT-01870812C
0.250	1.125	2.875	0.625	SBT-02501125C
0.375	1.750	3.500	0.625	SBT-03751750C
0.500	2.125	3.812	0.625	SBT-05002125C
0.625	2.500	4.125	0.625	SBT-06252500C
0.500	1.312	2.937	0.750	SBT-05001312D
0.500	2.187	3.945	0.750	SBT-05002187D
0.625	2.750	4.468	0.750	SBT-06252750D
0.750	1.531	3.156	0.750	SBT-07501531D
0.750	3.000	4.687	0.750	SBT-07503000D
1.000	1.750	3.375	0.750	SBT-10001750D
1.000	3.500	5.125	0.750	SBT-10003500D
1.250	4.000	5.562	0.750	SBT-12504000D
0.500	2.375	4.250	1.000	SBT-05002375E
0.625	2.625	4.468	1.000	SBT-06252625E
0.750	2.875	4.687	1.000	SBT-07502875E
1.000	1.750	3.375	1.000	SBT-10001750E
1.000	3.500	5.125	1.000	SBT-10003500E
1.250	1.968	3.593	1.000	SBT-12501968E
1.250	3.875	5.562	1.000	SBT-12503875E

X See adapter options on following page

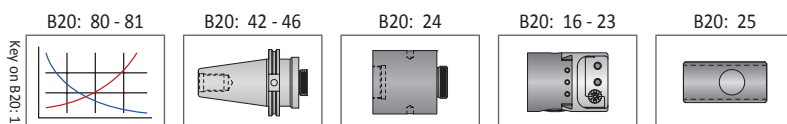

i = Imperial (in)
m = Metric (mm)



Criterion Boring Bars

Brazed Carbide | Square Shank

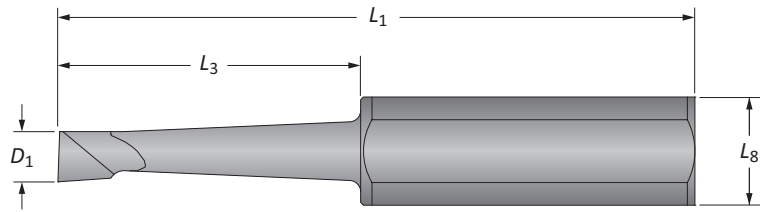
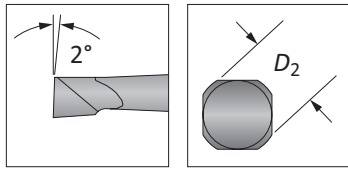

		Boring Bar				Part No.
	D_1	L_3	L_1	L_8	D_2	
i	0.062	0.250	1.590	0.437	0.500	SBT-00620250BS
	0.093	0.375	1.750	0.437	0.500	SBT-00930375BS
	0.125	0.250	1.656	0.437	0.500	SBT-01250250BS
	0.125	0.500	1.875	0.437	0.500	SBT-01250500BS
	0.187	0.312	1.812	0.437	0.500	SBT-01870312BS
	0.187	0.812	2.156	0.437	0.500	SBT-01870812BS
	0.250	0.437	2.000	0.437	0.500	SBT-02500437BS
	0.250	1.125	2.468	0.437	0.500	SBT-02501125BS
	0.312	0.562	2.187	0.437	0.500	SBT-03120562BS
	0.312	1.500	2.812	0.437	0.500	SBT-03121500BS
	0.375	0.687	2.375	0.437	0.500	SBT-03750687BS
	0.375	1.750	3.187	0.437	0.500	SBT-03751750BS
	0.500	0.812	2.562	0.437	0.500	SBT-05000812BS
	0.500	2.187	3.500	0.437	0.500	SBT-05002187BS
m	3	12	48	8	10	SBT-03012MA
	4	20	55	8	10	SBT-04020MA
	6	28	62	8	10	SBT-06028MA
	8	37	71	8	10	SBT-08037MA
	10	48	81	8	10	SBT-10048MA
	12	55	90	8	10	SBT-12055MA
	3	12	48	10	12	SBT-03012MB
	4	20	55	10	12	SBT-04020MB
	6	28	62	10	12	SBT-06028MB
	8	37	71	10	12	SBT-08037MB
	10	48	81	10	12	SBT-10048MB
	12	55	90	10	12	SBT-12055MB
m	12	63	107	18	20	SBT-12063MD
	16	71	113	18	20	SBT-16071MD
	19	78	119	18	20	SBT-19078MD
	25	90	130	18	20	SBT-25090MD
	32	100	141	18	20	SBT-32100MD
	12	60	107	22	25	SBT-12060ME
	16	67	113	22	25	SBT-16067ME
	19	74	119	22	25	SBT-19074ME
	25	89	130	22	25	SBT-25089ME
	32	100	141	22	25	SBT-32100ME

Adapters

	D_1	Style 1	Style 2	Style 3	Style 4
i	0.500	-	BTH-05001000	BTH-05000750	-
m	10	BTH-10M12M	BTH-10M25M	BTH-10M20M	-
	12	-	BTH-12M25M	BTH-12M20M	-
	20	-	-	BTH-20M25M	-

For complete adapter details, see page B20: 25

i = Imperial (in)
m = Metric (mm)



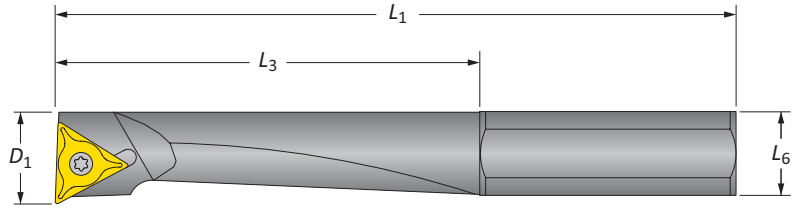
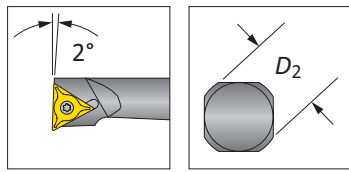

Criterion Boring Bars

TA Insert | Imperial



<i>D</i>	Boring Bars				<i>D</i> ₂	Part No.	Insert		
	<i>D</i> ₁	<i>L</i> ₃	<i>L</i> ₁	<i>L</i> ₆			<i>IC</i>	<i>T</i> ₁	Style
i	0.250	1.062	2.437	0.310	0.375	TA-02501062A	0.156	0.063	▲ WCMT
	0.312	1.437	2.750	0.310	0.375	TA-03121437A	0.156	0.078	▲ TC
	0.375	1.750	3.062	0.310	0.375	TA-03751750A	0.156	0.078	▲ TC
	0.250	1.062	2.437	0.437	0.500	TA-02501062B	0.156	0.063	▲ WCMT
	0.312	1.437	2.750	0.437	0.500	TA-03121437B	0.156	0.078	▲ TC
	0.375	1.750	3.062	0.437	0.500	TA-03751750B	0.156	0.078	▲ TC
	0.437	2.062	3.375	0.437	0.500	TA-04372062B	0.250	0.094	▲ TP
	0.500	2.187	3.500	0.437	0.500	TA-05002187B	0.250	0.094	▲ TP
	0.375	1.750	3.062	0.531	0.625	TA-03751750C	0.156	0.078	▲ TC
	0.500	2.187	3.500	0.531	0.625	TA-05002187C	0.250	0.094	▲ TP
	0.625	2.750	4.390	0.531	0.625	TA-06252750C	0.250	0.094	▲ TP
	0.500	2.500	4.250	0.641	0.750	TA-05002500D	0.250	0.094	▲ TP
	0.750	3.000	4.687	0.641	0.750	TA-07503000D	0.375	0.125	▲ TP
	1.000	3.500	5.125	0.641	0.750	TA-10003500D	0.375	0.125	▲ TP
	1.250	4.000	5.562	0.641	0.750	TA-12504000D	0.375	0.125	▲ TP
	0.500	2.375	4.250	0.859	1.000	TA-05002375E	0.250	0.094	▲ TP
	0.750	2.875	4.687	0.859	1.000	TA-07502875E	0.375	0.125	▲ TP
	1.000	3.500	5.125	0.859	1.000	TA-10003500E	0.375	0.125	▲ TP
1.250	3.875	5.562	0.859	1.000	TA-12503875E	0.375	0.125	▲ TP	

Adapters

<i>D</i>	<i>D</i> ₁	 Style 1	 Style 2	 Style 3	 Style 4
i	0.375	BTH-03750500	BTH-03750750	-	-
	0.375	-	BTH-03751000	-	-
	0.500	-	BTH-05001000	BTH-05000750	-
	0.750	-	-	BTH-07501000	-

For complete adapter details, see page B20: 25

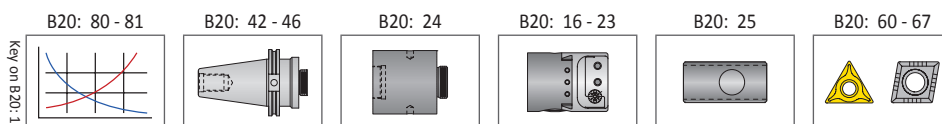

i = Imperial (in)
m = Metric (mm)
 Inserts sold separately



Criterion Boring Bars

TA Insert | Metric

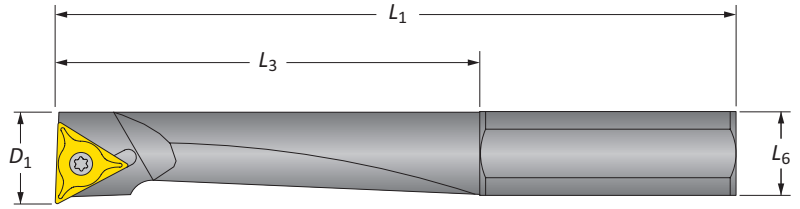
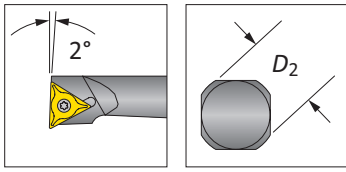

D ₁	Boring Bars				D ₂	Part No.	IC	Insert	
	L ₃	L ₁	L ₆	T ₁				Style	
6	12	47	8	10	TAS-06M012A	3.97	1.60	△ WCMT	
6	27	62	8	10	TA-06M027A	3.97	1.60	△ WCMT	
8	16	50	8	10	TAS-08M016A	3.97	1.98	△ TC	
8	36	70	8	10	TA-08M036A	3.97	1.98	△ TC	
10	20	54	8	10	TAS-10M020A	3.97	1.98	△ TC	
10	45	78	8	10	TA-10M045A	3.97	1.98	△ TC	
6	12	47	10	12	TAS-06M012B	3.97	1.60	△ WCMT	
6	27	63	10	12	TA-06M027B	3.97	1.60	△ WCMT	
8	16	50	10	12	TAS-08M016B	3.97	1.98	△ TC	
8	36	71	10	12	TA-08M036B	3.97	1.98	△ TC	
10	20	54	10	12	TAS-10M020B	3.97	1.98	△ TC	
10	45	80	10	12	TA-10M045B	3.97	1.98	△ TC	
12	24	57	10	12	TAS-12M024B	6.35	2.38	△ TC	
12	54	86	10	12	TA-12M054B	6.35	2.38	△ TC	
10	20	67	18	20	TAS-10M020D	3.97	1.98	△ TC	
10	45	92	18	20	TA-10M045D	3.97	1.98	△ TC	
12	24	70	18	20	TAS-12M024D	6.35	2.38	△ TC	
12	54	100	18	20	TA-12M054D	6.35	2.38	△ TC	
16	32	76	18	20	TAS-16M032D	9.53	3.96	△ TC	
16	72	116	18	20	TA-16M072D	6.35	2.38	△ TC	
20	40	82	18	20	TAS-20M040D	6.35	2.38	△ TC	
20	90	131	18	20	TA-20M090D	9.53	3.96	△ TC	
10	20	69	23	25	TAS-10M020E	3.97	1.98	△ TC	
10	45	94	23	25	TA-10M045E	3.97	1.98	△ TC	
12	24	73	23	25	TAS-12M024E	6.35	2.38	△ TC	
12	54	102	23	25	TA-12M054E	6.35	2.38	△ TC	
16	32	78	23	25	TAS-16M032E	9.53	3.96	△ TC	
16	72	118	23	25	TA-16M072E	9.53	3.96	△ TC	
20	40	85	23	25	TAS-20M040E	9.53	3.96	△ TC	
20	90	135	23	25	TA-20M090E	9.53	3.96	△ TC	
25	50	92	23	25	TAS-25M050E	9.53	3.96	△ TC	
25	113	155	23	25	TA-25M113E	9.53	3.96	△ TC	

Adapters

D ₁	Style 1	Style 2	Style 3	Style 4
10	BTH-10M12M	BTH-10M25M	BTH-10M20M	-
12	-	BTH-12M25M	BTH-12M20M	-
20	-	-	BTH-20M25M	-

For complete adapter details, see page B20: 25

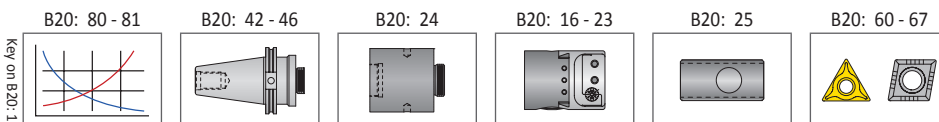

= Imperial (in)
 = Metric (mm)
 Inserts sold separately

Criterion Boring Bars

Steel CFX / TFX

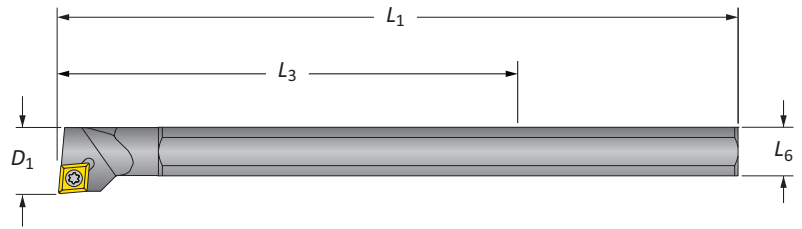
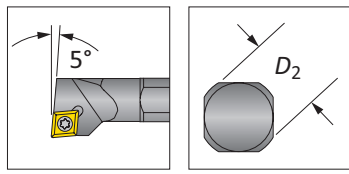

Steel CFX



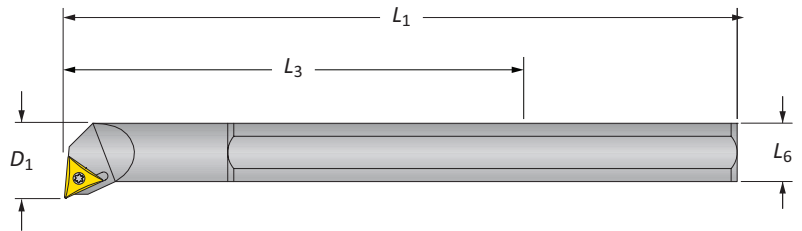
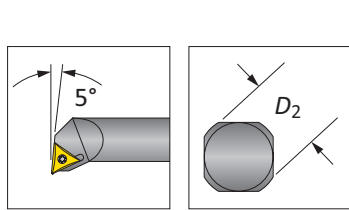

i	Boring Bar					Part No.	Insert		
	D ₁	L ₃	L ₁	L ₆	D ₂		IC	T ₁	Style
	0.75	2.500	6.00	0.43	0.500	CFX-0500	0.250	0.094	◇ CP or CC
	1.00	4.000	8.00	0.66	0.750	CFX-0750	0.375	0.156	◇ CP or CC
	1.38	5.000	10.00	0.88	1.000	CFX-1000	0.375	0.156	◇ CP or CC
	1.76	6.750	10.60	1.31	1.500	CFX-1500	0.500	0.188	◇ CC



Steel TFX

i	Boring Bar					Part No.	Insert		
	D ₁	L ₃	L ₁	L ₆	D ₂		IC	T ₁	Style
	0.75	2.500	6.00	0.43	0.500	TFX-0500	0.250	0.094	△ TP
	1.00	4.000	8.00	0.66	0.750	TFX-0750	0.375	0.125	△ TP
	1.38	5.000	10.00	0.88	1.000	TFX-1000	0.375	0.125	△ TP

Adapters

i	D ₁				
		Style 1	Style 2	Style 3	Style 4
	0.500	-	BTH-05001000	BTH-05000750	-
	0.750	-	-	BTH-07501000	-
	1.000	-	-	BTH-10001500	-

For complete adapter details, see page B20: 25

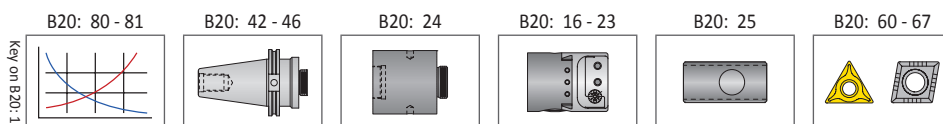

i = Imperial (in)
m = Metric (mm)
Inserts sold separately



Criterion Boring Bars

Heavy Metal CFX / TFX

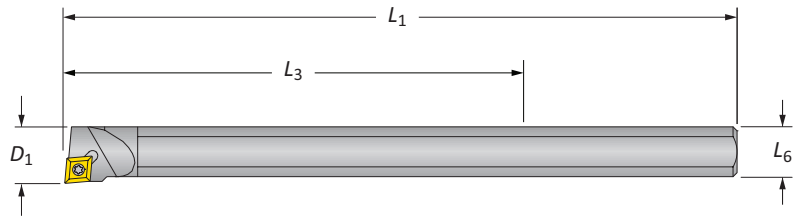
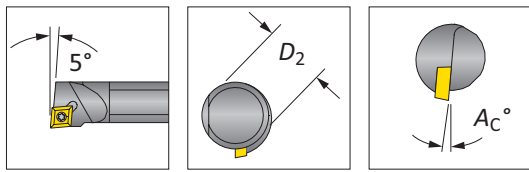

Heavy Metal CFX

D ₁ Range	Boring Bar					Part No.	Insert		
	L ₃	Angle	L ₁	L ₆	D ₂		IC	T ₁	Style
0.197 - 1.500	1.500	0°	3.00	0.180	0.187	CFX-0187HM	0.156	0.040	◇ CD
0.260 - 1.500	1.500	0°	3.00	0.230	0.250	CFX-0250HM	0.156	0.040	◇ CD
0.365 - 2.250	2.250	10°	4.00	0.290	0.312	CFX-0312HM	0.250	0.094	◇ CP or CC
0.425 - 2.250	2.250	10°	4.00	0.340	0.375	CFX-0375HM	0.250	0.094	◇ CP or CC
0.550 - 3.250	3.250	5°	6.00	0.455	0.500	CFX-0500HM	0.250	0.094	◇ CP or CC
0.688 - 4.250	4.250	8°	8.00	0.565	0.625	CFX-0625HM	0.375	0.156	◇ CP or CC
0.832 - 4.250	4.750	8°	10.00	0.680	0.750	CFX-0750HM	0.375	0.156	◇ CP or CC

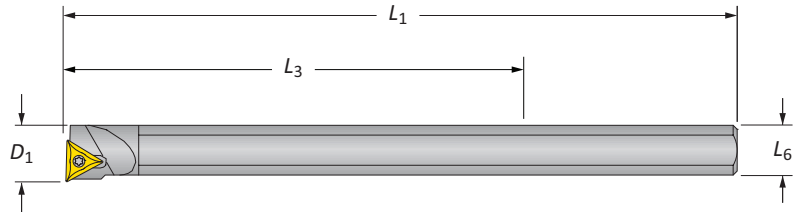
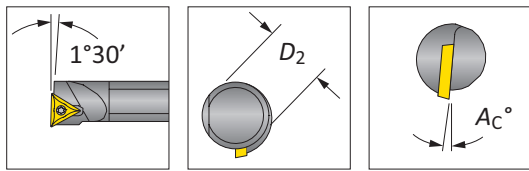

Heavy Metal TFX

D ₁ Range	Boring Bar					Part No.	Insert		
	L ₃	Angle	L ₁	L ₆	D ₂		IC	T ₁	Style
0.425 - 2.250	2.250	8°	4.00	0.340	0.375	TFX-0375HM	0.219	0.094	△ TC
0.550 - 3.250	3.250	5°	6.00	0.455	0.500	TFX-0500HM	0.250	0.094	△ TC

Adapters

D ₁	Style 1	Style 2	Style 3	Style 4
0.187	BTH-01870375	-	-	-
0.187	BTH-01870500	-	-	-
0.250	BTH-02500375	-	-	BTH-02500625
0.250	BTH-02500500	-	-	BTH-02500750
0.250	BTH-02500625	-	-	-
0.312	BTH-03120375	-	-	-
0.312	BTH-03120500	-	-	-
0.375	BTH-03750500	BTH-03750750	-	-
0.375	-	BTH-03751000	-	-
0.500	-	BTH-05001000	BTH-05000750	-
0.625	BTH-06250750	-	BTH-06251000	-
0.750	-	-	BTH-07501000	-

For complete adapter details, see page B20: 25

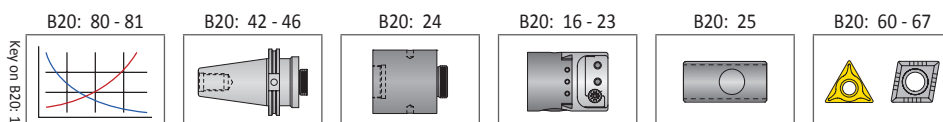

ⓘ = Imperial (in)
 ⓘ = Metric (mm)
 Inserts sold separately

Criterion Boring Bars

Carbide Shank CFX / TFX

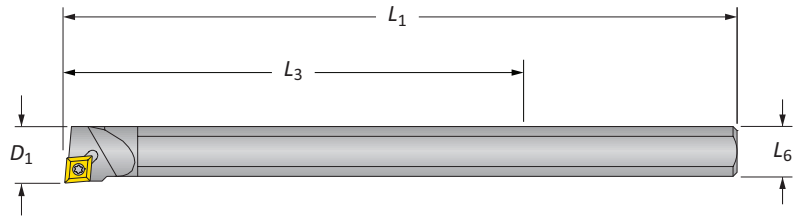
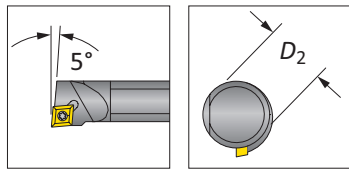

Carbide CFX

i	D ₁		Boring Bar				Part No.	Insert		
	CP Insert	CC Insert	L ₃	L ₁	L ₆	D ₂		IC	T ₁	Style
	0.500 - 3.000	0.750	3.000	6.00	0.34	0.375	CFX-0375CS	0.250	0.094	◇ CP or CC
	0.625 - 4.500	0.750	4.500	8.00	0.47	0.500	CFX-0500CS	0.250	0.094	◇ CP or CC
	0.750 - 5.500	0.750	5.500	10.00	0.59	0.625	CFX-0625CS	0.250	0.094	◇ CP or CC
	0.875 - 6.000	1.230	6.000	10.00	0.70	0.750	CFX-0750CS	0.375	0.156	◇ CP or CC

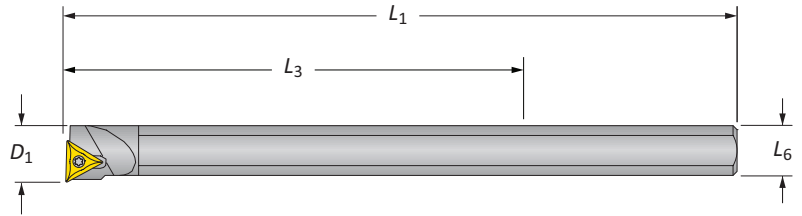
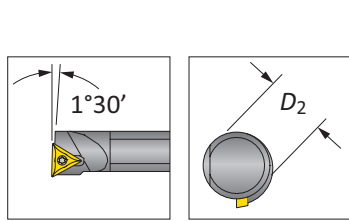

Carbide TFX

i	D ₁		Boring Bar				Part No.	Insert		
		L ₃	L ₁	L ₆	D ₂	IC		T ₁	Style	
	0.500 - 3.000	3.000	6.00	0.34	0.375	TFX-0375CS	0.250	0.094	△ TP	
	0.625 - 4.500	4.500	8.00	0.47	0.500	TFX-0500CS	0.250	0.094	△ TP	
	0.750 - 5.500	5.500	10.00	0.59	0.625	TFX-0625CS	0.375	0.125	△ TP	
	0.875 - 6.000	6.000	10.00	0.70	0.750	TFX-0750CS	0.375	0.125	△ TP	

Adapters

D ₁	Style 1	Style 2	Style 3	Style 4
0.375	BTH-03750500	BTH-03750750	-	-
0.375	-	BTH-03751000	-	-
0.500	-	BTH-05001000	BTH-05000750	-
0.625	BTH-06250750	-	BTH-06251000	-
0.750	-	-	BTH-07501000	-

For complete adapter details, see page B20: 25

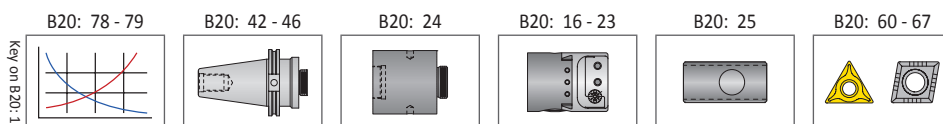

i = Imperial (in)
m = Metric (mm)
Inserts sold separately



Criterion Boring Bars

Cross Hole

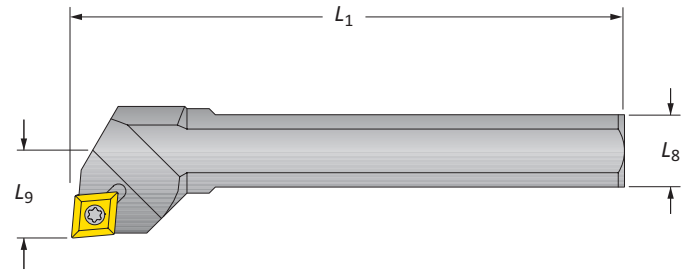
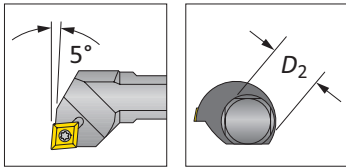

	Boring Bar					Part No.	Insert		
	D_1	L_9	L_1	L_8	D_2		IC	T_1	Style
i	2.875 - 6.687*	0.53	2.75	0.43	0.500	CHB-0500	0.250	0.094	◇ CP or CC
	4.937 - 11.000*	0.77	4.75	0.64	0.750	CHB-0750	0.375	0.156	◇ CP or CC
	5.625 - 13.437*	0.87	5.31	0.85	1.000	CHB-1000	0.375	0.156	◇ CP or CC
	9.093 - 21.500*	1.17	9.00	1.31	1.500	CHB-1500	0.500	0.188	◇ CC
m	73.00 - 169.00*	13	72	10	12	CHB-012M	6.35	2.39	◇ CP or CC
	126.00 - 279.00*	19	123	18	20	CHB-020M	9.53	3.97	◇ CP or CC
	143.00 - 341.00*	22	134	23	25	CHB-025M	9.53	3.97	◇ CP or CC

*NOTICE: Cross hole bars should always be secured in the bar holder with at least two set screws

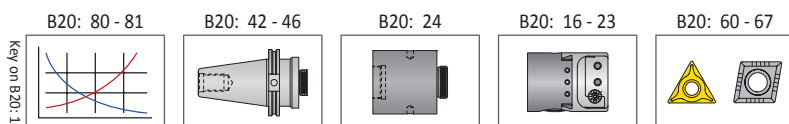

i = Imperial (in)
 m = Metric (mm)
 Inserts sold separately

Criterion Boring Inserts Nomenclature

Criterion Boring Inserts

TCMT18150	T	MF	P02
1	2	3	4



80° Rhombic









80° Triangle







80° Trigon

1. Standard ANSI / ISO Designation			2. Material	3. Chipbreaker		4. Coating
Rhombic	Triangle	Trigon	C = Carbide	FA	MB	Blank = Uncoated
CDCD	TCMT	WCMT	T = Cermet	FB	MC	T = TiN
CCET	TPGT		B = CBN	FC	MD	C01 = CVD
CCGT	TPMT			FD	ME	C02 = CVD
CCMT	TPGW			FE	MF	C03 = CVD
CCGW				FG		C04 = CVD
CCMW						P01 = PVD
CPMT						P02 = PVD

80° Rhombic

Insert Geometry	Designed for / Notes
 FB	Finishing applications <ul style="list-style-type: none"> • Light to medium depths of cut • Low feed rates
 FC	Chip control in finishing applications <ul style="list-style-type: none"> • Varied depths of cut • Low feed rates • Low cutting forces
 FD	Finishing applications <ul style="list-style-type: none"> • Non-ferrous metals • Large rake angle provides smooth chip flow with less adhesion for a good surface finish
 MB	Medium to finishing applications <ul style="list-style-type: none"> • Wide breaker dot and pocket
 MD	Medium and finishing applications <ul style="list-style-type: none"> • Non-ferrous metals • Positive chip groove and polished surface reduces chip adhesion
 ME	Medium and finishing applications <ul style="list-style-type: none"> • Stainless steel and heat-resistant alloys • Large rake angle and circular edge give good chip control

80° Triangle

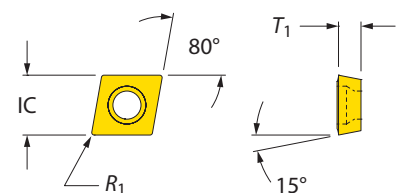

Insert Geometry	Designed for / Notes
 FA	Finishing applications <ul style="list-style-type: none"> • Light depths of cut • Low feed rates
 FE	Finishing applications <ul style="list-style-type: none"> • Low carbon materials • Sticky materials
 FG	Finishing applications <ul style="list-style-type: none"> • Ferrous materials with good chip control
 MC	Medium and finishing applications <ul style="list-style-type: none"> • Cast iron
 MF	Medium general purpose applications



ISO Application Areas

P Steel	N Non-ferrous
M Stainless steel	S Heat resistant
K Cast iron	H Hard materials

Recommendation Key

	Recommended
	Secondary

Reference Key

Symbol	Attribute
IC	Inscribed circle
R₁	Nose radius
T₁	Insert thickness

Criterion Inserts

80° Rhombic | CD•• | CP••

CD••

Imperial (in)			Metric (mm)			Part No.
IC	T ₁	R ₁	IC	T ₁	R ₁	
0.156	0.040	0.002	3.97	1.02	0.05	CDCD513002...
0.156	0.040	0.007	3.97	1.02	0.18	CDCD513007...

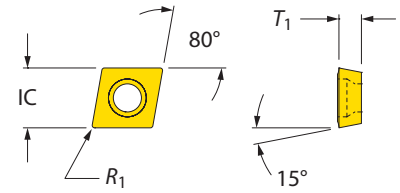

	Part No.	ISO Description	Carbide		Cermet		CBN	P		M	K	N	S	H	Torx Screw	Torx Wrench
			Uncoated	Coated	Uncoated	Coated		Free Cutting	Carbon / Alloy	Stainless	Grey Cast Iron	Nodular Cast Iron	Non-ferrous	Heat Resistant		
CDCD	CDCD513002C2	-	•							◆	◆	◆			TXS-001-1	8T-6
	CDCD513002C2T	-		•						◆		◆			TXS-001-1	8T-6
	CDCD513002C6	-	•					◆	◆						TXS-001-1	8T-6
	CDCD513007C2T	-		•						◆	◆	◆			TXS-001-1	8T-6
	CDCD513007C26T	-		•					◆	◆					TXS-001-1	8T-6

CP••

Imperial (in)			Metric (mm)			Part No.
IC	T ₁	R ₁	IC	T ₁	R ₁	
0.250	0.094	0.008	6.35	2.38	0.20	CP••2150...
0.250	0.094	0.016	6.35	2.38	0.40	CP••2151...
0.375	0.156	0.016	9.53	3.97	0.40	CP••3251...
0.375	0.156	0.031	9.53	3.97	0.80	CP••3252...

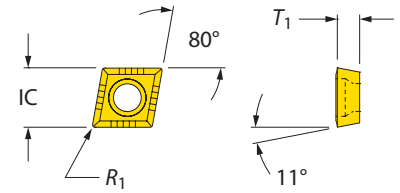

	Part No.	ISO Description	Carbide		Cermet		CBN	P		M	K	N	S	H	Torx Screw	Torx Wrench
			Uncoated	Coated	Uncoated	Coated		Free Cutting	Carbon / Alloy	Stainless	Grey Cast Iron	Nodular Cast Iron	Non-ferrous	Heat Resistant		
CPMT	CPMT2150C2T	060202		•							◆	◆			TXS-116-1	8T-7
	CPMT2150C6T	060202		•				◆	◆						TXS-116-1	8T-7
	CPMT2151C2T	060204		•							◆	◆			TXS-116-1	8T-7
	CPMT2151C6T	060204		•							◆	◆			TXS-116-1	8T-7
	CPMT3251C2T	09T304		•							◆	◆			TXS-009-1	8T-15
	CPMT3251C6T	09T304		•					◆	◆					TXS-009-1	8T-15
	CPMT3252C6T	09T308		•							◆	◆			TXS-009-1	8T-15

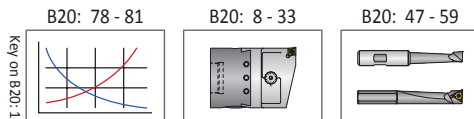

◆ = Recommended
 ✦ = Secondary
 Inserts supplied in packs of 10
 Screws sold in multiples of 10

A DRILLING
 B BORING
 C REAMING
 D BURNISHING
 E THREADING
 X SPECIALS

Criterion Inserts

80° Rhombic | CC••

CC••

Imperial (in)			Metric (mm)			Part No.
IC	T ₁	R ₁	IC	T ₁	R ₁	
0.250	0.094	0.004	6.35	2.38	0.10	CC••21502
0.250	0.094	0.008	6.35	2.38	0.20	CC••21505
0.250	0.094	0.016	6.35	2.38	0.40	CC••2151
0.250	0.094	0.031	6.35	2.38	0.80	CC••2152
0.375	0.156	0.008	9.53	3.97	0.20	CC••32505
0.375	0.156	0.016	9.53	3.97	0.40	CC••3251
0.375	0.156	0.031	9.53	3.97	0.80	CC••3252
0.500	0.188	0.016	12.70	4.76	0.40	CC••431
0.500	0.188	0.031	12.70	4.76	0.80	CC••432

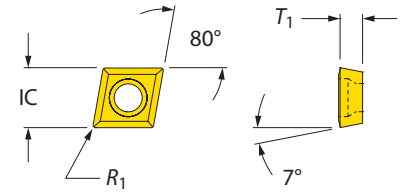

Part No.	ISO Description	Carbide		Cermets		CBN	P	M	K	N	S	H	Torx Screw	Torx Wrench
		Uncoated	Coated	Uncoated	Coated		Free Cutting	Carbon / Alloy	Stainless	Grey Cast Iron	Nodular Cast Iron	Non-ferrous		
CCET														
CCET21502CFBP01	060201		•				◆	◆	❖				TXS-116-1	8T-7
CCET21505CFCP01	060202		•				◆	◆	❖				TXS-116-1	8T-7
CCET21505TMB	060202			•			◆	◆					TXS-116-1	8T-7
CCET32505TFC	09T302			•			◆	◆					TXS-009-1	8T-15
CCGT														
CCGT32505CFD	09T302	•							❖	◆	◆	◆	TXS-009-1	8T-15
CCGT3251CFD	09T304	•							❖	◆	◆	◆	TXS-009-1	8T-15
CCGT3251CMD	09T304	•							❖	◆	◆	◆	TXS-009-1	8T-15
CCGT3252CFD	09T308	•							❖	◆	◆	◆	TXS-009-1	8T-15
CCGT3252CMD	09T308	•							❖	◆	◆	◆	TXS-009-1	8T-15
CCGW														
CCGW21505CMC	060202	•							◆	◆	❖	❖	TXS-116-1	8T-7
CCGW3251CMC	09T304	•							◆	◆	❖	❖	TXS-009-1	8T-15
CCMW														
CCMW2151B1	060204				•			◆				◆	TXS-116-1	8T-7
CCMW2151B2	060204				•				◆	◆			TXS-116-1	8T-7
CCMW2152B1	060208				•			◆				◆	TXS-116-1	8T-7
CCMW2152B2	060208				•				◆	◆			TXS-116-1	8T-7
CCMW3251B1	09T304				•			◆				◆	TXS-009-1	8T-15
CCMW3251B2	09T304				•				◆	◆			TXS-009-1	8T-15
CCMW3252B1	09T308				•			◆				◆	TXS-009-1	8T-15
CCMW3252B2	09T308				•				◆	◆			TXS-009-1	8T-15

B20: 78 - 81 B20: 8 - 33 B20: 47 - 59

key on B20: 1

◆ = Recommended
❖ = Secondary

Inserts supplied in packs of 10
Screws sold in multiples of 10

Criterion Inserts

80° Rhombic | CC••

CC••

Imperial (in)			Metric (mm)			Part No.
IC	T ₁	R ₁	IC	T ₁	R ₁	
0.250	0.094	0.004	6.35	2.38	0.10	CC••21502
0.250	0.094	0.008	6.35	2.38	0.20	CC••21505
0.250	0.094	0.016	6.35	2.38	0.40	CC••2151
0.250	0.094	0.031	6.35	2.38	0.80	CC••2152
0.375	0.156	0.008	9.53	3.97	0.20	CC••32505
0.375	0.156	0.016	9.53	3.97	0.40	CC••3251
0.375	0.156	0.031	9.53	3.97	0.80	CC••3252
0.500	0.188	0.016	12.70	4.76	0.40	CC••431
0.500	0.188	0.031	12.70	4.76	0.80	CC••432

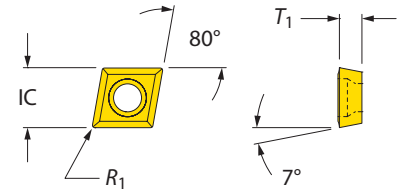

	Part No.	ISO Description	Carbide		Cermet		CBN	P		M	K		N	S		H	Torx Screw	Torx Wrench
			Uncoated	Coated	Uncoated	Coated		Free Cutting	Carbon / Alloy		Grey Cast Iron	Nodular Cast Iron		Non-ferrous	Heat Resistant			
CCMT	CCMT21505CMB01	060202		•				✦	✦		✦	✦					TXS-116-1	8T-7
	CCMT21505CMBP01	060202		•							✦	✦					TXS-116-1	8T-7
	CCMT21505TMB	060202			•			✦	✦								TXS-116-1	8T-7
	CCMT2150C2	060202		•							✦	✦	✦				TXS-116-1	8T-7
	CCMT2150C2T	060202			•						✦	✦	✦				TXS-116-1	8T-7
	CCMT2150C6	060202		•				✦	✦								TXS-116-1	8T-7
	CCMT2150C6T	060202			•			✦	✦								TXS-116-1	8T-7
	CCMT2151C2	060204		•							✦	✦	✦				TXS-116-1	8T-7
	CCMT2151C2T	060204			•						✦	✦	✦				TXS-116-1	8T-7
	CCMT2151C6	060204		•				✦	✦								TXS-116-1	8T-7
	CCMT2151C6T	060204			•			✦	✦								TXS-116-1	8T-7
	CCMT32505TMB	09T302				•		✦	✦								TXS-009-1	8T-15
	CCMT3250C2	09T302		•							✦	✦	✦				TXS-009-1	8T-15
	CCMT3250C2T	09T302			•						✦	✦	✦				TXS-009-1	8T-15
	CCMT3250C6	09T302		•				✦	✦								TXS-009-1	8T-15
	CCMT3250C6T	09T302			•			✦	✦								TXS-009-1	8T-15
	CCMT3251TMB	09T304				•		✦	✦								TXS-009-1	8T-15
	CCMT3251CMEC02	09T304			•					✦					✦		TXS-009-1	8T-15
	CCMT3251C2	09T304		•							✦	✦	✦				TXS-009-1	8T-15
	CCMT3251C2T	09T304			•						✦	✦	✦				TXS-009-1	8T-15
	CCMT3251C6	09T304		•				✦	✦								TXS-009-1	8T-15
	CCMT3251C6T	09T304			•			✦	✦								TXS-009-1	8T-15
	CCMT3252CMEC02	09T308			•					✦					✦		TXS-009-1	8T-15
	CCMT3252C2	09T308		•							✦	✦	✦				TXS-009-1	8T-15
	CCMT3252C2T	09T308			•						✦	✦	✦				TXS-009-1	8T-15
	CCMT3252C6	09T308		•				✦	✦								TXS-009-1	8T-15
	CCMT3252C6T	09T308			•			✦	✦								TXS-009-1	8T-15
	CCMT431CMB01	120404			•			✦	✦								TXS-119-1	8T-15
	CCMT432C6T	120408			•			✦	✦								TXS-119-1	8T-15

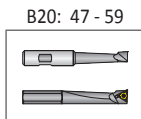
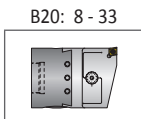
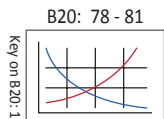

✦ = Recommended
✦ = Secondary

Inserts supplied in packs of 10
Screws sold in multiples of 10

A DRILLING
B BORING
C REAMING
D BURNISHING
E THREADING
X SPECIALS

Criterion Inserts

60° Triangle | TC••

TC••

Imperial (in)			Metric (mm)			Part No.
IC	T ₁	R ₁	IC	T ₁	R ₁	
0.156	0.078	0.016	3.97	1.98	0.40	TC••12121...
0.156	0.078	0.031	3.97	1.98	0.80	TC••12122...
0.219	0.094	0.008	5.56	2.38	0.20	TC••18150...
0.219	0.094	0.016	5.56	2.38	0.40	TC••18151...
0.250	0.094	0.008	6.35	2.38	0.20	TC••2150...
0.250	0.094	0.008	6.35	2.38	0.20	TC••21505...
0.250	0.094	0.016	6.35	2.38	0.40	TC••2151...
0.375	0.156	0.016	9.53	3.97	0.40	TC••3251...

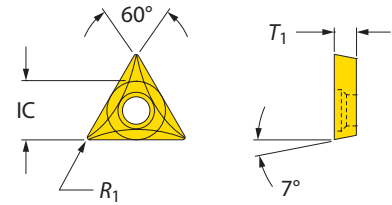

Part No.	ISO Description	Carbide		Cermet		CBN	P	M	K	N	S	H	Torx Screw	Torx Wrench
		Uncoated	Coated	Uncoated	Coated		Free Cutting	Carbon / Alloy	Stainless	Grey Cast Iron	Nodular Cast Iron	Non-ferrous		
TCMT12121C2	06T104	•							◆	◆			TXS-028-1	8T-6
TCMT12121C2T	06T104		•						◆	◆	❖		TXS-028-1	8T-6
TCMT12121C6T	06T104		•				◆	◆					TXS-028-1	8T-6
TCMT12121CFGC04	06T104		•				◆	◆					TXS-028-1	8T-6
TCMT12122C2	06T108	•							◆	◆	❖		TXS-028-1	8T-6
TCMT12122C2T	06T108		•				◆	◆	◆	◆	❖		TXS-028-1	8T-6
TCMT12122C6T	06T108		•										TXS-028-1	8T-6
TCMT18150C2	090202	•							◆	◆	❖		TXS-116-1	8T-7
TCMT18150C2T	090202		•				◆	◆	◆	◆	❖		TXS-116-1	8T-7
TCMT18150C6	090202	•					◆	◆					TXS-116-1	8T-7
TCMT18150C6T	090202		•										TXS-116-1	8T-7
TCMT18150TMF	090202			•			◆	◆					TXS-116-1	8T-7
TCMT18150TMFP02	090202				•		❖	❖	◆				TXS-116-1	8T-7
TCMT18151TMF	090204			•			◆	◆					TXS-116-1	8T-7
TCMT18151TMFP02	090204				•		❖	❖	◆				TXS-116-1	8T-7
TCMT2150C2	110202	•							◆	◆	❖		TXS-116-1	8T-7
TCMT2150C2T	110202		•						◆	◆	❖		TXS-116-1	8T-7
TCMT2150C6	110202	•					◆	◆					TXS-116-1	8T-7
TCMT2150C6T	110202		•				◆	◆					TXS-116-1	8T-7
TCMT2150TMF	110202			•			◆	◆					TXS-116-1	8T-7
TCMT2150TMFP02	110202				•		❖	❖	◆				TXS-116-1	8T-7
TCMT2151TMF	110204			•			◆	◆					TXS-116-1	8T-7
TCMT2151TMFP02	110204				•		❖	❖	◆				TXS-116-1	8T-7
TCMT3251C6	16T304	•					◆	◆					TXS-100-1	8T-20
TCMT3251C6T	16T304		•				◆	◆					TXS-100-1	8T-20

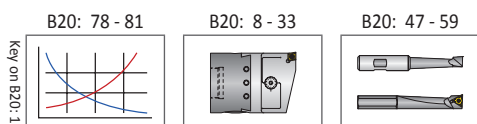

◆ = Recommended
❖ = Secondary

Inserts supplied in packs of 10
Screws sold in multiples of 10



Criterion Inserts

60° Triangle | TP••

TP••

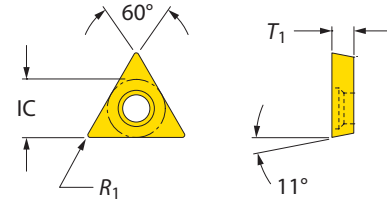
Imperial (in)			Metric (mm)			Part No.
IC	T ₁	R ₁	IC	T ₁	R ₁	
0.250	0.094	0.002	6.35	2.38	0.05	TP••2150...
0.250	0.094	0.016	6.35	2.38	0.40	TP••2151...
0.250	0.094	0.031	6.35	2.38	0.80	TP••2152...
0.375	0.125	0.008	9.53	3.18	0.40	TP••3205
0.375	0.125	0.016	9.53	3.18	0.40	TP••321...
0.375	0.125	0.031	9.53	3.18	0.80	TP••322...
0.375	0.156	0.016	9.53	3.97	0.40	TP••3251...
0.375	0.156	0.031	9.53	3.97	0.80	TP••3252...

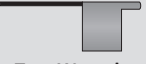

	Part No.	ISO Description	Carbide		Cermet		CBN	P	M	K	N	S	H		
			Uncoated	Coated	Uncoated	Coated	Free Cutting	Carbon / Alloy	Stainless	Grey Cast Iron	Nodular Cast Iron	Non-ferrous	Heat Resistant		
TPGT	TPGT2151C2	110204	•							♦	♦	✦		TXS-116-1	8T-7
	TPGT2151C2T	110204		•						♦	♦	✦		TXS-116-1	8T-7
	TPGT2151C6	110204	•					♦	♦					TXS-116-1	8T-7
	TPGT2151C6T	110204		•				♦	♦					TXS-116-1	8T-7
	TPGT2152C2	110208	•							♦	♦	✦		TXS-116-1	8T-7
	TPGT2152C2T	110208		•						♦	♦	✦		TXS-116-1	8T-7
	TPGT2152C6	110208	•					♦	♦					TXS-116-1	8T-7
	TPGT2152C6T	110208		•				♦	♦					TXS-116-1	8T-7
	TPGT321C2	160304	•							♦	♦	✦		TXS-100-1	8T-20
	TPGT321C2T	160304		•						♦	♦	✦		TXS-100-1	8T-20
	TPGT321C6	160304	•					♦	♦					TXS-100-1	8T-20
	TPGT321C6T	160304		•				♦	♦					TXS-100-1	8T-20
	TPGT322C2	160308	•							♦	♦	✦		TXS-100-1	8T-20
	TPGT322C2T	160308		•						♦	♦	✦		TXS-100-1	8T-20
	TPGT322C6	160308	•					♦	♦					TXS-100-1	8T-20
	TPGT322C6T	160308		•				♦	♦					TXS-100-1	8T-20
	TPGT3251C2	16T304	•							♦	♦	✦		TXS-100-1	8T-20
	TPGT3251C2T	16T304		•						♦	♦	✦		TXS-100-1	8T-20
	TPGT3251C6	16T304	•					♦	♦					TXS-100-1	8T-20
	TPGT3251C6T	16T304		•				♦	♦					TXS-100-1	8T-20
TPGT3252C2	16T308	•							♦	♦	✦		TXS-100-1	8T-20	
TPGT3252C2T	16T308		•						♦	♦	✦		TXS-100-1	8T-20	
TPGT3252C6	16T308	•					♦	♦					TXS-100-1	8T-20	
TPGT3252C6T	16T308		•				♦	♦					TXS-100-1	8T-20	
TPMT	TPMT3205CMFC03	160302		•					♦			✦	✦	TXS-100-1	8T-20
	TPMT321CMFC03	160304		•					♦			✦	✦	TXS-100-1	8T-20
	TPMT321CFEC03	160304		•			✦	✦				✦	✦	TXS-100-1	8T-20
	TPMT321CFEP01	160304		•			♦	♦	✦					TXS-100-1	8T-20
	TPMT322CFEC03	160308		•			✦	✦	♦			✦	✦	TXS-100-1	8T-20
	TPMT322CFEP01	160308		•			♦	♦	✦					TXS-100-1	8T-20

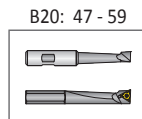
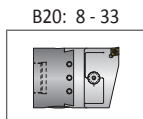
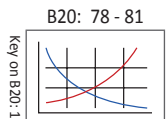

♦ = Recommended
✦ = Secondary

Inserts supplied in packs of 10
Screws sold in multiples of 10

A DRILLING
B BORING
C REAMING
D BURNISHING
E THREADING
X SPECIALS

Criterion Inserts



60° Triangle | TP••

TP••

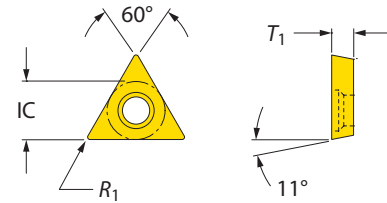
Imperial (in)			Metric (mm)			Part No.
IC	T ₁	R ₁	IC	T ₁	R ₁	
0.250	0.094	0.002	6.35	2.38	0.05	TP••2150...
0.250	0.094	0.016	6.35	2.38	0.40	TP••2151...
0.250	0.094	0.031	6.35	2.38	0.80	TP••2152...
0.375	0.125	0.016	9.53	3.18	0.40	TP••321...
0.375	0.125	0.031	9.53	3.18	0.80	TP••322...
0.375	0.156	0.016	9.53	3.97	0.40	TP••3251...
0.375	0.156	0.031	9.53	3.97	0.80	TP••3252...

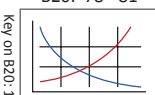

Part No.	ISO Description	Carbide		Cermet		CBN	P	M	K	N	S	H	Torx Screw	Torx Wrench
		Uncoated	Coated	Uncoated	Coated		Free Cutting	Carbon / Alloy	Stainless	Grey Cast Iron	Nodular Cast Iron	Non-ferrous		
TPGW2150C2	1102V5	•							◆	◆	◇		TXS-116-1	8T-7
TPGW2150C2T	1102V5		•						◆	◆	◇		TXS-116-1	8T-7
TPGW2150C6	1102V5	•					◆	◇					TXS-116-1	8T-7
TPGW2150C6T	1102V5		•				◆	◇					TXS-116-1	8T-7
TPGW2151C2	110204	•							◆	◆	◇		TXS-116-1	8T-7
TPGW2151C2T	110204		•						◆	◆	◇		TXS-116-1	8T-7
TPGW2151C6	110204	•					◆	◇					TXS-116-1	8T-7
TPGW2151C6T	110204		•				◆	◇					TXS-116-1	8T-7
TPGW2152C2	110208	•							◆	◆	◇		TXS-116-1	8T-7
TPGW2152C2T	110208		•						◆	◆	◇		TXS-116-1	8T-7
TPGW2152C6	110208	•					◆	◇					TXS-116-1	8T-7
TPGW2152C6T	110208		•				◆	◇					TXS-116-1	8T-7
TPGW320C2	1603V5	•							◆	◆	◇		TXS-100-1	8T-20
TPGW320C2T	1603V5		•						◆	◆	◇		TXS-100-1	8T-20
TPGW320C6	1603V5	•					◆	◇					TXS-100-1	8T-20
TPGW320C6T	1603V5		•				◆	◇					TXS-100-1	8T-20
TPGW321C2	160304	•							◆	◆	◇		TXS-100-1	8T-20
TPGW321C2T	160304		•						◆	◆	◇		TXS-100-1	8T-20
TPGW321C6	160304	•					◆	◇					TXS-100-1	8T-20
TPGW321C6T	160304		•				◆	◇					TXS-100-1	8T-20
TPGW322C2	160308	•							◆	◆	◇		TXS-100-1	8T-20
TPGW322C2T	160308		•						◆	◆	◇		TXS-100-1	8T-20
TPGW322C6	160308	•					◆	◇					TXS-100-1	8T-20
TPGW322C6T	160308		•				◆	◇					TXS-100-1	8T-20
TPGW3250C2	16T3V5	•							◆	◆	◇		TXS-100-1	8T-20
TPGW3250C2T	16T3V5		•						◆	◆	◇		TXS-100-1	8T-20
TPGW3250C6	16T3V5	•					◆	◇					TXS-100-1	8T-20
TPGW3250C6T	16T3V5		•				◆	◇					TXS-100-1	8T-20
TPGW3251C2	16T304	•							◆	◆	◇		TXS-100-1	8T-20
TPGW3251C2T	16T304		•						◆	◆	◇		TXS-100-1	8T-20
TPGW3251C6	16T304	•					◆	◇					TXS-100-1	8T-20
TPGW3251C6T	16T304		•				◆	◇					TXS-100-1	8T-20
TPGW3252C2	16T308	•							◆	◆	◇		TXS-100-1	8T-20
TPGW3252C2T	16T308		•						◆	◆	◇		TXS-100-1	8T-20
TPGW3252C6	16T308	•					◆	◇					TXS-100-1	8T-20
TPGW3252C6T	16T308		•				◆	◇					TXS-100-1	8T-20

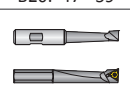
B20: 78 - 81  B20: 8 - 33  B20: 47 - 59 

key on B20: 1

◆ = Recommended
◇ = Secondary

Inserts supplied in packs of 10
Screws sold in multiples of 10

Criterion Inserts

80° Trigon | WC••

WC••

Imperial (in)			Metric (mm)			Part No.
IC	T ₁	R ₁	IC	T ₁	R ₁	
0.156	0.063	0.008	3.97	1.60	0.20	WC••020102...
0.156	0.063	0.016	3.97	1.60	0.40	WC••020104...

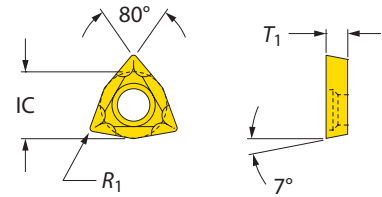

Part No.	ISO Description	Carbide		Cermet		CBN	P	M	K	N	S	H	Torx Screw	Torx Wrench
		Uncoated	Coated	Uncoated	Coated		Free Cutting	Carbon / Alloy	Stainless	Grey Cast Iron	Nodular Cast Iron	Non-ferrous		
WCMT	WCMT020102C2	020102	•					❖	❖	❖	♦		TXS-028-1	8T-6
	WCMT020102C2T	020102		•				♦	♦	♦	❖		TXS-028-1	8T-6
	WCMT020102C6	020102	•				❖	❖					TXS-028-1	8T-6
	WCMT020102C6T	020102		•			♦	♦					TXS-028-1	8T-6
	WCMT020104C2	020104	•					❖	❖	❖	♦		TXS-028-1	8T-6
	WCMT020104C2T	020104		•				♦	♦	♦	❖		TXS-028-1	8T-6
	WCMT020104C6	020104	•				❖	❖					TXS-028-1	8T-6
	WCMT020104C6T	020104		•			♦	♦					TXS-028-1	8T-6

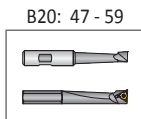
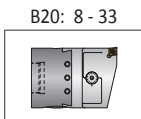
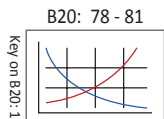

Key on B20-1

♦ = Recommended
❖ = Secondary

Inserts supplied in packs of 10
Screws sold in multiples of 10

Criterion Boring Kits

Micro Adjusting | CNC Kits

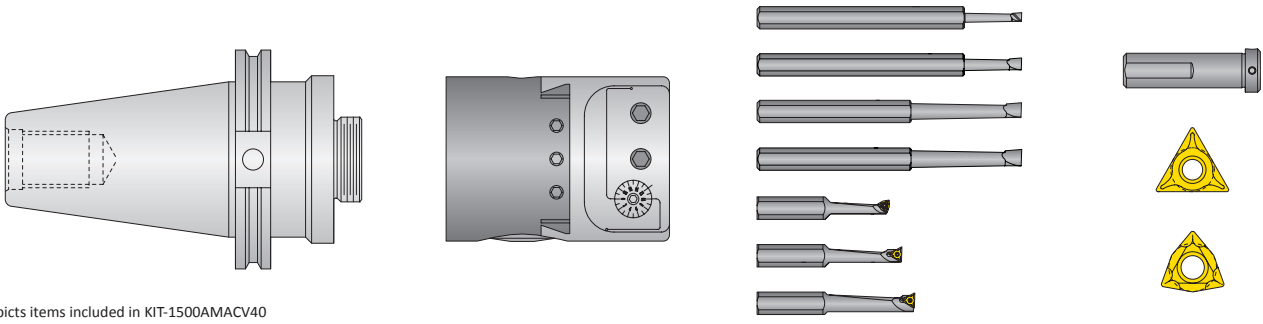

Image depicts items included in KIT-1500AMACV40

D_1 Range	Components Included in Kit					Part No.
	Boring Head	Shank	Boring Bars	Adapters	Inserts	
0.060 - 2.500	CB-1500AMA	CB1500-CV40	CBT-00600300G CBT-00800300G CBT-01000600G CBT-01100600G TA-02501062A TA-03121437A TA-03751750A	BTH-01250375	WCMT020102C6T TCMT12121CFGC04	KIT-1500AMACV40
0.060 - 2.500	CB-1500AMA	CB1500-CV50	CBT-00600300G CBT-00800300G CBT-01000600G CBT-01100600G TA-02501062A TA-03121437A TA-03751750A	BTH-01250375	WCMT020102C6T TCMT12121CFGC04	KIT-1500AMACV50
0.060 - 3.250	CB-2500BMA	CB2500-CV40	CBT-00600300G CBT-00800300G CBT-01000600G CBT-01100600G TA-02501062B TA-03121437B TA-03751750B TA-04372062B TA-05002187B	BTH-01250500	WCMT020102C6T TCMT12121CFGC04 TPGT2151C6T	KIT-2500BMACV40
0.060 - 3.250	CB-2500BMA	CB2500-CV50	CBT-00600300G CBT-00800300G CBT-01000600G CBT-01100600G TA-02501062B TA-03121437B TA-03751750B TA-04372062B TA-05002187B	BTH-01250500	WCMT020102C6T TCMT12121CFGC04 TPGT2151C6T	KIT-2500BMACV50

i

i = Imperial (in)
m = Metric (mm)

A DRILLING
B BORING
C REAMING
D BURNISHING
E THREADING
X SPECIALS



Criterion Boring Kits

Micro Adjusting | CNC Kits

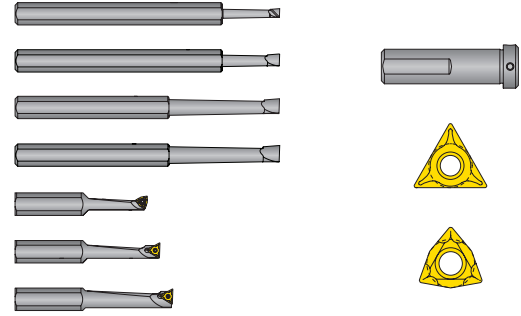
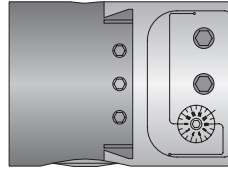
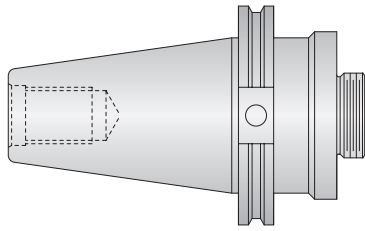

Image depicts items included in KIT-1500AMACV40

	Components Included in Kit						
	D_1 Range	Boring Head	Shank	Boring Bars	Adapters	Inserts	Part No.
	0.120 - 5.125	CB-3000DMA	CB3000-CV40	CBT-01200500H CBT-01400625H CBT-01600750H CBT-01800875H TA-02501062B TA-03121437B TA-03751750B TA-04372062B TA-05002500D TA-07503000D TA-10003500D TA-12504000D	BTH-02500750 BTH-05000750	WCMT020102C6T TCMT12121CFGC04 TPGT2151C6T TPGT321C6T	KIT-3000DMACV40
i	0.120 - 5.125	CB-3000DMA	CB3000-CV50	CBT-01200500H CBT-01400625H CBT-01600750H CBT-01800875H TA-02501062B TA-03121437B TA-03751750B TA-04372062B TA-05002500D TA-07503000D TA-10003500D TA-12504000D	BTH-02500750 BTH-05000750	WCMT020102C6T TCMT12121CFGC04 TPGT2151C6T TPGT321C6T	KIT-3000DMACV50

i = Imperial (in)
m = Metric (mm)

Criterion Boring Kits

CB Style | Balance Kits

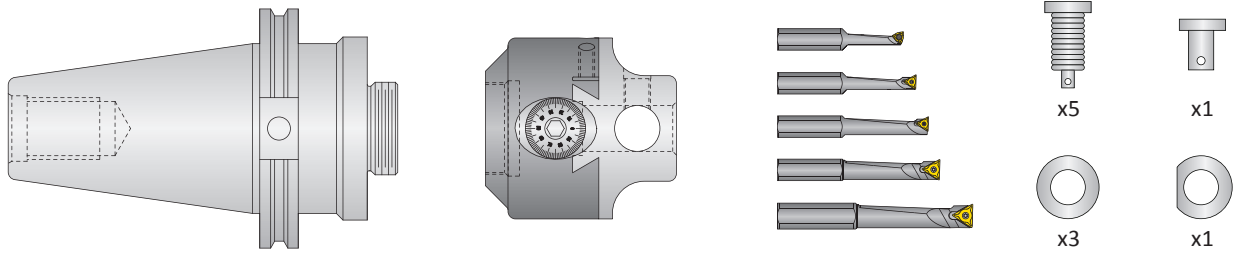

Image depicts items included in KIT-202BCV40BAL

	Components Included in Kit			Part No.	
	D ₁ Range	Boring Head	Boring Bars		Shank
i	0.250 - 2.500	—	—	—	KIT-202BBAL
	0.250 - 2.500	Kits include: • CB-202B	Kits include: • TA-02501062B • TA-03121437B • TA-03751750B • TA-04372062B • TA-05002187B	—	KIT-202BTABAL
				R8-087520	KIT-202BR8BAL
				NMBT40-087520	KIT-202BNT40BAL
				CB2000-CV40	KIT-202BCV40BAL
				CB2000-BT40	KIT-202BBT40BAL
				CB2000-HSK63A	KIT-202BHS63BAL
m	6 - 76	—	—	—	KIT-050MBBAL
	6 - 76	Kits include: • CB-050MB	Kits include: • TA-06M027B • TA-08M036B • TA-10M045B • TA-12M054B	—	KIT-050MBTABAL
				CB050M-DIN40	KIT-050MBD40BAL
				CB050M-ISO40	KIT-050MBI40BAL

NOTE: To obtain balance, all kits include 6 shafts and 4 weights

Notes:

- Bores up to 8x faster
- Fits all 202B style boring heads
- Improves bore finish, concentricity, and productivity
- Simple and easy to use
- U.S. Patent No.: 7,309,194

D BURNISHING

F THREADING

X SPECIALS

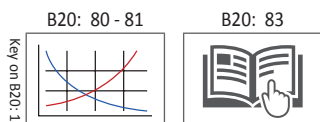

i = Imperial (in)
m = Metric (mm)
Inserts sold separately



Cri-Tip Boring Heads - Competitor Connection Kits

CB Style | Balance Kits

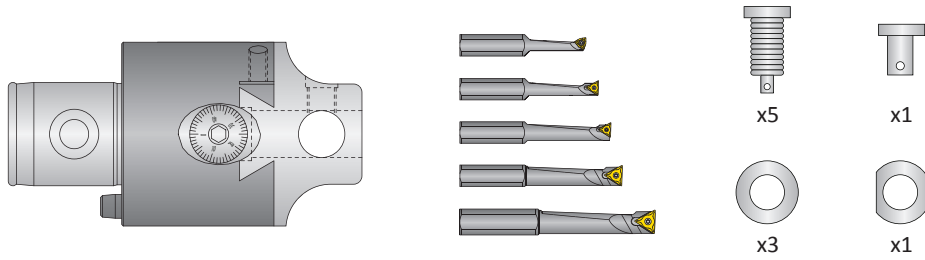

Big® Kaiser®

	Components Included in Kit			
	D_1 Range	Boring Head	Boring Bars	Part No.
i	0.250 - 2.500	CTP2000-K5202B	TA-02501062B TA-03121437B TA-03751750B TA-04372062B TA-05002187B	KIT-CTP202K5BAL

NOTE: To obtain balance, all kits include 6 shafts and 4 weights

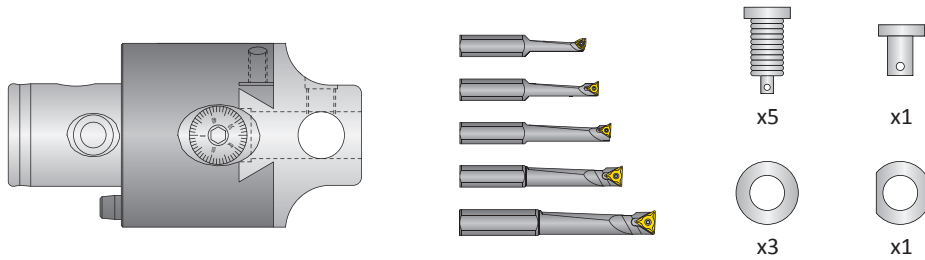

Komet® ABS®

	Components Included in Kit			
	D_1 Range	Boring Head	Boring Bars	Part No.
i	0.250 - 2.500	CTP2000-A50202B	TA-02501062B TA-03121437B TA-03751750B TA-04372062B TA-05002187B	KIT-CTP202A5BAL

NOTE: To obtain balance, all kits include 6 shafts and 4 weights

B20: 80 - 81

B20: 83

Key on B20-1

i = Imperial (in)
m = Metric (mm)
Inserts sold separately

Criterion Boring Kits

CB Style | Carbide Boring Bars

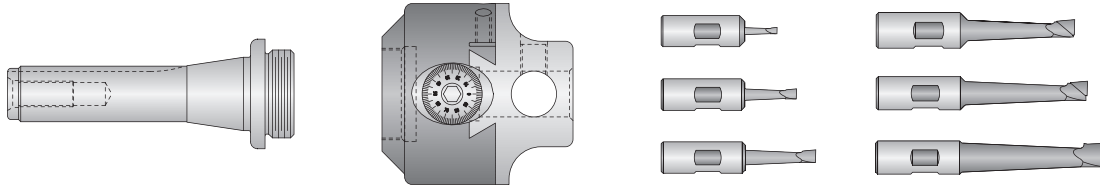
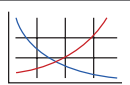



Image depicts items included in KIT-202BR8SBT

	Components Included in Kit					Part No.
	D ₁ Range	Boring Head	Shank	Boring Bars	Adapters	
	0.125 - 2.500	CB-202B	R8-087520	SBT-01250500B SBT-01870812B SBT-02501125B SBT-03121500B SBT-03751750B SBT-05002187B	-	KIT-202BR8SBT
	0.500 - 5.125	CB-203D	R8-150018	SBT-05002187D SBT-06252750D SBT-07503000D SBT-10003500D SBT-12504000D	-	KIT-203DR8SBT
i	0.125 - 5.125	CB-203D	R8-150018	SBT-01250500B SBT-01870812B SBT-02501125B SBT-03121500B SBT-03751750B SBT-05002187B SBT-06252750D SBT-07503000D SBT-10003500D SBT-12504000D	BTH-05000750	KIT-203DR8SBTBD
	3 - 62	CB-038MA	-	SBT-03012MA SBT-04020MA SBT-06028MA SBT-08037MA SBT-10048MA SBT-12055MA	-	KIT-CB038MASBT
m	0.05 - 76	CB-050MB	-	SBT-03012MB SBT-04020MB SBT-06028MB SBT-08037MB SBT-10048MB SBT-12055MB	CHB-012M	KIT-CB050MBSBT
	12 - 130	CB-076MD	-	SBT-12063MD SBT-16071MD SBT-19078MD SBT-25090MD SBT-32100MD	CHB-020M	KIT-CB076MDSBT

B20: 80 - 81  Key on B20: 1

B20: 83 

i = Imperial (in)
m = Metric (mm)

A DRILLING
B BORING
C REAMING
D BURNISHING
E THREADING
X SPECIALS



Criterion Boring Kits

CB Style | TA Insert Boring Bars

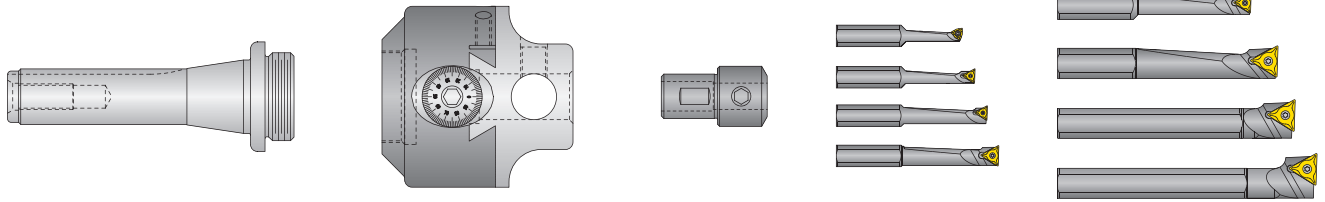
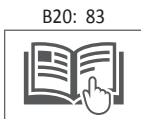
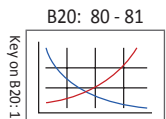

Image depicts items included in KIT-203DR8TABD

	Components Included in Kit					Part No.
	D ₁ Range	Boring Head	Shank	Boring Bars	Adapters	
	0.250 - 2.500	CB-202B	R8-087520	TA-02501062B TA-03121437B TA-03751750B TA-04372062B TA-05002187B	-	KIT-202BR8TA
	0.500 - 5.125	CB-203D	R8-150018	TA-05002500D TA-07503000D TA-10003500D TA-12504000D	-	KIT-203DR8TA
i	0.250 - 5.125	CB-203D	R8-150018	TA-02501062B TA-03121437B TA-03751750B TA-04372062B TA-05002500D TA-07503000D TA-10003500D TA-12504000D	BTH-05000750	KIT-203DR8TABD
	0.250 - 5.125	CB-203D	CB3000-CV40	TA-02501062B TA-03121437B TA-03751750B TA-04372062B TA-05002500D TA-07503000D TA-10003500D TA-12504000D	BTH-05000750	KIT-203DC40TABD
	6 - 62	CB-038MA	-	TA-06M027A TA-08M036A TA-10M045A	-	KIT-CB038MATA
	6 - 62	CB-038MA	-	TAS-06M012A TAS-08M016A TAS-10M020A	-	KIT-CB038MATAS
	6 - 76	CB-050MB	-	TA-06M027B TA-08M036B TA-10M045B TA-12M054B	CHB-012M	KIT-CB050MBTA
m	6 - 76	CB-050MB	-	TAS-06M012B TAS-08M016B TAS-10M020B TAS-12M024B	CHB-012M	KIT-CB050MBTAS
	10 - 130	CB-076MD	-	TA-10M045D TA-12M054D TA-16M072D TA-20M090D	CHB-020M	KIT-CB076MDTA
	10 - 130	CB-076MD	-	TAS-10M020D TAS-12M024D TAS-16M032D TAS-20M040D	CHB-020M	KIT-CB076MDTAS



i = Imperial (in)
m = Metric (mm)
Inserts sold separately

Criterion Boring Bar Sets

Carbide | Round Shank | Imperial

A
DRILLING

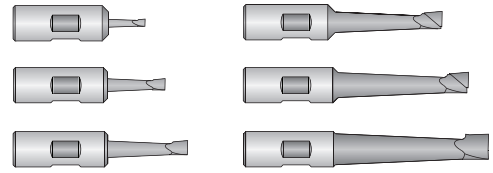

Image depicts items included in SET-SBTB

B
BORING

D_2	Boring Bars Included in Set	Part No.
0.375	SBT-01250500A SBT-01870812A SBT-02501125A SBT-03121500A SBT-03751875A SBT-05002312A	SET-SBTA
0.500	SBT-01250500B SBT-01870812B SBT-02501125B SBT-03121500B SBT-03751750B SBT-05002187B	SET-SBTB
0.750	SBT-05002187D SBT-06252750D SBT-07503000D SBT-10003500D SBT-12504000D	SET-SBTD
1.000	SBT-05002375E SBT-06252625E SBT-07502875E SBT-10003500E SBT-12503875E	SET-SBTE

C
REAMING

D
BURNISHING

F
THREADING

X
SPECIALS

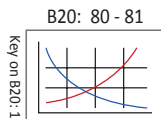

i = Imperial (in)
m = Metric (mm)

Criterion Boring Bar Sets

Carbide | Round Shank | Stubby

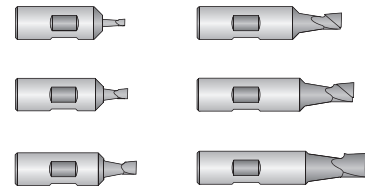
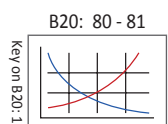

Image depicts items included in SET-SBTBSHT

	D_2	Boring Bars Included in Set	Part No.
i	0.500	SBT-01250250B SBT-01870312B SBT-02500437B SBT-03120562B SBT-03750687B SBT-05000812B	SET-SBTBSHT
	0.750	SBT-05001312D SBT-07501531D SBT-10001750D	SET-SBTDSHT



i = Imperial (in)
m = Metric (mm)

A **Criterion Boring Bar Sets**

Carbide | Square Shank

DRILLING

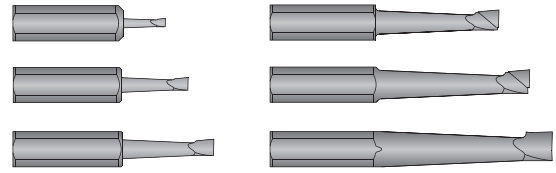

Image depicts items included in SET-SBTBS

B

BORING

	D_2	Boring Bars Included in Set	Part No.
i	0.500	SBT-01250500BS SBT-01870812BS SBT-02501125BS SBT-03121500BS SBT-03751750BS SBT-05002187BS	SET-SBTBS

C

REAMING

	10	SBT-03012MA SBT-04020MA SBT-06028MA SBT-08037MA SBT-10048MA SBT-12055MA	SET-SBTMA
--	----	--	------------------

D

BURNISHING

m	12	SBT-03012MB SBT-04020MB SBT-06028MB SBT-08037MB SBT-10048MB SBT-12055MB	SET-SBTMB
	20	SBT-12063MD SBT-16071MD SBT-19078MD SBT-25090MD SBT-32100MD	SET-SBTMD
	25	SBT-12060ME SBT-16067ME SBT-19047ME SBT-25089ME SBT-32100ME	SET-SBTME

F

THREADING

X

SPECIALS

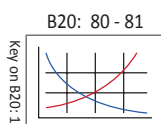

i = Imperial (in)
m = Metric (mm)



Criterion Boring Bar Sets

TA Insert

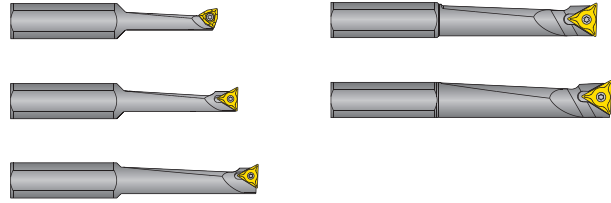
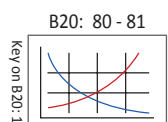

Image depicts items included in SET-TAB

	D_2	Boring Bars Included in Set	Part No.
i	0.500	TA-02501062B TA-03121437B TA-03751750B TA-04372062B TA-05002187B	SET-TAB
	0.750	TA-05002500D TA-07503000D TA-10003500D TA-12504000D	SET-TAD
	1.000	TA-05002375E TA-07502875E TA-10003500E TA-12503875E	SET-TAE
m	10	TA-06M027A TA-08M036A TA-10M045A	SET-TAMA
	10	TAS-06M012A TAS-08M016A TAS-10M020A	SET-TASMA
	12	TA-06M027B TA-08M036B TA-10M045B TA-12M054B	SET-TAMB
	12	TAS-06M012B TAS-08M016B TAS-10M020B TAS-12M024B	SET-TASMB
	20	TA-10M045D TA-12M054D TA-16M072D TA-20M090D	SET-TAMD
	20	TAS-10M020D TAS-12M024D TAS-16M032D TAS-20M040D	SET-TASMD
	25	TA-10M045E TA-12M054E TA-16M072E TA-20M090E TA-25M113E	SET-TAME
	25	TAS-10M020E TAS-12M024E TAS-16M032E TAS-20M040E TAS-25M050E	SET-TASME



i = Imperial (in)
m = Metric (mm)
Inserts sold separately

Recommended Cutting Data | Imperial (inch)

Rough Boring

ISO	Material	Hardness (BHN)	Cri-Twin®		Feed (IPR)
			SFM		
			Uncoated Inserts	Coated Inserts	
P	Free Machining Steel 1118, 1215, 12L14, etc.	100 - 250	450 - 800	450 - 1000	0.006 - 0.016
	Low Carbon Steel 1010, 1020, 1025, 1522, 1144, etc.	85 - 275	450 - 800	450 - 1000	0.006 - 0.016
	Medium Carbon Steel 1030, 1040, 1050, 1527, 1140, 1151, etc.	125 - 325	450 - 800	450 - 1000	0.006 - 0.016
	Alloy Steel 4140, 5140, 8640, etc.	125 - 375	450 - 800	450 - 1000	0.006 - 0.016
	High Strength Alloy 4340, 4330V, 300M, etc.	225 - 400	400 - 700	450 - 800	0.006 - 0.016
	Tool Steel H-13, H-21, A-4, O-2, 5-3, etc.	150 - 250	400 - 700	400 - 700	0.006 - 0.010
S	High Temp Alloy Hastelloy B, Inconel 600, etc.	140 - 310	100 - 250	150 - 300	0.006 - 0.010
M	Stainless Steel 400 Series 1010, 1020, 1025, 1522, 1144, etc.	185 - 350	400 - 600	400 - 700	0.006 - 0.012
	Stainless Steel 300 Series 1010, 1020, 1025, 1522, 1144, etc.	135 - 275	400 - 600	400 - 700	0.006 - 0.012
	Super Duplex Stainless Steel 1010, 1020, 1025, 1522, 1144, etc.	135 - 275	400 - 600	400 - 700	0.006 - 0.012
K	Nodular, Grey, Ductile Cast Iron	120 - 320	400 - 600	500 - 700	0.006 - 0.012
N	Cast Aluminum	30 - 180	750 - 1000	800 - 1100	0.006 - 0.016
	Wrought Aluminum	30 - 180	750 - 1000	750 - 1000	0.006 - 0.016
	Brass	100	700 - 950	750 - 1000	0.006 - 0.016

See page B20: 82 for instructions on applying the Cri-Twin boring head in different applications

NOTICE: The modular boring system's configuration, including the length of boring bar, boring head off set, and amount of extensions and/or reducers, may all affect performance of boring systems. All of these factors may increase imbalance of the modular boring system. Imbalance at excessive RPM will cause vibration in the machine tool, which can cause damage to the machine tool; in particular the spindle. This vibration may occur at spindle speeds above 1000 RPM. If vibration is present, reduce spindle speed.

Recommended Cutting Data | Metric (mm)

Rough Boring

ISO	Material	Hardness (BHN)	Cri-Twin®		Feed (mm/rev)
			M/min		
			Uncoated Inserts	Coated Inserts	
P	Free Machining Steel 1118, 1215, 12L14, etc.	100 - 250	137 - 244	137 - 305	0.15 - 0.41
	Low Carbon Steel 1010, 1020, 1025, 1522, 1144, etc.	85 - 275	137 - 244	137 - 305	0.15 - 0.41
	Medium Carbon Steel 1030, 1040, 1050, 1527, 1140, 1151, etc.	125 - 325	137 - 244	137 - 305	0.15 - 0.41
	Alloy Steel 4140, 5140, 8640, etc.	125 - 325	137 - 244	137 - 305	0.15 - 0.41
	High Strength Alloy 4340, 4330V, 300M, etc.	225 - 400	122 - 213	137 - 244	0.15 - 0.41
	Tool Steel H-13, H-21, A-4, O-2, 5-3, etc.	150 - 250	122 - 213	122 - 213	0.15 - 0.25
S	High Temp Alloy Hastelloy B, Inconel 600, etc.	140 - 310	30 - 76	46 - 91	0.15 - 0.25
M	Stainless Steel 400 Series 1010, 1020, 1025, 1522, 1144, etc.	185 - 350	122 - 182	122 - 213	0.15 - 0.31
	Stainless Steel 300 Series 1010, 1020, 1025, 1522, 1144, etc.	135 - 275	122 - 182	122 - 213	0.15 - 0.31
	Super Duplex Stainless Steel 1010, 1020, 1025, 1522, 1144, etc.	135 - 275	122 - 182	122 - 213	0.15 - 0.31
K	Nodular, Grey, Ductile Cast Iron	120 - 320	122 - 182	152 - 213	0.15 - 0.31
N	Cast Aluminum	30 - 180	220 - 305	244 - 335	0.15 - 0.41
	Wrought Aluminum	30 - 180	220 - 305	229 - 305	0.15 - 0.41
	Brass	100	213 - 290	229 - 305	0.15 - 0.41

See page B20: 82 for instructions on applying the Cri-Twin boring head in different applications

NOTICE: The modular boring system's configuration, including the length of boring bar, boring head off set, and amount of extensions and/or reducers, may all affect performance of boring systems. All of these factors may increase imbalance of the modular boring system. Imbalance at excessive RPM will cause vibration in the machine tool, which can cause damage to the machine tool; in particular the spindle. This vibration may occur at spindle speeds above 1000 RPM. If vibration is present, reduce spindle speed.

Recommended Cutting Data | Imperial (inch)

Finish Boring

ISO	Material	Hardness (BHN)	Cri-Bore® CBER® CB Style		
			SFM		Feed (IPR)
			Uncoated Inserts	Coated Inserts	
P	Free Machining Steel 1118, 1215, 12L14, etc.	100 - 250	350 - 700	450 - 800	0.003 - 0.005
	Low Carbon Steel 1010, 1020, 1025, 1522, 1144, etc.	85 - 275	350 - 700	450 - 800	0.002 - 0.004
	Medium Carbon Steel 1030, 1040, 1050, 1527, 1140, 1151, etc.	125 - 325	400 - 700	500 - 800	0.002 - 0.004
	Alloy Steel 4140, 5140, 8640, etc.	125 - 375	300 - 600	400 - 700	0.002 - 0.004
	High Strength Alloy 4340, 4330V, 300M, etc.	225 - 400	300 - 600	350 - 650	0.002 - 0.004
	Tool Steel H-13, H-21, A-4, O-2, 5-3, etc.	150 - 250	300 - 600	300 - 700	0.002 - 0.004
S	High Temp Alloy Hastelloy B, Inconel 600, etc.	140 - 310	100 - 250	150 - 300	0.002 - 0.004
M	Stainless Steel 400 Series 1010, 1020, 1025, 1522, 1144, etc.	185 - 350	350 - 600	400 - 650	0.002 - 0.004
	Stainless Steel 300 Series 1010, 1020, 1025, 1522, 1144, etc.	135 - 275	350 - 600	400 - 650	0.002 - 0.004
	Super Duplex Stainless Steel 1010, 1020, 1025, 1522, 1144, etc.	135 - 275	350 - 600	400 - 650	0.002 - 0.004
K	Nodular, Grey, Ductile Cast Iron	120 - 320	400 - 600	500 - 700	0.002 - 0.004
N	Cast Aluminum	30 - 180	750 - 1000	800 - 1100	0.002 - 0.004
	Wrought Aluminum	30 - 180	750 - 1000	750 - 1000	0.002 - 0.004
	Brass	100	700 - 950	750 - 1000	0.002 - 0.004

NOTICE: The modular boring system's configuration, including the length of boring bar, boring head off set, and amount of extensions and/or reducers, may all affect performance of boring systems. All of these factors may increase imbalance of the modular boring system. Imbalance at excessive RPM will cause vibration in the machine tool, which can cause damage to the machine tool; in particular the spindle. This vibration may occur at spindle speeds above 1000 RPM. If vibration is present, reduce spindle speed.

Recommended Cutting Data | Metric (mm)

Finish Boring

ISO	Material	Hardness (BHN)	Cri-Bore® CBER® CB Style		Feed (mm/rev)
			M/min		
			Uncoated Inserts	Coated Inserts	
P	Free Machining Steel 1118, 1215, 12L14, etc.	100 - 250	107 - 213	137 - 244	0.08 - 0.13
	Low Carbon Steel 1010, 1020, 1025, 1522, 1144, etc.	85 - 275	107 - 213	137 - 244	0.05 - 0.10
	Medium Carbon Steel 1030, 1040, 1050, 1527, 1140, 1151, etc.	125 - 325	122 - 213	152 - 244	0.05 - 0.10
	Alloy Steel 4140, 5140, 8640, etc.	125 - 325	91 - 182	122 - 213	0.05 - 0.10
	High Strength Alloy 4340, 4330V, 300M, etc.	225 - 400	91 - 182	107 - 198	0.05 - 0.10
	Tool Steel H-13, H-21, A-4, O-2, 5-3, etc.	150 - 250	91 - 182	107 - 213	0.05 - 0.10
S	High Temp Alloy Hastelloy B, Inconel 600, etc.	140 - 310	30 - 76	46 - 91	0.05 - 0.10
M	Stainless Steel 400 Series 1010, 1020, 1025, 1522, 1144, etc.	185 - 350	107 - 182	122 - 198	0.05 - 0.10
	Stainless Steel 300 Series 1010, 1020, 1025, 1522, 1144, etc.	135 - 275	107 - 182	122 - 198	0.05 - 0.10
	Super Duplex Stainless Steel 1010, 1020, 1025, 1522, 1144, etc.	135 - 275	107 - 182	122 - 198	0.05 - 0.10
K	Nodular, Grey, Ductile Cast Iron	120 - 320	122 - 182	152 - 213	0.05 - 0.10
N	Cast Aluminum	30 - 180	229 - 305	244 - 335	0.05 - 0.10
	Wrought Aluminum	30 - 180	229 - 305	229 - 305	0.05 - 0.10
	Brass	100	213 - 290	229 - 305	0.05 - 0.10

NOTICE: The modular boring system's configuration, including the length of boring bar, boring head off set, and amount of extensions and/or reducers, may all affect performance of boring systems. All of these factors may increase imbalance of the modular boring system. Imbalance at excessive RPM will cause vibration in the machine tool, which can cause damage to the machine tool; in particular the spindle. This vibration may occur at spindle speeds above 1000 RPM. If vibration is present, reduce spindle speed.

Set-up Instructions | Cri-Twin® Modular Boring Heads

Adjusting Cri-Twin Modular Boring Heads (see figure B1)

1. Loosen the insert holder locking screw (4) on the insert holder (1) to be adjusted. Re-snug lightly using light finger pressure only. Only one insert holder should be adjusted at a time. The other insert holder should remain locked.
2. Loosen and re-snug the body clamp bolt (5) so a small amount of tension is felt when adjusting the dial screw.
3. Turn the dial screw (3) clockwise to increase the diameter and counterclockwise to decrease the diameter.
4. Tighten the insert holder locking screw (4).
5. Rotate the boring head 180°.
6. Repeat steps 1, 3, and 4.
7. Tighten the body clamp bolt (5).

NOTE: To machine a smaller bore diameter, turn the dial screw (3) counterclockwise one full turn minimum to remove any backlash, and then adjust to small size.

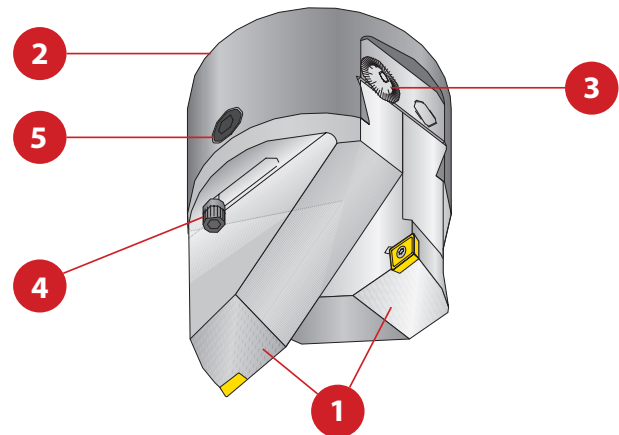

Figure B1

No.	Part
1	Insert holders
2	Boring head body
3	Dial screw
4	Insert holder locking screw
5	Body clamp bolt

Cri-Twin Modular Boring Heads

The Cri-Twin Modular Boring System is one of the most versatile boring systems available today. With a combination of insert holders, you can perform different types of boring operations. The Cri-Twin system can double your feed rate, double the material removed, or rough and finish in the same operation.

1. Double Feed Rate Operations:

This requires using two "standard length" or two "zero lead" insert holders and setting the cutting tips of both insert holders to bore the same diameter. The inserts will make equal cuts in the bore so you can double your feed rate and reduce the cycle time to bore your hole. Utilizing the Cri-Twin system in this manner may leave tool retraction marks in the finish bore. For best results, you should bore into and out of the hole.

NOTICE: Use rough boring feed recommendations from charts on pages B20: 78 - 79.

2. Double Material Removed:

This requires using a standard and a short length insert holder. The standard length insert holder enters the cut first so it needs to be set to remove one-half of the material to be bored from the hole. The short insert holder is then set to the finish bore diameter. Remember, when doubling the material removed, each cutting edge is working separately, and you should not double your feed rate.

NOTICE: Use finish boring feed recommendations from charts on pages B20: 80 - 81.

3. Roughing and Finishing:

This requires using a standard and a short length insert holder. The standard length insert holder will be set to the rough bore diameter and then the short length insert holder will be set to the finish bore diameter. Utilizing the Cri-Twin system in this manner may leave tool retraction marks in the finish bore. For best results, you should bore into and out of the hole.

NOTICE: Use finish boring feed recommendations from charts on pages B20: 80 - 81.

Set-up Instructions | Standard and Micro Adjusting Boring Heads**Adjusting Standard Adjusting Boring Heads (see figure B2)**

1. Loosen the locking screw (6).
2. Turn the dial screw (3) clockwise to increase the diameter, and turn it counterclockwise to decrease the diameter.
3. Tighten the locking screw (6).

IMPORTANT: Do not loosen the gib screws (5). It can cause poor performance when making diameter adjustments.

NOTE: To machine a smaller bore diameter, turn the dial screw (3) counterclockwise one full turn minimum to remove any backlash, and then adjust to small size.

No.	Part
1	Bar holder
2	Boring head body
3	Dial screw
4	Bar holder set screws
5	Gib screws
6	Locking screw

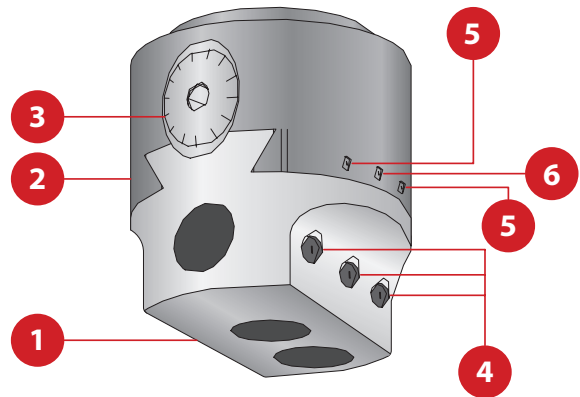

Figure B2

Adjusting Micro Adjusting Setting Boring Heads (see figure B3)

Before setting the micro adjusting boring head to the bore diameter, you need to set the micro adjusting dial (7) to the minimum bore diameter.

1. Turn the micro adjusting dial (7) clockwise until the dial screw bottoms out on the bottom of the dial screw bore.
2. Note the graduation line on the dial face closest to the reference line, then turn the micro adjusting dial (7) counterclockwise 3-1/4 turns.
3. Reverse direction and line the graduation line noted in Step 2 with the reference line.
4. The micro adjusting dial is now set so you have 0.006" on diameter of adjustment.

Adjusting micro adjusting setting boring heads is just as easy as adjusting standard boring heads. First, you adjust the boring head using the 0.001" adjustment (3), and then you make your final adjustment with the 0.00005" adjustment (7).

1. Loosen the locking screw (6).
2. Turn the dial screw (3) clockwise to increase the diameter and counterclockwise to decrease the diameter.
3. Tighten the locking screw (6).
4. Turn the 0.00005" dial screw (7) clockwise to increase the diameter and counterclockwise to decrease the diameter. Locking of the 0.00005" dial screw (7) is **not** required.

NOTE: The micro adjusting dial screws only have a total range of 0.006" (0.15mm) on diameter.

No.	Part
1	Insert holder
2	Boring head body
3	Dial screw
4	Gib screws
5	Locking screw
6	Micro adjusting dial screw

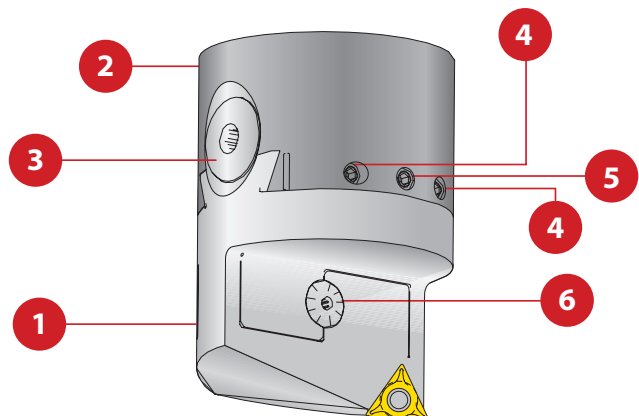

Figure B3

Set-up Instructions | Manual Boring and Facing Heads

For General Boring (see figure B4)

When no lateral movement is required, the Manual Boring and Facing head can be used for standard boring operations. Adjustments are made by placing a hex wrench in the end of the dial screw (6) and dialing off the required amount. Each graduation on the dial represents 0.001" on the bore diameter.

1. Loosen the locking screw (10).
2. Turn the dial screw (6) clockwise to increase the diameter and counterclockwise to decrease the diameter.
3. Tighten the locking screw (10).
4. To readjust for the next cut, repeat steps 1, 2, and 3.

NOTE: To machine a smaller bore diameter, turn dial screw (6) counterclockwise one full turn minimum to remove any backlash and then adjust to smaller size.

For Facing in the Reverse Direction

The Manual Boring & Facing Head is capable of reverse feed by running the spindle in reverse. To set the head for feeding in clockwise and counterclockwise direction, screw the head on the desired shank.

1. Align the "Rev. Lock" mark on the facing ring (7) with the "Rev. Lock" mark on the body (5) (see Figure B5).
2. Insert a 3/32" hex wrench through the hole in the facing ring (7) and tighten the reversing lock screw (15) (see Figure B6) in the top cap (14). This prevents the head from unscrewing during reverse (counterclockwise) operation.

NOTICE: To run the spindle in reverse, the head must be locked onto the shank. Please follow the directions above carefully.

For Facing, Grooving, and Undercutting

Set-up instructions:

1. Make sure the dial screw lock (12) is loose.
2. Insert a hex wrench in the dial screw (6) and position the tool at the start of the cut. To simplify a return to this position, set left* dog stop (2) against the stop pin (3).
3. Determine the length of cut required and with the aid of a gauge block, set the right* dog stop (4) against the stop pin (3).
4. Remove gauge block and lower the spindle to the proper depth.
5. Tighten the locking screw (12).
6. As the spindle turns, hold on to the facing ring (7). The tool will feed out at the rate of 0.003 per revolution (fine feed, 0.0015) until the right* dog stop (4) strikes the stop pin. At this point, the clutch will disengage. Although the facing ring (7) will continue to revolve, the tool will not advance.
7. For fine adjustments: after setting for facing mode with gauge block, the fine adjusting screws (13) may be utilized to aid in the adjustment of the dog stops (2) and (4).
8. To return the tool to the starting position, place a hex wrench in the dial screw (6) and turn counterclockwise until left* dog stop (2) contacts the stop pin (3) or (see note below) while holding onto the facing ring (7), reverse the spindle and the tool will go back to the starting position.

NOTICE: While machining either right or left hand, the bar holder (1) should never extend past the body (5) on the dial screw face side. This would result in tool damage due to the boring head rubbing inside of the bored hole.

* Instructions are based on right hand cutting. If the application requires left hand cutting, reverse the dog stop instructions listed above.

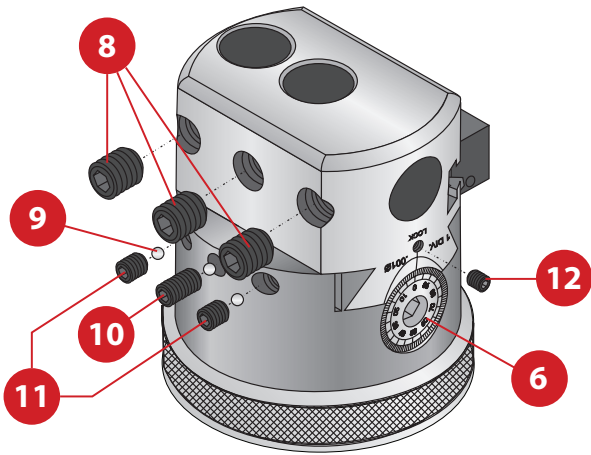

Figure B4

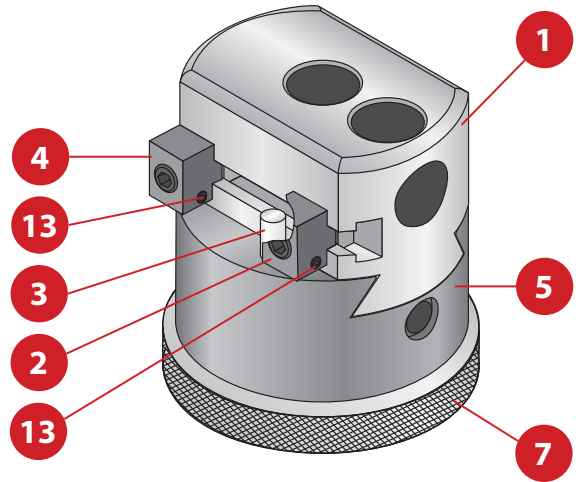

Figure B5

No.	Part	No.	Part
1	Bar holder	9	Steel balls
2	Left dog stop	10	Locking screw
3	Stop pin	11	Gib screws
4	Right dog stop	12	Dial screw lock
5	Body	13	Fine adjusting screws
6	Dial screw	14	Top cap
7	Facing ring	15	Reversing lock screw
8	Bar holder set screws		

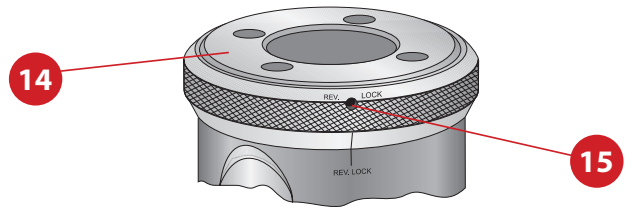

Figure B6

Set-up Instructions | CNC Boring and Facing Heads

For CNC Operations - Horizontal or Vertical

To set the head for CNC tool change operations, first refer to the "For Facing, Grooving, and Undercutting" and "For Facing in the Reverse Direction" instructions on page B20: 84 and set the gib, stop dogs, and thread lock as described.

1. Install the head in the machine spindle and ensure the spindle is in its "home" or "tool change" position. Take note of the position of the anti-rotation device on your machine in relation to the key slot in the taper shank. Then remove the head from the machine.
2. Using the two #10-32 cap screws supplied, attach the plunger housing (16) to the facing ring (7). Note that the lock ring (18) should be loose and turn freely.
3. Align the 1/8" dowel pin in the plunger (17) with the slot in the lock ring (18).
4. Attach the stop arm (19) to the plunger (17) using the #10-32 button head screw provided. At this time, the facing ring (7) should turn with slight resistance.
5. Rotate the facing ring (7) so that the stop arm (19) is in the approximate position relative to the key slot in the taper shank.
6. Install the head in the spindle, taking care to set the stop arm (19) in its proper position relative to the anti-rotation device on the machine.
7. With the head in the machine's spindle at its "home" or "tool change" position, clamp the lock ring clamps (20) in position using the two #4-40 set screws on the periphery of the lock ring (18). The head is now ready for use.

IMPORTANT: Stop arm is required.

Calculating Dwell Time: $T = (D / 0.0015) / (RPM / 60)$

Where:

- RPM = spindle speed
- 60 = seconds
- D = distance from the dog stop to the stop pin
- 0.0015 = radial feed per revolution (inches)
- T = dwell time (seconds)

Example:

The cut is 0.500" change in diameter. The radial distance (the distance the dog stop is away from the stop pin) is 0.250". This is your D. The spindle speed is determined to be 500 RPM. Therefore, the formula is now:

$$T = (0.250 / 0.0015) / (500 / 60)$$

$$T = 20 \text{ seconds}$$

NOTICE: Damage to the Boring & Facing head's clutch and gear mechanism may result if operated above 700 RPM. Because the head is not connected to, or controlled by, the machine's CNC control, allowances must be made in the machine's program to allow the head enough time to make its cut (and return). To accomplish this, a dwell must be inserted in the program. To calculate the dwell time, use the following formula.

As a matter of practice, the dwell time will almost always be a few seconds longer than "T" to allow the head to come firmly against the stop and force the clutch to slip. This will allow the tool to come to a constant size (spring cut). This may take some test cuts to determine the necessary additional time.

Use the information above to face a bottom bore and cut an internal relief groove. Call up the head in the CNC program. **DO NOT START THE SPINDLE.** Center the head over the bore to enter. Enter the holder in Z axis so that the groove tool is properly placed to begin cutting. In the program, set the RPM to be 500 as calculated from example. **NOW START THE SPINDLE** and set a dwell time of 22 seconds. At the end of this dwell, stop the spindle and set another dwell time of 22 seconds. At the end of this dwell, stop the spindle and retract the head. You now have a faced surface with an undercut.

If the tool is free of cutting on the return stroke, the head may be increased to the maximum of 700 RPM to speed the return as long as the dwell time is reduced accordingly so as not to slip the clutch unnecessarily. Excessive dwell time has the effect of "impact hammering" the feed mechanism against the dog stop and should be avoided.

No.	Part
7	Facing ring
16	Plunger housing
17	Plunger
18	Lock ring
19	Stop arm
20	Lock ring clamps

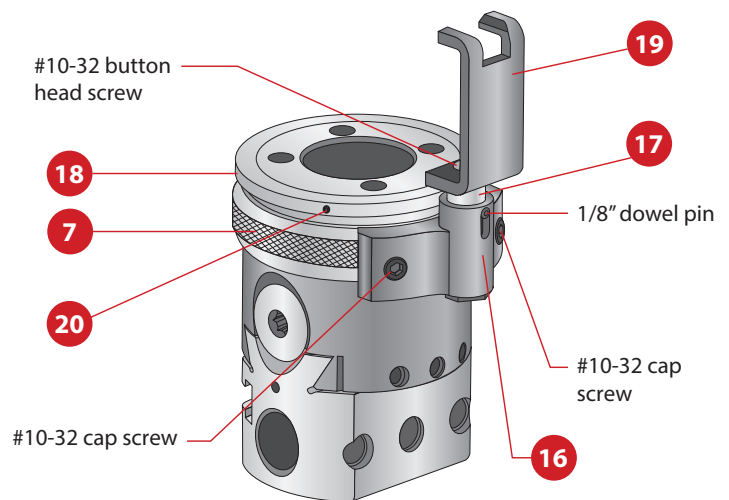

Figure B7

This page left intentionally blank

A

DRILLING

B

BORING

C

REAMING

D

BURNISHING

E

THREADING

X

SPECIALS

ALVAN® Reamers

Replaceable Head Style | Monobloc Style | Cutting Ring Style



Every Option for Every Application

Allied Machine & Engineering is pleased to offer ALVAN® Reamers through an exclusive supply agreement with S.C.A.M.I.® s.n.c., an Italian manufacturer that provides high quality cutting tools.

In addition to producing close tolerances and dimensional accuracy of machined holes, these high performance reaming products provide lower costs per hole through high penetration rates, making them the ideal choice for finishing holes in a production environment. It can also prove to be an alternative to finish boring by providing more consistent hole sizes and lower cycle times.

Excellent hole tolerances	Improves hole quality and surface finish	Expandable design accommodates for wear
---------------------------	--	---

Applicable Industries

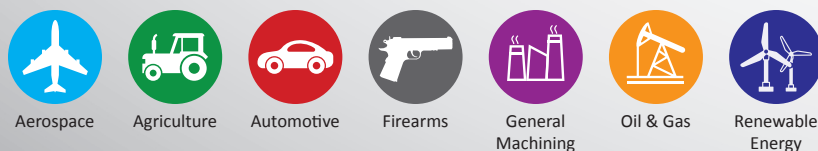

Your safety and the safety of others is very important. This catalog contains important safety messages. Always read and follow all safety precautions.



This triangle is a safety hazard symbol. It alerts you to potential safety hazards that can cause tool failure and serious injury.

When you see this symbol in the catalog, look for a related safety message that may be near this triangle or referred to in the nearby text.

There are safety signal words also used in the catalog. Safety messages follow these words.

WARNING

WARNING (shown above) means that failure to follow the precautions in this message could result in tool failure and serious injury.

NOTICE means that failure to follow the precautions in this message could result in damage to the tool or machine but not result in personal injury.

NOTE and **IMPORTANT** are also used. These are important that you read and follow but are not safety-related.

Visit www.alliedmachine.com for the most up-to-date information and procedures.

Reference Icons

The following icons will appear throughout the catalog to help you navigate between products.



Setup / Assembly Information
Detailed instructions and information regarding the corresponding part(s)

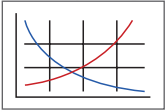

Recommended Cutting Data
Speed and feed recommendations for optimum and safe reaming

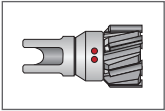

Replaceable Reamer Heads
Refers to the reamer head options that connect to the reamer mandrels

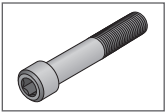

Replaceable Reamer Screws
Refers to the reamer head screw options that connect the head to the reamer mandrels

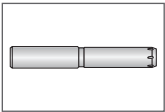

Replaceable Reamer Mandrels
Refers to the reamer mandrel options that connect with the head and screw



Cutting Rings
Refers to the available cutting ring options



Coolant Through Option
Indicates that the product is coolant through



Allied Machine & Engineering offers ALVAN® Reamers through an exclusive supply agreement with S.C.A.M.I.® s.n.c.

S.C.A.M.I. is an Italian manufacturer that has been producing high quality cutting tools for over 40 years. In addition to producing close tolerances and dimensional accuracy of machined holes, this high performance reaming product provides a lower cost-per-hole through its high penetration rates. This makes the ALVAN Reamer product line an ideal choice for finishing holes in a production environment. It can also prove to be an alternative to finish boring by providing more consistent hole sizes and lower cycle times.

Visit www.alliedmachine.com for additional information about all Allied Machine products, or contact our Application Engineering department for technical assistance.

Introduction Information

Case Study Example 2
 Reconditioning Service 3
 Reaming Overview and Selection 4 - 7
 Lead-ins, Coatings, Materials, and Dimples 8 - 9

Replaceable Head Reamers

Product Overview 10
 Product Nomenclature 11
 Heads 12 - 13
 Screws 14 - 15
 Mandrels 16 - 19

Monobloc Reamers

Product Overview 20
 Product Nomenclature 21
 Monobloc Reamers 22 - 29

Ring Style Reamers

Product Overview 30
 Product Nomenclature 31
 Cutting Rings 32 - 33
 Mandrels 34 - 53

Shanks

Radial Adjusting Shanks 54 - 59
 Radial Adjusting Adapters 60 - 61

Recommended Cutting Data

Imperial (inch)	[Replaceable Head Style 62 - 63
		Monobloc Style 64 - 65
		Cutting Ring Style 66 - 67
Metric (mm)	[Replaceable Head Style 68 - 69
		Monobloc Style 70 - 71
		Cutting Ring Style 72 - 73

Technical Information

Set-up: Replaceable Head Style 74
 Set-up: Monobloc Style 75
 Set-up: Cutting Ring Style 76
 Diameter Measurement 77
 TIR Measurement and Adjustment 78 - 79
 Troubleshooting Guide 80

Case Study Example

A
DRILLING
B
BORING
C
REAMING
D
BURNISHING
E
THREADING
X
SPECIALS

CASE STUDY



The **PROOF** is in the **NUMBERS**

Project Profile: Grey Cast Iron Hydraulic Transmission Component
Tooling Solution: ALVAN® Reamer - Monobloc Style

The Problem:

Previously, the customer was using a competitor boring tool running at the following parameters:

- 3802 RPM
- 500 SFM
- 0.003 IPR
- 11.41 IPM

With 2 passes, the tool made a 0.5023" diameter hole to a 1.20" depth.

- Cycle time = 12.6 seconds
- Tool life = 75 parts

Seeking to streamline the production process, the customer needed to increase tool life and lower the cost of production.

The Solution:

Allied Machine recommended the ALVAN® monobloc style reamer.

- **Reamer** = 92440 series carbide, uncoated, V lead

The tool ran at the following parameters:

- 2200 RPM
- 289 SFM
- 0.019 IPR
- 41.80 IPM

The tool achieved the desired diameter and depth, and the results achieved the customer's goals.

- Cycle time = 1.7 seconds
- Tool life = 3,176 parts

The Advantages:

The customer was able to lower the cost of production and increase the tool life.

- Reduced cycle time *from 12.6 seconds to 1.7 seconds*
- Increased tool life *from 75 parts to an incredible 3,176 parts*
- Total cost savings = **\$2,407 (or 52%)**



Tool Life: Competitor Boring
(number of parts = 75)



Tool Life: ALVAN® Monobloc Style Reamer
(number of parts = 3,176)

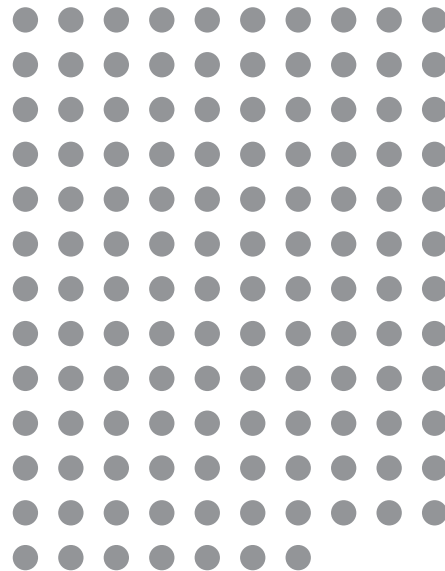



Overall **SAVINGS** of **52%**

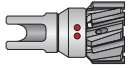

Reconditioning Service

All ALVAN Reamers can be reconditioned to help reduce your overall tooling costs. This service is provided through Allied Machine & Engineering by utilizing the expertise of S.C.A.M.I. We will process the tools with a 25-35 work day lead time, depending on the style, the date we receive the tools, and the purchase order.

Reamer Style	Lead Time (work days)	Part No.	Reconditioned Part No.
 Replaceable Head	25	I7405-SVG-10000	RI7405SVG10000
 Monobloc	35	AL3620I04853	AL3620I04853 RP1
 Cutting Ring	35	AL2TIAI05820	AL2TIAI05820 RP1



Parts to be Reconditioned
(packaged safely)



Purchase Order



Allied Machine & Engineering
Attn: Regrind Department
120 Deeds Drive
Dover, OH 44622
United States

Reaming Overview

A
DRILLING
B
BORING
C
REAMING
D
BURNISHING
E
THREADING
X
SPECIALS

REAMER STYLES



Replaceable Head
Pages C: 10 - 19

- Diameter range: 11.80mm - 60.60mm
- Heads are available as fixed or expanding for improved productivity
- Straight or left hand helical flutes provide solutions for both through and blind holes
- Cylindrical or modular shanks improve concentricity



Monobloc
Pages C: 20 - 29

- Diameter range: 5.80mm - 32.60mm
- Available with central or radial through coolant
- Can be used for through or blind holes
- Cylindrical shanks improve concentricity
- Expandable to accommodate for wear



Cutting Ring
Pages C: 30 - 53

- Diameter range: 17.60mm - 200.60mm
- The cutting edges are positioned asymmetrically to assure the best roundness of the hole
- Holes with tight tolerances can be accommodated, and the expansion ensures a perfect holding of the reaming diameter

General Reaming Notes

- If the depth is over 9xD, use a short length reamer to pilot the hole. Then finish with the longer length ⚠.
- For blind hole applications, always use central coolant. If in doubt, contact Allied's Application Engineering department.
- More stock allowance can be taken in softer materials. Less stock allowance should be taken in harder materials.
- A common practice to rapid out of the cut on through holes and to breakout only 2mm past the reaming depth.

IMPORTANT: Always use molykote (anti-seize applicant) on the conical seat and the threads on the central screw for assembly.

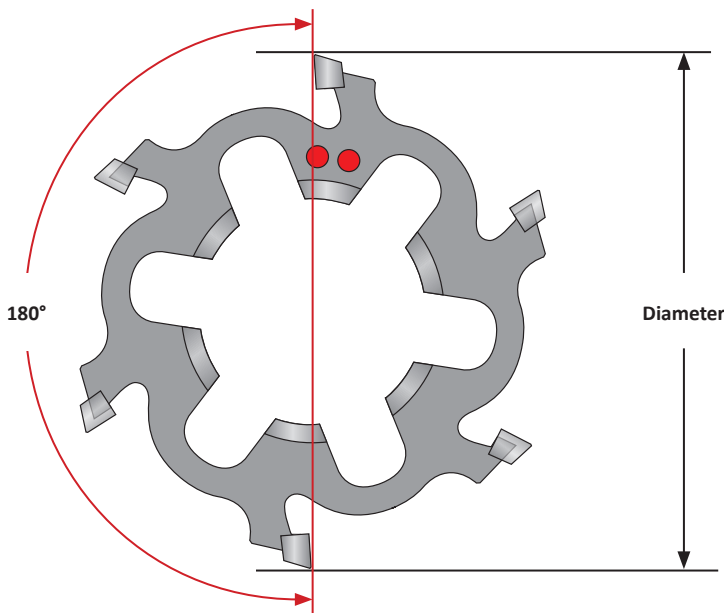
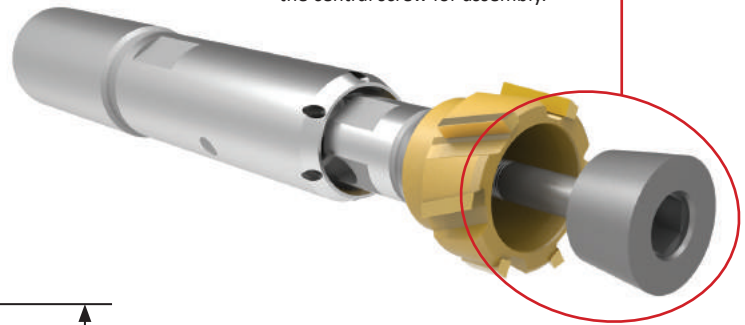

NOTE: The position of the dimples indicates which 2 cutting teeth are 180° opposed. Diameter measurements should be taken from these 2 cutting teeth.



⚠ WARNING Tool failure can cause serious injury. To prevent:

- When using holders without support bushing, use a shorter reamer to establish the initial hole diameter that is a minimum of 2 diameters deep.
- Do not rotate reamers more than 50 RPM unless it is engaged with the workpiece or fixture.

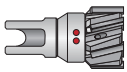
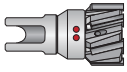

Factory technical assistance is available for your specific applications through our Application Engineering Team.

Quick Selection Guide

Breakdown by Diameter

Reamer Style	0.2283" 5.799mm	0.4656" 11.800mm	0.6929" 17.600mm	1.1024" 28.000mm	1.2638" 32.100mm	1.7717" 45.000mm	2.3858" 60.600mm	3.7402" 95.000mm	5.1181" 130.000mm	6.4961" 165.000mm	7.8975" 200.600mm
 Replaceable Head (Fixed)		[Red bar]									
 Replaceable Head (Expandable)		[Red bar]									
 Monobloc	[Red bar]										
 Cutting Ring			[Red bar]								

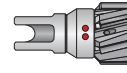
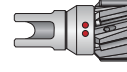
Breakdown by Features

Reamer Style	Capable Tolerance	Fastest Set-up	Replaceable Cutting Head	Expandable to Adjust for Wear	Recondition Available	Cylindrical Shanks	Modular Shanks	Through Coolant Options
 Replaceable Head (fixed)	H7	<input checked="" type="checkbox"/>	<input checked="" type="checkbox"/>		<input checked="" type="checkbox"/>	<input checked="" type="checkbox"/>	<input checked="" type="checkbox"/>	<input checked="" type="checkbox"/>
 Replaceable Head (expandable)	H6		<input checked="" type="checkbox"/>	<input checked="" type="checkbox"/>	<input checked="" type="checkbox"/>	<input checked="" type="checkbox"/>	<input checked="" type="checkbox"/>	<input checked="" type="checkbox"/>
 Monobloc	H6			<input checked="" type="checkbox"/>	<input checked="" type="checkbox"/>	<input checked="" type="checkbox"/>		<input checked="" type="checkbox"/>
 Cutting Ring	H6		<input checked="" type="checkbox"/>	<input checked="" type="checkbox"/>	<input checked="" type="checkbox"/>	<input checked="" type="checkbox"/>	<input checked="" type="checkbox"/>	<input checked="" type="checkbox"/>

For more details on how to select a reamer, see the following pages.

How the Reamer Works

How the Reamer Works

- The cut is made in the lead-in zone (3), and the chip is made on the cutting face (1). The chip is removed by coolant.
- The lead-in (3) is defined depending on the application, the workpiece material, and the stock allowance.
- The radial land (2) is important for holding a good alignment, improving the surface roughness, and giving an effect similar to burnishing. The dimension of the radial land depends on the diameter.
- The radial land (2) is manufactured to be tapered on the rear.
- Fixed reamers are manufactured at the exact tapered value. Expandable reamers must be adjusted to the exact diameter. Both are already supplied at the nominal diameter by the manufacturer.
- The undercut of the cutting edge (5) avoids retract marks on the piece when the reamer is retracted from the cut.
- The front of the cutting edge (6) does not cut; if this feature is needed, a frontal lead must be supplied.

When to Apply a Reamer

- When the requested tolerance on diameter is IT8 or less
- When the requested finish is 63 µin (1.6 µmm) Ra or greater
- When the critical geometry characteristics of the hole are the roundness and straightness
- When parts are being mass produced
- When the parts are large and expensive

Elements of the Cutting Tooth

- (1) Cutting Face
- (2) Radial Land
- (3) Lead-in / Primary Face / Secondary Face
- (4) Rear Face
- (5) Undercut of Cutting Edge
- (6) Front of Cutting Edge

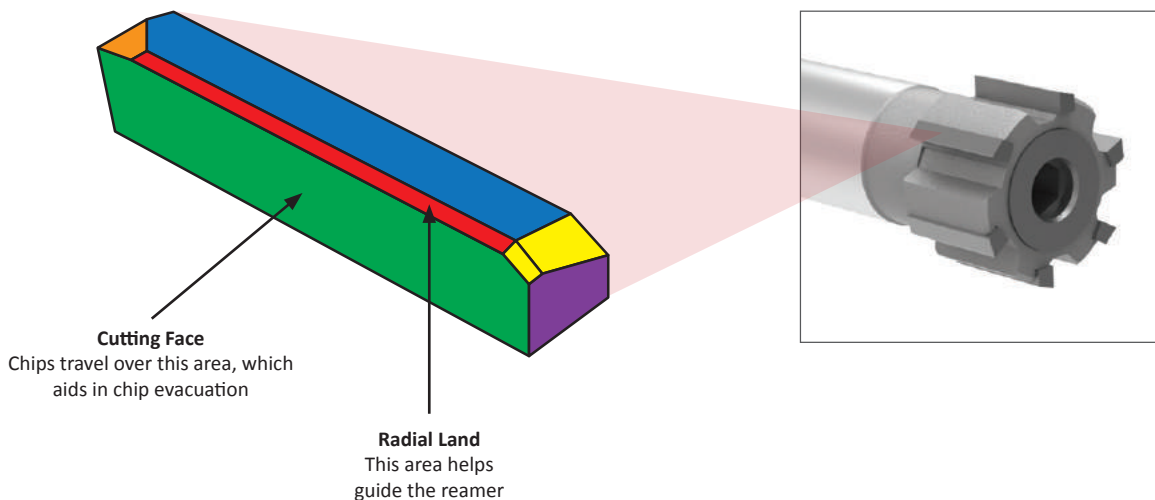

Reamer Recommendation Guide

ISO	Material	Hardness (BHN)	Through Hole				Blind Hole			
			Uninterrupted		Interrupted		Uninterrupted		Interrupted	
			Lead	Substrate & Coating	Lead	Substrate & Coating	Lead	Substrate & Coating	Lead	Substrate & Coating
P	Free Machining Steel 1118, 1215, 12L14, etc.	Below 150	N or E	Cermet Uncoated	E	Cermet Uncoated	J	Cermet Uncoated	V	Cermet Uncoated
		150 Above								
	Low Carbon Steel 1010, 1020, 1522, 1144, etc.	Below 250	N or E	Cermet Uncoated	E	Cermet Uncoated	J	Cermet Uncoated	V	Cermet Uncoated
	Medium Carbon Steel 1030, 1040, 1050, 1140, 1151, etc.	Below 300	N or E	Cermet Uncoated	E	Cermet Uncoated	X	Cermet Uncoated	V	Cermet Uncoated
	Alloy Steel 4140, 5140, 8640, etc.	Below 350	G or M	Cermet Uncoated	M	Cermet Uncoated	X	Cermet Uncoated	G	Cermet Uncoated
	High Strength Alloy 4340, 4330V, 300M, etc.	240 - 450	G or M*	Carbide Alcrona	M	Carbide Alcrona	X*	Carbide Alcrona	G*	Carbide Alcrona
	Structural Steel	–	E	Cermet	M	Carbide TiAlN	X	Cermet	G	Carbide TiAlN
Tool Steel	–	M*	Carbide TiAlN	M*	Carbide TiAlN	X*	Carbide TiAlN	G*	Carbide TiAlN	
S	High Temp Alloy	–	G*	Carbide TiAlN	G*	Carbide TiAlN	X*	Carbide TiAlN	G*	Carbide TiAlN
	Titanium Alloys	–	T	Carbide TiAlN	T	Carbide TiAlN	T	Carbide TiAlN	T	Carbide TiAlN
M	Austenitic Stainless Steel 304, 316, etc.	–	E	Carbide Alcrona	E	Carbide Alcrona	X	Carbide Alcrona	G*	Carbide Alcrona
	Ferritic Martensitic Stainless Steel 416, 420, 17-4PH, 15-5PH, etc.	–	N or E	Cermet or Carbide Alcrona	E	Cermet or Carbide Alcrona	X	Cermet or Carbide Alcrona	G	Cermet or Carbide Alcrona
K	Ductile Cast Iron Spheroidal - GS500	Below 130	V	Carbide Alcrona	V	Carbide Alcrona	J	Carbide Alcrona	V	Carbide Alcrona
		130 Above		Cermet Alcrona		Cermet Alcrona		Cermet Alcrona		
	Grey Cast Iron GC15 - GC20 - GC25 - GC35	–	V	Carbide TiAlN	V	Carbide TiAlN	J	Carbide TiAlN	V	Carbide TiAlN
N	Bronze Brass Copper	Below 300	E	Carbide Uncoated	E	Carbide Uncoated	X	Carbide Uncoated	G	Carbide Uncoated
	Aluminum	Below 7% Si	V	Carbide Uncoated	V	Carbide Uncoated	V	Carbide Uncoated	G	Carbide Uncoated
		Above 7% Si	G	PCD Uncoated	G	PCD Uncoated	G	PCD Uncoated		PCD Uncoated

*Contact our Application Engineering department for special geometries to improve tool life.

A DRILLING
B BORING
C REAMING
D BURNISHING
E THREADING
X SPECIALS

Lead-in Angle Information

A
DRILLING
B
BORING
C
REAMING
D
BURNISHING
E
THREADING
X
SPECIALS



Straight Flute

Lead-in	Angles	Chip Evacuation	Description
A	45° 8°		Lead-in can be used to improve finish.
F or Y	90°		Can be used for stock removal at the bottom of the hole. Reduce the feed by 40% of the values on the recommended cutting data pages. F lead = no chipbreaker Y lead = chipbreaker
G or X	45°		Standard and suitable for most materials. G lead = no chipbreaker X lead = chipbreaker
L or W	75°		May provide improved straightness. Reduce the feed by 40% of the values on the recommended cutting data pages. L lead = no chipbreaker W lead = chipbreaker
N	20°		Ideal for through holes. It is possible to increase the feed up to 100% of the values on the recommended cutting data pages.
T	30°		Suitable for titanium based alloys.
V or J	45°		Suitable for most materials and increases tool life V lead = no chipbreaker J lead = chipbreaker

Helical Flute (Left Hand) - Through Hole Applications Only

Lead-in	Angles	Chip Evacuation	Description
E	25°		Standard and suitable for most materials. NOTE: Through hole applications only.
M	45°		May provide better penetration rates in steels over 200 BHN. NOTE: Through hole applications only.

Coatings, Cutting Materials, and Dimple Indicators

Coating Information

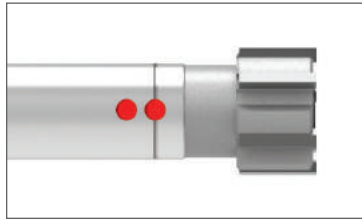

Uncoated

Ideal for non-ferrous applications

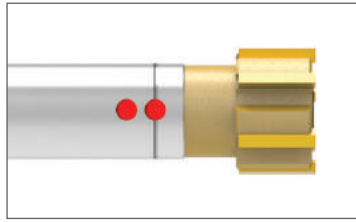

TiN (N)

Ideal for general purpose applications

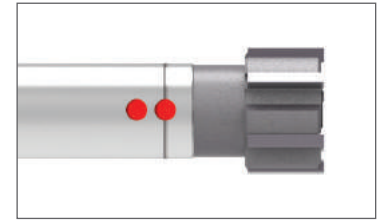

TiAlN (A)

Provides higher heat resistance to improve tool life

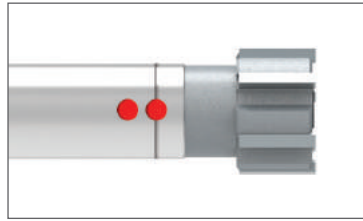

TiCN (C)

Provides improved surface finish

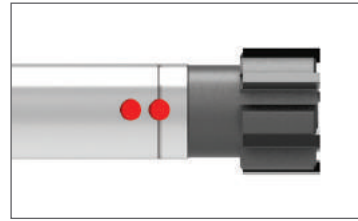





Alcrona (K)

Provides excellent wear resistance and can help increase cutting speeds

Cutting Material Information

Material	Indicator	Details
Carbide	K	A fine-grain carbide suitable for all conventional reaming applications. Recommended where rigidity is not excellent and speeds must be reduced.
Cermet	S	Cermet provides high wear resistance and is recommended for abrasive and increased speed applications. Not recommended for poor rigidity or interrupted cuts.

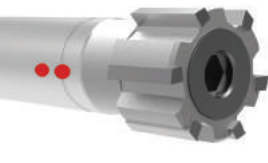
Dimple Indicators

Material	Indicator	Replaceable Head Style	Monobloc Style	Cutting Ring Style
Carbide	Two Dimples			
Cermet	Two Dimples with Line			

NOTE: The dimple location indicates which 2 cutting teeth are 180° opposed

Replaceable Head Reamers

Product Overview

Fixed Heads
<ul style="list-style-type: none"> • Non-expanding diameter • Locking screw is straight (no taper) • Allows for on-machine replacement • Capable of H7 tolerance on diameter • Available in straight and left hand helical flutes • Available for recondition

Expandable Heads
<ul style="list-style-type: none"> • Expandable diameter (1% of nominal diameter) to accommodate for wear • Conical locking screw • Requires set-up for diameter • Capable of tight diameter tolerance ($\pm 0.0002''$ (0.005mm)) • Available in straight and left hand helical flutes • Available for recondition

Mandrels
<ul style="list-style-type: none"> • Available in short, standard, and long lengths • Reamer head design allows multiple diameters to be used within the same mandrel, which reduces inventory requirements • The same mandrel can use both fixed and expandable heads • Coolant options are offered for both through and blind hole scenarios



Uncoated



TiN Coated



TiAlN Coated



TiCN Coated



Alcrona Coated

Mandrel Shanks Available:

- Cylindrical
- Modular Connection

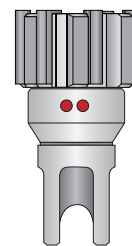

Straight Flute

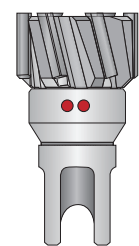

Left Hand Helical Flute

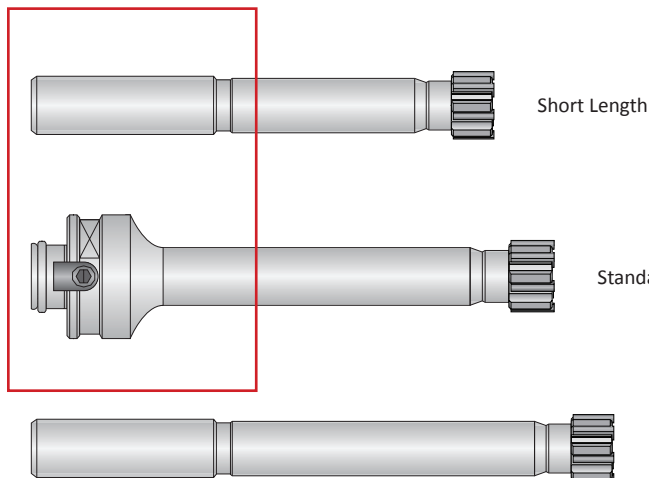

Type of Head	Coated/Uncoated	Lead Time in Work Days (based on number of pieces)		
		Up to 5	6 - 19	20+
Fixed	Coated	15	25	25
	Uncoated	10	20	20
Expandable	Coated	20	25	30
	Uncoated	15	20	25

Product Nomenclature

Replaceable Head Style Reamer Heads

I	77	00	-	K	N	G	-	18000
1	2	3		4	5	6		7

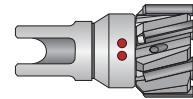

NOTE: If tool is reconditioned, put an "R" at the beginning of the item number

1. Shank Measure Blank = Metric I = Inch	2. Flute Style 74 = Straight 77 = Left hand helical	3. Head Style 00 = Fixed head 05 = Expandable head	4. Substrate K = Carbide S = Cermet	5. Coating L = Uncoated carbide V = Uncoated cermet N = TiN C = TiCN A = TiAlN K = Alcrona
6. Lead-in E, M = Left hand helical flute A, F, G, L, N, T, V = Straight flute J, W, X, Y = Straight flute with chipbreaker	7. Diameter XX.XXX = Metric X.XXXX = Inch			

Reference Key

Symbol	Attribute
D_1	Reamer head diameter
D_2	Shank diameter
L_1	Overall length
L_2	Length of cut
H	Hex key (listed with screws)

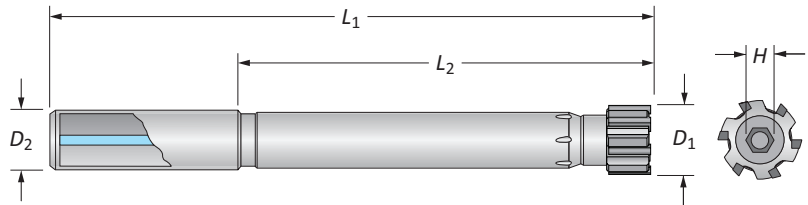

Building Your Complete Tool

You will need all three pieces to complete your replaceable head reamer assembly. The item numbers for the screws and the mandrels are listed on their respective pages. However, there is a guide on the pages where the heads are located. You must follow the guide to build the item number for the reamer head that you need.

The complete mandrel item numbers are listed on their respective pages. You do not need to build the mandrel numbers.

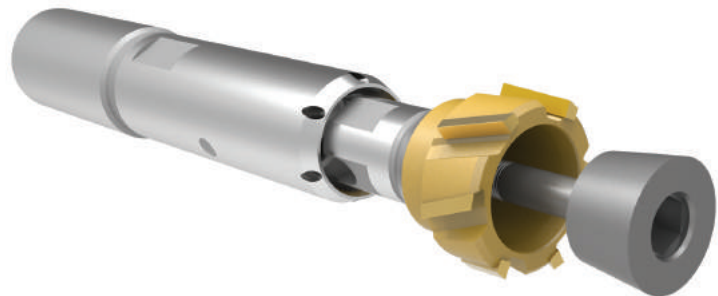

1

Select Your Head

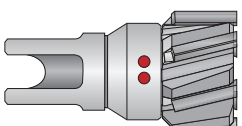

2

Select Your Screw



3

Select Your Mandrel



Replaceable Heads

Fixed

A DRILLING
B BORING
C REAMING
D BURNISHING
E THREADING
X SPECIALS

Build Your Part No.

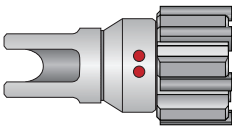
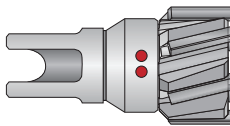
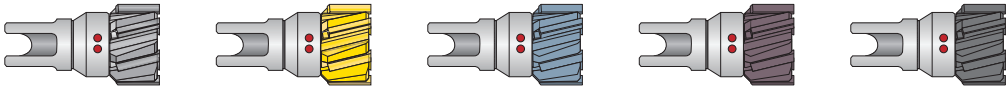
1 Series	7400 Series	7700 Series																																																								
2 Flute Style Your flute style is based on your series selection (above)	Straight Flute 	Helical Flute (Left Hand) 																																																								
3 Carbide Grade and Coating Codes These are the combinations of grades and coatings you can choose from																																																										
	<table border="1" style="width: 100%; text-align: center;"> <thead> <tr> <th></th> <th>Uncoated</th> <th>TiN</th> <th>TiCN</th> <th>TiAlN</th> <th>Alcrona</th> </tr> </thead> <tbody> <tr> <th>Carbide</th> <td>KL</td> <td>KN</td> <td>KC</td> <td>KA</td> <td>KK</td> </tr> <tr> <th>Cermet</th> <td>SV</td> <td>SN</td> <td>SC</td> <td>SA</td> <td>SK</td> </tr> </tbody> </table>						Uncoated	TiN	TiCN	TiAlN	Alcrona	Carbide	KL	KN	KC	KA	KK	Cermet	SV	SN	SC	SA	SK																																			
	Uncoated	TiN	TiCN	TiAlN	Alcrona																																																					
Carbide	KL	KN	KC	KA	KK																																																					
Cermet	SV	SN	SC	SA	SK																																																					
4 Lead-in Recommendations	<table border="1" style="width: 100%; text-align: center;"> <thead> <tr> <th></th> <th>T</th> <th>F</th> <th>N</th> <th>G</th> <th>L</th> <th>A</th> <th>V</th> </tr> </thead> <tbody> <tr> <th>P</th> <td></td> <td></td> <td>●</td> <td>●</td> <td></td> <td>○</td> <td>○</td> </tr> <tr> <th>S</th> <td>●</td> <td></td> <td></td> <td>○</td> <td></td> <td></td> <td></td> </tr> <tr> <th>M</th> <td></td> <td></td> <td></td> <td>●</td> <td>○</td> <td></td> <td></td> </tr> <tr> <th>H</th> <td></td> <td></td> <td>○</td> <td>●</td> <td></td> <td></td> <td></td> </tr> <tr> <th>K</th> <td>○</td> <td></td> <td></td> <td>●</td> <td></td> <td></td> <td>○</td> </tr> <tr> <th>N</th> <td></td> <td></td> <td></td> <td>●</td> <td></td> <td>●</td> <td>○</td> </tr> </tbody> </table>			T	F	N	G	L	A	V	P			●	●		○	○	S	●			○				M				●	○			H			○	●				K	○			●			○	N				●		●	○
	T	F	N	G	L	A	V																																																			
P			●	●		○	○																																																			
S	●			○																																																						
M				●	○																																																					
H			○	●																																																						
K	○			●			○																																																			
N				●		●	○																																																			
5 Diameter (H7 Tolerance) For the diameter portion of the item number, refer to the following tables:	<table border="1" style="width: 100%; text-align: center;"> <thead> <tr> <th colspan="2">Imperial (in)</th> <th colspan="2">Metric (mm)</th> </tr> <tr> <th>D₁ Range</th> <th>Tolerance (min/max)</th> <th>D₁ Range</th> <th>Tolerance (min/max)</th> </tr> </thead> <tbody> <tr> <td>0.4656 - 0.7086</td> <td>+0 / +0.0007</td> <td>11.800 - 18.000</td> <td>+0 / +0.018</td> </tr> <tr> <td>0.7087 - 1.1811</td> <td>+0 / +0.0008</td> <td>18.001 - 30.000</td> <td>+0 / +0.021</td> </tr> <tr> <td>1.1812 - 1.9685</td> <td>+0 / +0.0010</td> <td>30.001 - 50.000</td> <td>+0 / +0.025</td> </tr> <tr> <td>1.9686 - 2.3858</td> <td>+0 / +0.0012</td> <td>50.001 - 60.600</td> <td>+0 / +0.030</td> </tr> </tbody> </table>		Imperial (in)		Metric (mm)		D ₁ Range	Tolerance (min/max)	D ₁ Range	Tolerance (min/max)	0.4656 - 0.7086	+0 / +0.0007	11.800 - 18.000	+0 / +0.018	0.7087 - 1.1811	+0 / +0.0008	18.001 - 30.000	+0 / +0.021	1.1812 - 1.9685	+0 / +0.0010	30.001 - 50.000	+0 / +0.025	1.9686 - 2.3858	+0 / +0.0012	50.001 - 60.600	+0 / +0.030																																
Imperial (in)		Metric (mm)																																																								
D ₁ Range	Tolerance (min/max)	D ₁ Range	Tolerance (min/max)																																																							
0.4656 - 0.7086	+0 / +0.0007	11.800 - 18.000	+0 / +0.018																																																							
0.7087 - 1.1811	+0 / +0.0008	18.001 - 30.000	+0 / +0.021																																																							
1.1812 - 1.9685	+0 / +0.0010	30.001 - 50.000	+0 / +0.025																																																							
1.9686 - 2.3858	+0 / +0.0012	50.001 - 60.600	+0 / +0.030																																																							

● Best ○ Better ○ Good





Ordering Example:

The customer needs the following:

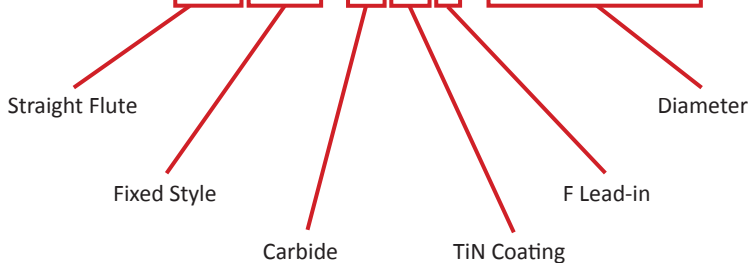
- Straight fluted reamer head
- Fixed style
- Carbide
- TiN coating
- F lead-in
- 1.9686" diameter

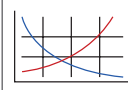
7400-KNF-1.9686

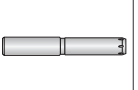
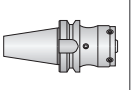

C: 62 - 73 	C: 14 - 15 	C: 16 - 18 	C: 54 - 61 	C: 74 
---	---	---	---	--

Key on C: 1

Replaceable Heads

Expandable

Build Your Part No.

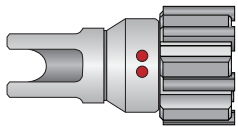
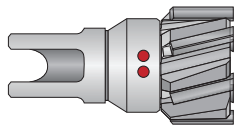
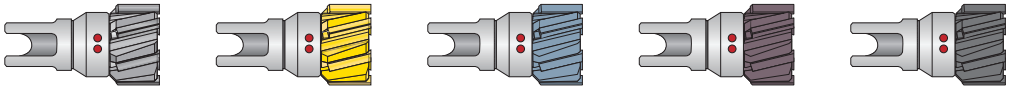
1 Series	7405 Series	7705 Series																																																																													
2 Flute Style Your flute style is based on your series selection (above)	Straight Flute 	Helical Flute (Left Hand) 																																																																													
3 Carbide Grade and Coating Codes These are the combinations of grades and coatings you can choose from	 <table border="1"> <thead> <tr> <th></th> <th>Uncoated</th> <th>TiN</th> <th>TiCN</th> <th>TiAlN</th> <th>Alcrona</th> </tr> </thead> <tbody> <tr> <th>Carbide</th> <td>KL</td> <td>KN</td> <td>KC</td> <td>KA</td> <td>KK</td> </tr> <tr> <th>Cermet</th> <td>SV</td> <td>SN</td> <td>SC</td> <td>SA</td> <td>SK</td> </tr> </tbody> </table>			Uncoated	TiN	TiCN	TiAlN	Alcrona	Carbide	KL	KN	KC	KA	KK	Cermet	SV	SN	SC	SA	SK																																																											
	Uncoated	TiN	TiCN	TiAlN	Alcrona																																																																										
Carbide	KL	KN	KC	KA	KK																																																																										
Cermet	SV	SN	SC	SA	SK																																																																										
4 Lead-in Recommendations	<table border="1"> <thead> <tr> <th></th> <th>T</th> <th>F</th> <th>N</th> <th>G</th> <th>L</th> <th>A</th> <th>V</th> </tr> </thead> <tbody> <tr> <th>P</th> <td></td> <td></td> <td>●</td> <td>●</td> <td></td> <td>◐</td> <td>○</td> </tr> <tr> <th>S</th> <td>●</td> <td></td> <td></td> <td>◐</td> <td></td> <td></td> <td></td> </tr> <tr> <th>M</th> <td></td> <td></td> <td></td> <td>●</td> <td>◐</td> <td></td> <td></td> </tr> <tr> <th>H</th> <td></td> <td></td> <td>◐</td> <td>●</td> <td></td> <td></td> <td></td> </tr> <tr> <th>K</th> <td>○</td> <td></td> <td></td> <td>●</td> <td></td> <td></td> <td>◐</td> </tr> <tr> <th>N</th> <td></td> <td></td> <td></td> <td>●</td> <td></td> <td>●</td> <td>◐</td> </tr> </tbody> </table>		T	F	N	G	L	A	V	P			●	●		◐	○	S	●			◐				M				●	◐			H			◐	●				K	○			●			◐	N				●		●	◐	<table border="1"> <thead> <tr> <th></th> <th>E</th> <th>M</th> </tr> </thead> <tbody> <tr> <th>P</th> <td>●</td> <td></td> </tr> <tr> <th>S</th> <td>●</td> <td>◐</td> </tr> <tr> <th>M</th> <td>●</td> <td></td> </tr> <tr> <th>H</th> <td>◐</td> <td>●</td> </tr> <tr> <th>K</th> <td>◐</td> <td>●</td> </tr> <tr> <th>N</th> <td>●</td> <td>◐</td> </tr> </tbody> </table>		E	M	P	●		S	●	◐	M	●		H	◐	●	K	◐	●	N	●	◐
	T	F	N	G	L	A	V																																																																								
P			●	●		◐	○																																																																								
S	●			◐																																																																											
M				●	◐																																																																										
H			◐	●																																																																											
K	○			●			◐																																																																								
N				●		●	◐																																																																								
	E	M																																																																													
P	●																																																																														
S	●	◐																																																																													
M	●																																																																														
H	◐	●																																																																													
K	◐	●																																																																													
N	●	◐																																																																													
5 Diameter (H7 Tolerance) For the diameter portion of the item number, refer to the following tables:	<table border="1"> <thead> <tr> <th colspan="2">Imperial (in)</th> <th colspan="2">Metric (mm)</th> </tr> <tr> <th>D₁ Range</th> <th>Tolerance (min/max)</th> <th>D₁ Range</th> <th>Tolerance (min/max)</th> </tr> </thead> <tbody> <tr> <td>0.4656 - 0.7086</td> <td rowspan="5">-0.0002 / +0.0002</td> <td>11.800 - 18.000</td> <td rowspan="5">-0.005 / +0.005</td> </tr> <tr> <td>0.7087 - 1.1811</td> <td>18.001 - 30.000</td> </tr> <tr> <td>1.1812 - 1.5748</td> <td>30.001 - 40.000</td> </tr> <tr> <td>1.5749 - 1.9685</td> <td>40.001 - 50.000</td> </tr> <tr> <td>1.9686 - 2.3858</td> <td>50.001 - 60.600</td> </tr> </tbody> </table>		Imperial (in)		Metric (mm)		D ₁ Range	Tolerance (min/max)	D ₁ Range	Tolerance (min/max)	0.4656 - 0.7086	-0.0002 / +0.0002	11.800 - 18.000	-0.005 / +0.005	0.7087 - 1.1811	18.001 - 30.000	1.1812 - 1.5748	30.001 - 40.000	1.5749 - 1.9685	40.001 - 50.000	1.9686 - 2.3858	50.001 - 60.600																																																									
Imperial (in)		Metric (mm)																																																																													
D ₁ Range	Tolerance (min/max)	D ₁ Range	Tolerance (min/max)																																																																												
0.4656 - 0.7086	-0.0002 / +0.0002	11.800 - 18.000	-0.005 / +0.005																																																																												
0.7087 - 1.1811		18.001 - 30.000																																																																													
1.1812 - 1.5748		30.001 - 40.000																																																																													
1.5749 - 1.9685		40.001 - 50.000																																																																													
1.9686 - 2.3858		50.001 - 60.600																																																																													

● Best ◐ Better ○ Good

Ordering Example:

The customer needs the following:

- Straight fluted reamer head
- Expandable style
- Carbide
- TiN coating
- F lead-in
- 1.9686" diameter

7405-KNF-1.9686

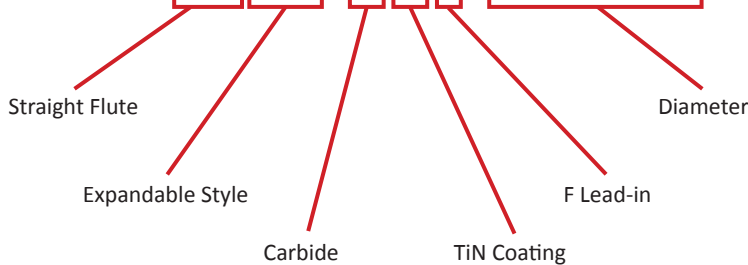

C: 62 - 73 C: 14 - 15 C: 16 - 18 C: 54 - 61 C: 74

Replaceable Head Screws

Fixed

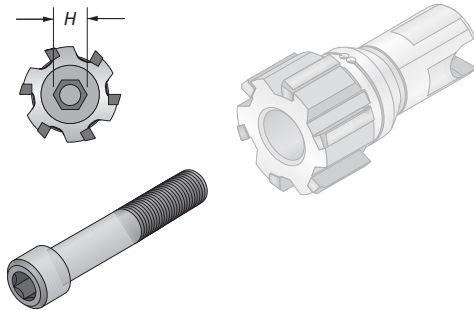

7000 Series

D_1 Range (inch)	D_1 Range (mm)	Part No.	H (mm)
0.4646 - 0.5751	11.800 - 14.609	7000-VI-001	2.5
0.5752 - 0.6932	14.610 - 17.609	7000-VI-002	3
0.6933 - 0.8507	17.610 - 21.609	7000-VI-003	4
0.8508 - 1.0475	21.610 - 26.609	7000-VI-004	5
1.0476 - 1.2838	26.610 - 32.609	7000-VI-005	6
1.2839 - 1.5987	32.610 - 40.609	7000-VI-006	6
1.5988 - 1.9924	40.610 - 50.609	7000-VI-007	8
1.9925 - 2.3858	50.610 - 60.600	7000-VI-008	10

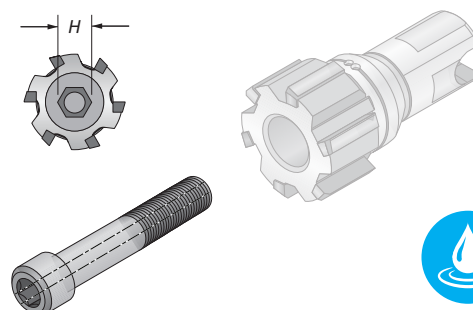

7001 Series

D_1 Range (inch)	D_1 Range (mm)	Part No.	H (mm)
0.4646 - 0.5751	11.800 - 14.609	7001-VI-001	2.5
0.5752 - 0.6932	14.610 - 17.609	7001-VI-002	3
0.6933 - 0.8507	17.610 - 21.609	7001-VI-003	4
0.8508 - 1.0475	21.610 - 26.609	7001-VI-004	5
1.0476 - 1.2838	26.610 - 32.609	7001-VI-005	6
1.2839 - 1.5987	32.610 - 40.609	7001-VI-006	6
1.5988 - 1.9924	40.610 - 50.609	7001-VI-007	8
1.9925 - 2.3858	50.610 - 60.600	7001-VI-008	10

A

DRILLING

B

BORING

C

REAMING

D

BURNISHING

E

THREADING

X

SPECIALS

C: 62 - 73

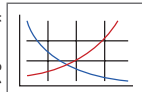

C: 12 - 13

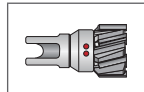

C: 16 - 18

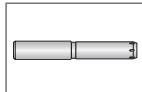

C: 54 - 61

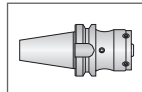

C: 74





Replaceable Head Screws

Expandable

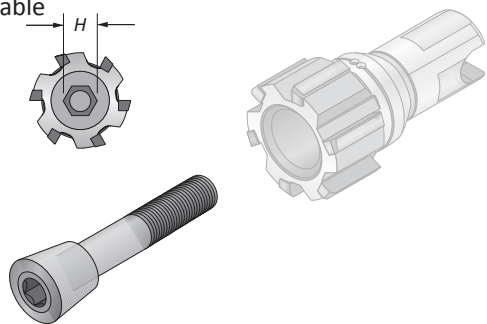

7000 Series

D ₁ Range (inch)	D ₁ Range (mm)	Part No.	H (mm)
0.4646 - 0.4964	11.800 - 12.609	7000-VI-012	3.5
0.4965 - 0.5357	12.610 - 13.609	7000-VI-013	3.5
0.5358 - 0.5751	13.610 - 14.609	7000-VI-014	3.5
0.5752 - 0.6145	14.610 - 15.609	7000-VI-015	4
0.6146 - 0.6538	15.610 - 16.609	7000-VI-016	4
0.6539 - 0.6932	16.610 - 17.609	7000-VI-017	4
0.6933 - 0.7326	17.610 - 18.609	7000-VI-018	5
0.7327 - 0.7719	18.610 - 19.609	7000-VI-019	5
0.7720 - 0.8113	19.610 - 20.609	7000-VI-020	5
0.8114 - 0.8507	20.610 - 21.609	7000-VI-021	5
0.8508 - 0.8901	21.610 - 22.609	7000-VI-022	6
0.8902 - 0.9294	22.610 - 23.609	7000-VI-023	6
0.9295 - 0.9688	23.610 - 24.609	7000-VI-024	6
0.9689 - 1.0082	24.610 - 25.609	7000-VI-025	6
1.0083 - 1.0475	25.610 - 26.609	7000-VI-026	6
1.0476 - 1.0869	26.610 - 27.609	7000-VI-027	8
1.0870 - 1.1263	27.610 - 28.609	7000-VI-028	8
1.1264 - 1.1656	28.610 - 29.609	7000-VI-029	8
1.1657 - 1.2050	29.610 - 30.609	7000-VI-030	8
1.2051 - 1.2444	30.610 - 31.609	7000-VI-031	8
1.2445 - 1.2838	31.610 - 32.609	7000-VI-032	8
1.2839 - 1.3231	32.610 - 33.609	7000-VI-033	8
1.3232 - 1.3625	33.610 - 34.609	7000-VI-034	10
1.3626 - 1.4019	34.610 - 35.609	7000-VI-035	10
1.4020 - 1.4412	35.610 - 36.609	7000-VI-036	10
1.4413 - 1.4806	36.610 - 37.609	7000-VI-037	10
1.4807 - 1.5200	37.610 - 38.609	7000-VI-038	10
1.5201 - 1.5593	38.610 - 39.609	7000-VI-039	10
1.5594 - 1.5987	39.610 - 40.609	7000-VI-040	10
1.5988 - 1.6381	40.610 - 41.609	7000-VI-041	12
1.6382 - 1.6775	41.610 - 42.609	7000-VI-042	12
1.6776 - 1.7168	42.610 - 43.609	7000-VI-043	12
1.7169 - 1.7562	43.610 - 44.609	7000-VI-044	12
1.7563 - 1.7956	44.610 - 45.609	7000-VI-045	12
1.7957 - 1.8349	45.610 - 46.609	7000-VI-046	12
1.8350 - 1.8743	46.610 - 47.609	7000-VI-047	12
1.8744 - 1.9137	47.610 - 48.609	7000-VI-048	12
1.9138 - 1.9530	48.610 - 49.609	7000-VI-049	12
1.9531 - 1.9924	49.610 - 50.609	7000-VI-050	12
1.9925 - 2.0318	50.610 - 51.609	7000-VI-051	12
2.0319 - 2.0712	51.610 - 52.609	7000-VI-052	12
2.0713 - 2.1105	52.610 - 53.609	7000-VI-053	12
2.1106 - 2.1499	53.610 - 54.609	7000-VI-054	12
2.1500 - 2.1893	54.610 - 55.609	7000-VI-055	12
2.1894 - 2.2286	55.610 - 56.609	7000-VI-056	12
2.2287 - 2.2680	56.610 - 57.609	7000-VI-057	12
2.2681 - 2.3074	57.610 - 58.609	7000-VI-058	12
2.3075 - 2.3468	58.610 - 59.609	7000-VI-059	12
2.3469 - 2.3858	59.610 - 60.609	7000-VI-060	12

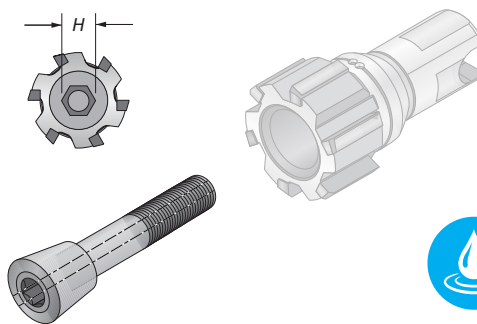

7001 Series

D ₁ Range (inch)	D ₁ Range (mm)	Part No.	H (mm)
0.4646 - 0.4964	11.800 - 12.609	7001-VI-012	3.5
0.4965 - 0.5357	12.610 - 13.609	7001-VI-013	3.5
0.5358 - 0.5751	13.610 - 14.609	7001-VI-014	3.5
0.5752 - 0.6145	14.610 - 15.609	7001-VI-015	4
0.6146 - 0.6538	15.610 - 16.609	7001-VI-016	4
0.6539 - 0.6932	16.610 - 17.609	7001-VI-017	4
0.6933 - 0.7326	17.610 - 18.609	7001-VI-018	5
0.7327 - 0.7719	18.610 - 19.609	7001-VI-019	5
0.7720 - 0.8113	19.610 - 20.609	7001-VI-020	5
0.8114 - 0.8507	20.610 - 21.609	7001-VI-021	5
0.8508 - 0.8901	21.610 - 22.609	7001-VI-022	6
0.8902 - 0.9294	22.610 - 23.609	7001-VI-023	6
0.9295 - 0.9688	23.610 - 24.609	7001-VI-024	6
0.9689 - 1.0082	24.610 - 25.609	7001-VI-025	6
1.0083 - 1.0475	25.610 - 26.609	7001-VI-026	6
1.0476 - 1.0869	26.610 - 27.609	7001-VI-027	8
1.0870 - 1.1263	27.610 - 28.609	7001-VI-028	8
1.1264 - 1.1656	28.610 - 29.609	7001-VI-029	8
1.1657 - 1.2050	29.610 - 30.609	7001-VI-030	8
1.2051 - 1.2444	30.610 - 31.609	7001-VI-031	8
1.2445 - 1.2838	31.610 - 32.609	7001-VI-032	8
1.2839 - 1.3231	32.610 - 33.609	7001-VI-033	8
1.3232 - 1.3625	33.610 - 34.609	7001-VI-034	10
1.3626 - 1.4019	34.610 - 35.609	7001-VI-035	10
1.4020 - 1.4412	35.610 - 36.609	7001-VI-036	10
1.4413 - 1.4806	36.610 - 37.609	7001-VI-037	10
1.4807 - 1.5200	37.610 - 38.609	7001-VI-038	10
1.5201 - 1.5593	38.610 - 39.609	7001-VI-039	10
1.5594 - 1.5987	39.610 - 40.609	7001-VI-040	10
1.5988 - 1.6381	40.610 - 41.609	7001-VI-041	12
1.6382 - 1.6775	41.610 - 42.609	7001-VI-042	12
1.6776 - 1.7168	42.610 - 43.609	7001-VI-043	12
1.7169 - 1.7562	43.610 - 44.609	7001-VI-044	12
1.7563 - 1.7956	44.610 - 45.609	7001-VI-045	12
1.7957 - 1.8349	45.610 - 46.609	7001-VI-046	12
1.8350 - 1.8743	46.610 - 47.609	7001-VI-047	12
1.8744 - 1.9137	47.610 - 48.609	7001-VI-048	12
1.9138 - 1.9530	48.610 - 49.609	7001-VI-049	12
1.9531 - 1.9924	49.610 - 50.609	7001-VI-050	12
1.9925 - 2.0318	50.610 - 51.609	7001-VI-051	12
2.0319 - 2.0712	51.610 - 52.609	7001-VI-052	12
2.0713 - 2.1105	52.610 - 53.609	7001-VI-053	12
2.1106 - 2.1499	53.610 - 54.609	7001-VI-054	12
2.1500 - 2.1893	54.610 - 55.609	7001-VI-055	12
2.1894 - 2.2286	55.610 - 56.609	7001-VI-056	12
2.2287 - 2.2680	56.610 - 57.609	7001-VI-057	12
2.2681 - 2.3074	57.610 - 58.609	7001-VI-058	12
2.3075 - 2.3468	58.610 - 59.609	7001-VI-059	12
2.3469 - 2.3858	59.610 - 60.609	7001-VI-060	12



C: 62 - 73 C: 12 - 13 C: 16 - 18 C: 54 - 61 C: 74

Replaceable Head Mandrels

Short Length | Cylindrical Shank | Diameter Range: 0.4646" - 2.3858" (11.800mm - 60.600mm)

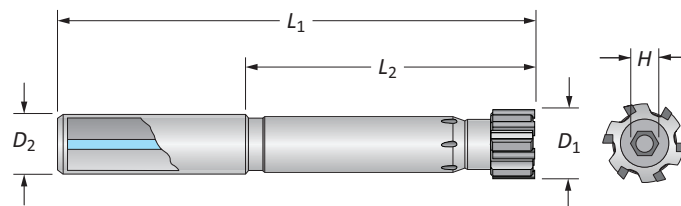
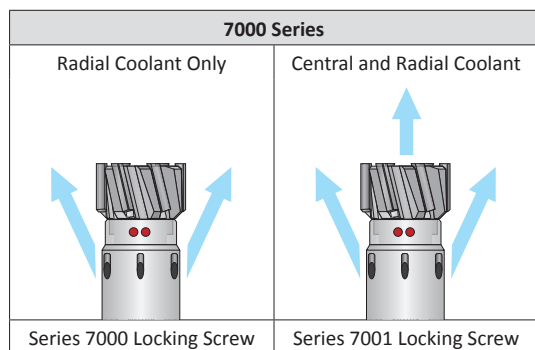

D_1 Range		Mandrel			No. of Teeth	Part No.
Imperial (in)	Metric (mm)	L_2	L_1	D_2		
0.4646 - 0.5751	11.800 - 14.609	50	95	12	6	7000-MC-001
0.5752 - 0.6932	14.610 - 17.609	65	113	16	6	7000-MC-002
0.6933 - 0.8507	17.610 - 21.609	75	125	20	6	7000-MC-003
0.8508 - 1.0475	21.610 - 26.609	85	135	20	6	7000-MC-004
1.0476 - 1.2838	26.610 - 32.609	105	161	25	6	7000-MC-005
1.2839 - 1.5987	32.610 - 40.609	120	180	32	6	7000-MC-006
1.5988 - 1.8170	40.610 - 45.609	120	180	32	6	7000-MC-007
1.8171 - 1.9924	45.610 - 50.600	120	180	32	8	7000-MC-075
1.9925 - 2.3858	50.610 - 60.600	120	190	40	8	7000-MC-008

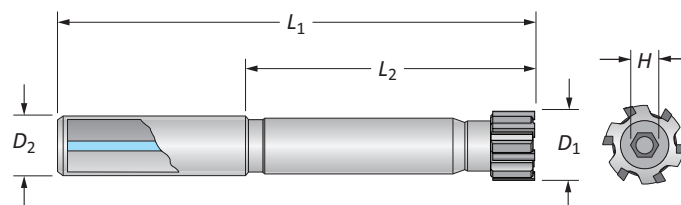
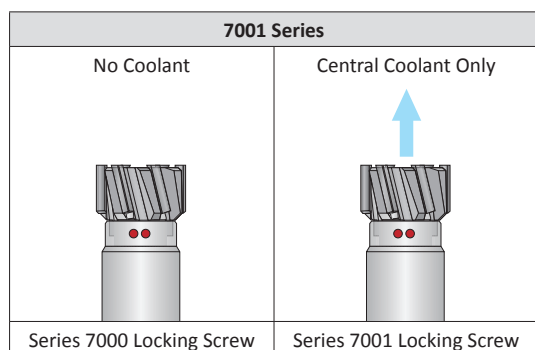

D_1 Range		Mandrel			No. of Teeth	Part No.
Imperial (in)	Metric (mm)	L_2	L_1	D_2		
0.4646 - 0.5751	11.800 - 14.609	50	95	12	6	7001-MC-001
0.5752 - 0.6932	14.610 - 17.609	65	113	16	6	7001-MC-002
0.6933 - 0.8507	17.610 - 21.609	75	125	20	6	7001-MC-003
0.8508 - 1.0475	21.610 - 26.609	85	135	20	6	7001-MC-004
1.0476 - 1.2838	26.610 - 32.609	105	161	25	6	7001-MC-005
1.2839 - 1.5987	32.610 - 40.609	120	180	32	6	7001-MC-006
1.5988 - 1.8170	40.610 - 45.609	120	180	32	6	7001-MC-007
1.8171 - 1.9924	45.610 - 50.600	120	180	32	8	7001-MC-075
1.9925 - 2.3858	50.610 - 60.600	120	190	40	8	7001-MC-008

C: 62 - 73

C: 12 - 13

C: 14 - 15

C: 54 - 61

C: 74

Key on C.1

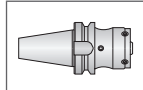
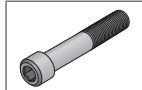
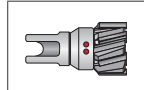
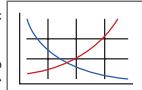

Application recommendation:

- Through hole application = radial coolant
- Blind hole application = central coolant

Replaceable Head Mandrels

Long Length | Cylindrical Shank | Diameter Range: 0.4646" - 2.3858" (11.800mm - 60.600mm)

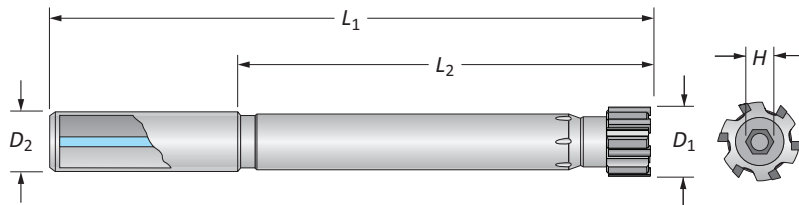
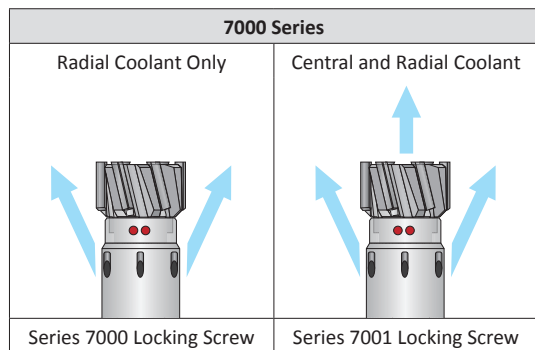

D ₁ Range		Mandrel			No. of Teeth	Part No.
Imperial (in)	Metric (mm)	L ₂	L ₁	D ₂		
0.4646 - 0.5751	11.800 - 14.609	95	140	12	6	7000-ML-001
0.5752 - 0.6932	14.610 - 17.609	105	153	16	6	7000-ML-002
0.6933 - 0.8507	17.610 - 21.609	125	175	20	6	7000-ML-003
0.8508 - 1.0475	21.610 - 26.609	145	195	20	6	7000-ML-004
1.0476 - 1.2838	26.610 - 32.609	165	221	25	6	7000-ML-005
1.2839 - 1.5987	32.610 - 40.609	185	245	32	6	7000-ML-006
1.5988 - 1.8170	40.610 - 45.609	185	245	32	6	7000-ML-007
1.8171 - 1.9924	45.610 - 50.600	185	245	32	8	7000-ML-075
1.9925 - 2.3858	50.610 - 60.600	185	255	40	8	7000-ML-008

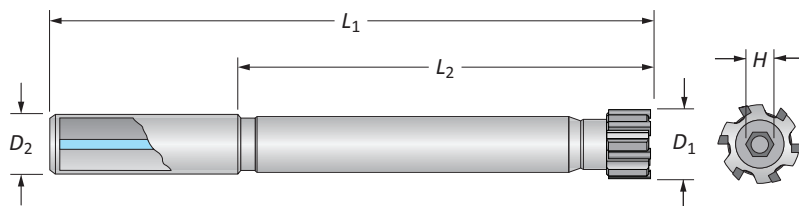
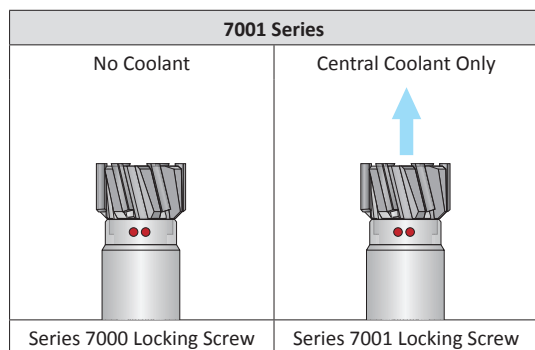

D ₁ Range		Mandrel			No. of Teeth	Part No.
Imperial (in)	Metric (mm)	L ₂	L ₁	D ₂		
0.4646 - 0.5751	11.800 - 14.609	95	140	12	6	7001-ML-001
0.5752 - 0.6932	14.610 - 17.609	105	153	16	6	7001-ML-002
0.6933 - 0.8507	17.610 - 21.609	125	175	20	6	7001-ML-003
0.8508 - 1.0475	21.610 - 26.609	145	195	20	6	7001-ML-004
1.0476 - 1.2838	26.610 - 32.609	165	221	25	6	7001-ML-005
1.2839 - 1.5987	32.610 - 40.609	185	245	32	6	7001-ML-006
1.5988 - 1.8170	40.610 - 45.609	185	245	32	6	7001-ML-007
1.8171 - 1.9924	45.610 - 50.600	185	245	32	8	7001-ML-075
1.9925 - 2.3858	50.610 - 60.600	185	255	40	8	7001-ML-008

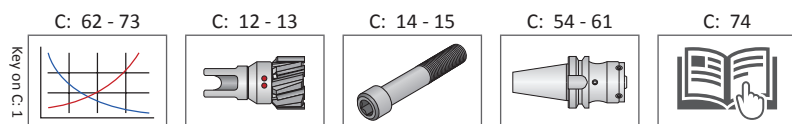

Application recommendation:

- Through hole application = radial coolant
- Blind hole application = central coolant

Replaceable Head Mandrels

Standard Length | Modular Shank | Diameter Range: 0.4646" - 2.3858" (11.800mm - 60.600mm)

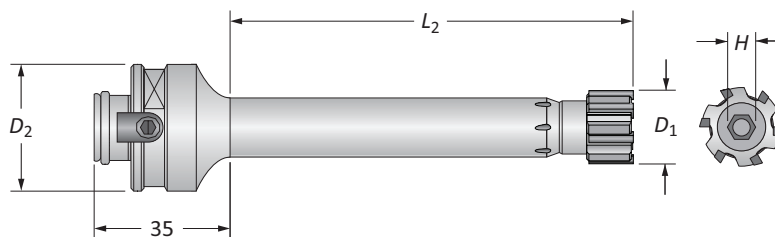
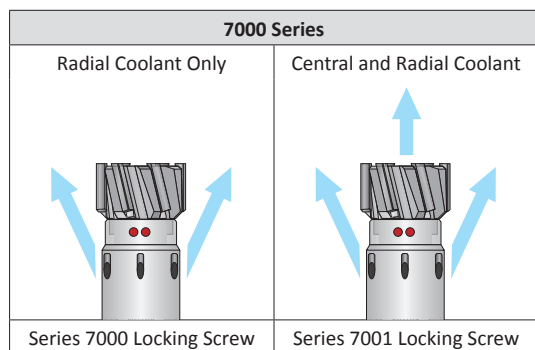

D_1 Range		Mandrel		No. of Teeth	Part No.
Imperial (in)	Metric (mm)	L_2	D_2		
0.4646 - 0.5751	11.800 - 14.609	65	50	6	7000-MM-001
0.5752 - 0.6932	14.610 - 17.609	80	50	6	7000-MM-002
0.6933 - 0.8507	17.610 - 21.609	90	50	6	7000-MM-003
0.8508 - 1.0475	21.610 - 26.609	100	50	6	7000-MM-004
1.0476 - 1.2838	26.610 - 32.609	110	50	6	7000-MM-005
1.2839 - 1.5987	32.610 - 40.609	120	50	6	7000-MM-006
1.5988 - 1.8170	40.610 - 45.609	120	50	6	7000-MM-007
1.8171 - 1.9924	45.610 - 50.600	120	50	8	7000-MM-075
1.9925 - 2.3858	50.610 - 60.600	120	50	8	7000-MM-008

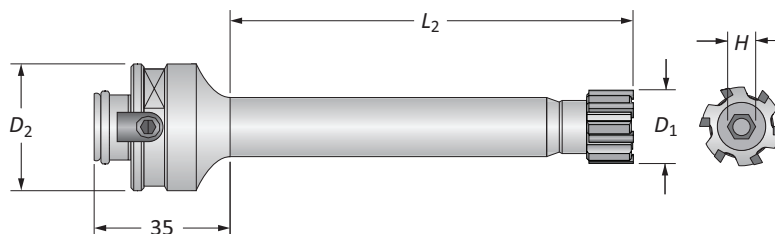
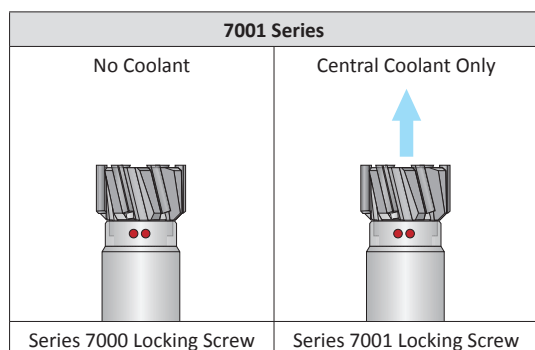

D_1 Range		Mandrel		No. of Teeth	Part No.
Imperial (in)	Metric (mm)	L_2	D_2		
0.4646 - 0.5751	11.800 - 14.609	65	50	6	7001-MM-001
0.5752 - 0.6932	14.610 - 17.609	80	50	6	7001-MM-002
0.6933 - 0.8507	17.610 - 21.609	90	50	6	7001-MM-003
0.8508 - 1.0475	21.610 - 26.609	100	50	6	7001-MM-004
1.0476 - 1.2838	26.610 - 32.609	110	50	6	7001-MM-005
1.2839 - 1.5987	32.610 - 40.609	120	50	6	7001-MM-006
1.5988 - 1.8170	40.610 - 45.609	120	50	6	7001-MM-007
1.8171 - 1.9924	45.610 - 50.600	120	50	8	7001-MM-075
1.9925 - 2.3858	50.610 - 60.600	120	50	8	7001-MM-008

C: 62 - 73

C: 12 - 13

C: 14 - 15

C: 54 - 61

C: 74

Key on C.1

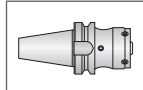
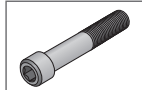
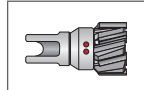
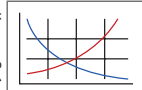

Application recommendation:

- Through hole application = radial coolant
- Blind hole application = central coolant

This page left intentionally blank

A

DRILLING

B

BORING

C

REAMING

D

BURNISHING

E

THREADING

X

SPECIALS

Monobloc Style Reamers

Product Overview

Monobloc Reamer Features

- Diameter range: 0.2283" - 1.2638" (5.80mm - 32.10mm)
- Available with straight or left hand helical flutes
- Expandable up to 1% of nominal diameter
- Available with cylindrical shanks only
- Work day lead time 20 - 25 days
- Available for recondition

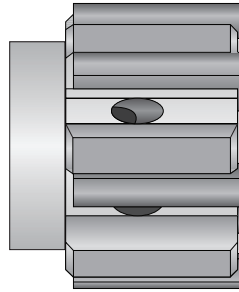

Straight Flute

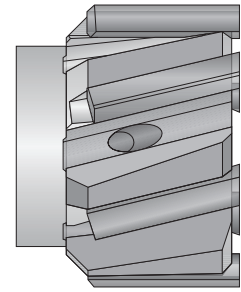

Left Hand Helical Flute



Uncoated



TiN Coated



TiAlN Coated



TiCN Coated



Alcrona Coated

Straight Flute - Through or Blind Holes

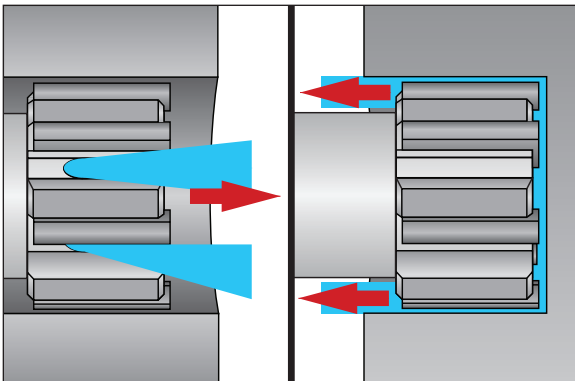

Use for either through hole or blind hole applications. The coolant flow determines the direction of the chip evacuation.

Left Hand Helical Flute - Through Holes Only

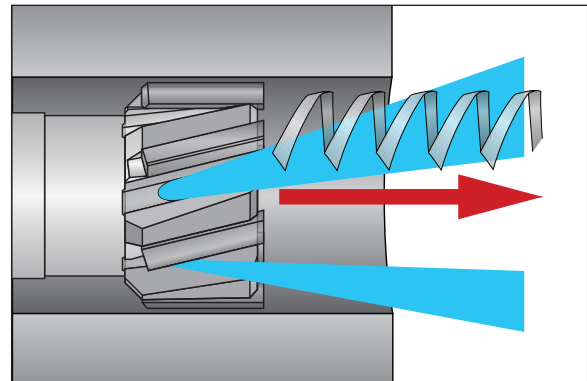

Use when reaming through hole applications. The cutting action of the helical flutes forces the chips forward for evacuation.

Product Nomenclature

Monobloc Style Reamers

I	9	2440	-	KL	E	-	006250	+	0000	-	0005
1	2	3		4	5		6		7		

NOTE: If diameter and tolerance are specified in inch units, put an "I" at the beginning of the item number

<p>1. Units of Measure</p> <p>Blank = Metric diameter I = Inch diameter</p>	<p>2. Shank Measure</p> <p>Blank = Metric 9 = Inch</p>	<p>3. Series</p> <p>2440 = Short length, straight flute - no coolant 2441 = Short length, straight flute - central coolant (blind holes) 3620 = Short length, straight flute - radial coolant (through holes) 3627 = Short length, helical flute - radial coolant (through holes)</p> <p>2430 = Long length, straight flute - no coolant 2431 = Long length, straight flute - central coolant (blind holes) 3610 = Long length, straight flute - radial coolant (through holes) 3617 = Long length, helical flute - radial coolant (through holes)</p>
<p>4. Coating and Substrate</p> <p>KL = Uncoated carbide SV = Uncoated cermet KN = TiN coated carbide SN = TiN coated cermet KC = TiCN coated carbide SC = TiCN coated cermet KA = TiAlN coated carbide SA = TiAlN coated cermet KK = Alcrona coated carbide SK = Alcrona coated cermet</p>	<p>5. Lead-in</p> <p>E, M = Left hand helical flute A, F, G, L, N, T, V = Straight flute J, W, X, Y = Straight flute with chipbreaker</p>	
<p>6. Diameter</p> <p>XX.XXXX = Imperial (inch) XXX.XXX = Metric (mm)</p>	<p>7. Tolerance*</p> <p>4 decimal places = inch tolerance 3 decimal places = mm tolerance</p> <p>*The total tolerance capable is 0.0002" (0.005mm)</p>	

Reference Key

Symbol	Attribute
D_1	Reamer diameter
D_2	Shank diameter
L_1	Overall length
L_2	Body length
L_{15}	Cutting edge length
H	Hex key

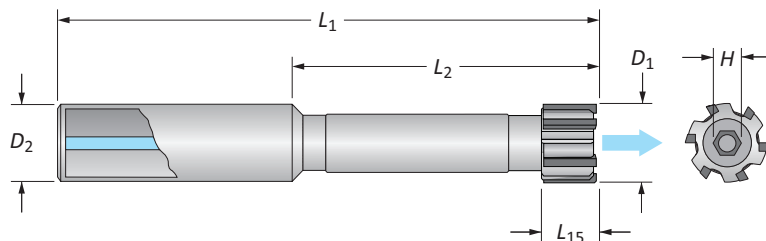

Monobloc Reamers

2440 Series | Short Length | Diameter Range: 0.2283" - 1.2638" (5.80mm - 32.10mm)

Series	2440
Flute	Straight
Type	Blind or Through Holes
Coolant	None

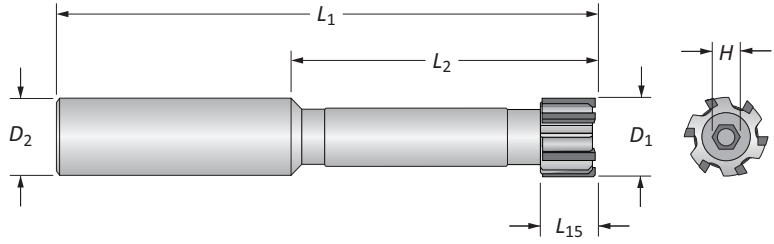

Inch Shank Part No. 92440-CGL-D ₁					Metric Shank Part No. 2440-CGL-D ₁					No. of Teeth	H (mm)
D ₁ Range	L ₁₅	L ₂	L ₁	D ₂	D ₁ Range	L ₁₅	L ₂	L ₁	D ₂		
0.2283 - 0.2598	0.315	1.575	3.150	0.500	5.80 - 6.60	8	40	80	12	4	2
0.2599 - 0.2992	0.315	1.575	3.150	0.500	6.61 - 7.60	8	40	80	12	4	2
0.2993 - 0.3386	0.394	1.575	3.150	0.500	7.61 - 8.60	10	40	80	12	4	2.5
0.3387 - 0.3780	0.394	1.969	3.543	0.500	8.61 - 9.60	10	50	90	12	4	2.5
0.3781 - 0.4173	0.394	1.969	3.740	0.500	9.61 - 10.60	10	50	95	12	6	3
0.4174 - 0.4567	0.394	2.362	4.134	0.500	10.61 - 11.60	10	60	105	12	6	3
0.4568 - 0.4961	0.394	2.362	4.134	0.500	11.61 - 12.60	10	60	105	12	6	3
0.4962 - 0.5354	0.394	2.362	4.134	0.500	12.61 - 13.60	10	60	105	12	6	4
0.5355 - 0.5748	0.394	2.362	4.528	0.500	13.61 - 14.60	10	70	115	12	6	4
0.5749 - 0.6142	0.394	2.362	4.528	0.500	14.61 - 15.60	10	70	115	12	6	4
0.6143 - 0.6535	0.394	3.150	5.118	0.625	15.61 - 16.60	10	80	130	16	6	4
0.6536 - 0.6929	0.394	3.150	5.118	0.625	16.61 - 17.60	10	80	130	16	6	5
0.6930 - 0.7323	0.472	3.543	5.512	0.625	17.61 - 18.60	12	90	140	16	6	5
0.7324 - 0.7520	0.472	3.543	5.906	0.750	18.61 - 19.10	12	90	150	20	6	5
0.7521 - 0.7913	0.472	3.937	6.229	0.750	19.11 - 20.10	12	100	160	20	6	5
0.7914 - 0.8307	0.472	3.937	6.229	0.750	20.11 - 21.10	12	100	160	20	6	5
0.8308 - 0.8701	0.472	3.937	6.229	0.750	21.11 - 22.10	12	100	160	20	6	6
0.8702 - 0.9094	0.472	3.937	6.229	0.750	22.11 - 23.10	12	100	160	20	6	6
0.9095 - 0.9488	0.472	3.937	6.229	0.750	23.11 - 24.10	12	100	160	20	6	6
0.9489 - 0.9882	0.472	3.937	6.229	0.750	24.11 - 25.10	12	100	160	20	6	6
0.9883 - 1.0276	0.472	4.331	6.693	1.000	25.11 - 26.10	16	110	170	25	6	6
1.0277 - 1.0669	0.551	4.331	6.693	1.000	26.11 - 27.10	16	110	170	25	6	6
1.0670 - 1.1063	0.551	4.331	6.693	1.000	27.11 - 28.10	16	110	170	25	6	8
1.1064 - 1.1457	0.551	4.331	6.693	1.000	28.11 - 29.10	16	110	170	25	6	8
1.1458 - 1.1850	0.551	4.331	6.693	1.000	29.11 - 30.10	16	110	170	25	6	8
1.1851 - 1.2244	0.551	4.331	6.693	1.000	30.11 - 31.10	16	110	170	25	6	8
1.2245 - 1.2638	0.551	4.331	6.693	1.000	31.11 - 32.10	16	110	170	25	6	8

"CG" Portion of Item No.

Grade	Uncoated	TiN	TiCN	TiAlN	Alcrona
Carbide	KL	KN	KC	KA	KK
Cermet	SV	SN	SC	SA	SK

"L" Portion of Item No.

ISO Material	T	F	N	G	L	A	V
P			●	●		○	○
S	●			○			
M				●	○		
H			○	●			
K	○			●			○
N				●		●	○

● Best ○ Better ○ Good

Ordering Example:

The customer needs the following:

- Metric shank
- Carbide
- TiN coating
- F lead-in
- 30.60mm diameter
- Blind hole
- Flood coolant

2440-KNF-030600

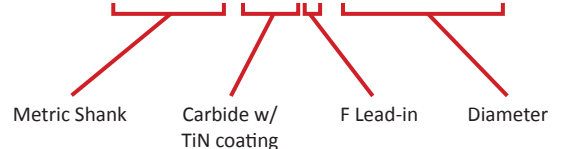

C: 62 - 73 C: 54 - 61 C: 75

Monobloc Reamers

2441 Series | Short Length | Diameter Range: 0.2283" - 1.2638" (5.80mm - 32.10mm)

Series	2441
Flute	Straight
Type	Blind Holes
Coolant	Central

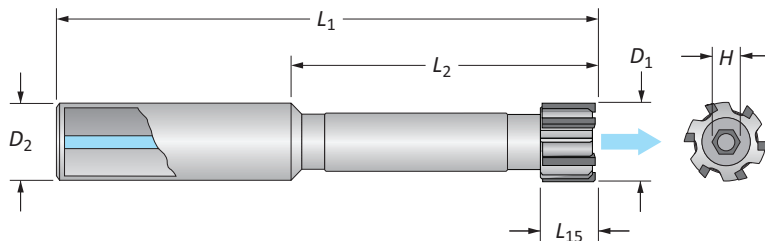

Inch Shank Part No. 92441-CGL-D ₁					Metric Shank Part No. 2441-CGL-D ₁					No. of Teeth	H (mm)
D ₁ Range	L ₁₅	L ₂	L ₁	D ₂	D ₁ Range	L ₁₅	L ₂	L ₁	D ₂		
0.2283 - 0.2598	0.315	1.575	3.071	0.500	5.80 - 6.60	8	40	80	12	4	2
0.2599 - 0.2992	0.315	1.575	3.071	0.500	6.61 - 7.60	8	40	80	12	4	2
0.2993 - 0.3386	0.394	1.575	3.071	0.500	7.61 - 8.60	10	40	80	12	4	2.5
0.3387 - 0.3780	0.394	1.969	3.465	0.500	8.61 - 9.60	10	50	90	12	4	2.5
0.3781 - 0.4173	0.394	1.969	3.740	0.500	9.61 - 10.60	10	50	95	12	6	3
0.4174 - 0.4567	0.394	1.969	3.740	0.500	10.61 - 11.60	10	60	105	12	6	3
0.4568 - 0.4961	0.394	1.969	3.740	0.500	11.61 - 12.60	10	60	105	12	6	3
0.4962 - 0.5354	0.394	1.969	3.740	0.500	12.61 - 13.60	10	60	105	12	6	4
0.5355 - 0.5748	0.394	1.969	3.740	0.500	13.61 - 14.60	10	70	115	12	6	4
0.5749 - 0.6142	0.394	1.969	3.740	0.500	14.61 - 15.60	10	70	115	12	6	4
0.6143 - 0.6535	0.394	1.969	3.937	0.625	15.61 - 16.60	10	80	130	16	6	4
0.6536 - 0.6929	0.394	1.969	3.937	0.625	16.61 - 17.60	10	80	130	16	6	5
0.6930 - 0.7323	0.472	1.969	3.937	0.625	17.61 - 18.60	12	90	140	16	6	5
0.7324 - 0.7520	0.472	2.362	4.724	0.750	18.61 - 19.10	12	90	150	20	6	5
0.7521 - 0.7913	0.472	2.362	4.724	0.750	19.11 - 20.10	12	100	160	20	6	5
0.7914 - 0.8307	0.472	2.362	4.724	0.750	20.11 - 21.10	12	100	160	20	6	5
0.8308 - 0.8701	0.472	2.362	4.724	0.750	21.11 - 22.10	12	100	160	20	6	6
0.8702 - 0.9094	0.472	2.362	4.724	0.750	22.11 - 23.10	12	100	160	20	6	6
0.9095 - 0.9488	0.472	2.362	4.724	0.750	23.11 - 24.10	12	100	160	20	6	6
0.9489 - 0.9882	0.472	2.362	4.724	0.750	24.11 - 25.10	12	100	160	20	6	6
0.9883 - 1.0276	0.472	2.953	5.315	1.000	25.11 - 26.10	16	110	170	25	6	6
1.0277 - 1.0669	0.551	2.953	5.315	1.000	26.11 - 27.10	16	110	170	25	6	6
1.0670 - 1.1063	0.551	2.953	5.315	1.000	27.11 - 28.10	16	110	170	25	6	8
1.1064 - 1.1457	0.551	2.953	5.315	1.000	28.11 - 29.10	16	110	170	25	6	8
1.1458 - 1.1850	0.551	2.953	5.315	1.000	29.11 - 30.10	16	110	170	25	6	8
1.1851 - 1.2244	0.551	2.953	5.315	1.000	30.11 - 31.10	16	110	170	25	6	8
1.2245 - 1.2638	0.551	2.953	5.315	1.000	31.11 - 32.10	16	110	170	25	6	8

"CG" Portion of Item No.

Grade	Uncoated	TiN	TiCN	TiAlN	Alcrona
Carbide	KL	KN	KC	KA	KK
Cermet	SV	SN	SC	SA	SK

"L" Portion of Item No.

ISO Material	T	F	N	G	L	A	V
P			●	●		○	○
S	●			○			
M				●	○		
H			○	●			
K	○			●			○
N				●		●	○

● Best ○ Better ○ Good

Ordering Example:

The customer needs the following:

- Metric shank
- Carbide
- TiN coating
- F lead-in
- 30.60mm diameter
- Blind hole

2441-KNF-030600

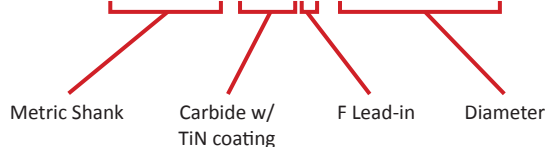

Key on C-1

C: 62 - 73

C: 54 - 61

C: 75

Monobloc Reamers

3620 Series | Short Length | Diameter Range: 0.2283" - 1.2638" (5.80mm - 32.10mm)

Series	3620
Flute	Straight
Type	Through Holes
Coolant	Radial

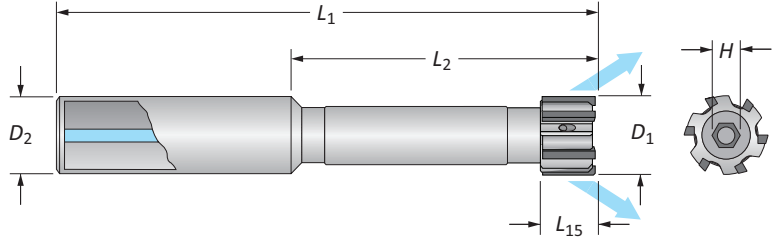

Inch Shank Part No. 93620-CGL-D ₁					Metric Shank Part No. 3620-CGL-D ₁					No. of Teeth	H (mm)
D ₁ Range	L ₁₅	L ₂	L ₁	D ₂	D ₁ Range	L ₁₅	L ₂	L ₁	D ₂		
0.2283 - 0.2598	0.315	1.575	3.071	0.500	5.80 - 6.60	8	40	78	12	4	2
0.2599 - 0.2992	0.315	1.575	3.071	0.500	6.61 - 7.60	8	40	78	12	4	2
0.2993 - 0.3386	0.394	1.575	3.071	0.500	7.61 - 8.60	10	40	78	12	4	2.5
0.3387 - 0.3780	0.394	1.969	3.465	0.500	8.61 - 9.60	10	50	88	12	4	2.5
0.3781 - 0.4173	0.394	1.969	3.740	0.500	9.61 - 10.60	10	50	95	12	6	3
0.4174 - 0.4567	0.394	1.969	3.740	0.500	10.61 - 11.60	10	50	95	12	6	3
0.4568 - 0.4961	0.394	1.969	3.740	0.500	11.61 - 12.60	10	50	95	12	6	3
0.4962 - 0.5354	0.394	1.969	3.740	0.500	12.61 - 13.60	10	50	95	12	6	4
0.5355 - 0.5748	0.394	1.969	3.740	0.500	13.61 - 14.60	10	50	95	12	6	4
0.5749 - 0.6142	0.394	1.969	3.740	0.500	14.61 - 15.60	10	50	95	12	6	4
0.6143 - 0.6535	0.394	1.969	3.937	0.625	15.61 - 16.60	10	50	100	16	6	4
0.6536 - 0.6929	0.394	1.969	3.937	0.625	16.61 - 17.60	10	50	100	16	6	5
0.6930 - 0.7323	0.472	1.969	3.937	0.625	17.61 - 18.60	12	50	100	16	6	5
0.7324 - 0.7520	0.472	2.362	4.724	0.750	18.61 - 19.10	12	60	120	20	6	5
0.7521 - 0.7913	0.472	2.362	4.724	0.750	19.11 - 20.10	12	60	120	20	6	5
0.7914 - 0.8307	0.472	2.362	4.724	0.750	20.11 - 21.10	12	60	120	20	6	5
0.8308 - 0.8701	0.472	2.362	4.724	0.750	21.11 - 22.10	12	60	120	20	6	6
0.8702 - 0.9094	0.472	2.362	4.724	0.750	22.11 - 23.10	12	60	120	20	6	6
0.9095 - 0.9488	0.472	2.362	4.724	0.750	23.11 - 24.10	12	60	120	20	6	6
0.9489 - 0.9882	0.472	2.362	4.724	0.750	24.11 - 25.10	12	60	120	20	6	6
0.9883 - 1.0276	0.472	2.953	5.315	1.000	25.11 - 26.10	16	70	135	25	6	6
1.0277 - 1.0669	0.551	2.953	5.315	1.000	26.11 - 27.10	16	70	135	25	6	6
1.0670 - 1.1063	0.551	2.953	5.315	1.000	27.11 - 28.10	16	70	135	25	6	8
1.1064 - 1.1457	0.551	2.953	5.315	1.000	28.11 - 29.10	16	70	135	25	6	8
1.1458 - 1.1850	0.551	2.953	5.315	1.000	29.11 - 30.10	16	70	135	25	6	8
1.1851 - 1.2244	0.551	2.953	5.315	1.000	30.11 - 31.10	16	70	135	25	6	8
1.2245 - 1.2638	0.551	2.953	5.315	1.000	31.11 - 32.10	16	70	135	25	6	8

"CG" Portion of Item No.

Grade	Uncoated	TiN	TiCN	TiAlN	Alcrona
Carbide	KL	KN	KC	KA	KK
Cermet	SV	SN	SC	SA	SK

"L" Portion of Item No.

ISO Material	T	F	N	G	L	A	V
P			●	●		○	○
S	●			○			
M				●	○		
H			○	●			
K	○			●			○
N				●		●	○

● Best ○ Better ○ Good

Ordering Example:

The customer needs the following:

- Metric shank
- Carbide
- TiN coating
- F lead-in
- 30.60mm diameter
- Through hole

3620-KNF-030600

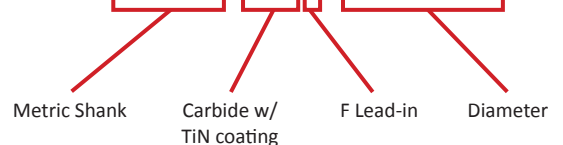

C: 62 - 73 C: 54 - 61 C: 75

Monobloc Reamers

3627 Series | Short Length | Diameter Range: 0.2283" - 1.2638" (5.80mm - 32.10mm)

Series	3627
Flute	Helical
Type	Through Holes
Coolant	Radial

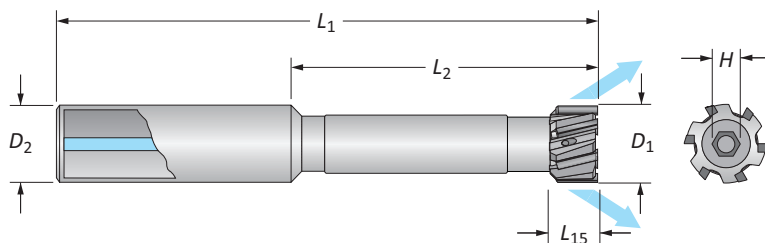

Inch Shank Part No. 93627-CGL-D ₁					Metric Shank Part No. 3627-CGL-D ₁					No. of Teeth	H (mm)
D ₁ Range	L ₁₅	L ₂	L ₁	D ₂	D ₁ Range	L ₁₅	L ₂	L ₁	D ₂		
0.2283 - 0.2598	0.315	1.575	3.150	0.500	5.80 - 6.60	8	40	80	12	4	2
0.2599 - 0.2992	0.315	1.575	3.150	0.500	6.61 - 7.60	8	40	80	12	4	2
0.2993 - 0.3386	0.394	1.575	3.150	0.500	7.61 - 8.60	10	40	80	12	4	2.5
0.3387 - 0.3780	0.394	1.969	3.543	0.500	8.61 - 9.60	10	50	90	12	4	2.5
0.3781 - 0.4173	0.394	1.969	3.740	0.500	9.61 - 10.60	10	50	95	12	6	3
0.4174 - 0.4567	0.394	2.362	4.134	0.500	10.61 - 11.60	10	60	105	12	6	3
0.4568 - 0.4961	0.394	2.362	4.134	0.500	11.61 - 12.60	10	60	105	12	6	3
0.4962 - 0.5354	0.394	2.362	4.134	0.500	12.61 - 13.60	10	60	105	12	6	4
0.5355 - 0.5748	0.394	2.756	4.528	0.500	13.61 - 14.60	10	70	115	12	6	4
0.5749 - 0.6142	0.394	2.756	4.528	0.500	14.61 - 15.60	10	70	115	12	6	4
0.6143 - 0.6535	0.394	3.150	5.118	0.625	15.61 - 16.60	10	80	130	16	6	4
0.6536 - 0.6929	0.394	3.150	5.118	0.625	16.61 - 17.60	10	80	130	16	6	5
0.6930 - 0.7323	0.472	3.543	5.512	0.625	17.61 - 18.60	12	90	140	16	6	5
0.7324 - 0.7520	0.472	3.543	5.906	0.750	18.61 - 19.10	12	90	150	20	6	5
0.7521 - 0.7913	0.472	3.937	6.299	0.750	19.11 - 20.10	12	100	160	20	6	5
0.7914 - 0.8307	0.472	3.937	6.299	0.750	20.11 - 21.10	12	100	160	20	6	5
0.8308 - 0.8701	0.472	3.937	6.299	0.750	21.11 - 22.10	12	100	160	20	6	6
0.8702 - 0.9094	0.472	3.937	6.299	0.750	22.11 - 23.10	12	100	160	20	6	6
0.9095 - 0.9488	0.472	3.937	6.299	0.750	23.11 - 24.10	12	100	160	20	6	6
0.9489 - 0.9882	0.472	3.937	6.299	0.750	24.11 - 25.10	12	100	160	20	6	6
0.9883 - 1.0276	0.472	4.331	6.693	1.000	25.11 - 26.10	16	110	170	25	6	6
1.0277 - 1.0669	0.551	4.331	6.693	1.000	26.11 - 27.10	16	110	170	25	6	6
1.0670 - 1.1063	0.551	4.331	6.693	1.000	27.11 - 28.10	16	110	170	25	6	8
1.1064 - 1.1457	0.551	4.331	6.693	1.000	28.11 - 29.10	16	110	170	25	6	8
1.1458 - 1.1850	0.551	4.331	6.693	1.000	29.11 - 30.10	16	110	170	25	6	8
1.1851 - 1.2244	0.551	4.331	6.693	1.000	30.11 - 31.10	16	110	170	25	6	8
1.2245 - 1.2638	0.551	4.331	6.693	1.000	31.11 - 32.10	16	110	170	25	6	8

"CG" Portion of Item No.

Grade	Uncoated	TiN	TiCN	TiAlN	Alcrona
Carbide	KL	KN	KC	KA	KK
Cermet	SV	SN	SC	SA	SK

"L" Portion of Item No.

ISO Material	T	F	N	G	L	A	V
P			●	●		○	○
S	●			○			
M				●	○		
H			○	●			
K	○			●			○
N				●		●	○

● Best ○ Better ○ Good

Ordering Example:

The customer needs the following:

- Metric shank
- Carbide
- TiN coating
- F lead-in
- 30.60mm diameter
- Through hole

3627-KNF-030600

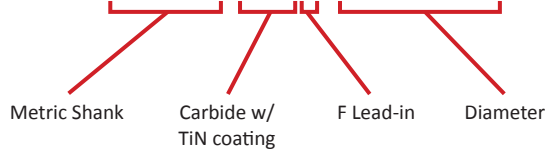

Key on C-1

C: 62 - 73

C: 54 - 61

C: 75

Monobloc Reamers

2430 Series | Long length | Diameter range: 0.2283" - 1.2638" (5.80mm - 32.10mm)

Series	2430
Flute	Straight
Type	Blind or Through Holes
Coolant	None

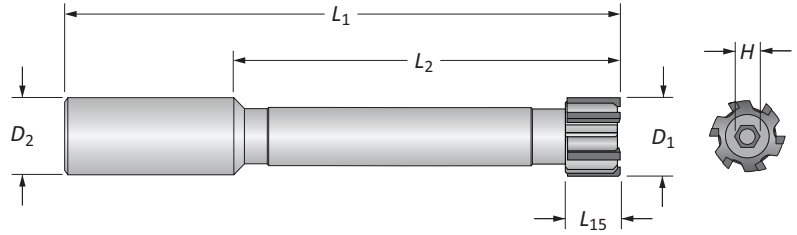

Inch Shank Part No. 92430-CGL-D ₁					Metric Shank Part No. 2430-CGL-D ₁					No. of Teeth	H (mm)
D ₁ Range	L ₁₅	L ₂	L ₁	D ₂	D ₁ Range	L ₁₅	L ₂	L ₁	D ₂		
0.2283 - 0.2598	0.315	3.346	4.843	0.500	5.80 - 6.60	8	85	123	12	4	2
0.2599 - 0.2992	0.315	3.346	4.843	0.500	6.61 - 7.60	8	85	123	12	4	2
0.2993 - 0.3386	0.394	3.346	4.843	0.500	7.61 - 8.60	10	85	123	12	4	2.5
0.3387 - 0.3780	0.394	3.346	4.843	0.500	8.61 - 9.60	10	85	123	12	4	2.5
0.3781 - 0.4173	0.394	4.528	6.299	0.500	9.61 - 10.60	10	115	160	12	6	3
0.4174 - 0.4567	0.394	4.528	6.299	0.500	10.61 - 11.60	10	115	160	12	6	3
0.4568 - 0.4961	0.394	4.528	6.299	0.500	11.61 - 12.60	10	115	160	12	6	3
0.4962 - 0.5354	0.394	4.528	6.299	0.500	12.61 - 13.60	10	115	160	12	6	4
0.5355 - 0.5748	0.394	4.528	6.299	0.500	13.61 - 14.60	10	115	160	12	6	4
0.5749 - 0.6142	0.394	4.528	6.299	0.500	14.61 - 15.60	10	115	160	12	6	4
0.6143 - 0.6535	0.394	5.118	7.087	0.625	15.61 - 16.60	10	130	180	16	6	4
0.6536 - 0.6929	0.394	5.118	7.087	0.625	16.61 - 17.60	10	130	180	16	6	5
0.6930 - 0.7323	0.472	5.118	7.087	0.625	17.61 - 18.60	12	130	180	16	6	5
0.7324 - 0.7520	0.472	5.512	7.874	0.750	18.61 - 19.10	12	140	200	20	6	5
0.7521 - 0.7913	0.472	5.512	7.874	0.750	19.11 - 20.10	12	140	200	20	6	5
0.7914 - 0.8307	0.472	5.512	7.874	0.750	20.11 - 21.10	12	140	200	20	6	5
0.8308 - 0.8701	0.472	5.512	7.874	0.750	21.11 - 22.10	12	140	200	20	6	6
0.8702 - 0.9094	0.472	5.512	7.874	0.750	22.11 - 23.10	12	140	200	20	6	6
0.9095 - 0.9488	0.472	5.512	7.874	0.750	23.11 - 24.10	12	140	200	20	6	6
0.9489 - 0.9882	0.472	5.512	7.874	0.750	24.11 - 25.10	12	140	200	20	6	6
0.9883 - 1.0276	0.472	5.906	8.268	1.000	25.11 - 26.10	16	150	210	25	6	6
1.0277 - 1.0669	0.551	5.906	8.268	1.000	26.11 - 27.10	16	150	210	25	6	6
1.0670 - 1.1063	0.551	5.906	8.268	1.000	27.11 - 28.10	16	150	210	25	6	8
1.1064 - 1.1457	0.551	5.906	8.268	1.000	28.11 - 29.10	16	150	210	25	6	8
1.1458 - 1.1850	0.551	5.906	8.268	1.000	29.11 - 30.10	16	150	210	25	6	8
1.1851 - 1.2244	0.551	5.906	8.268	1.000	30.11 - 31.10	16	150	210	25	6	8
1.2245 - 1.2638	0.551	5.906	8.268	1.000	31.11 - 32.10	16	150	210	25	6	8

"CG" Portion of Item No.

Grade	Uncoated	TiN	TiCN	TiAlN	Alcrona
Carbide	KL	KN	KC	KA	KK
Cermet	SV	SN	SC	SA	SK

"L" Portion of Item No.

ISO Material	T	F	N	G	L	A	V
P			●	●		○	○
S	●			○			
M				●	○		
H			○	●			
K	○			●			○
N				●		●	○

● Best ○ Better ○ Good

Ordering Example:

The customer needs the following:

- Metric shank
- Carbide
- TiN coating
- F lead-in
- 30.60mm diameter
- Blind hole
- Flood coolant

2430-KNF-030600

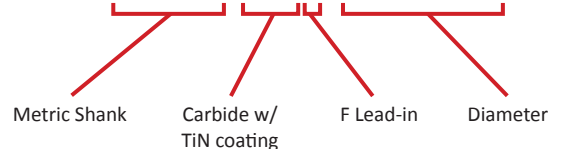

C: 62 - 73 C: 54 - 61 C: 75

Monobloc Reamers

2431 Series | Long Length | Diameter Range: 0.2283" - 1.2638" (5.80mm - 32.10mm)

Series	2431
Flute	Straight
Type	Blind Holes
Coolant	Central

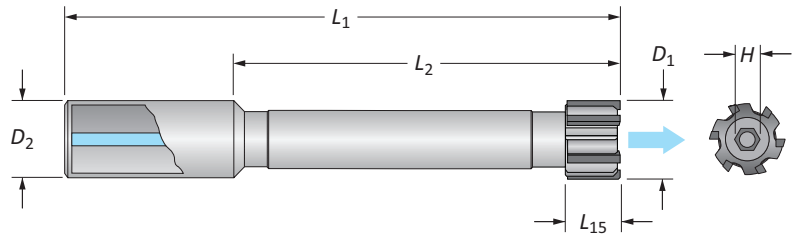

Inch Shank Part No. 92431-CGL-D ₁					Metric Shank Part No. 2431-CGL-D ₁					No. of Teeth	H (mm)
D ₁ Range	L ₁₅	L ₂	L ₁	D ₂	D ₁ Range	L ₁₅	L ₂	L ₁	D ₂		
0.2283 - 0.2598	0.315	3.346	4.843	0.500	5.80 - 6.60	8	85	123	12	4	2
0.2599 - 0.2992	0.315	3.346	4.843	0.500	6.61 - 7.60	8	85	123	12	4	2
0.2993 - 0.3386	0.394	3.346	4.843	0.500	7.61 - 8.60	10	85	123	12	4	2.5
0.3387 - 0.3780	0.394	3.346	4.843	0.500	8.61 - 9.60	10	85	123	12	4	2.5
0.3781 - 0.4173	0.394	4.528	6.299	0.500	9.61 - 10.60	10	115	160	12	6	3
0.4174 - 0.4567	0.394	4.528	6.299	0.500	10.61 - 11.60	10	115	160	12	6	3
0.4568 - 0.4961	0.394	4.528	6.299	0.500	11.61 - 12.60	10	115	160	12	6	3
0.4962 - 0.5354	0.394	4.528	6.299	0.500	12.61 - 13.60	10	115	160	12	6	4
0.5355 - 0.5748	0.394	4.528	6.299	0.500	13.61 - 14.60	10	115	160	12	6	4
0.5749 - 0.6142	0.394	4.528	6.299	0.500	14.61 - 15.60	10	115	160	12	6	4
0.6143 - 0.6535	0.394	5.118	7.087	0.625	15.61 - 16.60	10	130	180	16	6	4
0.6536 - 0.6929	0.394	5.118	7.087	0.625	16.61 - 17.60	10	130	180	16	6	5
0.6930 - 0.7323	0.472	5.118	7.087	0.625	17.61 - 18.60	12	130	180	16	6	5
0.7324 - 0.7520	0.472	5.512	7.874	0.750	18.61 - 19.10	12	140	200	20	6	5
0.7521 - 0.7913	0.472	5.512	7.874	0.750	19.11 - 20.10	12	140	200	20	6	5
0.7914 - 0.8307	0.472	5.512	7.874	0.750	20.11 - 21.10	12	140	200	20	6	5
0.8308 - 0.8701	0.472	5.512	7.874	0.750	21.11 - 22.10	12	140	200	20	6	6
0.8702 - 0.9094	0.472	5.512	7.874	0.750	22.11 - 23.10	12	140	200	20	6	6
0.9095 - 0.9488	0.472	5.512	7.874	0.750	23.11 - 24.10	12	140	200	20	6	6
0.9489 - 0.9882	0.472	5.512	7.874	0.750	24.11 - 25.10	12	140	200	20	6	6
0.9883 - 1.0276	0.472	5.906	8.268	1.000	25.11 - 26.10	16	150	210	25	6	6
1.0277 - 1.0669	0.551	5.906	8.268	1.000	26.11 - 27.10	16	150	210	25	6	6
1.0670 - 1.1063	0.551	5.906	8.268	1.000	27.11 - 28.10	16	150	210	25	6	8
1.1064 - 1.1457	0.551	5.906	8.268	1.000	28.11 - 29.10	16	150	210	25	6	8
1.1458 - 1.1850	0.551	5.906	8.268	1.000	29.11 - 30.10	16	150	210	25	6	8
1.1851 - 1.2244	0.551	5.906	8.268	1.000	30.11 - 31.10	16	150	210	25	6	8
1.2245 - 1.2638	0.551	5.906	8.268	1.000	31.11 - 32.10	16	150	210	25	6	8

“CG” Portion of Item No.

Grade	Uncoated	TiN	TiCN	TiAlN	Alcrona
Carbide	KL	KN	KC	KA	KK
Cermet	SV	SN	SC	SA	SK

“L” Portion of Item No.

ISO Material	T	F	N	G	L	A	V
P			●	●		○	○
S	●			○			
M				●	○		
H			○	●			
K	○			●			○
N				●		●	○

● Best ○ Better ○ Good

Ordering Example:

The customer needs the following:

- Metric shank
- Carbide
- TiN coating
- F lead-in
- 30.60mm diameter
- Blind hole

2431-KNF-030600

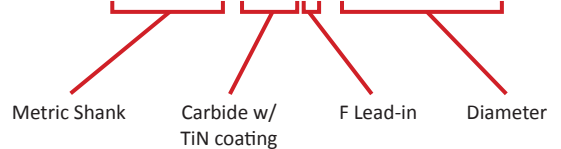

Key on C-1

C: 62 - 73 C: 54 - 61 C: 75

Monobloc Reamers

3610 Series | Long Length | Diameter Range: 0.2283" - 1.2638" (5.80mm - 32.10mm)

Series	3610
Flute	Straight
Type	Through Holes
Coolant	Radial

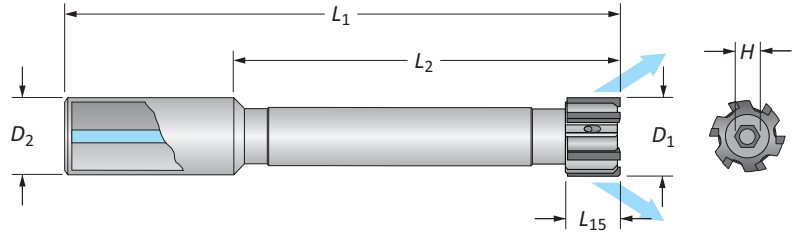

Inch Shank Part No. 93610-CGL-D ₁					Metric Shank Part No. 3610-CGL-D ₁					No. of Teeth	H (mm)
D ₁ Range	L ₁₅	L ₂	L ₁	D ₂	D ₁ Range	L ₁₅	L ₂	L ₁	D ₂		
0.2283 - 0.2598	0.315	3.346	4.843	0.500	5.80 - 6.60	8	85	123	12	4	2
0.2599 - 0.2992	0.315	3.346	4.843	0.500	6.61 - 7.60	8	85	123	12	4	2
0.2993 - 0.3386	0.394	3.346	4.843	0.500	7.61 - 8.60	10	85	123	12	4	2.5
0.3387 - 0.3780	0.394	3.346	4.843	0.500	8.61 - 9.60	10	85	123	12	4	2.5
0.3781 - 0.4173	0.394	4.528	6.299	0.500	9.61 - 10.60	10	115	160	12	6	3
0.4174 - 0.4567	0.394	4.528	6.299	0.500	10.61 - 11.60	10	115	160	12	6	3
0.4568 - 0.4961	0.394	4.528	6.299	0.500	11.61 - 12.60	10	115	160	12	6	3
0.4962 - 0.5354	0.394	4.528	6.299	0.500	12.61 - 13.60	10	115	160	12	6	4
0.5355 - 0.5748	0.394	4.528	6.299	0.500	13.61 - 14.60	10	115	160	12	6	4
0.5749 - 0.6142	0.394	4.528	6.299	0.500	14.61 - 15.60	10	115	160	12	6	4
0.6143 - 0.6535	0.394	5.118	7.087	0.625	15.61 - 16.60	10	130	180	16	6	4
0.6536 - 0.6929	0.394	5.118	7.087	0.625	16.61 - 17.60	10	130	180	16	6	5
0.6930 - 0.7323	0.472	5.118	7.087	0.625	17.61 - 18.60	12	130	180	16	6	5
0.7324 - 0.7520	0.472	5.512	7.874	0.750	18.61 - 19.10	12	140	200	20	6	5
0.7521 - 0.7913	0.472	5.512	7.874	0.750	19.11 - 20.10	12	140	200	20	6	5
0.7914 - 0.8307	0.472	5.512	7.874	0.750	20.11 - 21.10	12	140	200	20	6	5
0.8308 - 0.8701	0.472	5.512	7.874	0.750	21.11 - 22.10	12	140	200	20	6	6
0.8702 - 0.9094	0.472	5.512	7.874	0.750	22.11 - 23.10	12	140	200	20	6	6
0.9095 - 0.9488	0.472	5.512	7.874	0.750	23.11 - 24.10	12	140	200	20	6	6
0.9489 - 0.9882	0.472	5.512	7.874	0.750	24.11 - 25.10	12	140	200	20	6	6
0.9883 - 1.0276	0.472	5.906	8.268	1.000	25.11 - 26.10	16	150	210	25	6	6
1.0277 - 1.0669	0.551	5.906	8.268	1.000	26.11 - 27.10	16	150	210	25	6	6
1.0670 - 1.1063	0.551	5.906	8.268	1.000	27.11 - 28.10	16	150	210	25	6	8
1.1064 - 1.1457	0.551	5.906	8.268	1.000	28.11 - 29.10	16	150	210	25	6	8
1.1458 - 1.1850	0.551	5.906	8.268	1.000	29.11 - 30.10	16	150	210	25	6	8
1.1851 - 1.2244	0.551	5.906	8.268	1.000	30.11 - 31.10	16	150	210	25	6	8
1.2245 - 1.2638	0.551	5.906	8.268	1.000	31.11 - 32.10	16	150	210	25	6	8

"CG" Portion of Item No.

Grade	Uncoated	TiN	TiCN	TiAlN	Alcrona
Carbide	KL	KN	KC	KA	KK
Cermet	SV	SN	SC	SA	SK

"L" Portion of Item No.

ISO Material	T	F	N	G	L	A	V
P			●	●		○	○
S	●			○			
M				●	○		
H			○	●			
K	○			●			○
N				●		●	○

● Best ○ Better ○ Good

Ordering Example:

The customer needs the following:

- Metric shank
- Carbide
- TiN coating
- F lead-in
- 30.60mm diameter
- Through hole

3610-KNF-030600

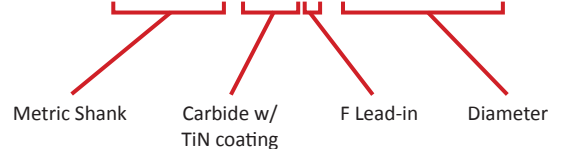

Key on C: 1

C: 62 - 73

C: 54 - 61

C: 75

Monobloc Reamers

3617 Series | Long Length | Diameter Range: 0.2283" - 1.2638" (5.80mm - 32.10mm)

Series	3617
Flute	Helical
Type	Through Holes
Coolant	Radial

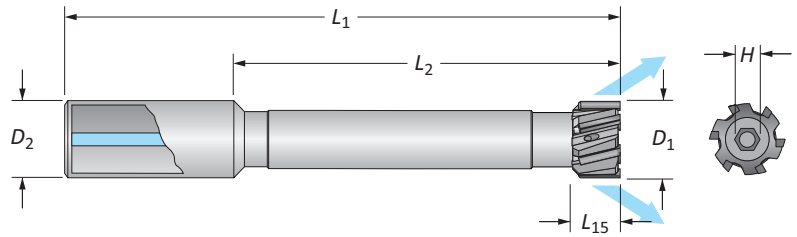

Inch Shank Part No. 93617-CGL-D ₁					Metric Shank Part No. 3617-CGL-D ₁					No. of Teeth	H (mm)
D ₁ Range	L ₁₅	L ₂	L ₁	D ₂	D ₁ Range	L ₁₅	L ₂	L ₁	D ₂		
0.2283 - 0.2598	0.315	3.346	4.843	0.500	5.80 - 6.60	8	85	123	12	4	2
0.2599 - 0.2992	0.315	3.346	4.843	0.500	6.61 - 7.60	8	85	123	12	4	2
0.2993 - 0.3386	0.394	3.346	4.843	0.500	7.61 - 8.60	10	85	123	12	4	2.5
0.3387 - 0.3780	0.394	3.346	4.843	0.500	8.61 - 9.60	10	85	123	12	4	2.5
0.3781 - 0.4173	0.394	4.528	6.299	0.500	9.61 - 10.60	10	115	160	12	6	3
0.4174 - 0.4567	0.394	4.528	6.299	0.500	10.61 - 11.60	10	115	160	12	6	3
0.4568 - 0.4961	0.394	4.528	6.299	0.500	11.61 - 12.60	10	115	160	12	6	3
0.4962 - 0.5354	0.394	4.528	6.299	0.500	12.61 - 13.60	10	115	160	12	6	4
0.5355 - 0.5748	0.394	4.528	6.299	0.500	13.61 - 14.60	10	115	160	12	6	4
0.5749 - 0.6142	0.394	4.528	6.299	0.500	14.61 - 15.60	10	115	160	12	6	4
0.6143 - 0.6535	0.394	5.118	7.087	0.625	15.61 - 16.60	10	130	180	16	6	4
0.6536 - 0.6929	0.394	5.118	7.087	0.625	16.61 - 17.60	10	130	180	16	6	5
0.6930 - 0.7323	0.472	5.118	7.087	0.625	17.61 - 18.60	12	130	180	16	6	5
0.7324 - 0.7520	0.472	5.512	7.874	0.750	18.61 - 19.10	12	140	200	20	6	5
0.7521 - 0.7913	0.472	5.512	7.874	0.750	19.11 - 20.10	12	140	200	20	6	5
0.7914 - 0.8307	0.472	5.512	7.874	0.750	20.11 - 21.10	12	140	200	20	6	5
0.8308 - 0.8701	0.472	5.512	7.874	0.750	21.11 - 22.10	12	140	200	20	6	6
0.8702 - 0.9094	0.472	5.512	7.874	0.750	22.11 - 23.10	12	140	200	20	6	6
0.9095 - 0.9488	0.472	5.512	7.874	0.750	23.11 - 24.10	12	140	200	20	6	6
0.9489 - 0.9882	0.472	5.512	7.874	0.750	24.11 - 25.10	12	140	200	20	6	6
0.9883 - 1.0276	0.472	5.906	8.268	1.000	25.11 - 26.10	16	150	210	25	6	6
1.0277 - 1.0669	0.551	5.906	8.268	1.000	26.11 - 27.10	16	150	210	25	6	6
1.0670 - 1.1063	0.551	5.906	8.268	1.000	27.11 - 28.10	16	150	210	25	6	8
1.1064 - 1.1457	0.551	5.906	8.268	1.000	28.11 - 29.10	16	150	210	25	6	8
1.1458 - 1.1850	0.551	5.906	8.268	1.000	29.11 - 30.10	16	150	210	25	6	8
1.1851 - 1.2244	0.551	5.906	8.268	1.000	30.11 - 31.10	16	150	210	25	6	8
1.2245 - 1.2638	0.551	5.906	8.268	1.000	31.11 - 32.10	16	150	210	25	6	8

"CG" Portion of Item No.

Grade	Uncoated	TiN	TiCN	TiAlN	Alcrona
Carbide	KL	KN	KC	KA	KK
Cermet	SV	SN	SC	SA	SK

"L" Portion of Item No.

ISO Material	T	F	N	G	L	A	V
P			●	●		○	○
S	●			○			
M				●	○		
H			○	●			
K	○			●			○
N				●		●	○

● Best ○ Better ○ Good

Ordering Example:

The customer needs the following:

- Metric shank
- Carbide
- TiN coating
- F lead-in
- 30.60mm diameter
- Through hole

3617-KNF-030600

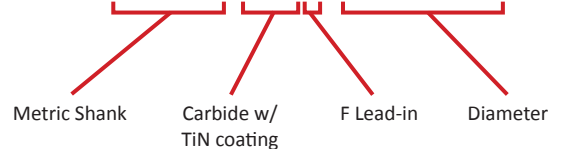

Key on C-1

C: 62 - 73

C: 54 - 61

C: 75

Radial Adjusting Adapters

Collet Chuck Adapters

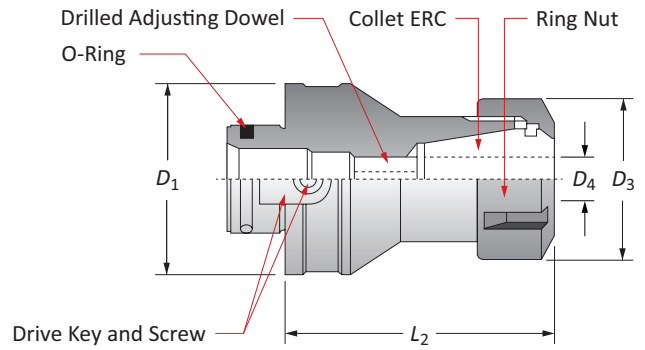

Collet Sleeve Size*	Adapter				Part No.	Spare Parts					
	D_1	D_3	D_4	L_2		Clamping Screw	Ring Nut	Adjusting Dowel	Drive Key	Ring Nut Wrench	Adjusting Dowel Key
ERC25	42	50	0.5 - 16mm	70	30.50R.25.70	M4x8V	G25S	M12x16GF	TAB3924	CH25S	6mm
ERC32	50	50	1 - 20mm	70	30.50R.32.70	M4x8V	G32S	M16x15x18GF	TAB3924	CH32S	8mm
ERC32	50	63	1 - 20mm	90	30.63R.32.90	M6x12V	G32S	M12x16GF	TAB3923.1	CH32S	6mm
ERC40	63	63	2 - 30mm	90	30.63R.40.90	M6x12V	G40S	M20x2x20GF	TAB3923.1	CH40S	10mm
ERC32	50	80	1 - 20mm	90	30.80R.32.90	M6x16V	G32S	M12x16GF	TAB3923.2	CH32S	6mm
ERC40	63	80	2 - 30mm	90	30.80R.40.90	M6x16V	G40S	M20x2x20GF	TAB3923.2	CH40S	10mm

*Collet sleeve not included

Reference Key

Symbol	Attribute
D_1	Modular shank size
D_3	Body diameter
D_4	Shank diameter
L_2	Gage length

C: 55



Modular System courtesy of 

A DRILLING
B BORING
C REAMING
D BURNISHING
E THREADING
X SPECIALS

Radial Adjusting Adapters

Cylindrical Shank Adapters

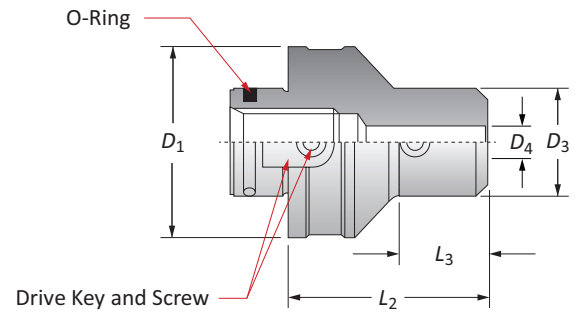

Adapter					Spare Parts				
D_1	D_4	D_3	L_2	L_3	Part No.	Drive Key	Screw	Set Screw	Set Screw Key
50	6	25	50	22.5	35.50R.06.50	TAB3924	M4x8V	M6x8G	3mm
50	8	28	50	24.5	35.50R.08.50	TAB3924	M4x8V	M6x8G	4mm
50	10	35	50	26.5	35.50R.10.50	TAB3924	M4x8V	M10x10G	5mm
50	12	42	60	38.5	35.50R.12.60	TAB3924	M4x8V	M12x12G	6mm
50	14	44	60	42	35.50R.14.60	TAB3924	M4x8V	M12x12G	6mm
50	16	48	60	40	35.50R.16.60	TAB3924	M4x8V	M14x14G	6mm
50	18	50	60	-	35.50R.18.60	TAB3924	M4x8V	M14x14G	6mm
50	20	52	60	41	35.50R.20.60	TAB3924	M4x8V	M16x2x14G	8mm
63	8	28	60	28	35.63R.08.60	TAB3923.1	M6x12V	M8x8G	4mm
63	10	35	70	40	35.63R.10.70	TAB3923.1	M6x12V	M10x10G	5mm
63	12	42	70	42	35.63R.12.70	TAB3923.1	M6x12V	M12x12G	6mm
63	14	44	60	32	35.63R.14.60	TAB3923.1	M6x12V	M12x12G	6mm
63	16	48	70	44	35.63R.16.70	TAB3923.1	M6x12V	M14x14G	6mm
63	18	50	70	40	35.63R.18.70	TAB3923.1	M6x12V	M14x14G	6mm
63	20	52	70	45	35.63R.20.70	TAB3923.1	M6x12V	M16x2x14G	8mm
50	25	65	80	61	40.50R.25.80	TAB3924	M4x8V	M18x2x18G	8mm
50	32	72	80	65	40.50R.32.80	TAB3924	M4x8V	M20x2x18G	10mm
63	25	65	80	58	40.63R.25.80	TAB3923.1	M6x12V	M18x2x18G	8mm
63	32	72	80	-	40.63R.32.80	TAB3923.1	M6x12V	M20x2x18G	10mm
80	25	65	80	50.5	40.80R.25.80	TAB3923.2	M6x12V	M18x2x18G	8mm
80	32	72	80	54	40.80R.32.80	TAB3923.2	M6x12V	M20x2x18G	10mm

Reference Key

Symbol	Attribute
D_1	Modular shank size
D_3	Body diameter
D_4	Shank diameter
L_2	Gage length
L_3	Reference length

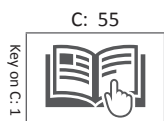

Modular System courtesy of 

Cutting Ring Style Reamers

Product Overview

Cutting Ring Reamer Features

- Diameter range: 0.6929" - 7.8972" (17.60mm - 200.59mm)
- Available with straight or left hand helical flutes
- Expandable up to 4% of nominal diameter
- Mandrels are available for both through holes or blind holes
- Work day lead time 20 - 25 days
- Available for recondition

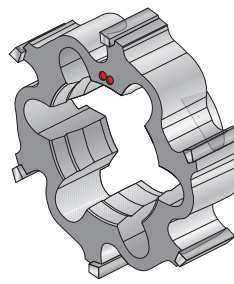

Straight Flute

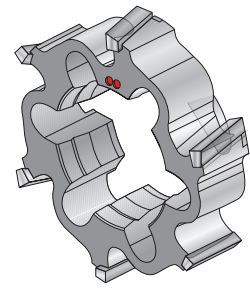

Left Hand Helical Flute



Uncoated

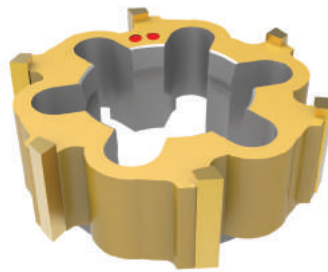

TiN Coated

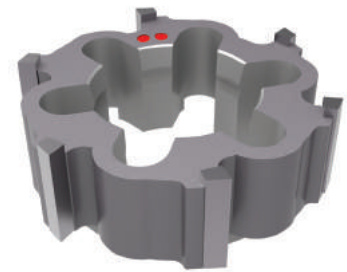

TiAlN Coated

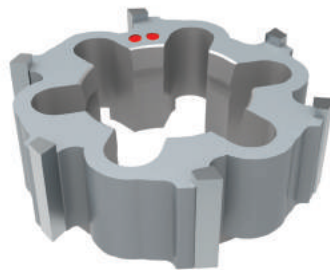

TiCN Coated



Alcrona Coated

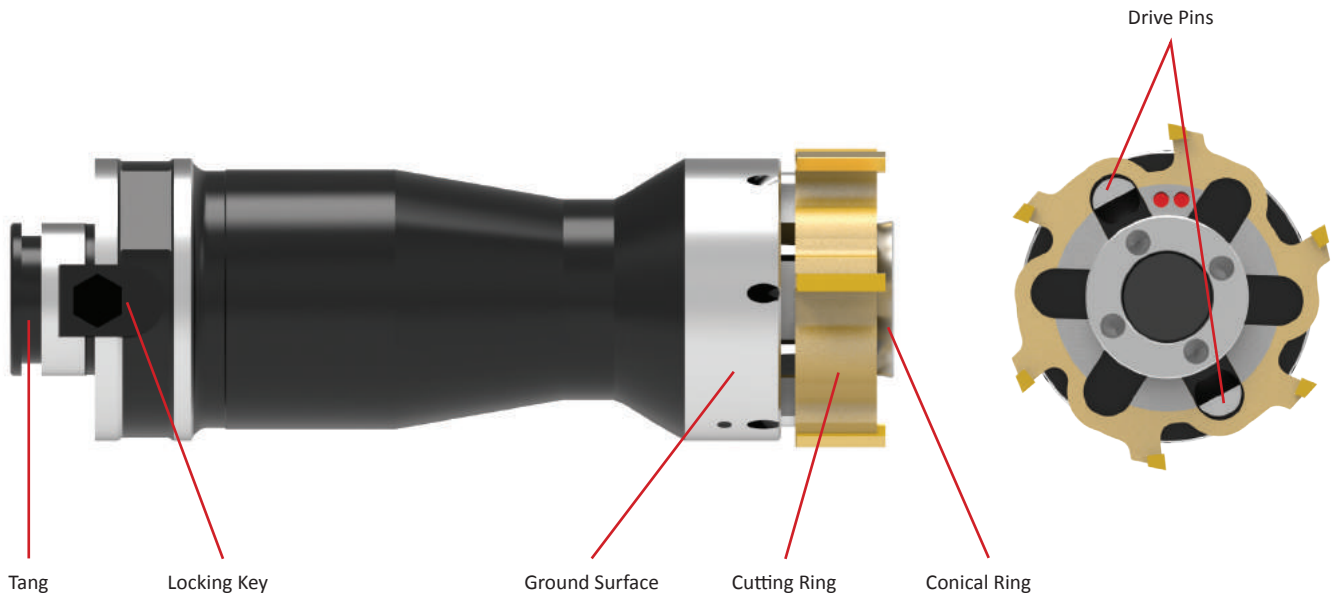

Product Nomenclature

Cutting Rings

I	-	2ANC-KT	-	F	-	019686	+	0000	-	0005
1		2		3		4		5		

NOTE: If diameter and tolerance are specified in inch units, put an "I" at the beginning of the item number

<p>1. Cutting Ring</p> <p>Blank = Metric diameter I = Inch diameter</p>	<p>2. Coating and Substrate</p> <table border="0"> <tr> <td>2000-KT = Uncoated carbide</td> <td>2AVC-ST = Uncoated cermet</td> </tr> <tr> <td>2TIN-KT = TiN coated carbide</td> <td>2ANC-ST = TiN coated cermet</td> </tr> <tr> <td>2TIC-KT = TiCN coated carbide</td> <td>2ACC-ST = TiCN coated cermet</td> </tr> <tr> <td>2TIA-KT = TiAlN coated carbide</td> <td>2AAC-ST = TiAlN coated cermet</td> </tr> <tr> <td>2TLK-KT = Alcrona coated carbide</td> <td>2ALK-ST = Alcrona coated cermet</td> </tr> </table>		2000-KT = Uncoated carbide	2AVC-ST = Uncoated cermet	2TIN-KT = TiN coated carbide	2ANC-ST = TiN coated cermet	2TIC-KT = TiCN coated carbide	2ACC-ST = TiCN coated cermet	2TIA-KT = TiAlN coated carbide	2AAC-ST = TiAlN coated cermet	2TLK-KT = Alcrona coated carbide	2ALK-ST = Alcrona coated cermet
2000-KT = Uncoated carbide	2AVC-ST = Uncoated cermet											
2TIN-KT = TiN coated carbide	2ANC-ST = TiN coated cermet											
2TIC-KT = TiCN coated carbide	2ACC-ST = TiCN coated cermet											
2TIA-KT = TiAlN coated carbide	2AAC-ST = TiAlN coated cermet											
2TLK-KT = Alcrona coated carbide	2ALK-ST = Alcrona coated cermet											
<p>3. Lead-in</p> <p>E, M = Left hand helical flute A, F, G, L, N, T, V = Straight flute J, W, X, Y = Straight Flute with chipbreaker</p>	<p>4. Diameter</p> <p>XX.XXXX = Inch XXX.XXX = Metric</p>	<p>5. Tolerance</p> <p>4 decimal places = inch tolerance 3 decimal places = mm tolerance</p> <p>*The total tolerance capable is 0.0002" (0.005mm)</p>										

Reference Key

Symbol	Attribute
D_1	Reamer diameter
D_2	Shank diameter
D_3	Maximum conical ring diameter
L_1	Overall length
L_2	Length of cut
L_5	Maximum overhang
L_7	Shank length
L_{15}	Flute length

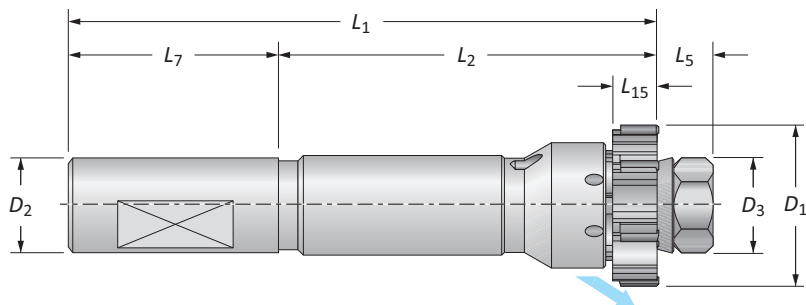

Building Your Complete Tool

You will need both pieces to complete your ring style reamer assembly. There is a guide on the page where the rings are located. You must follow the guide to build the item number for the reamer ring that you need.

However, the complete mandrel item numbers are listed on their respective pages. You do not need to build the mandrel numbers.

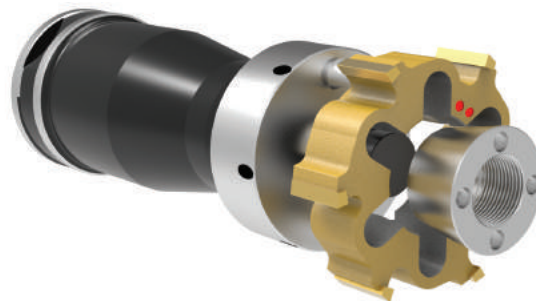



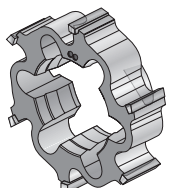

1



Select Your Ring



2



Select Your Mandrel

Cutting Rings

Imperial (inch) | Diameter Range: 0.6929" - 7.8976"

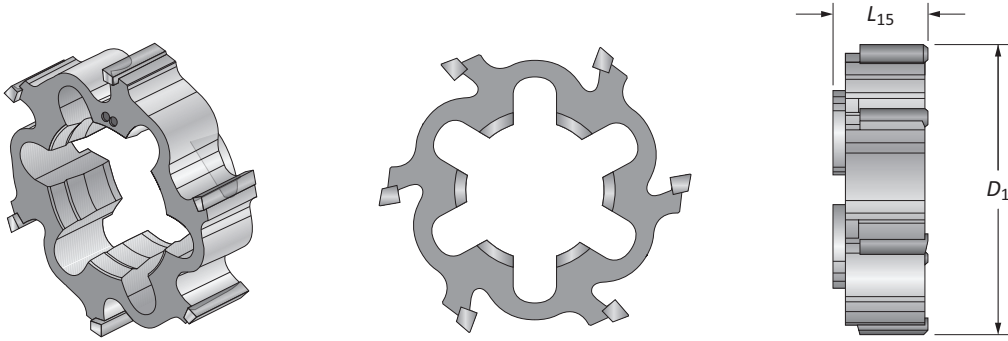

D_1 Range	L_{15}		Number of Teeth
	Imperial (inch)		
0.6929 - 0.8503	0.433	–	6
0.8504 - 1.0078	0.472	–	6
1.0079 - 1.2834	0.551	–	6
1.2835 - 1.7952	0.630	0.630	6
1.7953 - 3.1338	0.728	0.728	6
3.1339 - 3.9605	0.728	0.728	8
3.9606 - 4.3542	0.728	0.728	10
4.3543 - 7.8976	0.728	0.728	12

I 2ANC-STF-019686

Imperial Item

Cermet w/
TiN Coating

F Lead-in

Diameter (D_1)

Coating and Substrate Codes

Grade	Uncoated	TiN	TiCN	TiAlN	Alcrona
Carbide	2000-KT	2TIN-KT	2TIC-KT	2TIA-KT	2TLK-KK
Cermet	2AVC-ST	2ANC-ST	2ACC-ST	2AAC-ST	2ALK-SK

Lead-in Recommendations

ISO Material	T	F	N	G	L	A	V
P			●	●		○	○
S	●			○			
M				●	○		
H			○	●			
K	○			●			○
N				●		●	○

● Best ○ Better ○ Good

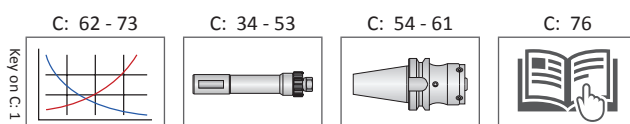



Cutting Rings

Metric (mm) | Diameter Range: 17.600mm - 200.600mm

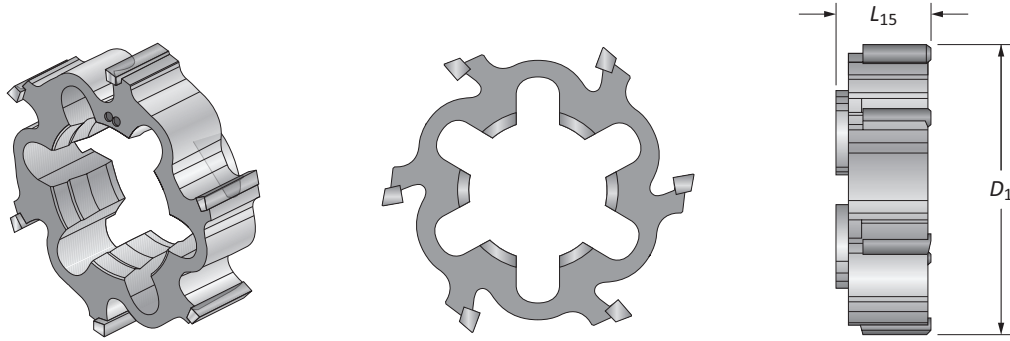

D_1 Range	L_{15}		Number of Teeth
	Straight Flute	Helical Flute	
Metric (mm)			
17.600 - 21.599	11.00	-	6
21.600 - 25.599	12.00	-	6
25.600 - 32.599	14.00	-	6
32.600 - 45.599	16.00	16.00	6
45.600 - 79.599	18.50	18.50	6
79.600 - 100.599	18.50	18.50	8
100.600 - 110.599	18.50	18.50	10
110.600 - 200.600	18.50	18.50	12

2ANC-STF-019686

Cermet w/
TiN Coating

F Lead-in

Diameter (D_1)

Coating and Substrate Codes

Grade	Uncoated	TiN	TiCN	TiAlN	Alcrona
Carbide	2000-KT	2TIN-KT	2TIC-KT	2TIA-KT	2TLK-KK
Cermet	2AVC-ST	2ANC-ST	2ACC-ST	2AAC-ST	2ALK-SK

Lead-in Recommendations

ISO Material	T	F	N	G	L	A	V
P			●	●		◐	○
S	●			◐			
M				●	◐		
H			◐	●			
K	○			●			◐
N				●		●	◐

● Best ◐ Better ○ Good

Key on C-1

C: 62 - 73

C: 34 - 53

C: 54 - 61

C: 76

Ring Style Mandrels

4550 Series | Short Length | Diameter Range: 0.6929" - 3.9602" (17.60mm - 100.59mm)

Series	4550
Shank Type	Cylindrical
Application	Through Holes
Coolant	Radial

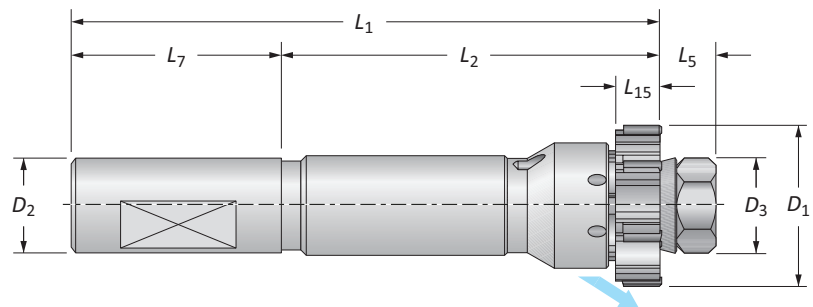

	Mandrel						Shank		Teeth	Part No. (Complete Mandrel*)	
	D ₁ Range	D ₃	L ₅	L ₁₅	L ₂	L ₁	L ₇	D ₂		With Flat	Without Flat
i	0.6929 - 0.8503	0.472	0.433	0.433	3.189	5.591	1.969	0.750	6	94550-MC-010	94550A-MC-010
	0.8504 - 1.0078	0.472	0.433	0.472	3.189	5.591	1.969	0.750	6	94550-MC-020	94550A-MC-020
	1.0079 - 1.2834	0.614	0.433	0.551	4.016	6.417	1.969	0.750	6	94550-MC-030	94550A-MC-030
	1.2835 - 1.5983	0.866	0.551	0.630	4.016	6.772	2.205	1.000	6	94550-MC-040	94550A-MC-040
	1.5984 - 1.7952	1.000	0.591	0.630	4.016	6.811	2.205	1.000	6	94550-MC-050	94550A-MC-050
	1.7953 - 1.9527	1.181	0.807	0.728	4.134	7.303	2.362	1.250	6	94550-MC-060	94550A-MC-060
	1.9528 - 2.3857	1.181	0.807	0.728	4.134	7.303	2.362	1.250	6	94550-MC-070	94550A-MC-070
	2.3858 - 2.7794	1.575	0.965	0.728	4.134	7.461	2.362	1.250	6	94550-MC-080	94550A-MC-080
	2.7795 - 3.1338	1.575	0.965	0.728	4.134	7.461	2.362	1.250	6	94550-MC-090	94550A-MC-090
	3.1339 - 3.5668	2.205	1.122	0.728	4.134	8.012	2.756	1.500	8	94550-MC-100	94550A-MC-100
3.5669 - 3.9602	2.205	1.122	0.728	4.134	8.012	2.756	1.500	8	94550-MC-110	94550A-MC-110	
m	17.60 - 21.59	12	11	11	81	142	50	20	6	4550-MC-010	4550A-MC-010
	21.60 - 25.59	12	11	12	81	142	50	20	6	4550-MC-020	4550A-MC-020
	25.60 - 32.59	15.6	11	14	102	163	50	20	6	4550-MC-030	4550A-MC-030
	32.60 - 40.59	22	14	16	102	172	56	25	6	4550-MC-040	4550A-MC-040
	40.60 - 45.59	25.4	15	16	102	173	56	25	6	4550-MC-050	4550A-MC-050
	45.60 - 49.59	30	20.5	18.5	105	185.5	60	32	6	4550-MC-060	4550A-MC-060
	49.60 - 60.59	30	20.5	18.5	105	185.5	60	32	6	4550-MC-070	4550A-MC-070
	60.60 - 70.59	40	24.5	18.5	105	189.5	60	32	6	4550-MC-080	4550A-MC-080
	70.60 - 79.59	40	24.5	18.5	105	189.5	60	32	6	4550-MC-090	4550A-MC-090
	79.60 - 90.59	56	28.5	18.5	105	203.5	70	40	8	4550-MC-100	4550A-MC-100
90.60 - 100.59	56	28.5	18.5	105	203.5	70	40	8	4550-MC-110	4550A-MC-110	

*Complete mandrel does not include cutting ring.

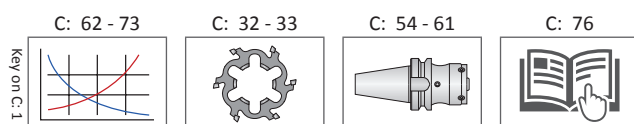

i = Imperial (in)
m = Metric (mm)



Ring Style Mandrels

4550 Series | Short Length | Spare Parts

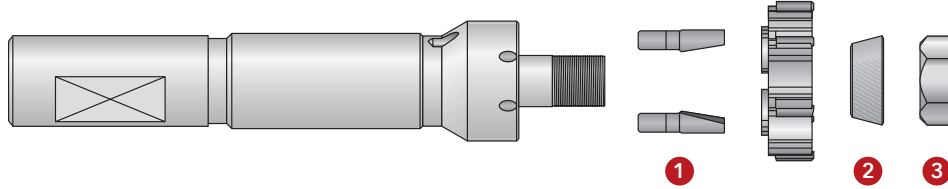

	Part No. (Complete Mandrel*)		Spare Parts				
	With Flat	Without Flat	1 Drive Pins	2 Number of Drive Pins	3 Conical Ring	4 Nut	5 Wrench Size (mm)
i	94550-MC-010	94550A-MC-010	2000-CO-010	3	2010-AC-010	2000-DA-010	10
	94550-MC-020	94550A-MC-020	2000-CO-020	3	2010-AC-010	2000-DA-010	10
	94550-MC-030	94550A-MC-030	2000-CO-030	3	2010-AC-020	2000-DA-020	13
	94550-MC-040	94550A-MC-040	2000-CO-040	2	2010-AC-030	2000-DA-060	19
	94550-MC-050	94550A-MC-050	2000-CO-060	2	2010-AC-040	2000-DA-090	22
	94550-MC-060	94550A-MC-060	2000-CO-060	2	2010-AC-050	2000-GH-880	30 ♦
	94550-MC-070	94550A-MC-070	2000-CO-070	2	2010-AC-050	2000-GH-880	30 ♦
	94550-MC-080	94550A-MC-080	2000-CO-080	2	2010-AC-060	2000-GH-900	40 ♦
	94550-MC-090	94550A-MC-090	2000-CO-090	2	2010-AC-060	2000-GH-900	40 ♦
	94550-MC-100	94550A-MC-100	2000-CO-090	2	2010-AC-070	2000-GH-920	56 ♦
	94550-MC-110	94550A-MC-110	2000-CO-090	2	2010-AC-070	2000-GH-920	56 ♦
ii	4550-MC-010	4550A-MC-010	2000-CO-010	3	2010-AC-010	2000-DA-010	10
	4550-MC-020	4550A-MC-020	2000-CO-020	3	2010-AC-010	2000-DA-010	10
	4550-MC-030	4550A-MC-030	2000-CO-030	3	2010-AC-020	2000-DA-020	13
	4550-MC-040	4550A-MC-040	2000-CO-040	2	2010-AC-030	2000-DA-060	19
	4550-MC-050	4550A-MC-050	2000-CO-060	2	2010-AC-040	2000-DA-090	22
	4550-MC-060	4550A-MC-060	2000-CO-060	2	2010-AC-050	2000-GH-880	30 ♦
	4550-MC-070	4550A-MC-070	2000-CO-070	2	2010-AC-050	2000-GH-880	30 ♦
	4550-MC-080	4550A-MC-080	2000-CO-080	2	2010-AC-060	2000-GH-900	40 ♦
	4550-MC-090	4550A-MC-090	2000-CO-090	2	2010-AC-060	2000-GH-900	40 ♦
	4550-MC-100	4550A-MC-100	2000-CO-090	2	2010-AC-070	2000-GH-920	56 ♦
	4550-MC-110	4550A-MC-110	2000-CO-090	2	2010-AC-070	2000-GH-920	56 ♦

*Complete mandrel does not include cutting ring.

♦ Spanner wrench

i = Imperial (in)
ii = Metric (mm)

Ring Style Mandrels

4555 Series | Short Length | Diameter Range: 0.6929" - 3.9602" (17.60mm - 100.59mm)

Series	4555
Shank Type	Cylindrical
Application	Blind Holes
Coolant	Radial

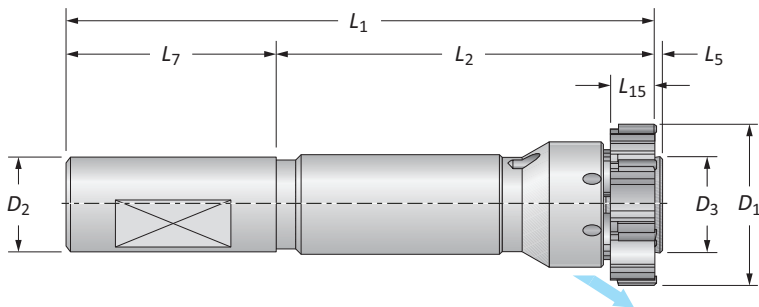

	Mandrel						Shank		Teeth	Part No. (Complete Mandrel*)	
	D ₁ Range	D ₃	L ₅	L ₁₅	L ₂	L ₁	L ₇	D ₂		With Flat	Without Flat
	0.6929 - 0.8503	0.441	0.039	0.433	3.189	5.197	1.969	0.750	6	94555-MC-010	94555A-MC-010
	0.8504 - 1.0078	0.441	0.039	0.472	3.189	5.197	1.969	0.750	6	94555-MC-020	94555A-MC-020
	1.0079 - 1.1653	0.594	0.039	0.551	4.016	6.024	1.969	0.750	6	94555-MC-030	94555A-MC-030
	1.1654 - 1.2834	0.594	0.039	0.551	4.016	6.024	1.969	0.750	6	94555-MC-035	94555A-MC-035
	1.2835 - 1.4408	0.799	0.039	0.630	4.016	6.260	2.205	1.000	6	94555-MC-040	94555A-MC-040
	1.4409 - 1.5983	0.799	0.039	0.630	4.016	6.260	2.205	1.000	6	94555-MC-045	94555A-MC-045
	1.5984 - 1.7952	0.949	0.039	0.630	4.016	6.260	2.205	1.000	6	94555-MC-050	94555A-MC-050
i	1.7953 - 1.9527	1.098	0.059	0.728	4.134	6.555	2.362	1.250	6	94555-MC-060	94555A-MC-060
	1.9528 - 2.1889	1.098	0.059	0.728	4.134	6.555	2.362	1.250	6	94555-MC-070	94555A-MC-070
	2.1890 - 2.3857	1.098	0.059	0.728	4.134	6.555	2.362	1.250	6	94555-MC-075	94555A-MC-075
	2.3858 - 2.5826	1.461	0.059	0.728	4.134	6.555	2.362	1.250	6	94555-MC-080	94555A-MC-080
	2.5827 - 2.7794	1.461	0.059	0.728	4.134	6.555	2.362	1.250	6	94555-MC-085	94555A-MC-085
	2.7795 - 3.1338	1.461	0.059	0.728	4.134	6.555	2.362	1.250	6	94555-MC-090	94555A-MC-090
	3.1339 - 3.5668	2.091	0.059	0.728	4.134	6.949	2.756	1.500	8	94555-MC-100	94555A-MC-100
	3.5669 - 3.9602	2.091	0.059	0.728	4.134	6.949	2.756	1.500	8	94555-MC-110	94555A-MC-110
m	17.60 - 21.59	11.2	1	11	81	132	50	20	6	4555-MC-010	4555A-MC-010
	21.60 - 25.59	11.2	1	12	81	132	50	20	6	4555-MC-020	4555A-MC-020
	25.60 - 29.59	15.1	1	14	102	153	50	20	6	4555-MC-030	4555A-MC-030
	29.60 - 32.59	15.1	1	14	102	153	50	20	6	4555-MC-035	4555A-MC-035
	32.60 - 36.59	20.3	1	16	102	159	56	25	6	4555-MC-040	4555A-MC-040
	36.60 - 40.59	20.3	1	16	102	159	56	25	6	4555-MC-045	4555A-MC-045
	40.60 - 45.59	24.1	1	16	102	159	56	25	6	4555-MC-050	4555A-MC-050
	45.60 - 49.59	27.9	1.5	18.5	105	166.5	60	32	6	4555-MC-060	4555A-MC-060
	49.60 - 55.59	27.9	1.5	18.5	105	166.5	60	32	6	4555-MC-070	4555A-MC-070
	55.60 - 60.59	27.9	1.5	18.5	105	166.5	60	32	6	4555-MC-075	4555A-MC-075
	60.60 - 65.59	37.1	1.5	18.5	105	166.5	60	32	6	4555-MC-080	4555A-MC-080
	65.60 - 70.59	37.1	1.5	18.5	105	166.5	60	32	6	4555-MC-085	4555A-MC-085
	70.60 - 79.59	37.1	1.5	18.5	105	166.5	60	32	6	4555-MC-090	4555A-MC-090
	79.60 - 90.59	53.1	1.5	18.5	105	176.5	70	40	8	4555-MC-100	4555A-MC-100
	90.60 - 100.59	53.1	1.5	18.5	105	176.5	70	40	8	4555-MC-110	4555A-MC-110

*Complete mandrel does not include cutting ring.

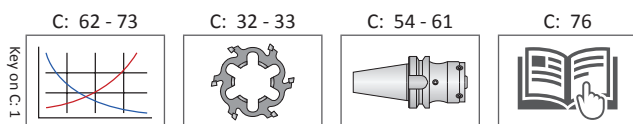

i = Imperial (in)
m = Metric (mm)

Ring Style Mandrels

4555 Series | Short Length | Spare Parts

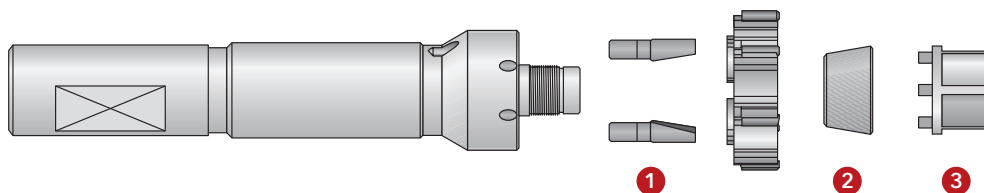

Part No. (Complete Mandrel*)		Spare Parts							Wrench Size (mm)
With Flat	Without Flat	1 Drive Pins	Number of Drive Pins	2 Conical Ring	Conical Ring (2nd Expansion)	Conical Ring (3rd Expansion)	3 Adjusting Key		
94555-MC-010	94555A-MC-010	2000-CO-010	3	4001-AC-115	4001-AC-215	-	4001-CH-015	10	
94555-MC-020	94555A-MC-020	2000-CO-020	3	4001-AC-115	4001-AC-215	-	4001-CH-015	10	
94555-MC-030	94555A-MC-030	2000-CO-030	3	4001-AC-125	4001-AC-225	4001-AC-325	4001-CH-025	13	
94555-MC-035	94555A-MC-035	2000-CO-040	2	4001-AC-125	4001-AC-225	4001-AC-325	4001-CH-025	13	
94555-MC-040	94555A-MC-040	2000-CO-040	2	4001-AC-135	4001-AC-235	4001-AC-335	4001-CH-035	18	
94555-MC-045	94555A-MC-045	2000-CO-050	2	4001-AC-135	4001-AC-235	4001-AC-335	4001-CH-035	18	
94555-MC-050	94555A-MC-050	2000-CO-060	2	4001-AC-145	4001-AC-245	4001-AC-345	4001-CH-045	22	
94555-MC-060	94555A-MC-060	2000-CO-060	2	4001-AC-155	4001-AC-255	4001-AC-355	4001-CH-055	26	
94555-MC-070	94555A-MC-070	2000-CO-070	2	4001-AC-155	4001-AC-255	4001-AC-355	4001-CH-055	26	
94555-MC-075	94555A-MC-075	2000-CO-080	2	4001-AC-155	4001-AC-255	4001-AC-355	4001-CH-055	26	
94555-MC-080	94555A-MC-080	2000-CO-080	2	4001-AC-165	4001-AC-265	4001-AC-365	4001-CH-065	34	
94555-MC-085	94555A-MC-085	2000-CO-090	2	4001-AC-165	4001-AC-265	4001-AC-365	4001-CH-065	34	
94555-MC-090	94555A-MC-090	2000-CO-090	2	4001-AC-165	4001-AC-265	4001-AC-365	4001-CH-065	34	
94555-MC-100	94555A-MC-100	2000-CO-090	2	4001-AC-185	4001-AC-285	4001-AC-385	4001-CH-085	46	
94555-MC-110	94555A-MC-110	2000-CO-090	2	4001-AC-185	4001-AC-285	4001-AC-385	4001-CH-085	46	
4555-MC-010	4555A-MC-010	2000-CO-010	3	4001-AC-115	4001-AC-215	-	4001-CH-015	10	
4555-MC-020	4555A-MC-020	2000-CO-020	3	4001-AC-115	4001-AC-215	-	4001-CH-015	10	
4555-MC-030	4555A-MC-030	2000-CO-030	3	4001-AC-125	4001-AC-225	4001-AC-325	4001-CH-025	13	
4555-MC-035	4555A-MC-035	2000-CO-040	2	4001-AC-125	4001-AC-225	4001-AC-325	4001-CH-025	13	
4555-MC-040	4555A-MC-040	2000-CO-040	2	4001-AC-135	4001-AC-235	4001-AC-335	4001-CH-035	18	
4555-MC-045	4555A-MC-045	2000-CO-050	2	4001-AC-135	4001-AC-235	4001-AC-335	4001-CH-035	18	
4555-MC-050	4555A-MC-050	2000-CO-060	2	4001-AC-145	4001-AC-245	4001-AC-345	4001-CH-045	22	
4555-MC-060	4555A-MC-060	2000-CO-060	2	4001-AC-155	4001-AC-255	4001-AC-355	4001-CH-055	26	
4555-MC-070	4555A-MC-070	2000-CO-070	2	4001-AC-155	4001-AC-255	4001-AC-355	4001-CH-055	26	
4555-MC-075	4555A-MC-075	2000-CO-080	2	4001-AC-155	4001-AC-255	4001-AC-355	4001-CH-055	26	
4555-MC-080	4555A-MC-080	2000-CO-080	2	4001-AC-165	4001-AC-265	4001-AC-365	4001-CH-065	34	
4555-MC-085	4555A-MC-085	2000-CO-090	2	4001-AC-165	4001-AC-265	4001-AC-365	4001-CH-065	34	
4555-MC-090	4555A-MC-090	2000-CO-090	2	4001-AC-165	4001-AC-265	4001-AC-365	4001-CH-065	34	
4555-MC-100	4555A-MC-100	2000-CO-090	2	4001-AC-185	4001-AC-285	4001-AC-385	4001-CH-085	46	
4555-MC-110	4555A-MC-110	2000-CO-090	2	4001-AC-185	4001-AC-285	4001-AC-385	4001-CH-085	46	

*Complete mandrel does not include cutting ring.

ⓘ = Imperial (in)
Ⓜ = Metric (mm)

Ring Style Mandrels

4500 Series | Long Length | Diameter Range: 0.6929" - 3.9602" (17.60mm - 100.59mm)

Series	4500
Shank Type	Cylindrical
Application	Through Holes
Coolant	Radial

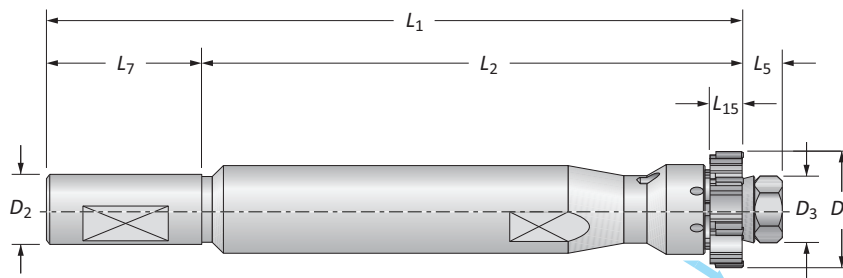

	Mandrel						Shank		Teeth	Part No. (Complete Mandrel*)	
	D ₁ Range	D ₃	L ₅	L ₁₅	L ₂	L ₁	L ₇	D ₂		With Flat	Without Flat
i	0.6929 - 0.8503	0.472	0.433	0.433	4.764	7.165	1.969	0.750	6	94500-MC-010	94500A-MC-010
	0.8504 - 1.0078	0.472	0.433	0.472	4.764	7.165	1.969	0.750	6	94500-MC-020	94500A-MC-020
	1.0079 - 1.2834	0.614	0.433	0.551	6.024	8.425	1.969	0.750	6	94500-MC-030	94500A-MC-030
	1.2835 - 1.5983	0.866	0.551	0.630	7.047	9.803	2.205	1.000	6	94500-MC-040	94500A-MC-040
	1.5984 - 1.7952	0.866	0.551	0.630	7.047	9.803	2.205	1.000	6	94500-MC-050	94500A-MC-050
	1.7953 - 1.9527	1.000	0.591	0.630	7.913	10.709	2.205	1.000	6	94500-MC-060	94500A-MC-060
	1.9528 - 2.3857	1.181	0.807	0.728	8.425	11.594	2.362	1.250	6	94500-MC-070	94500A-MC-070
	2.3858 - 2.7794	1.575	0.965	0.728	9.331	12.657	2.362	1.250	6	94500-MC-080	94500A-MC-080
	2.7795 - 3.1338	1.575	0.965	0.728	9.331	12.657	2.362	1.250	6	94500-MC-090	94500A-MC-090
	3.1339 - 3.5668	2.205	1.122	0.728	9.646	13.524	2.756	1.500	6	94500-MC-100	94500A-MC-100
3.5669 - 3.9602	2.205	1.122	0.728	9.646	13.524	2.756	1.500	8	94500-MC-110	94500A-MC-110	
m	17.60 - 21.59	12	11	11	121	182	50	20	6	4500-MC-010	4500A-MC-010
	21.60 - 25.59	12	11	12	121	182	50	20	6	4500-MC-020	4500A-MC-020
	25.60 - 32.59	15.6	11	14	153	214	50	20	6	4500-MC-030	4500A-MC-030
	32.60 - 40.59	22	14	16	179	249	56	25	6	4500-MC-040	4500A-MC-040
	40.60 - 45.59	25.4	15	16	201	272	56	25	6	4500-MC-050	4500A-MC-050
	45.60 - 49.59	30	20.5	18.5	214	294.5	60	32	6	4500-MC-060	4500A-MC-060
	49.60 - 60.59	30	20.5	18.5	214	294.5	60	32	6	4500-MC-070	4500A-MC-070
	60.60 - 70.59	40	24.5	18.5	237	321.5	60	32	6	4500-MC-080	4500A-MC-080
	70.60 - 79.59	40	24.5	18.5	237	321.5	60	32	6	4500-MC-090	4500A-MC-090
	79.60 - 90.59	56	28.5	18.5	245	343.5	70	40	6	4500-MC-100	4500A-MC-100
90.60 - 100.59	56	28.5	18.5	245	343.5	70	40	8	4500-MC-110	4500A-MC-110	

*Complete mandrel does not include cutting ring.

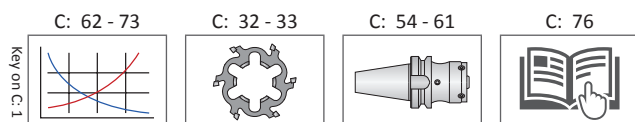
 i = Imperial (in)
 m = Metric (mm)



Ring Style Mandrels

4500 Series | Long Length | Spare Parts

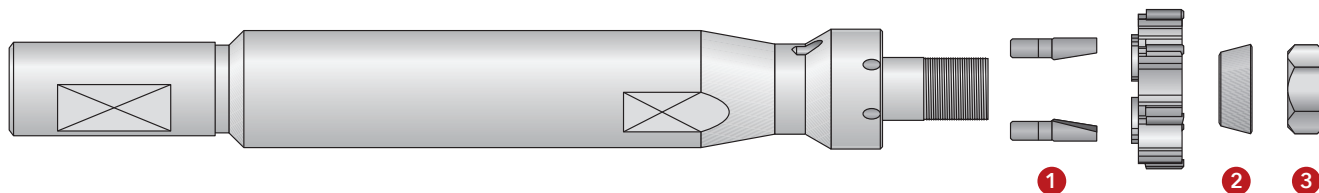

	Part No. (Complete Mandrel*)		Spare Parts				
	With Flat	Without Flat	1 Drive Pins	2 Number of Drive Pins	3 Conical Ring	Nut	Wrench Size (mm)
i	94500-MC-010	94500A-MC-010	2000-CO-010	3	2010-AC-010	2000-DA-010	10
	94500-MC-020	94500A-MC-020	2000-CO-020	3	2010-AC-010	2000-DA-010	10
	94500-MC-030	94500A-MC-030	2000-CO-030	3	2010-AC-020	2000-DA-020	13
	94500-MC-040	94500A-MC-040	2000-CO-040	2	2010-AC-030	2000-DA-060	19
	94500-MC-050	94500A-MC-050	2000-CO-060	2	2010-AC-040	2000-DA-090	22
	94500-MC-060	94500A-MC-060	2000-CO-060	2	2010-AC-050	2000-GH-880	30 ♦
	94500-MC-070	94500A-MC-070	2000-CO-070	2	2010-AC-050	2000-GH-880	30 ♦
	94500-MC-080	94500A-MC-080	2000-CO-080	2	2010-AC-060	2000-GH-900	40 ♦
	94500-MC-090	94500A-MC-090	2000-CO-090	2	2010-AC-060	2000-GH-900	40 ♦
	94500-MC-100	94500A-MC-100	2000-CO-090	2	2010-AC-070	2000-GH-920	56 ♦
	94500-MC-110	94500A-MC-110	2000-CO-090	2	2010-AC-070	2000-GH-920	56 ♦
ii	4500-MC-010	4500A-MC-010	2000-CO-010	3	2010-AC-010	2000-DA-010	10
	4500-MC-020	4500A-MC-020	2000-CO-020	3	2010-AC-010	2000-DA-010	10
	4500-MC-030	4500A-MC-030	2000-CO-030	3	2010-AC-020	2000-DA-020	13
	4500-MC-040	4500A-MC-040	2000-CO-040	2	2010-AC-030	2000-DA-060	19
	4500-MC-050	4500A-MC-050	2000-CO-060	2	2010-AC-040	2000-DA-090	22
	4500-MC-060	4500A-MC-060	2000-CO-060	2	2010-AC-050	2000-GH-880	30 ♦
	4500-MC-070	4500A-MC-070	2000-CO-070	2	2010-AC-050	2000-GH-880	30 ♦
	4500-MC-080	4500A-MC-080	2000-CO-080	2	2010-AC-060	2000-GH-900	40 ♦
	4500-MC-090	4500A-MC-090	2000-CO-090	2	2010-AC-060	2000-GH-900	40 ♦
	4500-MC-100	4500A-MC-100	2000-CO-090	2	2010-AC-070	2000-GH-920	56 ♦
	4500-MC-110	4500A-MC-110	2000-CO-090	2	2010-AC-070	2000-GH-920	56 ♦

*Complete mandrel does not include cutting ring.

♦ Spanner wrench

i = Imperial (in)
ii = Metric (mm)

R
A
DRILLING
B
BORING
C
REAMING
D
URNISHING
E
HREADING
X
PECIALS

REAMING | ALVAN® Reaming Systems by S.C.A.M.I.®

Ring Style Mandrels

4505 Series | Long Length | Diameter Range: 0.6929" - 3.9602" (17.60mm - 100.59mm)

Series	4505
Shank Type	Cylindrical
Application	Blind Holes
Coolant	Radial

D ₁ Range	Mandrel					Shank			Teeth	Part No. (Complete Mandrel*)	
	D ₃	L ₅	L ₁₅	L ₂	L ₁	L ₇	D ₂	With Flat		Without Flat	
0.6929 - 0.8503	0.441	0.039	0.433	4.764	6.772	1.969	0.750	6	94505-MC-010	94505A-MC-010	
0.8504 - 1.0078	0.441	0.039	0.472	4.764	6.772	1.969	0.750	6	94505-MC-020	94505A-MC-020	
1.0079 - 1.1653	0.594	0.039	0.551	6.024	8.031	1.969	0.750	6	94505-MC-030	94505A-MC-030	
1.1654 - 1.2834	0.594	0.039	0.551	6.024	8.031	1.969	0.750	6	94505-MC-035	94505A-MC-035	
1.2835 - 1.4408	0.799	0.039	0.630	7.047	9.291	2.205	1.000	6	94505-MC-040	94505A-MC-040	
1.4409 - 1.5983	0.799	0.039	0.630	7.047	9.291	2.205	1.000	6	94505-MC-045	94505A-MC-045	
1.5984 - 1.7952	0.949	0.039	0.630	7.913	10.157	2.205	1.000	6	94505-MC-050	94505A-MC-050	
1.7953 - 1.9527	1.098	0.059	0.728	8.425	10.846	2.362	1.250	6	94505-MC-060	94505A-MC-060	
1.9528 - 2.1889	1.098	0.059	0.728	8.425	10.846	2.362	1.250	6	94505-MC-070	94505A-MC-070	
2.1890 - 2.3857	1.098	0.059	0.728	8.425	10.846	2.362	1.250	6	94505-MC-075	94505A-MC-075	
2.3858 - 2.5826	1.461	0.059	0.728	9.331	11.752	2.362	1.250	6	94505-MC-080	94505A-MC-080	
2.5827 - 2.7794	1.461	0.059	0.728	9.331	11.752	2.362	1.250	6	94505-MC-085	94505A-MC-085	
2.7795 - 3.1338	1.461	0.059	0.728	9.331	11.752	2.362	1.250	6	94505-MC-090	94505A-MC-090	
3.1339 - 3.5668	2.091	0.059	0.728	9.646	12.461	2.756	1.500	8	94505-MC-100	94505A-MC-100	
3.5669 - 3.9602	2.091	0.059	0.728	9.646	12.461	2.756	1.500	8	94505-MC-110	94505A-MC-110	
17.60 - 21.59	11.2	1	11	121	172	50	20	6	4505-MC-010	4505A-MC-010	
21.60 - 25.59	11.2	1	12	121	172	50	20	6	4505-MC-020	4505A-MC-020	
25.60 - 29.59	15.1	1	14	153	204	50	20	6	4505-MC-030	4505A-MC-030	
29.60 - 32.59	15.1	1	14	153	204	50	20	6	4505-MC-035	4505A-MC-035	
32.60 - 36.59	20.3	1	16	179	236	56	25	6	4505-MC-040	4505A-MC-040	
36.60 - 40.59	20.3	1	16	179	236	56	25	6	4505-MC-045	4505A-MC-045	
40.60 - 45.59	24.1	1	16	201	258	56	25	6	4505-MC-050	4505A-MC-050	
45.60 - 49.59	27.9	1.5	18.5	214	275.5	60	32	6	4505-MC-060	4505A-MC-060	
49.60 - 55.59	27.9	1.5	18.5	214	275.5	60	32	6	4505-MC-070	4505A-MC-070	
55.60 - 60.59	27.9	1.5	18.5	214	275.5	60	32	6	4505-MC-075	4505A-MC-075	
60.60 - 65.59	37.1	1.5	18.5	237	298.5	60	32	6	4505-MC-080	4505A-MC-080	
65.60 - 70.59	37.1	1.5	18.5	237	298.5	60	32	6	4505-MC-085	4505A-MC-085	
70.60 - 79.59	37.1	1.5	18.5	237	298.5	60	32	6	4505-MC-090	4505A-MC-090	
79.60 - 90.59	53.1	1.5	18.5	245	316.5	70	40	8	4505-MC-100	4505A-MC-100	
90.60 - 100.59	53.1	1.5	18.5	245	316.5	70	40	8	4505-MC-110	4505A-MC-110	

*Complete mandrel does not include cutting ring.

C: 62 - 73 C: 32 - 33 C: 54 - 61 C: 76

i = Imperial (in)
m = Metric (mm)

C: 40

www.alliedmachine.com | 1.330.343.4283

Ring Style Mandrels

4505 Series | Long Length | Spare Parts

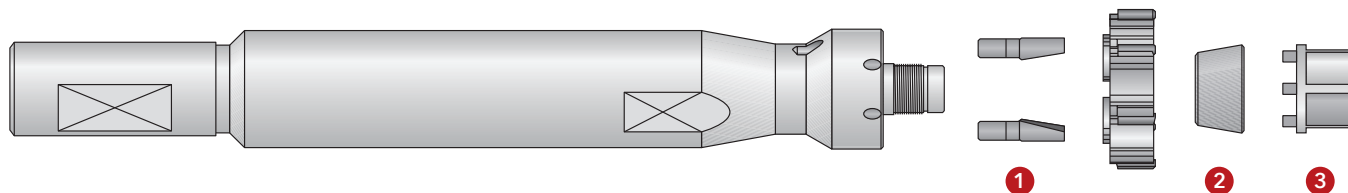

Part No. (Complete Mandrel*)		Spare Parts							Wrench Size (mm)
With Flat	Without Flat	1		2			3		
		Drive Pins	Number of Drive Pins	Conical Ring	Conical Ring (2nd Expansion)	Conical Ring (3rd Expansion)	Adjusting Key		
i 94505-MC-010	94505A-MC-010	2000-CO-010	3	4001-AC-115	4001-AC-215	–	4001-CH-015	10	
94505-MC-020	94505A-MC-020	2000-CO-020	3	4001-AC-115	4001-AC-215	–	4001-CH-015	10	
94505-MC-030	94505A-MC-030	2000-CO-030	3	4001-AC-125	4001-AC-225	4001-AC-325	4001-CH-025	13	
94505-MC-035	94505A-MC-035	2000-CO-040	2	4001-AC-125	4001-AC-225	4001-AC-325	4001-CH-025	13	
94505-MC-040	94505A-MC-040	2000-CO-040	2	4001-AC-135	4001-AC-235	4001-AC-335	4001-CH-035	18	
94505-MC-045	94505A-MC-045	2000-CO-050	2	4001-AC-135	4001-AC-235	4001-AC-335	4001-CH-035	18	
94505-MC-050	94505A-MC-050	2000-CO-060	2	4001-AC-145	4001-AC-245	4001-AC-345	4001-CH-045	22	
94505-MC-060	94505A-MC-060	2000-CO-060	2	4001-AC-155	4001-AC-255	4001-AC-355	4001-CH-055	26	
94505-MC-070	94505A-MC-070	2000-CO-070	2	4001-AC-155	4001-AC-255	4001-AC-355	4001-CH-055	26	
94505-MC-075	94505A-MC-075	2000-CO-080	2	4001-AC-155	4001-AC-255	4001-AC-355	4001-CH-055	26	
94505-MC-080	94505A-MC-080	2000-CO-080	2	4001-AC-165	4001-AC-265	4001-AC-365	4001-CH-065	34	
94505-MC-085	94505A-MC-085	2000-CO-090	2	4001-AC-165	4001-AC-265	4001-AC-365	4001-CH-065	34	
94505-MC-090	94505A-MC-090	2000-CO-090	2	4001-AC-165	4001-AC-265	4001-AC-365	4001-CH-065	34	
94505-MC-100	94505A-MC-100	2000-CO-090	2	4001-AC-185	4001-AC-285	4001-AC-385	4001-CH-085	46	
94505-MC-110	94505A-MC-110	2000-CO-090	2	4001-AC-185	4001-AC-285	4001-AC-385	4001-CH-085	46	
ii 4505-MC-010	4505A-MC-010	2000-CO-010	3	4001-AC-115	4001-AC-215	–	4001-CH-015	10	
4505-MC-020	4505A-MC-020	2000-CO-020	3	4001-AC-115	4001-AC-215	–	4001-CH-015	10	
4505-MC-030	4505A-MC-030	2000-CO-030	3	4001-AC-125	4001-AC-225	4001-AC-325	4001-CH-025	13	
4505-MC-035	4505A-MC-035	2000-CO-040	2	4001-AC-125	4001-AC-225	4001-AC-325	4001-CH-025	13	
4505-MC-040	4505A-MC-040	2000-CO-040	2	4001-AC-135	4001-AC-235	4001-AC-335	4001-CH-035	18	
4505-MC-045	4505A-MC-045	2000-CO-050	2	4001-AC-135	4001-AC-235	4001-AC-335	4001-CH-035	18	
4505-MC-050	4505A-MC-050	2000-CO-060	2	4001-AC-145	4001-AC-245	4001-AC-345	4001-CH-045	22	
4505-MC-060	4505A-MC-060	2000-CO-060	2	4001-AC-155	4001-AC-255	4001-AC-355	4001-CH-055	26	
4505-MC-070	4505A-MC-070	2000-CO-070	2	4001-AC-155	4001-AC-255	4001-AC-355	4001-CH-055	26	
4505-MC-075	4505A-MC-075	2000-CO-080	2	4001-AC-155	4001-AC-255	4001-AC-355	4001-CH-055	26	
4505-MC-080	4505A-MC-080	2000-CO-080	2	4001-AC-165	4001-AC-265	4001-AC-365	4001-CH-065	34	
4505-MC-085	4505A-MC-085	2000-CO-090	2	4001-AC-165	4001-AC-265	4001-AC-365	4001-CH-065	34	
4505-MC-090	4505A-MC-090	2000-CO-090	2	4001-AC-165	4001-AC-265	4001-AC-365	4001-CH-065	34	
4505-MC-100	4505A-MC-100	2000-CO-090	2	4001-AC-185	4001-AC-285	4001-AC-385	4001-CH-085	46	
4505-MC-110	4505A-MC-110	2000-CO-090	2	4001-AC-185	4001-AC-285	4001-AC-385	4001-CH-085	46	

*Complete mandrel does not include cutting ring.

i = Imperial (in)
ii = Metric (mm)

Ring Style Mandrels

4330 Series | Short Length | Diameter Range: 0.6929" - 3.9602 (17.60mm - 100.59mm)

Series	4330
Shank Type	Modular
Application	Through Holes
Coolant	Radial

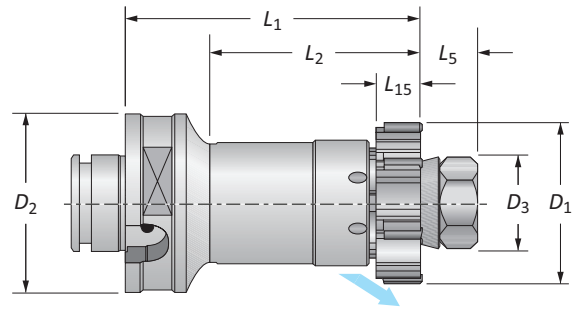

D_1 Range		Mandrel					Shank	Teeth	Part No. (Complete Mandrel*)
Imperial (inch)	Metric (mm)	D_3	L_5	L_{15}	L_2	L_1	D_2		
0.6929 - 0.8503	17.60 - 21.59	12	11	11	55	75	50	6	4330-MC-010
0.8504 - 1.0078	21.60 - 25.59	12	11	12	55	75	50	6	4330-MC-020
1.0079 - 1.2834	25.60 - 32.59	15.6	11	14	60	80	50	6	4330-MC-030
1.2835 - 1.5983	32.60 - 40.59	22	14	16	60	80	50	6	4330-MC-040
1.5984 - 1.7952	40.60 - 45.59	25.4	15	16	60	80	50	6	4330-MC-050
m 1.7953 - 1.9527	45.60 - 49.59	30	20.5	18.5	60	80	50	6	4330-MC-060
1.9528 - 2.3857	49.60 - 60.59	30	20.5	18.5	60	80	50	6	4330-MC-070
2.3858 - 2.7794	60.60 - 70.59	40	24.5	18.5	65	90	63	6	4330-MC-080
2.7795 - 3.1338	70.60 - 79.59	40	24.5	18.5	65	90	63	6	4330-MC-090
3.1339 - 3.5668	79.60 - 90.59	56	28.5	18.5	65	90	63	8	4330-MC-100
3.5669 - 3.9602	90.60 - 100.59	56	28.5	18.5	65	90	63	8	4330-MC-110

*Complete mandrel does not include cutting ring.

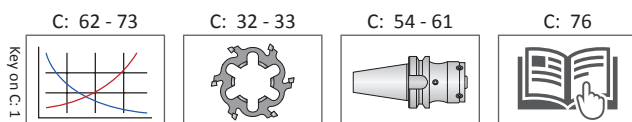

i = Imperial (in)
m = Metric (mm)



Ring Style Mandrels

4330 Series | Short Length | Spare Parts

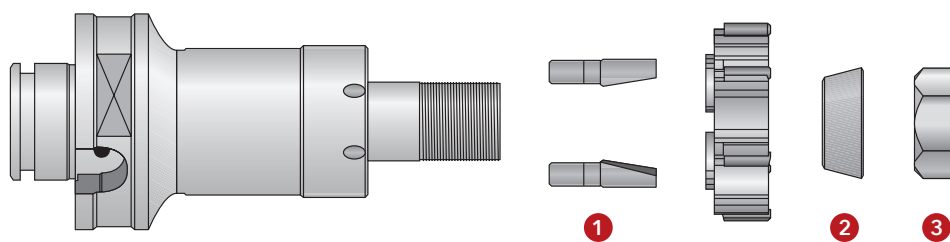

Part No. (Complete Mandrel*)	Spare Parts					Wrench Size (mm)
	1 Drive Pins	Number of Drive Pins	2 Conical Ring	3 Nut		
4330-MC-010	2000-CO-010	3	2010-AC-010	2000-DA-010	10	
4330-MC-020	2000-CO-020	3	2010-AC-010	2000-DA-010	10	
4330-MC-030	2000-CO-030	3	2010-AC-020	2000-DA-020	13	
4330-MC-040	2000-CO-040	2	2010-AC-030	2000-DA-060	19	
4330-MC-050	2000-CO-060	2	2010-AC-040	2000-DA-090	22	
4330-MC-060	2000-CO-060	2	2010-AC-050	2000-GH-880	30 ♦	
4330-MC-070	2000-CO-070	2	2010-AC-050	2000-GH-880	30 ♦	
4330-MC-080	2000-CO-080	2	2010-AC-060	2000-GH-900	40 ♦	
4330-MC-090	2000-CO-090	2	2010-AC-060	2000-GH-900	40 ♦	
4330-MC-100	2000-CO-090	2	2010-AC-070	2000-GH-920	56 ♦	
4330-MC-110	2000-CO-090	2	2010-AC-070	2000-GH-920	56 ♦	

*Complete mandrel does not include cutting ring.

♦ Spanner wrench

Ⓜ

Ⓜ = Imperial (in)
Ⓜ = Metric (mm)

Ring Style Mandrels

4335 Series | Short Length | Diameter Range: 0.6929" - 3.9602 (17.60mm - 100.59mm)

Series	4335
Shank Type	Modular
Application	Blind Holes
Coolant	Radial

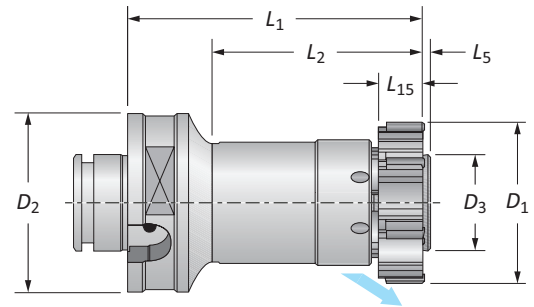

D_1 Range		Mandrel					Shank		Teeth	Part No. (Complete Mandrel*)
Imperial (inch)	Metric (mm)	D_3	L_5	L_{15}	L_2	L_1	D_2			
0.6929 - 0.8503	17.60 - 21.59	11.2	1	11	55	75	50	6	4335-MC-010	
0.8504 - 1.0078	21.60 - 25.59	11.2	1	12	55	75	50	6	4335-MC-020	
1.0079 - 1.1653	25.60 - 29.59	15.1	1	14	60	80	50	6	4335-MC-030	
1.1654 - 1.2834	29.60 - 32.59	15.1	1	14	60	80	50	6	4335-MC-035	
1.2835 - 1.4408	32.60 - 36.59	20.3	1	16	60	80	50	6	4335-MC-040	
1.4409 - 1.5983	36.60 - 40.59	20.3	1	16	60	80	50	6	4335-MC-045	
1.5984 - 1.7952	40.60 - 45.59	24.1	1	16	60	80	50	6	4335-MC-050	
m 1.7953 - 1.9527	45.60 - 49.59	27.9	1.5	18.5	60	80	50	6	4335-MC-060	
1.9528 - 2.1889	49.60 - 55.59	27.9	1.5	18.5	60	80	50	6	4335-MC-070	
2.1890 - 2.3857	55.60 - 60.59	27.9	1.5	18.5	60	80	50	6	4335-MC-075	
2.3858 - 2.5826	60.60 - 65.59	37.1	1.5	18.5	65	90	63	6	4335-MC-080	
2.5827 - 2.7794	65.60 - 70.59	37.1	1.5	18.5	65	90	63	6	4335-MC-085	
2.7795 - 3.1338	70.60 - 79.59	37.1	1.5	18.5	65	90	63	6	4335-MC-090	
3.1339 - 3.5668	79.60 - 90.59	53.1	1.5	18.5	65	90	63	8	4335-MC-100	
3.5669 - 3.9602	90.60 - 100.59	53.1	1.5	18.5	65	90	63	8	4335-MC-110	

*Complete mandrel does not include cutting ring.

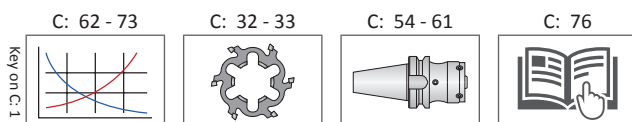



Ring Style Mandrels

4335 Series | Short Length | Spare Parts

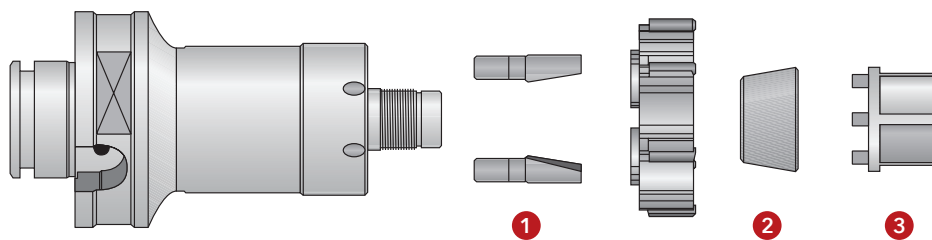

Part No. (Complete Mandrel*)	Spare Parts							Wrench Size (mm)
	1 Drive Pins	Number of Drive Pins	2 Conical Ring	Conical Ring (2nd Expansion)	Conical Ring (3rd Expansion)	3 Adjusting Key		
4335-MC-010	2000-CO-010	3	4001-AC-115	4001-AC-215	-	4001-CH-015	10	
4335-MC-020	2000-CO-020	3	4001-AC-115	4001-AC-215	-	4001-CH-015	10	
4335-MC-030	2000-CO-030	3	4001-AC-125	4001-AC-225	4001-AC-325	4001-CH-025	13	
4335-MC-035	2000-CO-040	2	4001-AC-125	4001-AC-225	4001-AC-325	4001-CH-025	13	
4335-MC-040	2000-CO-040	2	4001-AC-135	4001-AC-235	4001-AC-335	4001-CH-035	18	
4335-MC-045	2000-CO-050	2	4001-AC-135	4001-AC-235	4001-AC-335	4001-CH-035	18	
4335-MC-050	2000-CO-060	2	4001-AC-145	4001-AC-245	4001-AC-345	4001-CH-045	22	
4335-MC-060	2000-CO-060	2	4001-AC-155	4001-AC-255	4001-AC-355	4001-CH-055	26	
4335-MC-070	2000-CO-070	2	4001-AC-155	4001-AC-255	4001-AC-355	4001-CH-055	26	
4335-MC-075	2000-CO-080	2	4001-AC-155	4001-AC-255	4001-AC-355	4001-CH-055	26	
4335-MC-080	2000-CO-080	2	4001-AC-165	4001-AC-265	4001-AC-365	4001-CH-065	34	
4335-MC-085	2000-CO-090	2	4001-AC-165	4001-AC-265	4001-AC-365	4001-CH-065	34	
4335-MC-090	2000-CO-090	2	4001-AC-165	4001-AC-265	4001-AC-365	4001-CH-065	34	
4335-MC-100	2000-CO-090	2	4001-AC-185	4001-AC-285	4001-AC-385	4001-CH-085	46	
4335-MC-110	2000-CO-090	2	4001-AC-185	4001-AC-285	4001-AC-385	4001-CH-085	46	

*Complete mandrel does not include cutting ring.

① = Imperial (in)
② = Metric (mm)

Ring Style Mandrels

4350 Series | Standard Length | Diameter Range: 0.6929" - 7.8972 (17.60mm - 200.59mm)

Series	4350
Shank Type	Modular
Application	Through Holes
Coolant	Radial

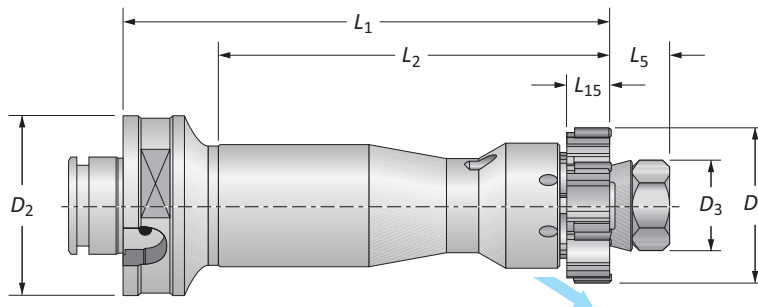

D ₁ Range		Mandrel					Shank		Teeth	Part No. (Complete Mandrel*)
Imperial (inch)	Metric (mm)	D ₃	L ₅	L ₁₅	L ₂	L ₁	D ₂			
0.6929 - 0.8503	17.60 - 21.59	12	11	11	81	116	50	6	4350-MC-010	
0.8504 - 1.0078	21.60 - 25.59	12	11	12	81	116	50	6	4350-MC-020	
1.0079 - 1.2834	25.60 - 32.59	15.6	11	14	102	137	50	6	4350-MC-030	
1.2835 - 1.5983	32.60 - 40.59	22	14	16	102	137	50	6	4350-MC-040	
1.5984 - 1.7952	40.60 - 45.59	25.4	15	16	102	137	50	6	4350-MC-050	
1.7953 - 1.9527	45.60 - 49.59	30	20.5	18.5	105	140	50	6	4350-MC-060	
1.9528 - 2.3857	49.60 - 60.59	30	20.5	18.5	105	140	50	6	4350-MC-070	
2.3858 - 2.7794	60.60 - 70.59	40	24.5	18.5	105	140	63	6	4350-MC-080	
2.7795 - 3.1338	70.60 - 79.59	40	24.5	18.5	105	140	63	6	4350-MC-090	
3.1339 - 3.5668	79.60 - 90.59	56	28.5	18.5	105	140	63	8	4350-MC-100	
3.5669 - 3.9602	90.60 - 100.59	56	28.5	18.5	105	140	63	8	4350-MC-110	

*Complete mandrel does not include cutting ring.

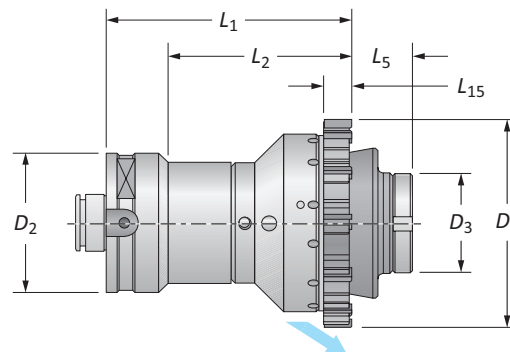

D ₁ Range		Mandrel					Shank		Teeth	Part No. (Complete Mandrel*)
Imperial (inch)	Metric (mm)	D ₃	L ₅	L ₁₅	L ₂	L ₁	D ₂			
3.9603 - 4.3539	100.60 - 110.59	73.8	35.5	18.5	-	140	80	10	4350-MC-120	
4.3540 - 4.5508	110.60 - 115.59	80.8	35.5	18.5	-	140	80	12	4350-MC-130	
4.5509 - 4.7476	115.60 - 120.59	86.8	35.5	18.5	-	140	80	12	4350-MC-140	
4.7477 - 4.9445	120.60 - 125.59	86.8	35.5	18.5	-	140	80	12	4350-MC-150	
4.9446 - 5.2201	125.60 - 132.59	90.8	35.5	18.5	-	140	80	12	4350-MC-160	
5.2202 - 5.4957	132.60 - 139.59	90.8	35.5	18.5	-	140	80	12	4350-MC-170	
5.4958 - 5.7319	139.60 - 145.59	102.8	35.5	18.5	-	140	80	12	4350-MC-180	
5.7320 - 6.1256	145.60 - 155.59	107.8	35.5	18.5	-	140	80	12	4350-MC-190	
6.1257 - 6.5193	155.60 - 165.59	107.8	48.5	18.5	-	140	80	12	4350-MC-200	
6.5194 - 6.9130	165.60 - 175.59	117.8	48.5	18.5	-	140	80	12	4350-MC-210	
6.9131 - 7.3067	175.60 - 185.59	127.8	48.5	18.5	-	140	80	12	4350-MC-220	
7.3068 - 7.7004	185.60 - 195.59	137.8	48.5	18.5	-	140	80	12	4350-MC-230	
7.7005 - 7.8972	195.60 - 200.59	145.8	48.5	18.5	-	140	80	12	4350-MC-240	

*Complete mandrel does not include cutting ring.

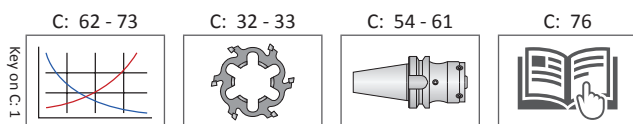

i = Imperial (in)
m = Metric (mm)



Ring Style Mandrels

4350 Series | Standard Length | Spare Parts

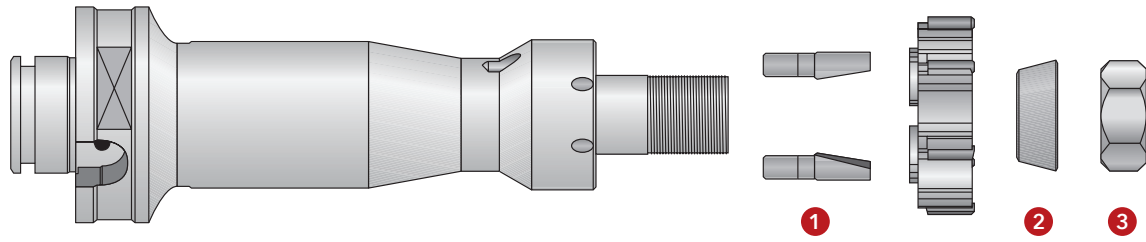

Part No. (Complete Mandrel*)	Spare Parts					Wrench Size (mm)
	1 Drive Pins	Number of Drive Pins	2 Conical Ring	3 Nut		
4350-MC-010	2000-CO-010	3	2010-AC-010	2000-DA-010	10	
4350-MC-020	2000-CO-020	3	2010-AC-010	2000-DA-010	10	
4350-MC-030	2000-CO-030	3	2010-AC-020	2000-DA-020	13	
4350-MC-040	2000-CO-040	2	2010-AC-030	2000-DA-060	19	
4350-MC-050	2000-CO-060	2	2010-AC-040	2000-DA-090	22	
4350-MC-060	2000-CO-060	2	2010-AC-050	2000-GH-880	30 ♦	
4350-MC-070	2000-CO-070	2	2010-AC-050	2000-GH-880	30 ♦	
4350-MC-080	2000-CO-080	2	2010-AC-060	2000-GH-900	40 ♦	
4350-MC-090	2000-CO-090	2	2010-AC-060	2000-GH-900	40 ♦	
4350-MC-100	2000-CO-090	2	2010-AC-070	2000-GH-920	56 ♦	
4350-MC-110	2000-CO-090	2	2010-AC-070	2000-GH-920	56 ♦	

*Complete mandrel does not include cutting ring.

♦ Spanner wrench

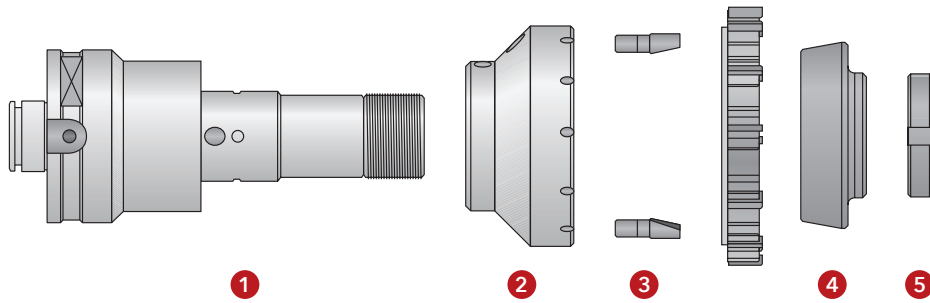

Part No. (Complete Mandrel*)	Spare Parts							Wrench Size (mm)
	1 Mandrel	2 Flange	3 Drive Pins	Number of Drive Pins	4 Conical Ring	5 Nut		
4350-MC-120	4350-MA-120	4355-FL-035	2000-CO-090	2	2060-BU-010	2000-GH-095	58 ♦	
4350-MC-130	4350-MA-120	4355-FL-045	2000-CO-090	2	2060-BU-020	2000-GH-095	58 ♦	
4350-MC-140	4350-MA-120	4355-FL-055	2000-CO-090	2	2060-BU-030	2000-GH-095	58 ♦	
4350-MC-150	4350-MA-120	4355-FL-065	2000-CO-090	2	2060-BU-030	2000-GH-095	58 ♦	
4350-MC-160	4350-MA-120	4355-FL-075	2000-CO-100	2	2060-BU-040	2000-GH-095	58 ♦	
4350-MC-170	4350-MA-120	4355-FL-085	2000-CO-100	2	2060-BU-040	2000-GH-095	58 ♦	
4350-MC-180	4350-MA-120	4355-FL-095	2000-CO-100	2	2060-BU-050	2000-GH-095	58 ♦	
4350-MC-190	4350-MA-120	4355-FL-105	2000-CO-110	2	2060-BU-060	2000-GH-095	58 ♦	
4350-MC-200	4350-MA-200	4355-FL-115	2000-CO-110	2	2060-BU-070	2000-GH-120	90 ♦	
4350-MC-210	4350-MA-200	4355-FL-125	2000-CO-110	2	2060-BU-080	2000-GH-120	90 ♦	
4350-MC-220	4350-MA-200	4355-FL-135	2000-CO-120	2	2060-BU-090	2000-GH-120	90 ♦	
4350-MC-230	4350-MA-200	4355-FL-145	2000-CO-120	2	2060-BU-100	2000-GH-120	90 ♦	
4350-MC-240	4350-MA-200	4355-FL-155	2000-CO-120	2	2060-BU-110	2000-GH-120	90 ♦	

*Complete mandrel does not include cutting ring.

♦ Spanner wrench

1 = Imperial (in)

M = Metric (mm)

Ring Style Mandrels

4355 Series | Standard Length | Diameter Range: 0.6929" - 7.8972 (17.60mm - 200.59mm)

Series	4355
Shank Type	Modular
Application	Blind Holes
Coolant	Radial

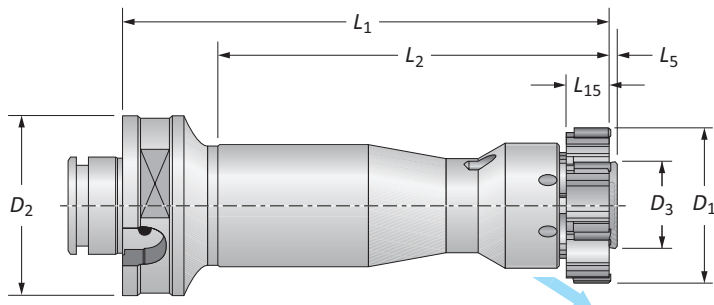

D ₁ Range		Mandrel					Shank		Teeth	Part No. (Complete Mandrel*)
Imperial (inch)	Metric (mm)	D ₃	L ₅	L ₁₅	L ₂	L ₁	D ₂			
0.6929 - 0.8503	17.60 - 21.59	11.2	1	11	81	116	50	6	4355-MC-010	
0.8504 - 1.0078	21.60 - 25.59	11.2	1	12	81	116	50	6	4355-MC-020	
1.0079 - 1.1653	25.60 - 29.59	15.1	1	14	102	137	50	6	4355-MC-030	
1.1654 - 1.2834	29.60 - 32.59	15.1	1	14	102	137	50	6	4355-MC-035	
1.2835 - 1.4408	32.60 - 36.59	20.3	1	16	102	137	50	6	4355-MC-040	
1.4409 - 1.5983	36.60 - 40.59	20.3	1	16	102	137	50	6	4355-MC-045	
1.5984 - 1.7952	40.60 - 45.59	24.1	1	16	102	137	50	6	4355-MC-050	
m 1.7953 - 1.9527	45.60 - 49.59	27.9	1.5	18.5	105	140	50	6	4355-MC-060	
1.9528 - 2.1889	49.60 - 55.59	27.9	1.5	18.5	105	140	50	6	4355-MC-070	
2.1890 - 2.3857	55.60 - 60.59	27.9	1.5	18.5	105	140	50	6	4355-MC-075	
2.3858 - 2.5826	60.60 - 65.59	37.1	1.5	18.5	105	140	63	6	4355-MC-080	
2.5827 - 2.7794	65.60 - 70.59	37.1	1.5	18.5	105	140	63	6	4355-MC-085	
2.7795 - 3.1338	70.60 - 79.59	37.1	1.5	18.5	105	140	63	6	4355-MC-090	
3.1339 - 3.5668	79.60 - 90.59	53.1	1.5	18.5	105	140	63	8	4355-MC-100	
3.5669 - 3.9602	90.60 - 100.59	53.1	1.5	18.5	105	140	63	8	4355-MC-110	

*Complete mandrel does not include cutting ring.

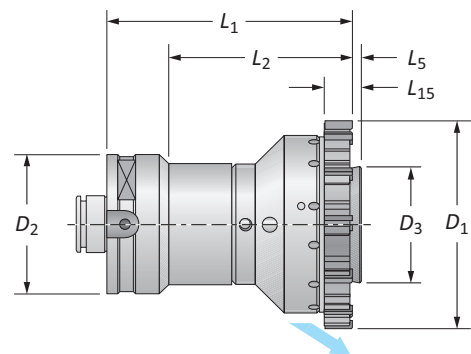

D ₁ Range		Mandrel					Shank		Teeth	Part No. (Complete Mandrel*)
Imperial (inch)	Metric (mm)	D ₃	L ₅	L ₁₅	L ₂	L ₁	D ₂			
3.9603 - 4.3539	100.60 - 110.59	70.3	1.5	18.5	-	140	80	10	4355-MC-120	
4.3540 - 4.5508	110.60 - 115.59	76.3	1.5	18.5	-	140	80	12	4355-MC-130	
4.5509 - 4.7476	115.60 - 120.59	83.3	1.5	18.5	-	140	80	12	4355-MC-140	
4.7477 - 4.9445	120.60 - 125.59	87.3	1.5	18.5	-	140	80	12	4355-MC-150	
4.9446 - 5.2201	125.60 - 132.59	87.3	1.5	18.5	-	140	80	12	4355-MC-160	
5.2202 - 5.4957	132.60 - 139.59	87.3	1.5	18.5	-	140	80	12	4355-MC-170	
m 5.4958 - 5.7319	139.60 - 145.59	99.3	1.5	18.5	-	140	80	12	4355-MC-180	
5.7320 - 6.1256	145.60 - 155.59	104.3	1.5	18.5	-	140	80	12	4355-MC-190	
6.1257 - 6.5193	155.60 - 165.59	104.3	1.5	18.5	-	140	80	12	4355-MC-200	
6.5194 - 6.9130	165.60 - 175.59	114.3	1.5	18.5	-	140	80	12	4355-MC-210	
6.9131 - 7.3067	175.60 - 185.59	124.3	1.5	18.5	-	140	80	12	4355-MC-220	
7.3068 - 7.7004	185.60 - 195.59	134.3	1.5	18.5	-	140	80	12	4355-MC-230	
7.7005 - 7.8972	195.60 - 200.59	142.3	1.5	18.5	-	140	80	12	4355-MC-240	

*Complete mandrel does not include cutting ring.

C: 62 - 73

C: 32 - 33

C: 54 - 61

C: 76

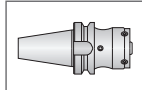
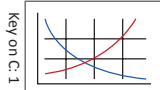

i = Imperial (in)
m = Metric (mm)



Ring Style Mandrels

4355 Series | Standard Length | Spare Parts

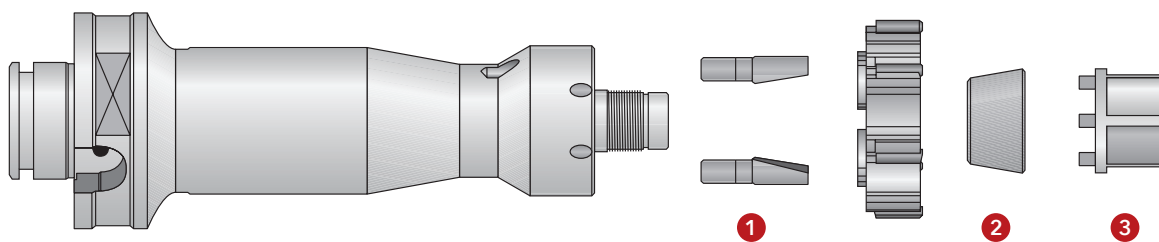

Part No. (Complete Mandrel*)	Spare Parts							Wrench Size (mm)
	1 Drive Pins	Number of Drive Pins	2 Conical Ring	Conical Ring (2nd Expansion)	Conical Ring (3rd Expansion)	3 Adjusting Key		
4355-MC-010	2000-CO-010	3	4001-AC-115	4001-AC-215	-	4001-CH-015	10	
4355-MC-020	2000-CO-020	3	4001-AC-115	4001-AC-215	-	4001-CH-015	10	
4355-MC-030	2000-CO-030	3	4001-AC-125	4001-AC-225	4001-AC-325	4001-CH-025	13	
4355-MC-035	2000-CO-040	2	4001-AC-125	4001-AC-225	4001-AC-325	4001-CH-025	13	
4355-MC-040	2000-CO-040	2	4001-AC-135	4001-AC-235	4001-AC-335	4001-CH-035	18	
4355-MC-045	2000-CO-050	2	4001-AC-135	4001-AC-235	4001-AC-335	4001-CH-035	18	
4355-MC-050	2000-CO-060	2	4001-AC-145	4001-AC-245	4001-AC-345	4001-CH-045	22	
4355-MC-060	2000-CO-060	2	4001-AC-155	4001-AC-255	4001-AC-355	4001-CH-055	26	
4355-MC-070	2000-CO-070	2	4001-AC-155	4001-AC-255	4001-AC-355	4001-CH-055	26	
4355-MC-075	2000-CO-080	2	4001-AC-155	4001-AC-255	4001-AC-355	4001-CH-055	26	
4355-MC-080	2000-CO-080	2	4001-AC-165	4001-AC-265	4001-AC-365	4001-CH-065	34	
4355-MC-085	2000-CO-090	2	4001-AC-165	4001-AC-265	4001-AC-365	4001-CH-065	34	
4355-MC-090	2000-CO-090	2	4001-AC-165	4001-AC-265	4001-AC-365	4001-CH-065	34	
4355-MC-100	2000-CO-090	2	4001-AC-185	4001-AC-285	4001-AC-385	4001-CH-085	46	
4355-MC-110	2000-CO-090	2	4001-AC-185	4001-AC-285	4001-AC-385	4001-CH-085	46	

*Complete mandrel does not include cutting ring.

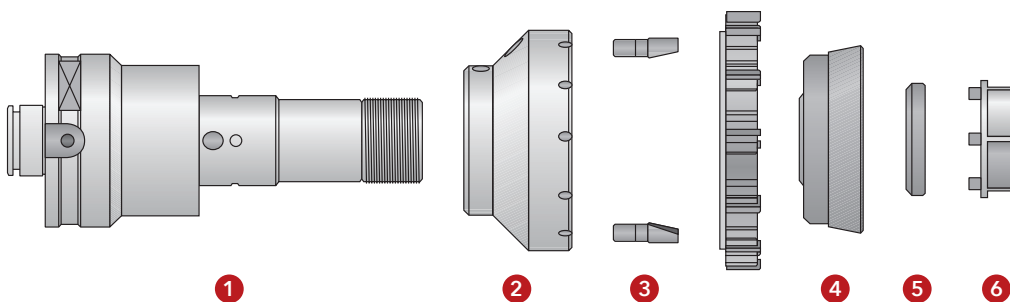

Part No. (Complete Mandrel*)	Spare Parts							Wrench Size (mm)
	1 Mandrel	2 Flange	3 Drive Pins	Number of Drive Pins	4 Conical Ring	5 Nut	6 Adjusting Key	
4355-MC-120	4355-MA-120	4355-FL-035	2000-CO-090	2	4001-AC-116	4001-GH-035	4001-CH-135	46
4355-MC-130	4355-MA-120	4355-FL-045	2000-CO-090	2	4001-AC-126	4001-GH-035	4001-CH-135	46
4355-MC-140	4355-MA-120	4355-FL-055	2000-CO-090	2	4001-AC-136	4001-GH-035	4001-CH-135	46
4355-MC-150	4355-MA-120	4355-FL-065	2000-CO-090	2	4001-AC-136	4001-GH-035	4001-CH-135	46
4355-MC-160	4355-MA-120	4355-FL-075	2000-CO-100	2	4001-AC-146	4001-GH-035	4001-CH-135	46
4355-MC-170	4355-MA-120	4355-FL-085	2000-CO-100	2	4001-AC-146	4001-GH-035	4001-CH-135	46
4355-MC-180	4355-MA-120	4355-FL-095	2000-CO-100	2	4001-AC-156	4001-GH-035	4001-CH-135	46
4355-MC-190	4355-MA-120	4355-FL-105	2000-CO-110	2	4001-AC-166	4001-GH-035	4001-CH-135	46
4355-MC-200	4355-MA-200	4355-FL-115	2000-CO-110	2	4001-AC-176	4001-GH-115	4001-CH-115	46
4355-MC-210	4355-MA-200	4355-FL-125	2000-CO-110	2	4001-AC-186	4001-GH-115	4001-CH-115	46
4355-MC-220	4355-MA-200	4355-FL-135	2000-CO-120	2	4001-AC-196	4001-GH-115	4001-CH-115	46
4355-MC-230	4355-MA-200	4355-FL-145	2000-CO-120	2	4001-AC-117	4001-GH-115	4001-CH-115	46
4355-MC-240	4355-MA-200	4355-FL-155	2000-CO-120	2	4001-AC-127	4001-GH-115	4001-CH-115	46

*Complete mandrel does not include cutting ring.

ⓘ = Imperial (in)
Ⓜ = Metric (mm)

Ring Style Mandrels

4300 Series | Long Length | Diameter Range: 0.6929" - 3.9602 (17.60mm - 100.59mm)

Series	4300
Shank Type	Modular
Application	Through Holes
Coolant	Radial

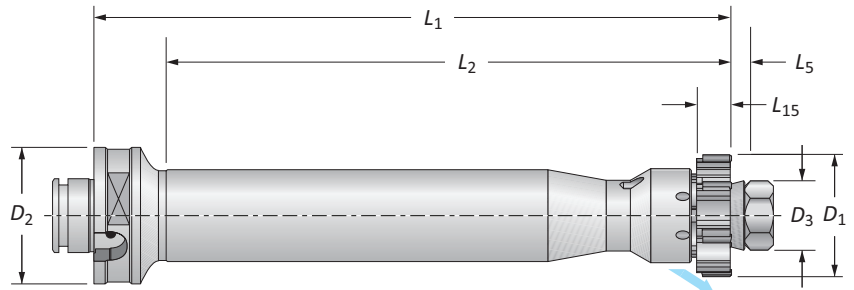

D ₁ Range		Mandrel							Teeth	Part No. (Complete Mandrel*)
Imperial (inch)	Metric (mm)	D ₃	L ₅	L ₁₅	L ₂	L ₁	D ₂			
0.6929 - 0.8503	17.60 - 21.59	12	11	11	121	156	50	6	4300-MC-010	
0.8504 - 1.0078	21.60 - 25.59	12	11	12	121	156	50	6	4300-MC-020	
1.0079 - 1.2834	25.60 - 32.59	15.6	11	14	153	188	50	6	4300-MC-030	
1.2835 - 1.5983	32.60 - 40.59	22	14	16	179	214	50	6	4300-MC-040	
1.5984 - 1.7952	40.60 - 45.59	25.4	15	16	201	236	50	6	4300-MC-050	
m 1.7953 - 1.9527	45.60 - 49.59	30	20.5	18.5	214	249	50	6	4300-MC-060	
1.9528 - 2.3857	49.60 - 60.59	30	20.5	18.5	214	249	50	6	4300-MC-070	
2.3858 - 2.7794	60.60 - 70.59	40	24.5	18.5	237	272	63	6	4300-MC-080	
2.7795 - 3.1338	70.60 - 79.59	40	24.5	18.5	237	272	63	6	4300-MC-090	
3.1339 - 3.5668	79.60 - 90.59	56	28.5	18.5	245	280	63	8	4300-MC-100	
3.5669 - 3.9602	90.60 - 100.59	56	28.5	18.5	245	280	63	8	4300-MC-110	

*Complete mandrel does not include cutting ring.

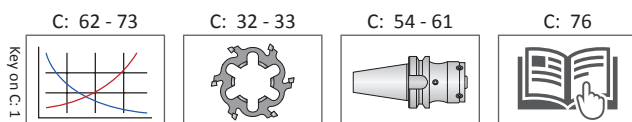

i = Imperial (in)
m = Metric (mm)



Ring Style Mandrels

4300 Series | Long Length | Spare Parts

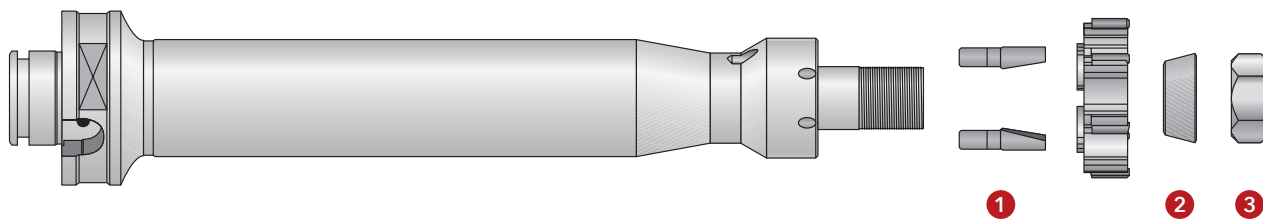

Part No. (Complete Mandrel*)	Spare Parts					Wrench Size (mm)
	1 Drive Pins	Number of Drive Pins	2 Conical Ring	3 Nut		
4300-MC-010	2000-CO-010	3	2010-AC-010	2000-DA-010	10	
4300-MC-020	2000-CO-020	3	2010-AC-010	2000-DA-010	10	
4300-MC-030	2000-CO-030	3	2010-AC-020	2000-DA-020	13	
4300-MC-040	2000-CO-040	2	2010-AC-030	2000-DA-060	19	
4300-MC-050	2000-CO-060	2	2010-AC-040	2000-DA-090	22	
4300-MC-060	2000-CO-060	2	2010-AC-050	2000-GH-880	30	
4300-MC-070	2000-CO-070	2	2010-AC-050	2000-GH-880	30	
4300-MC-080	2000-CO-080	2	2010-AC-060	2000-GH-900	40	
4300-MC-090	2000-CO-090	2	2010-AC-060	2000-GH-900	40	
4300-MC-100	2000-CO-090	2	2010-AC-070	2000-GH-920	56	
4300-MC-110	2000-CO-090	2	2010-AC-070	2000-GH-920	56	

*Complete mandrel does not include cutting ring.

Ⓜ

Ⓜ = Imperial (in)
Ⓜ = Metric (mm)

Ring Style Mandrels

4305 Series | Long Length | Diameter Range: 0.6929" - 3.9602 (17.60mm - 100.59mm)

Series	4305
Shank Type	Modular
Application	Blind Holes
Coolant	Radial

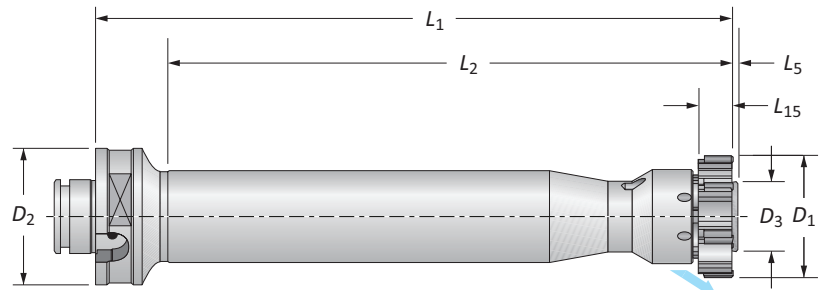

D ₁ Range		Mandrel					Teeth	Part No. (Complete Mandrel*)
Imperial (inch)	Metric (mm)	L ₅	L ₁₅	L ₂	L ₁	D ₂		
0.6929 - 0.8503	17.60 - 21.59	1	11	121	156	50	6	4305-MC-010
0.8504 - 1.0078	21.60 - 25.59	1	12	121	156	50	6	4305-MC-020
1.0079 - 1.1653	25.60 - 29.59	1	14	153	188	50	6	4305-MC-030
1.1654 - 1.2834	29.60 - 32.59	1	14	153	188	50	6	4305-MC-035
1.2835 - 1.4408	32.60 - 36.59	1	16	179	214	50	6	4305-MC-040
1.4409 - 1.5983	36.60 - 40.59	1	16	179	214	50	6	4305-MC-045
1.5984 - 1.7952	40.60 - 45.59	1	16	201	236	50	6	4305-MC-050
m 1.7953 - 1.9527	45.60 - 49.59	1.5	18.5	214	249	50	6	4305-MC-060
1.9528 - 2.1889	49.60 - 55.59	1.5	18.5	214	249	50	6	4305-MC-070
2.1890 - 2.3857	55.60 - 60.59	1.5	18.5	214	249	50	6	4305-MC-075
2.3858 - 2.5826	60.60 - 65.59	1	18.5	237	272	63	6	4305-MC-080
2.5827 - 2.7794	65.60 - 70.59	1	18.5	237	272	63	6	4305-MC-085
2.7795 - 3.1338	70.60 - 79.59	1	18.5	237	272	63	6	4305-MC-090
3.1339 - 3.5668	79.60 - 90.59	1.5	18.5	245	280	63	8	4305-MC-100
3.5669 - 3.9602	90.60 - 100.59	1.5	18.5	245	280	63	8	4305-MC-110

*Complete mandrel does not include cutting ring.

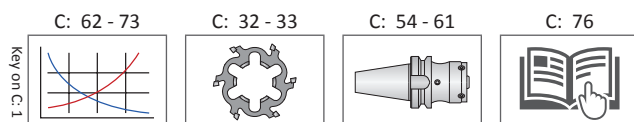

i = Imperial (in)
m = Metric (mm)



Ring Style Mandrels

4305 Series | Long Length | Spare Parts

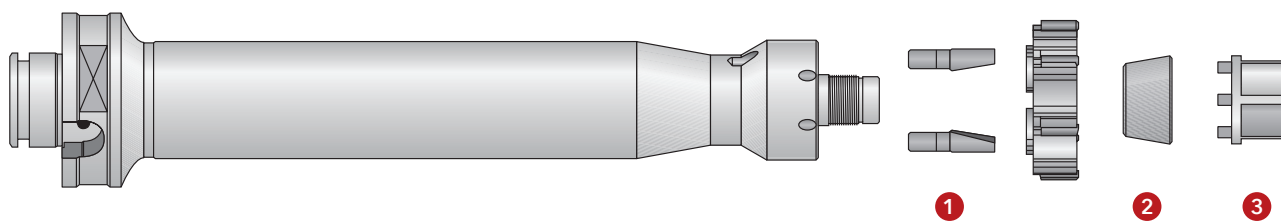

Part No. (Complete Mandrel*)	Spare Parts							Wrench Size (mm)
	1 Drive Pins	Number of Drive Pins	2 Conical Ring	Conical Ring (2nd Expansion)	Conical Ring (3rd Expansion)	3 Adjusting Key		
4305-MC-010	2000-CO-010	3	4001-AC-115	4001-AC-215	–	4001-CH-015	10	
4305-MC-020	2000-CO-020	3	4001-AC-115	4001-AC-215	–	4001-CH-015	10	
4305-MC-030	2000-CO-030	3	4001-AC-125	4001-AC-225	4001-AC-325	4001-CH-025	13	
4305-MC-035	2000-CO-040	2	4001-AC-125	4001-AC-225	4001-AC-325	4001-CH-025	13	
4305-MC-040	2000-CO-040	2	4001-AC-135	4001-AC-235	4001-AC-335	4001-CH-035	18	
4305-MC-045	2000-CO-050	2	4001-AC-135	4001-AC-235	4001-AC-335	4001-CH-035	18	
4305-MC-050	2000-CO-060	2	4001-AC-145	4001-AC-245	4001-AC-345	4001-CH-045	22	
4305-MC-060	2000-CO-060	2	4001-AC-155	4001-AC-255	4001-AC-355	4001-CH-055	26	
4305-MC-070	2000-CO-070	2	4001-AC-155	4001-AC-255	4001-AC-355	4001-CH-055	26	
4305-MC-075	2000-CO-080	2	4001-AC-155	4001-AC-255	4001-AC-355	4001-CH-055	26	
4305-MC-080	2000-CO-080	2	4001-AC-165	4001-AC-265	4001-AC-365	4001-CH-065	34	
4305-MC-085	2000-CO-090	2	4001-AC-165	4001-AC-265	4001-AC-365	4001-CH-065	34	
4305-MC-090	2000-CO-090	2	4001-AC-165	4001-AC-265	4001-AC-365	4001-CH-065	34	
4305-MC-100	2000-CO-090	2	4001-AC-185	4001-AC-285	4001-AC-385	4001-CH-085	46	
4305-MC-110	2000-CO-090	2	4001-AC-185	4001-AC-285	4001-AC-385	4001-CH-085	46	

*Complete mandrel does not include cutting ring.

Ⓜ

Ⓜ = Imperial (in)
Ⓜ = Metric (mm)

Radial Adjusting Shanks



Large range of shanks for different machine types



Highly adjustable for improved concentricity



All shanks are available with through coolant

All the Pieces You Need

Modular System courtesy of 

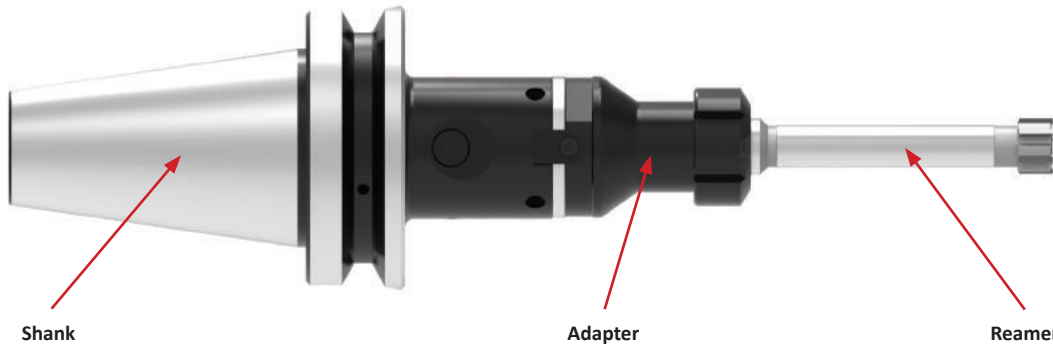

DIN 69871/1 B and A



HSK-A DIN 69893/1

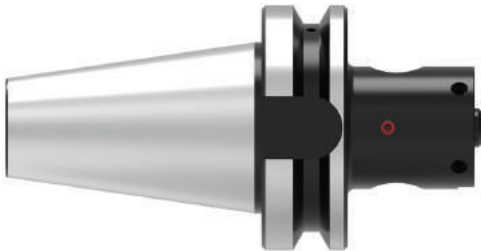

JMTBA MAS-403
BT B and BT



Straight



Collet Chuck Adapter



Cylindrical Shank
Adapter

Radial Adjusting Shanks

Set-up Information

Radial Adjusting Shanks and Ring Style Arbors

The following is a quick guide for setting up a radial adjusting shank and a ring style reamer. The ring reamer arbor does not contain the tang needed to connect to the shank. The tang must first be removed from the shank and then installed into the reamer arbor (demonstrated below).



Step 1:
The tang comes installed with the shank. Loosen the clamping screw on each side and remove the tang from the shank.

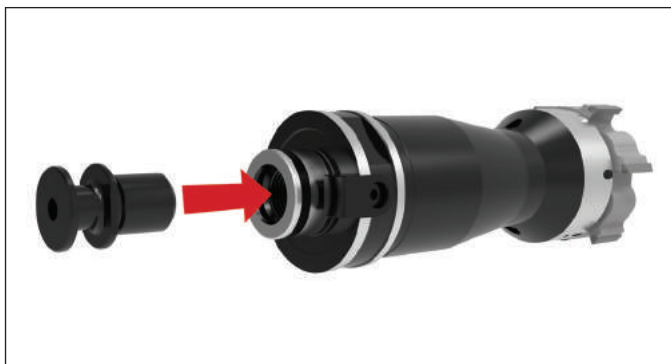

Step 2:
Thread the tang into the back end of the ring arbor. Use a bench vise and wrench to tighten.

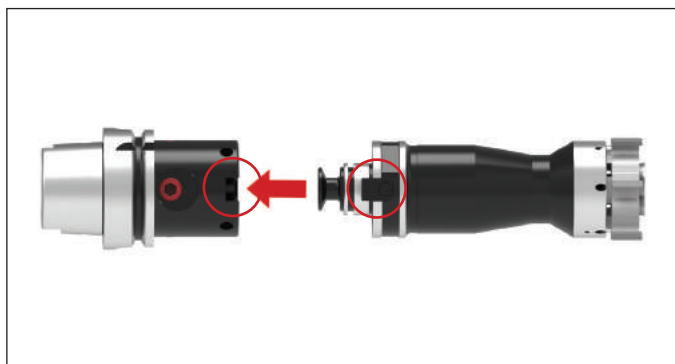

Step 3:
Assemble the ring arbor to the shank. With the clamping screws still loosened, align the key on the arbor to the keyway on the shank.



Step 4:
Once the ring arbor is connected with the shank, tighten the clamping screws to secure the tang back into place.

A

DRILLING

B

BORING

C

REAMING

D

BURNISHING

E

THREADING

X

SPECIALS

Radial Adjusting Shanks

DIN 69871/1 B and A

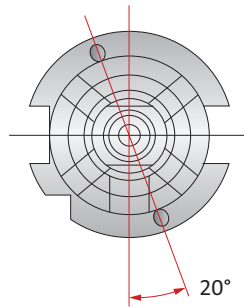

Maximum radial adjustment is ±0.008" (0.20mm) on diameter

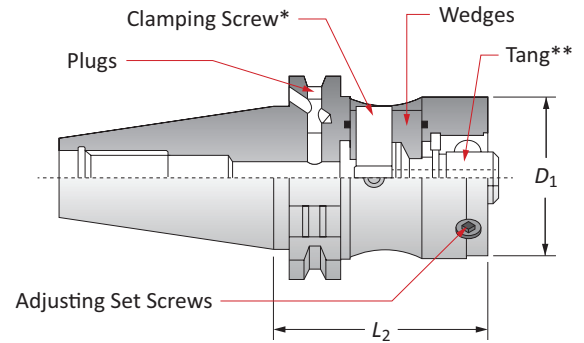

Shank				Spare Parts							
ISO Taper	D ₁	L ₂	Retention Knob Thread Size	Part No.	Wedges + O-Ring	Clamping Screw*	Adjusting Set Screws	Plugs	Replacement Tang**	Clamping Screw Key	
40	50	65	M16 x 2	02B.40.50L.65	ATR14102.2.3	ATR14102.1	M8x1x10G	M5x5TG	ATT14103	6mm	
40	63	85	M16 x 2	02B.40.63L.85	ATR14108.2.3	ATR14108.1	M8x1x14G	M5x5TG	ATT14104	6mm	
45	50	70	M20 x 2.5	02B.45.50L.70	ATR14102.2.3	ATR14102.1	M8x1x10G	M5x5TG	ATT14103	6mm	
45	63	70	M20 x 2.5	02B.45.63L.70	ATR14108.2.3	ATR14108.1	M8x1x14G	M5x5TG	ATT14104	6mm	
50	50	70	M24 x 3	02B.50.50L.70	ATR14102.2.3	ATR14102.1	M8x1x10G	M5x5TG	ATT14103	6mm	
50	63	70	M24 x 3	02B.50.63L.70	ATR14108.2.3	ATR14108.1	M8x1x14G	M5x5TG	ATT14104	6mm	
50	80	70	M24 x 3	❖ 02B.50.80L.70	ATR18775.2.3	ATR18775.1	M8x1x20G	M5x5TG	ATT14104	6mm	

* Light torque exerted on the clamping screw transmits high axial forces, which provide stiffness and extreme accuracy to the assembly.

** Tang must be fitted to all reamer arbors and adapters prior to assembly.

❖ Could cause interference with tool changer mechanism.

NOTE: Shanks can be converted into DIN 69871/1A coolant by screwing the two plugs clockwise to the end of their stroke.

C: 55



Key on C: 1

Modular System courtesy of 

Reference Key

Symbol	Attribute
D ₁	Modular shank size
L ₂	Gage length

A DRILLING
B BORING
C REAMING
D BURNISHING
E THREADING
X SPECIALS



Radial Adjusting Shanks

JMTBA MAS-403 BT B and BT

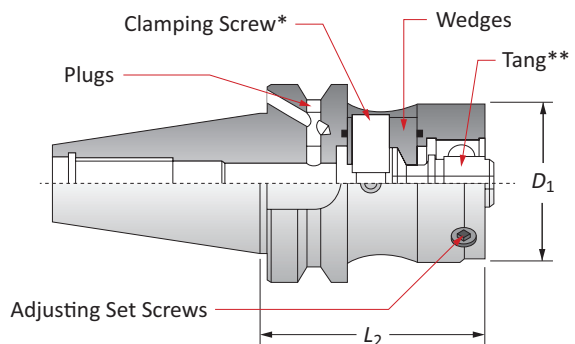
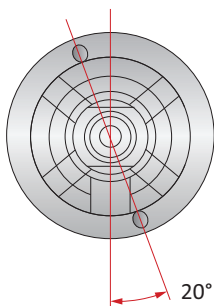

Maximum radial adjustment is $\pm 0.008''$ (0.20mm) on diameter.

Shank				Spare Parts							
BT Taper	D_1	L_2	Retention Knob Thread Size	Part No.	Wedges + O-ring	Clamping Screw*	Adjusting Set Screws	Plugs	Replacement Tang**	Clamping Screw Key	
40	50	70	M16 x 2	BTB.40.50L.70	ATR14102.2.3	ATR14102.1	M8x1x10G	M5x5TG	ATT14103	6mm	
40	63	80	M16 x 2	BTB.40.63L.80	ATR14108.2.3	ATR14108.1	M8x1x14G	M5x5TG	ATT14104	6mm	
50	50	90	M24 x 3	BTB.50.50L.90	ATR14102.2.3	ATR14102.1	M8x1x10G	M5x5TG	ATT14103	6mm	
50	63	90	M24 x 3	BTB.50.63L.90	ATR14108.2.3	ATR14108.1	M8x1x14G	M5x5TG	ATT14104	6mm	
50	80	90	M24 x 3	BTB.50.80L.90	ATR18775.2.3	ATR18775.1	M8x1x20G	M5x5TG	ATT14104	6mm	

* Light torque exerted on the clamping screw transmits high axial forces, which provide stiffness and extreme accuracy to the assembly.

** Tang must be fitted to all ring arbors and adapters prior to assembly.

NOTE: Shanks can be converted into MAS-403 BT coolant by screwing the two plugs clockwise to the end of their stroke.

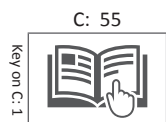

C: 55

Modular System courtesy of

Reference Key	
Symbol	Attribute
D_1	Modular shank size
L_2	Gage length

Radial Adjusting Shanks

HSK-A DIN 69893/1

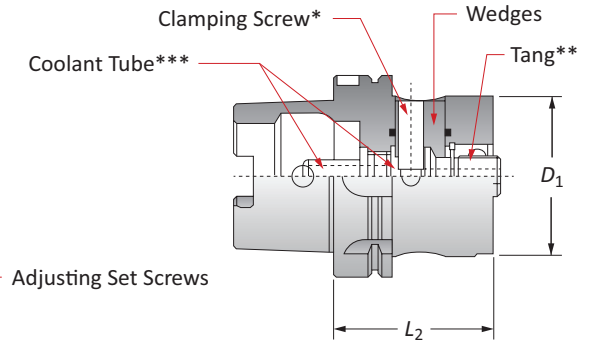
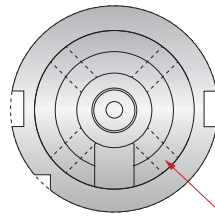

Shank			Spare Parts							
HSK	D_1	L_2	Part No.	Wedges + O-Ring	Clamping Screw*	Adjusting Set Screws	Replacement Tang**	Clamping Screw Key	Coolant Tube Key	Coolant Tube***
63	50	70	HSKA.63.50L.70	ATR14102.2.3	ATR14102.1	M8x1x10G	ATT14103	6mm	ATR23856	ATT23728
63	63	75	HSKA.63.63L.75	ATR.41613.4	ATR14108.1	M8x1x14G	ATT14104	6mm	ATR23856	ATT23728
100	50	80	HSKA.100.50L.80	ATR14102.2.3	ATR14102.1	M8x1x10G	ATT14103	6mm	ATR23856	ATT23656
100	63	80	HSKA.100.63L.80	ATR14108.2.3	ATR14108.1	M8x1x14G	ATT14104	6mm	ATR23856	ATT23656
100	80	80	HSKA.100.80L.80	ATR18775.2.3	ATR18775.1	M8x1x10G	ATT14104	6mm	ATR23856	ATT23656

* Light torque exerted on the clamping screw transmits high axial forces, which provide stiffness and extreme accuracy to the assembly.

** Tang must be fitted to all ring arbors and adapters prior to assembly.

*** Coolant tube sold separately.

C: 55



Key on C: 1

Modular System courtesy of 

Reference Key

Symbol	Attribute
D_1	Modular shank size
L_2	Gage length

A DRILLING
B BORING
C REAMING
D BURNISHING
E THREADING
X SPECIALS



Radial Adjusting Shanks

Straight

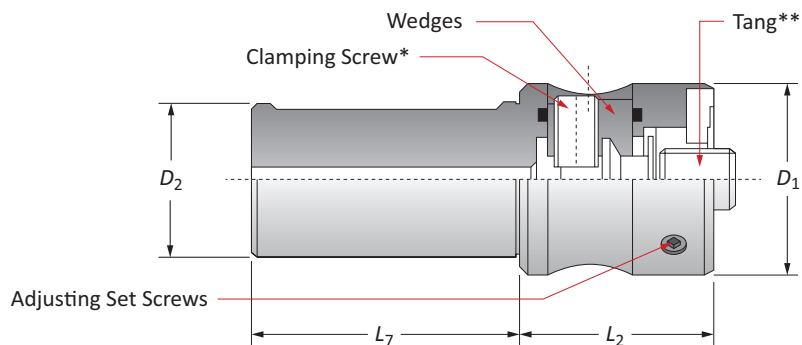

Shank				Spare Parts					
D_1	D_2	L_2	L_7	Part No.	Wedges + O-Ring	Clamping Screw*	Adjusting Set Screws	Replacement Tang**	Clamping Screw Key
50	25	50	70	CIL.25.50.50	ATR14102.2.3	ATR14102.1	M8x1x10G	ATT14103	6mm
50	32	50	70	CIL.32.50.50	ATR14102.2.3	ATR14102.1	M8x1x10G	ATT14103	6mm
50	40	50	70	CIL.40.50.50	ATR14102.2.3	ATR14102.1	M8x1x10G	ATT14103	6mm

* Light torque exerted on the clamping screw transmits high axial forces, which provide stiffness and extreme accuracy to the assembly.

** Tang must be fitted to all ring arbors and adapters prior to assembly.

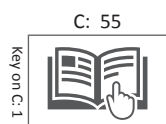

C: 55

Modular System courtesy of CERIT

Reference Key	
Symbol	Attribute
D_1	Modular shank size
D_2	Shank diameter
L_2	Gage length
L_7	Shank length

Radial Adjusting Adapters

Collet Chuck Adapters | Cylindrical Shank Adapters

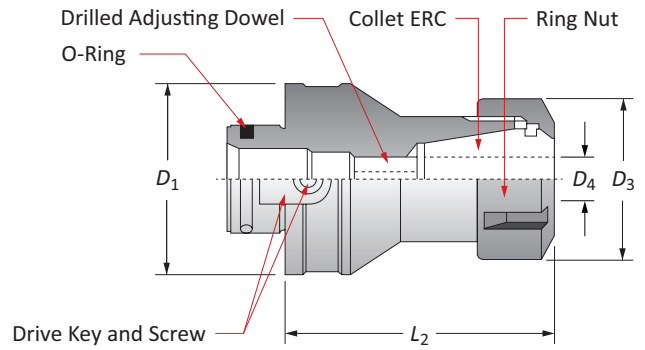

Collet Sleeve Size*	Adapter				Part No.	Spare Parts					
	D_1	D_3	D_4	L_2		Clamping Screw	Ring Nut	Adjusting Dowel	Drive Key	Ring Nut Wrench	Adjusting Dowel Key
ERC25	42	50	0.5 - 16mm	70	30.50R.25.70	M4x8V	G25S	M12x16GF	TAB3924	CH25S	6mm
ERC32	50	50	1 - 20mm	70	30.50R.32.70	M4x8V	G32S	M16x15x18GF	TAB3924	CH32S	8mm
ERC32	50	63	1 - 20mm	90	30.63R.32.90	M6x12V	G32S	M12x16GF	TAB3923.1	CH32S	6mm
ERC40	63	63	2 - 30mm	90	30.63R.40.90	M6x12V	G40S	M20x2x20GF	TAB3923.1	CH40S	10mm
ERC32	50	80	1 - 20mm	90	30.80R.32.90	M6x16V	G32S	M12x16GF	TAB3923.2	CH32S	6mm
ERC40	63	80	2 - 30mm	90	30.80R.40.90	M6x16V	G40S	M20x2x20GF	TAB3923.2	CH40S	10mm

*Collet sleeve not included

Reference Key

Symbol	Attribute
D_1	Modular shank size
D_3	Body diameter
D_4	Shank diameter
L_2	Gage length

C: 55



Modular System courtesy of 

Radial Adjusting Adapters

Collet Chuck Adapters | Cylindrical Shank Adapters

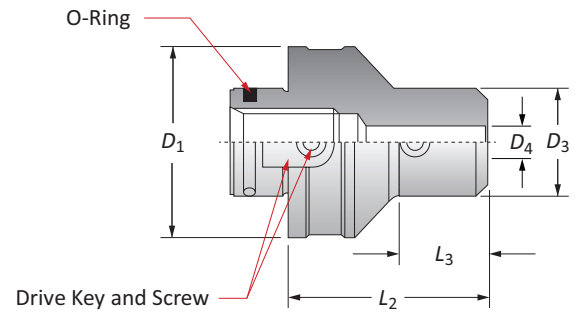

Adapter					Spare Parts				
D_1	D_4	D_3	L_2	L_3	Part No.	Drive Key	Screw	Set Screw	Set Screw Key
50	6	25	50	22.5	35.50R.06.50	TAB3924	M4x8V	M6x8G	3mm
50	8	28	50	24.5	35.50R.08.50	TAB3924	M4x8V	M6x8G	4mm
50	10	35	50	26.5	35.50R.10.50	TAB3924	M4x8V	M10x10G	5mm
50	12	42	60	38.5	35.50R.12.60	TAB3924	M4x8V	M12x12G	6mm
50	14	44	60	42	35.50R.14.60	TAB3924	M4x8V	M12x12G	6mm
50	16	48	60	40	35.50R.16.60	TAB3924	M4x8V	M14x14G	6mm
50	18	50	60	-	35.50R.18.60	TAB3924	M4x8V	M14x14G	6mm
50	20	52	60	41	35.50R.20.60	TAB3924	M4x8V	M16x2x14G	8mm
63	8	28	60	28	35.63R.08.60	TAB3923.1	M6x12V	M8x8G	4mm
63	10	35	70	40	35.63R.10.70	TAB3923.1	M6x12V	M10x10G	5mm
63	12	42	70	42	35.63R.12.70	TAB3923.1	M6x12V	M12x12G	6mm
63	14	44	60	32	35.63R.14.60	TAB3923.1	M6x12V	M12x12G	6mm
63	16	48	70	44	35.63R.16.70	TAB3923.1	M6x12V	M14x14G	6mm
63	18	50	70	40	35.63R.18.70	TAB3923.1	M6x12V	M14x14G	6mm
63	20	52	70	45	35.63R.20.70	TAB3923.1	M6x12V	M16x2x14G	8mm
50	25	65	80	61	40.50R.25.80	TAB3924	M4x8V	M18x2x18G	8mm
50	32	72	80	65	40.50R.32.80	TAB3924	M4x8V	M20x2x18G	10mm
63	25	65	80	58	40.63R.25.80	TAB3923.1	M6x12V	M18x2x18G	8mm
63	32	72	80	-	40.63R.32.80	TAB3923.1	M6x12V	M20x2x18G	10mm
80	25	65	80	50.5	40.80R.25.80	TAB3923.2	M6x12V	M18x2x18G	8mm
80	32	72	80	54	40.80R.32.80	TAB3923.2	M6x12V	M20x2x18G	10mm

Reference Key

Symbol	Attribute
D_1	Modular shank size
D_3	Body diameter
D_4	Shank diameter
L_2	Gage length
L_3	Reference length

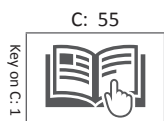

Modular System courtesy of 

Recommended Cutting Data | Imperial (inch)

Replaceable Head Style

ISO	Material	Hardness (BHN)	Speed (SFM)			Recommended Feed (IPR) by Reamer Diameter					
			Uncoated Carbide	Coated Carbide	Cermet	.4646 - .8504		.8505 - 1.5590		1.5591 - 2.3858	
						Lead A, G	Lead E, N, M	Lead A, G	Lead E, N, M	Lead A, G	Lead E, N, M
P	Free Machining Steel 1118, 1215, 12L14, etc.	100 - 180	35 - 65	200 - 260	300 - 980	.010 - .024	.020 - .024	.012 - .031	.024 - .047	.024 - .039	.028 - .059
		180 - 250	25 - 50	130 - 230	260 - 600	.012 - .024	.016 - .031	.016 - .031	.020 - .039	.020 - .035	.024 - .047
	Low Carbon Steel 1010, 1020, 1025, 1522, 1144, etc.	85 - 180	35 - 65	200 - 260	300 - 980	.010 - .024	.020 - .024	.012 - .031	.024 - .047	.024 - .039	.028 - .059
		180 - 275	25 - 50	130 - 230	260 - 600	.012 - .024	.016 - .031	.016 - .031	.020 - .039	.020 - .035	.024 - .047
	Medium Carbon Steel 1030, 1040, 1050, 1527, 1140, 1151, etc.	125 - 180	35 - 65	200 - 260	300 - 980	.010 - .024	.020 - .024	.012 - .031	.024 - .047	.024 - .039	.028 - .059
		180 - 325	25 - 50	130 - 230	260 - 600	.012 - .024	.016 - .031	.016 - .031	.020 - .039	.020 - .035	.024 - .047
	Alloy Steel 4140, 5140, 8640, etc.	125 - 180	25 - 50	130 - 230	260 - 600	.010 - .024	.020 - .024	.012 - .031	.024 - .047	.024 - .039	.028 - .059
		180 - 375	15 - 35	50 - 100	200 - 390	.012 - .024	.016 - .031	.016 - .031	.020 - .039	.020 - .035	.024 - .047
	High Strength Alloy 4340, 4330V, 300M, etc.	240 - 450	15 - 35	50 - 100	200 - 390	.010 - .020	.012 - .024	.012 - .024	.016 - .031	.016 - .028	.020 - .039
S	High Temp Alloy Hastelloy B, Inconel 600, etc.	140 - 310	20 - 50	60 - 200	-	.008 - .016	-	.012 - .020	-	.016 - .024	-
	Titanium Alloy	140 - 310	20 - 50	60 - 200	-	.008 - .016	-	.012 - .020	-	.016 - .024	-
M	Stainless Steel 400 Series 416, 420, etc.	135 - 350	20 - 35	100 - 160	200 - 490	.012 - .024	.016 - .031	.016 - .031	.020 - .039	.020 - .035	.024 - .047
	Stainless Steel 300 Series 304, 316, 17-4PH, etc.	135 - 275	20 - 35	100 - 160	200 - 490	.012 - .024	.016 - .031	.016 - .031	.020 - .039	.020 - .035	.024 - .047
K	Grey Cast Iron, Ductile Cast Iron,	< 200	65 - 130	160 - 230	-	.008 - .024	.020 - .039	.012 - .028	.024 - .047	.024 - .051	.031 - .063
	Spheroidal Cast Iron (Pearlitic)	> 200	50 - 100	160 - 230	-	.008 - .024	.020 - .039	.012 - .028	.024 - .047	.024 - .051	.031 - .063
	Spheroidal Cast Iron (Ferritic)	260 - 320	30 - 50	100 - 160	200 - 400	.008 - .024	.020 - .024	.012 - .028	.024 - .047	.016 - .031	.031 - .063
N	Copper and Alloys	< 500	200 - 660	330 - 660	-	.008 - .024	-	.012 - .028	-	.016 - .031	-
	Brass										
	Bronze	< 180	65 - 130	260 - 520	330 - 980	.012 - .024	.016 - .039	.012 - .024	.020 - .047	.012 - .024	.024 - .059
	Bronze Phosphorous										
	Aluminum and Alloys	< 150	65 - 660	-	-	.012 - .024	-	.016 - .039	-	.016 - .039	-

Formulas

<p>1. RPM = (SFM • 3.82) / DIA</p> <p>where:</p> <p>RPM = revolutions per minute (rev/min)</p> <p>SFM = speed (ft/min)</p> <p>DIA = diameter of reamer (inch)</p>	<p>2. IPM = RPM • IPR</p> <p>where:</p> <p>IPM = inches per minute (in/min)</p> <p>RPM = revolutions per minute (rev/min)</p> <p>IPR = feed rate (in/rev)</p>	<p>3. SFM = RPM • 0.262 • DIA</p> <p>where:</p> <p>SFM = speed (ft/min)</p> <p>RPM = revolutions per minute (rev/min)</p> <p>DIA = diameter of reamer (inch)</p>
--	--	---

IMPORTANT: The speeds and feeds listed on these pages are a general starting point for all applications. Factory technical assistance is available through our Application Engineering department.

Stock Allowance and Coolant | Imperial (inch)

Replaceable Head Style

ISO	Material	Hardness (BHN)	Coolant	Recommended Stock (inch) by Reamer Diameter*		
				.4646 - .8504	.8505 - 1.5590	1.5591 - 2.3858
P	Free Machining Steel 1118, 1215, 12L14, etc.	100 - 180	Water Soluble Cutting Oil	.006 - .010	.008 - .016	.012 - .016
		180 - 250				
	Low Carbon Steel 1010, 1020, 1025, 1522, 1144, etc.	85 - 180				
		180 - 275				
	Medium Carbon Steel 1030, 1040, 1050, 1527, 1140, 1151, etc.	125 - 180				
		180 - 325				
	Alloy Steel 4140, 5140, 8640, etc.	125 - 180				
		180 - 375				
	High Strength Alloy 4340, 4330V, 300M, etc.	240 - 450				
	Structural Steel A36, A285, A516	125 - 180				
	Tool Steel H-13, H-21, A-4, O-2, S-3, etc.	150 - 200				
		200 - 250				
S	High Temp Alloy Hastelloy B, Inconel 600, etc.	140 - 310	Water Soluble Cutting Oil	.006 - .010	.008 - .016	.012 - .016
	Titanium Alloy	140 - 310				
M	Stainless Steel 400 Series 416, 420, etc.	135 - 350	Water Soluble Cutting Oil	.006 - .010	.008 - .016	.012 - .016
	Stainless Steel 300 Series 304, 316, 17-4PH, etc.	135 - 275				
K	Grey Cast Iron, Ductile Cast Iron, Spheroidal Cast Iron (Pearlitic)	< 200	Water Soluble Cutting Oil	.006 - .010	.008 - .016	.012 - .016
	Spheroidal Cast Iron (Ferritic)	> 200				
		260 - 320				
N	Copper and Alloys	< 500	Water Soluble	.006 - .010	.008 - .016	.012 - .016
	Brass					
	Bronze	< 180	Water Soluble Cutting Oil			
	Bronze Phosphorous					
	Aluminum and Alloys	< 150	Water Soluble Cutting Oil			

*Stock value is on diameter.

A
DRILLING
B
BORING
C
REAMING
D
URNISHING
E
HREADING
X
PECIALS

Recommended Cutting Data | Imperial (inch)

Monobloc Style

ISO	Material	Hardness (BHN)	Speed (SFM)			Recommended Feed (IPR) by Reamer Diameter					
			Uncoated Carbide	Coated Carbide	Cermet	.2283 - .3940		.3941 - .7090		.7091 - 1.2638	
						Lead A, G	Lead E, N, M	Lead A, G	Lead E, N, M	Lead A, G	Lead E, N, M
P	Free Machining Steel 1118, 1215, 12L14, etc.	100 - 180	25 - 50	200 - 260	300 - 980	.008 - .016	.012 - .024	.016 - .024	.016 - .047	.020 - .031	.024 - .047
		180 - 250	20 - 35	130 - 230	260 - 660	.008 - .016	.012 - .020	.012 - .024	.012 - .031	.016 - .028	.016 - .047
	Low Carbon Steel 1010, 1020, 1025, 1522, 1144, etc.	85 - 180	25 - 50	200 - 260	300 - 980	.008 - .016	.012 - .024	.016 - .024	.016 - .047	.020 - .031	.024 - .047
		180 - 275	20 - 35	130 - 230	260 - 660	.008 - .016	.012 - .020	.012 - .024	.012 - .031	.016 - .028	.016 - .047
	Medium Carbon Steel 1030, 1040, 1050, 1527, 1140, 1151, etc.	125 - 180	25 - 50	200 - 260	300 - 980	.008 - .016	.012 - .024	.016 - .024	.016 - .047	.020 - .031	.024 - .047
		180 - 325	20 - 35	130 - 230	260 - 660	.008 - .016	.012 - .020	.012 - .024	.012 - .031	.016 - .028	.016 - .047
	Alloy Steel 4140, 5140, 8640, etc.	125 - 180	20 - 35	130 - 230	260 - 660	.008 - .016	.012 - .024	.016 - .024	.016 - .047	.020 - .031	.024 - .047
		180 - 375	15 - 25	100 - 160	200 - 490	.008 - .016	.012 - .020	.012 - .024	.012 - .031	.016 - .028	.016 - .047
	High Strength Alloy 4340, 4330V, 300M, etc.	240 - 450	10 - 20	50 - 100	200 - 390	.006 - .012	.008 - .016	.008 - .020	.012 - .024	.012 - .024	.016 - .031
S	High Temp Alloy Hastelloy B, Inconel 600, etc.	140 - 310	15 - 25	60 - 200	-	.006 - .012	-	.008 - .016	-	.012 - .020	-
	Titanium Alloy	140 - 310	15 - 25	60 - 200	-	.006 - .012	-	.008 - .016	-	.012 - .020	-
M	Stainless Steel 400 Series 416, 420, etc.	135 - 350	15 - 25	100 - 160	200 - 490	.008 - .016	.012 - .020	.012 - .024	.012 - .031	.016 - .028	.016 - .047
	Stainless Steel 300 Series 304, 316, 17-4PH, etc.	135 - 275	15 - 25	100 - 160	200 - 490	.008 - .016	.012 - .020	.012 - .024	.012 - .031	.016 - .028	.016 - .047
K	Grey Cast Iron, Ductile Cast Iron,	< 200	50 - 100	160 - 230	-	.008 - .016	.012 - .024	.014 - .024	.020 - .031	.016 - .047	.024 - .059
	Spheroidal Cast Iron (Pearlitic)	> 200	35 - 65	160 - 230	-	.008 - .016	.012 - .024	.014 - .024	.020 - .031	.016 - .047	.024 - .059
	Spheroidal Cast Iron (Ferritic)	260 - 320	25 - 40	100 - 160	200 - 400	.008 - .016	.012 - .024	.014 - .024	.020 - .031	.016 - .047	.024 - .059
N	Copper and Alloys	< 500	35 - 60	330 - 660	-	.008 - .016	-	.016 - .028	-	.020 - .031	-
	Brass										
	Bronze	< 180	35 - 65	260 - 520	330 - 980	.006 - .012	-	.008 - .016	-	.012 - .024	-
	Bronze Phosphorous										
	Aluminum and Alloys	< 150	50 - 100	330 - 660	-	.008 - .016	-	.016 - .028	-	.020 - .031	-

Formulas

<p>1. RPM = (SFM • 3.82) / DIA</p> <p>where:</p> <p>RPM = revolutions per minute (rev/min)</p> <p>SFM = speed (ft/min)</p> <p>DIA = diameter of reamer (inch)</p>	<p>2. IPM = RPM • IPR</p> <p>where:</p> <p>IPM = inches per minute (in/min)</p> <p>RPM = revolutions per minute (rev/min)</p> <p>IPR = feed rate (in/rev)</p>	<p>3. SFM = RPM • 0.262 • DIA</p> <p>where:</p> <p>SFM = speed (ft/min)</p> <p>RPM = revolutions per minute (rev/min)</p> <p>DIA = diameter of reamer (inch)</p>
--	--	---

IMPORTANT: The speeds and feeds listed on these pages are a general starting point for all applications. Factory technical assistance is available through our Application Engineering department.

Stock Allowance and Coolant | Imperial (inch)

Monobloc Style

ISO	Material	Hardness (BHN)	Coolant	Recommended Stock (inch) by Reamer Diameter*		
				.2283 - .3940	.3941 - .7090	.7091 - 1.2638
P	Free Machining Steel 1118, 1215, 12L14, etc.	100 - 180	Water Soluble Cutting Oil	.006 - .012	.008 - .016	.010 - .020
		180 - 250				
	Low Carbon Steel 1010, 1020, 1025, 1522, 1144, etc.	85 - 180				
		180 - 275				
	Medium Carbon Steel 1030, 1040, 1050, 1527, 1140, 1151, etc.	125 - 180				
		180 - 325				
	Alloy Steel 4140, 5140, 8640, etc.	125 - 180				
		180 - 375				
	High Strength Alloy 4340, 4330V, 300M, etc.	240 - 450				
	Structural Steel A36, A285, A516	125 - 180				
		180 - 350				
	Tool Steel H-13, H-21, A-4, O-2, S-3, etc.	150 - 200				
		200 - 250				
S	High Temp Alloy Hastelloy B, Inconel 600, etc.	140 - 310	Water Soluble Cutting Oil	.008 - .016	.012 - .016	.012 - .020
	Titanium Alloy	140 - 310				
M	Stainless Steel 400 Series 416, 420, etc.	135 - 350	Water Soluble Cutting Oil	.006 - .012	.008 - .016	.010 - .020
	Stainless Steel 300 Series 304, 316, 17-4PH, etc.	135 - 275				
K	Grey Cast Iron, Ductile Cast Iron, Spheroidal Cast Iron (Pearlitic)	< 200	Water Soluble Cutting Oil	.006 - .012	.008 - .016	.010 - .020
	Spheroidal Cast Iron (Ferritic)	> 200				
		260 - 320				
N	Copper and Alloys	< 500	Water Soluble	.006 - .012	.008 - .016	.010 - .020
	Brass					
	Bronze	< 180	Water Soluble Cutting Oil			
	Bronze Phosphorous					
	Aluminum and Alloys	< 150	Water Soluble Cutting Oil			

*Stock value is on diameter.

A
DRILLING
B
BORING
C
REAMING
D
URNISHING
E
HREADING
X
PECIALS

Recommended Cutting Data | Imperial (inch)

Cutting Ring Style

ISO	Material	Hardness (BHN)	Speed (SFM)			Recommended Feed (IPR) by Reamer Diameter					
			Uncoated Carbide	Coated Carbide	Cermet	.6929 - 1.5750		1.5751 - 3.1500		3.1501 - 7.8972	
						Lead A, G	Lead E, N, M	Lead A, G	Lead E, N, M	Lead A, G	Lead E, N, M
P	Free Machining Steel 1118, 1215, 12L14, etc.	100 - 180	25 - 50	200 - 260	300 - 980	.020 - .031	.024 - .047	.020 - .039	.031 - .063	.031 - .059	.039 - .087
		180 - 250	20 - 35	130 - 230	260 - 660	.016 - .028	.016 - .039	.020 - .031	.024 - .055	.031 - .047	.039 - .079
	Low Carbon Steel 1010, 1020, 1025, 1522, 1144, etc.	85 - 180	25 - 50	200 - 260	300 - 980	.020 - .031	.024 - .047	.020 - .039	.031 - .063	.031 - .059	.039 - .087
		180 - 275	20 - 35	130 - 230	260 - 660	.016 - .028	.016 - .039	.020 - .031	.024 - .055	.031 - .047	.039 - .079
	Medium Carbon Steel 1030, 1040, 1050, 1527, 1140, 1151, etc.	125 - 180	25 - 50	200 - 260	300 - 980	.020 - .031	.024 - .047	.020 - .039	.031 - .063	.031 - .059	.039 - .087
		180 - 325	20 - 35	130 - 230	260 - 660	.016 - .028	.016 - .039	.020 - .031	.024 - .055	.031 - .047	.039 - .079
	Alloy Steel 4140, 5140, 8640, etc.	125 - 180	20 - 35	130 - 230	260 - 660	.020 - .031	.024 - .047	.020 - .039	.031 - .063	.031 - .059	.039 - .087
		180 - 375	15 - 25	100 - 160	200 - 490	.016 - .028	.016 - .039	.020 - .031	.024 - .055	.031 - .047	.039 - .079
	High Strength Alloy 4340, 4330V, 300M, etc.	240 - 450	10 - 20	50 - 100	200 - 390	.012 - .024	.016 - .031	.016 - .031	.020 - .039	.024 - .039	.028 - .055
S	High Temp Alloy Hastelloy B, Inconel 600, etc.	140 - 310	15 - 25	60 - 200	-	.012 - .020	-	.016 - .024	-	.020 - .028	-
	Titanium Alloy	140 - 310	15 - 25	60 - 200	-	.012 - .020	-	.016 - .024	-	.020 - .028	-
M	Stainless Steel 400 Series 416, 420, etc.	135 - 350	15 - 25	100 - 160	200 - 490	.016 - .028	.016 - .039	.020 - .031	.024 - .055	.031 - .047	.039 - .079
	Stainless Steel 300 Series 304, 316, 17-4PH, etc.	135 - 275	15 - 25	100 - 160	200 - 490	.016 - .028	.016 - .039	.020 - .031	.024 - .055	.031 - .047	.039 - .079
K	Grey Cast Iron, Ductile Cast Iron,	< 200	50 - 100	160 - 230	-	.016 - .039	.024 - .059	.024 - .051	.031 - .063	.031 - .067	.039 - .088
	Spheroidal Cast Iron (Pearlitic)	> 200	35 - 65	160 - 230	-	.016 - .039	.024 - .059	.024 - .051	.031 - .063	.031 - .067	.039 - .088
	Spheroidal Cast Iron (Ferritic)	260 - 320	25 - 40	100 - 160	200 - 400	.016 - .039	.024 - .059	.024 - .051	.031 - .063	.031 - .067	.039 - .088
N	Copper and Alloys	< 500	35 - 60	330 - 660	-	.020 - .031	-	.024 - .039	-	.031 - .055	-
	Brass										
	Bronze	< 180	35 - 65	260 - 520	330 - 980	.012 - .024	-	.016 - .031	-	.024 - .039	-
	Bronze Phosphorous										
	Aluminum and Alloys	< 150	50 - 100	330 - 660	-	.020 - .031	-	.024 - .039	-	.031 - .055	-

Formulas

<p>1. RPM = (SFM • 3.82) / DIA</p> <p>where:</p> <p>RPM = revolutions per minute (rev/min)</p> <p>SFM = speed (ft/min)</p> <p>DIA = diameter of reamer (inch)</p>	<p>2. IPM = RPM • IPR</p> <p>where:</p> <p>IPM = inches per minute (in/min)</p> <p>RPM = revolutions per minute (rev/min)</p> <p>IPR = feed rate (in/rev)</p>	<p>3. SFM = RPM • 0.262 • DIA</p> <p>where:</p> <p>SFM = speed (ft/min)</p> <p>RPM = revolutions per minute (rev/min)</p> <p>DIA = diameter of reamer (inch)</p>
--	--	---

IMPORTANT: The speeds and feeds listed on these pages are a general starting point for all applications. Factory technical assistance is available through our Application Engineering department.

Stock Allowance and Coolant | Imperial (inch)

Cutting Ring Style

ISO	Material	Hardness (BHN)	Coolant	Recommended Stock (inch) by Reamer Diameter*		
				.6929 - 1.5750	1.5751 - 3.1500	3.1501 - 7.8972
P	Free Machining Steel 1118, 1215, 12L14, etc.	100 - 180	Water Soluble Cutting Oil	.006 - .012	.008 - .016	.010 - .020
		180 - 250				
	Low Carbon Steel 1010, 1020, 1025, 1522, 1144, etc.	85 - 180				
		180 - 275				
	Medium Carbon Steel 1030, 1040, 1050, 1527, 1140, 1151, etc.	125 - 180				
		180 - 325				
	Alloy Steel 4140, 5140, 8640, etc.	125 - 180				
		180 - 375				
	High Strength Alloy 4340, 4330V, 300M, etc.	240 - 450				
	Structural Steel A36, A285, A516	125 - 180				
		180 - 350				
	Tool Steel H-13, H-21, A-4, O-2, S-3, etc.	150 - 200				
		200 - 250				
S	High Temp Alloy Hastelloy B, Inconel 600, etc.	140 - 310	Water Soluble Cutting Oil	.008 - .016	.012 - .016	.012 - .020
	Titanium Alloy	140 - 310				
M	Stainless Steel 400 Series 416, 420, etc.	135 - 350	Water Soluble Cutting Oil	.006 - .012	.008 - .016	.010 - .020
	Stainless Steel 300 Series 304, 316, 17-4PH, etc.	135 - 275				
K	Grey Cast Iron, Ductile Cast Iron, Spheroidal Cast Iron (Pearlitic)	< 200	Water Soluble Cutting Oil	.006 - .012	.008 - .016	.010 - .020
	Spheroidal Cast Iron (Pearlitic)	> 200				
	Spheroidal Cast Iron (Ferritic)	260 - 320				
N	Copper and Alloys	< 500	Water Soluble	.006 - .012	.008 - .016	.010 - .020
	Brass					
	Bronze	< 180	Water Soluble Cutting Oil			
	Bronze Phosphorous					
	Aluminum and Alloys	< 150	Water Soluble Cutting Oil			

*Stock value is on diameter.

A
DRILLING
B
BORING
C
REAMING
D
URNISHING
E
HREADING
X
PECIALS

Recommended Cutting Data | Metric (mm)

Replaceable Head Style

ISO	Material	Hardness (BHN)	Speed (M/min)			Recommended Feed (mm/rev) by Reamer Diameter					
			Uncoated Carbide	Coated Carbide	Cermet	11.80 - 21.60		21.61 - 39.60		39.61 - 60.60	
						Lead A, G	Lead E, N, M	Lead A, G	Lead E, N, M	Lead A, G	Lead E, N, M
P	Free Machining Steel 1118, 1215, 12L14, etc.	100 - 180	10 - 20	60 - 80	90 - 300	.25 - .60	.50 - .60	.30 - .80	.60 - 1.20	.60 - 1.00	.70 - 1.50
		180 - 250	7 - 15	40 - 70	80 - 200	.30 - .60	.40 - .80	.40 - .80	.50 - 1.00	.50 - .90	.60 - 1.20
	Low Carbon Steel 1010, 1020, 1025, 1522, 1144, etc.	85 - 180	10 - 20	60 - 80	90 - 300	.25 - .60	.50 - .60	.30 - .80	.60 - 1.20	.60 - 1.00	.70 - 1.50
		180 - 275	7 - 15	40 - 70	80 - 200	.30 - .60	.40 - .80	.40 - .80	.50 - 1.00	.50 - .90	.60 - 1.20
	Medium Carbon Steel 1030, 1040, 1050, 1527, 1140, 1151, etc.	125 - 180	10 - 20	60 - 80	90 - 300	.25 - .60	.50 - .60	.30 - .80	.60 - 1.20	.60 - 1.00	.70 - 1.50
		180 - 325	7 - 15	40 - 70	80 - 200	.30 - .60	.40 - .80	.40 - .80	.50 - 1.00	.50 - .90	.60 - 1.20
	Alloy Steel 4140, 5140, 8640, etc.	125 - 180	6 - 10	40 - 70	80 - 200	.25 - .60	.50 - .60	.30 - .80	.60 - 1.20	.60 - 1.00	.70 - 1.50
		180 - 375	4 - 8	30 - 50	60 - 150	.30 - .60	.40 - .80	.40 - .80	.50 - 1.00	.50 - .90	.60 - 1.20
	High Strength Alloy 4340, 4330V, 300M, etc.	240 - 450	3 - 6	15 - 30	60 - 120	.25 - .50	.30 - .60	.30 - .60	.40 - .80	.40 - .70	.50 - 1.00
S	High Temp Alloy Hastelloy B, Inconel 600, etc.	140 - 310	4 - 10	30 - 50	—	.20 - .40	—	.30 - .50	—	.40 - .60	—
	Titanium Alloy	140 - 310	4 - 15	30 - 50	—	.20 - .40	—	.30 - .50	—	.40 - .60	—
M	Stainless Steel 400 Series 416, 420, etc.	135 - 350	4 - 10	30 - 50	60 - 150	.30 - .60	.40 - .80	.40 - .80	.50 - 1.00	.50 - .90	.60 - 1.20
	Stainless Steel 300 Series 304, 316, 17-4PH, etc.	135 - 275	4 - 10	30 - 50	60 - 150	.30 - .60	.40 - .80	.40 - .80	.50 - 1.00	.50 - .90	.60 - 1.20
K	Grey Cast Iron, Ductile Cast Iron,	< 200	20 - 40	50 - 70	—	.20 - .60	.50 - 1.00	.30 - .70	.60 - 1.20	.60 - 1.30	.80 - 1.60
	Spheroidal Cast Iron (Pearlitic)	> 200	15 - 30	50 - 70	—	.20 - .60	.50 - 1.00	.30 - .70	.60 - 1.20	.60 - 1.30	.80 - 1.60
	Spheroidal Cast Iron (Ferritic)	260 - 320	10 - 15	30 - 50	60 - 120	.20 - .60	.50 - .60	.30 - .70	.60 - 1.20	.40 - .80	.80 - 1.60
N	Copper and Alloys	< 500	60 - 200	100 - 200	—	.20 - .60	—	.30 - .70	—	.40 - .80	—
	Brass										
	Bronze	< 180	20 - 40	80 - 160	100 - 300	.30 - .60	.40 - 1.00	.30 - .60	.50 - 1.20	.30 - .60	.60 - 1.50
	Bronze Phosphorous										
	Aluminum and Alloys	< 150	20 - 200	—	—	.30 - .60	—	.40 - 1.00	—	.40 - 1.00	—

Formulas

<p>1. $RPM = M/min \cdot 3.82 \cdot DIA$</p> <p>where:</p> <ul style="list-style-type: none"> RPM = revolutions per minute (rev/min) M/min = speed (M/min) DIA = diameter of reamer (mm) 	<p>2. $mm/min = RPM \cdot mm/rev$</p> <p>where:</p> <ul style="list-style-type: none"> mm/min = mm per minute (mm/min) RPM = revolutions per minute (rev/min) mm/rev = feed rate (mm/rev) 	<p>3. $M/min = RPM \cdot 0.003 \cdot DIA$</p> <p>where:</p> <ul style="list-style-type: none"> M/min = speed (M/min) RPM = revolutions per minute (rev/min) DIA = diameter of reamer (mm)
--	---	---

IMPORTANT: The speeds and feeds listed on these pages are a general starting point for all applications. Factory technical assistance is available through our Application Engineering department.

Stock Allowance and Coolant | Metric (mm)

Replaceable Head Style

ISO	Material	Hardness (BHN)	Coolant	Recommended Stock (mm) by Reamer Diameter*		
				11.80 - 21.60	21.61 - 39.60	39.61 - 60.60
P	Free Machining Steel 1118, 1215, 12L14, etc.	100 - 180	Water Soluble Cutting Oil	0.15 - 0.25	0.20 - 0.40	0.30 - 0.40
		180 - 250				
	Low Carbon Steel 1010, 1020, 1025, 1522, 1144, etc.	85 - 180				
		180 - 275				
	Medium Carbon Steel 1030, 1040, 1050, 1527, 1140, 1151, etc.	125 - 180				
		180 - 325				
	Alloy Steel 4140, 5140, 8640, etc.	125 - 180				
		180 - 375				
	High Strength Alloy 4340, 4330V, 300M, etc.	240 - 450				
S	High Temp Alloy Hastelloy B, Inconel 600, etc.	140 - 310	Water Soluble Cutting Oil	0.15 - 0.25	0.20 - 0.40	0.30 - 0.40
		140 - 310				
	Titanium Alloy	140 - 310				
M	Stainless Steel 400 Series 416, 420, etc.	135 - 350	Water Soluble Cutting Oil	0.15 - 0.25	0.20 - 0.40	0.30 - 0.40
	Stainless Steel 300 Series 304, 316, 17-4PH, etc.	135 - 275				
K	Grey Cast Iron, Ductile Cast Iron, Spheroidal Cast Iron (Pearlitic)	< 200	Water Soluble Cutting Oil	0.15 - 0.25	0.20 - 0.40	0.30 - 0.40
		> 200				
	Spheroidal Cast Iron (Ferritic)	260 - 320				
N	Copper and Alloys	< 500	Water Soluble	0.15 - 0.25	0.20 - 0.40	0.30 - 0.40
	Brass					
	Bronze	< 180	Water Soluble Cutting Oil			
	Bronze Phosphorous					
	Aluminum and Alloys	< 150	Water Soluble Cutting Oil			

*Stock value is on diameter.

A
DRILLING
B
BORING
C
REAMING
D
URNISHING
E
HREADING
X
PECIALS

Recommended Cutting Data | Metric (mm)

Monobloc Style

ISO	Material	Hardness (BHN)	Speed (M/min)			Recommended Feed (mm/rev) by Reamer Diameter					
			Uncoated Carbide	Coated Carbide	Cermet	5.80 - 10.00		10.01 - 22.00		22.01 - 32.10	
						Lead A, G	Lead E, N, M	Lead A, G	Lead E, N, M	Lead A, G	Lead E, N, M
P	Free Machining Steel 1118, 1215, 12L14, etc.	100 - 180	7 - 15	60 - 80	90 - 300	.20 - .40	.30 - .60	.40 - .60	.40 - 1.00	.50 - .80	.60 - 1.20
		180 - 250	6 - 10	40 - 70	80 - 200	.20 - .40	.30 - .50	.30 - .60	.30 - .80	.40 - .70	.40 - 1.00
	Low Carbon Steel 1010, 1020, 1025, 1522, 1144, etc.	85 - 180	7 - 15	60 - 80	90 - 300	.20 - .40	.30 - .60	.40 - .60	.40 - 1.00	.50 - .80	.60 - 1.20
		180 - 275	6 - 10	40 - 70	80 - 200	.20 - .40	.30 - .50	.30 - .60	.30 - .80	.40 - .70	.40 - 1.00
	Medium Carbon Steel 1030, 1040, 1050, 1527, 1140, 1151, etc.	125 - 180	7 - 15	60 - 80	90 - 300	.20 - .40	.30 - .60	.40 - .60	.40 - 1.00	.50 - .80	.60 - 1.20
		180 - 325	6 - 10	40 - 70	80 - 200	.20 - .40	.30 - .50	.30 - .60	.30 - .80	.40 - .70	.40 - 1.00
	Alloy Steel 4140, 5140, 8640, etc.	125 - 180	6 - 10	40 - 70	80 - 200	.20 - .40	.30 - .60	.40 - .60	.40 - 1.00	.50 - .80	.60 - 1.20
		180 - 375	4 - 8	30 - 50	60 - 150	.20 - .40	.30 - .50	.30 - .60	.30 - .80	.40 - .70	.40 - 1.00
	High Strength Alloy 4340, 4330V, 300M, etc.	240 - 450	3 - 6	15 - 30	60 - 120	.15 - .30	.20 - .40	.20 - .50	.30 - .60	.30 - .60	.40 - .80
S	High Temp Alloy Hastelloy B, Inconel 600, etc.	140 - 310	4 - 10	30 - 50	—	.15 - .30	—	.20 - .40	—	.30 - .50	—
	Titanium Alloy	140 - 310	4 - 15	30 - 50	—	.15 - .30	—	.20 - .40	—	.30 - .50	—
M	Stainless Steel 400 Series 416, 420, etc.	135 - 350	4 - 10	30 - 50	60 - 150	.20 - .40	.30 - .50	.30 - .60	.30 - .80	.40 - .70	.40 - 1.00
	Stainless Steel 300 Series 304, 316, 17-4PH, etc.	135 - 275	4 - 10	30 - 50	60 - 150	.20 - .40	.30 - .50	.30 - .60	.30 - .80	.40 - .70	.40 - 1.00
K	Grey Cast Iron, Ductile Cast Iron,	< 200	15 - 30	50 - 70	—	.20 - .40	.30 - .60	.35 - .60	.50 - .80	.40 - 1.00	.60 - 1.50
	Spheroidal Cast Iron (Pearlitic)	> 200	10 - 20	50 - 70	—	.20 - .40	.30 - .60	.35 - .60	.50 - .80	.40 - 1.00	.60 - 1.50
	Spheroidal Cast Iron (Ferritic)	260 - 320	8 - 12	30 - 50	60 - 120	.20 - .40	.30 - .60	.35 - .60	.50 - .80	.40 - 1.00	.60 - 1.50
N	Copper and Alloys	< 500	10 - 18	100 - 200	—	.20 - .40	—	.40 - .70	—	.50 - .80	—
	Brass										
	Bronze	< 180	10 - 20	80 - 160	100 - 300	.15 - .30	—	.20 - .40	—	.30 - .60	—
	Bronze Phosphorous										
	Aluminum and Alloys	< 150	15 - 30	100 - 200	—	.20 - .40	—	.40 - .70	—	.50 - .80	—

Formulas

<p>1. $RPM = M/min \cdot 3.82 \cdot DIA$</p> <p>where:</p> <p>RPM = revolutions per minute (rev/min)</p> <p>M/min = speed (M/min)</p> <p>DIA = diameter of reamer (mm)</p>	<p>2. $mm/min = RPM \cdot mm/rev$</p> <p>where:</p> <p>mm/min = mm per minute (mm/min)</p> <p>RPM = revolutions per minute (rev/min)</p> <p>mm/rev = feed rate (mm/rev)</p>	<p>3. $M/min = RPM \cdot 0.003 \cdot DIA$</p> <p>where:</p> <p>M/min = speed (M/min)</p> <p>RPM = revolutions per minute (rev/min)</p> <p>DIA = diameter of reamer (mm)</p>
---	--	--

IMPORTANT: The speeds and feeds listed on these pages are a general starting point for all applications. Factory technical assistance is available through our Application Engineering department.

Stock Allowance and Coolant | Metric (mm)

Monobloc Style

ISO	Material	Hardness (BHN)	Coolant	Recommended Stock (mm) by Reamer Diameter*		
				5.80 - 10.00	10.01 - 22.00	22.01 - 32.10
P	Free Machining Steel 1118, 1215, 12L14, etc.	100 - 180	Water Soluble Cutting Oil	0.08 - 0.15	0.15 - 0.25	0.15 - 0.30
		180 - 250				
	Low Carbon Steel 1010, 1020, 1025, 1522, 1144, etc.	85 - 180				
		180 - 275				
	Medium Carbon Steel 1030, 1040, 1050, 1527, 1140, 1151, etc.	125 - 180				
		180 - 325				
	Alloy Steel 4140, 5140, 8640, etc.	125 - 180				
		180 - 375				
	High Strength Alloy 4340, 4330V, 300M, etc.	240 - 450				
S	High Temp Alloy Hastelloy B, Inconel 600, etc.	140 - 310	Water Soluble Cutting Oil	0.10 - 0.20	0.15 - 0.25	0.20 - 0.40
		140 - 310				
	Titanium Alloy	140 - 310				
M	Stainless Steel 400 Series 416, 420, etc.	135 - 350	Water Soluble Cutting Oil	0.08 - 0.15	0.15 - 0.25	0.15 - 0.30
	Stainless Steel 300 Series 304, 316, 17-4PH, etc.	135 - 275				
K	Grey Cast Iron, Ductile Cast Iron, Spheroidal Cast Iron (Pearlitic)	< 200	Water Soluble Cutting Oil	0.08 - 0.15	0.15 - 0.25	0.15 - 0.30
		> 200				
	Spheroidal Cast Iron (Ferritic)	260 - 320				
N	Copper and Alloys	< 500	Water Soluble	0.08 - 0.15	0.15 - 0.25	0.15 - 0.30
	Brass					
	Bronze	< 180	Water Soluble Cutting Oil			
	Bronze Phosphorous					
	Aluminum and Alloys	< 150	Water Soluble Cutting Oil			

*Stock value is on diameter.

A

DRILLING

B

BORING

C

REAMING

D

BURNISHING

E

THREADING

X

SPECIALS

Recommended Cutting Data | Metric (mm)

Cutting Ring Style

ISO	Material	Hardness (BHN)	Speed (M/min)			Recommended Feed (mm/rev) by Reamer Diameter					
			Uncoated Carbide	Coated Carbide	Cermet	17.60 - 40.00		40.01 - 80.00		80.01 - 200.00	
						Lead A, G	Lead E, N, M	Lead A, G	Lead E, N, M	Lead A, G	Lead E, N, M
P	Free Machining Steel 1118, 1215, 12L14, etc.	100 - 180	7 - 15	60 - 80	90 - 300	.50 - .80	.60 - 1.20	.50 - 1.00	.80 - 1.60	.80 - 1.50	1.00 - 2.20
		180 - 250	6 - 10	40 - 70	80 - 200	.40 - .70	.40 - 1.00	.50 - .80	.60 - 1.40	.80 - 1.20	1.00 - 2.00
	Low Carbon Steel 1010, 1020, 1025, 1522, 1144, etc.	85 - 180	7 - 15	60 - 80	90 - 300	.50 - .80	.60 - 1.20	.50 - 1.00	.80 - 1.60	.80 - 1.50	1.00 - 2.20
		180 - 275	6 - 10	40 - 70	80 - 200	.40 - .70	.40 - 1.00	.50 - .80	.60 - 1.40	.80 - 1.20	1.00 - 2.00
	Medium Carbon Steel 1030, 1040, 1050, 1527, 1140, 1151, etc.	125 - 180	7 - 15	60 - 80	90 - 300	.50 - .80	.60 - 1.20	.50 - 1.00	.80 - 1.60	.80 - 1.50	1.00 - 2.20
		180 - 325	6 - 10	40 - 70	80 - 200	.40 - .70	.40 - 1.00	.50 - .80	.60 - 1.40	.80 - 1.20	1.00 - 2.00
	Alloy Steel 4140, 5140, 8640, etc.	125 - 180	6 - 10	40 - 70	80 - 200	.50 - .80	.60 - 1.20	.50 - 1.00	.80 - 1.60	.80 - 1.50	1.00 - 2.20
		180 - 375	4 - 8	30 - 50	60 - 150	.40 - .70	.40 - 1.00	.50 - .80	.60 - 1.40	.80 - 1.20	1.00 - 2.00
	High Strength Alloy 4340, 4330V, 300M, etc.	240 - 450	3 - 6	15 - 30	60 - 120	.30 - .60	.40 - .80	.40 - .80	.50 - 1.00	.60 - 1.00	.70 - 1.40
S	High Temp Alloy Hastelloy B, Inconel 600, etc.	140 - 310	4 - 8	30 - 50	—	.30 - .50	—	.40 - .60	—	.50 - .70	—
	Titanium Alloy	140 - 310	4 - 8	30 - 50	—	.30 - .50	—	.40 - .60	—	.50 - .70	—
M	Stainless Steel 400 Series 416, 420, etc.	135 - 350	4 - 8	30 - 50	60 - 150	.40 - .70	.40 - 1.00	.50 - .80	.60 - 1.40	.80 - 1.20	1.00 - 2.00
	Stainless Steel 300 Series 304, 316, 17-4PH, etc.	135 - 275	4 - 8	30 - 50	60 - 150	.40 - .70	.40 - 1.00	.50 - .80	.60 - 1.40	.80 - 1.20	1.00 - 2.00
K	Grey Cast Iron, Ductile Cast Iron,	< 200	15 - 30	50 - 70	—	.40 - 1.00	.60 - 1.50	.60 - 1.30	.80 - 1.60	.80 - 1.70	1.00 - 2.25
	Spheroidal Cast Iron (Pearlitic)	> 200	10 - 20	50 - 70	—	.40 - 1.00	.60 - 1.50	.60 - 1.30	.80 - 1.60	.80 - 1.70	1.00 - 2.25
	Spheroidal Cast Iron (Ferritic)	260 - 320	8 - 12	30 - 50	60 - 120	.40 - 1.00	.60 - 1.50	.60 - 1.30	.80 - 1.60	.80 - 1.70	1.00 - 2.25
N	Copper and Alloys	< 500	10 - 18	100 - 200	—	.50 - .80	—	.60 - 1.00	—	.80 - 1.40	—
	Brass										
	Bronze	< 180	10 - 20	80 - 160	100 - 300	.30 - .60	—	.40 - .80	—	.60 - 1.00	—
	Bronze Phosphorous										
	Aluminum and Alloys	< 150	15 - 30	100 - 200	—	.50 - .80	—	.60 - 1.00	—	.80 - 1.40	—

Formulas

<p>1. $RPM = M/min \cdot 3.82 \cdot DIA$</p> <p>where:</p> <p>RPM = revolutions per minute (rev/min)</p> <p>M/min = speed (M/min)</p> <p>DIA = diameter of reamer (mm)</p>	<p>2. $mm/min = RPM \cdot mm/rev$</p> <p>where:</p> <p>mm/min = mm per minute (mm/min)</p> <p>RPM = revolutions per minute (rev/min)</p> <p>mm/rev = feed rate (mm/rev)</p>	<p>3. $M/min = RPM \cdot 0.003 \cdot DIA$</p> <p>where:</p> <p>M/min = speed (M/min)</p> <p>RPM = revolutions per minute (rev/min)</p> <p>DIA = diameter of reamer (mm)</p>
---	--	--

IMPORTANT: The speeds and feeds listed on these pages are a general starting point for all applications. Factory technical assistance is available through our Application Engineering department.

Stock Allowance and Coolant | Metric (mm)

Cutting Ring Style

ISO	Material	Hardness (BHN)	Coolant	Recommended Stock (mm) by Reamer Diameter*		
				17.60 - 40.00	40.01 - 80.00	80.01 - 200.00
P	Free Machining Steel 1118, 1215, 12L14, etc.	100 - 180	Water Soluble Cutting Oil	0.15 - 0.30	0.20 - 0.40	0.25 - 0.50
		180 - 250				
	Low Carbon Steel 1010, 1020, 1025, 1522, 1144, etc.	85 - 180				
		180 - 275				
	Medium Carbon Steel 1030, 1040, 1050, 1527, 1140, 1151, etc.	125 - 180				
		180 - 325				
	Alloy Steel 4140, 5140, 8640, etc.	125 - 180				
		180 - 375				
	High Strength Alloy 4340, 4330V, 300M, etc.	240 - 450				
S	High Temp Alloy Hastelloy B, Inconel 600, etc.	140 - 310	Water Soluble Cutting Oil	0.20 - 0.40	0.30 - 0.40	0.30 - 0.50
		140 - 310				
	Titanium Alloy	140 - 310				
M	Stainless Steel 400 Series 416, 420, etc.	135 - 350	Water Soluble Cutting Oil	0.15 - 0.30	0.20 - 0.40	0.25 - 0.50
	Stainless Steel 300 Series 304, 316, 17-4PH, etc.	135 - 275				
K	Grey Cast Iron, Ductile Cast Iron,	< 200	Water Soluble Cutting Oil	0.15 - 0.30	0.20 - 0.40	0.25 - 0.50
	Spheroidal Cast Iron (Pearlitic)	> 200				
	Spheroidal Cast Iron (Ferritic)	260 - 320				
N	Copper and Alloys	< 500	Water Soluble	0.15 - 0.30	0.20 - 0.40	0.25 - 0.50
	Brass					
	Bronze	< 180	Water Soluble Cutting Oil			
	Bronze Phosphorous					
	Aluminum and Alloys	< 150	Water Soluble Cutting Oil			

*Stock value is on diameter.

A
DRILLING
B
BORING
C
REAMING
D
URNISHING
E
HREADING
X
PECIALS

Set-up Information

Replaceable Head Style

A
DRILLING
B
BORING
C
REAMING
D
URNISHING
E
HREADING
X
PECIALS

Fixed Head Style

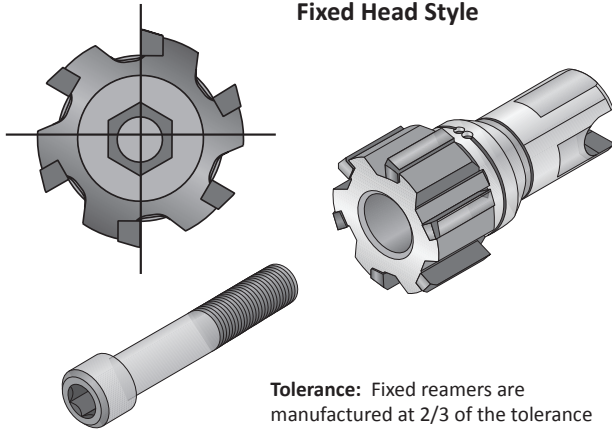

Tolerance: Fixed reamers are manufactured at 2/3 of the tolerance

Recommended Tightening Torque for Fixed Head Reamer (7400 / 7700)

Imperial		Metric	
D ₁ Range (inch)	Torque (in-lbs)	D ₁ Range (mm)	Torque (N-m)
0.465 - 0.575	22.1	11.80 - 14.60	2.5
0.575 - 0.693	33.6	14.61 - 17.60	3.5
0.693 - 0.850	44.3	17.61 - 21.60	5.0
0.851 - 1.047	62.0	21.61 - 26.60	7.0
1.048 - 1.283	88.5	26.61 - 32.60	10.0
1.284 - 1.598	106.2	32.61 - 40.60	12.0
1.599 - 1.992	141.6	40.61 - 50.60	16.0
1.993 - 2.386	177.0	50.61 - 60.60	20.0

Expandable Head Style

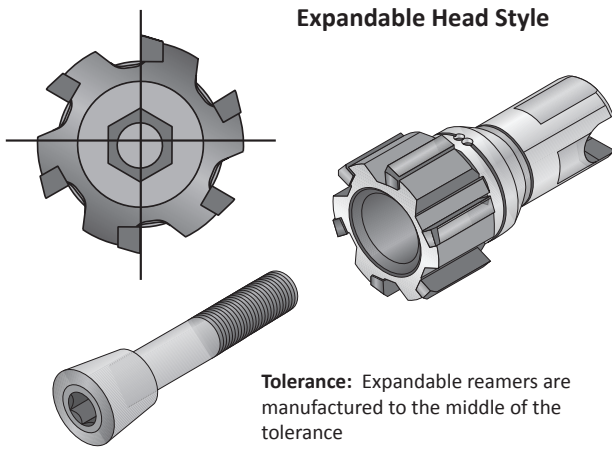

Tolerance: Expandable reamers are manufactured to the middle of the tolerance

Expanding Heads Adjustment

When the size reaches its lower tolerance, the head can be adjusted to compensate for wear to the cutting edges. This operation can be repeated several times until the surface finish of the hole deteriorates to an unacceptable level.

Adjustment Procedure

Slowly turn the right hand threaded screw clockwise while checking the diameter setting of the reamer with a micrometer. When the required diameter is achieved, the tool is ready for use.

Replaceable Head Reamer Assembly

Fixed and Expandable Styles

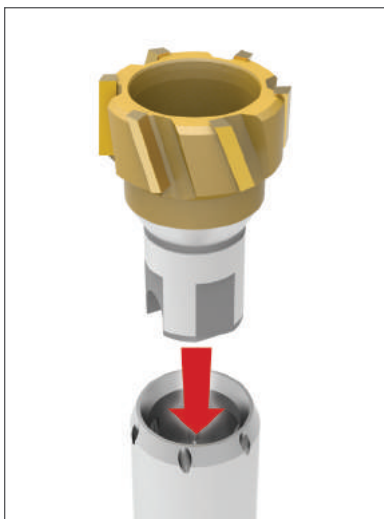

Step 1: Insert the replaceable reamer head into the mandrel.

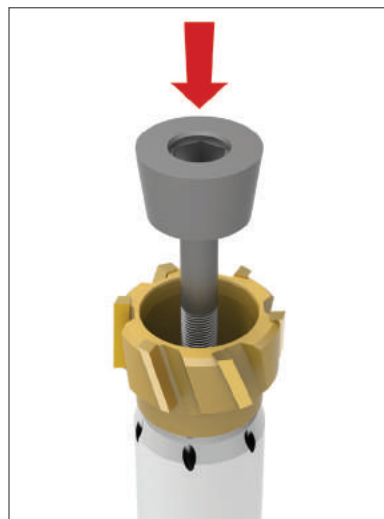

Step 2: Insert the screw into the reamer head opening to secure it to the mandrel.



Step 3: Tighten the screw.

NOTE: We recommend lubricating the thread and the conical surface of contact between the reamer head and the screw with antifriction Molycote grease.

Set-up Information

Monobloc Style

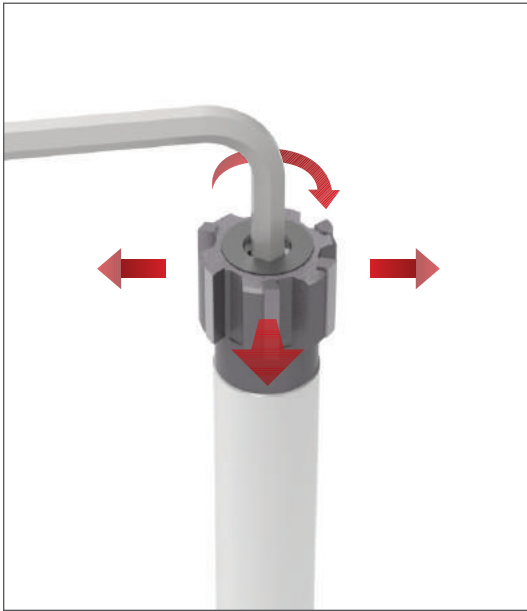

Tolerance

All monobloc reamers are ground to the requested diameter and set in the middle of the hole tolerance, ready for use.

Adjustment

The adjustment must be made to compensate for wear to the cutting edges when the size reaches its lower tolerance. This operation can be repeated several times until the surface finish of the hole deteriorates to an unacceptable level. Then the reamer must be reground. The maximum expansion is about 1% of the diameter.

A

DRILLING

B

BORING

C

REAMING

D

BURNISHING

E

THREADING

X

SPECIALS

Set-up Information

Cutting Ring Style

Drive Pin
(11:00 position)

Dimples
(12:00 position)

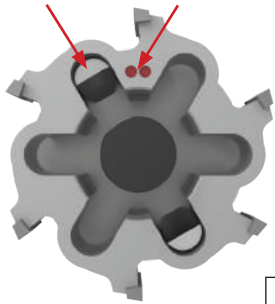

Step 1:
With the drive pins assembled, insert the cutting ring onto the mandrel. Make sure the dimples are at the 12:00 position with the drive pin at the 11:00 position.

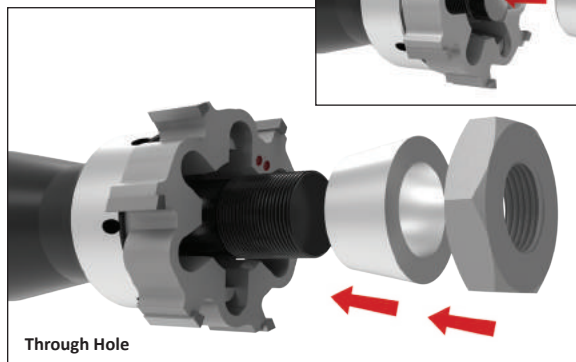
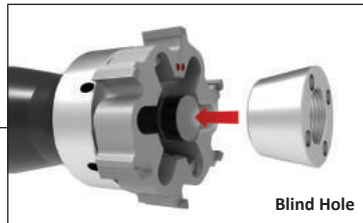

Step 2:

Insert the conical ring. Tighten the lock nut to set the desired reamer size (left hand thread). Then loosen the lock nut slightly until it “clicks” against the drive wall.

NOTE: We recommend lubricating the thread and the conical surface of contact between the cutting ring and the conical ring with antifriction Molycote grease.

For Diameter Range: 100.60mm - 200.59mm

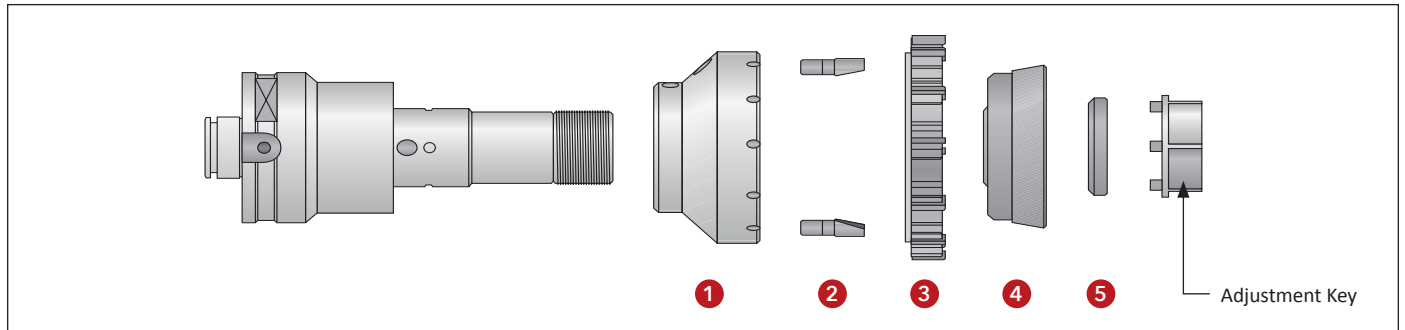

Assembly

1. With the drive pins (2) assembled, mount the flange (1) onto the mandrel. Assemble the cutting ring (3) so the slot on the left side of the dimple is mounted onto the drive pins (2). Insert the conical ring (4).
2. Screw the ring nut (5) onto the mandrel and tighten manually so the conical ring (4) makes contact with the cutting ring (3). The thread is left handed.

NOTE: We recommend lubricating the thread and the conical surface of contact between the cutting ring and the conical ring with antifriction Molycote grease.

Adjustment Procedure

1. Turn the ring nut (5) slowly using a pin spanner.
2. Check the diameter setting of the cutting ring with a micrometer. Make sure the drive pins (2) are in traction and in the opposite direction of the cutting action of the reamer.
3. When the required diameter is achieved, the tool is ready to use.



Adjustment Procedure

1. Turn the conical ring slowly using an adjustment key (left hand thread). Adjustment keys are supplied with reamers from diameter 17.60mm to 40.59mm.
2. Check the diameter setting of the cutting ring with a micrometer.
3. When the required diameter is achieved, unscrew the conical ring until there is a click and the drive pins are in traction in the opposite direction to the cutting action of the reamer. The reamer is ready for use.

A DRILLING

B BORING

C REAMING

D BURNISHING

E THREADING

X SPECIALS

Diameter Measurement

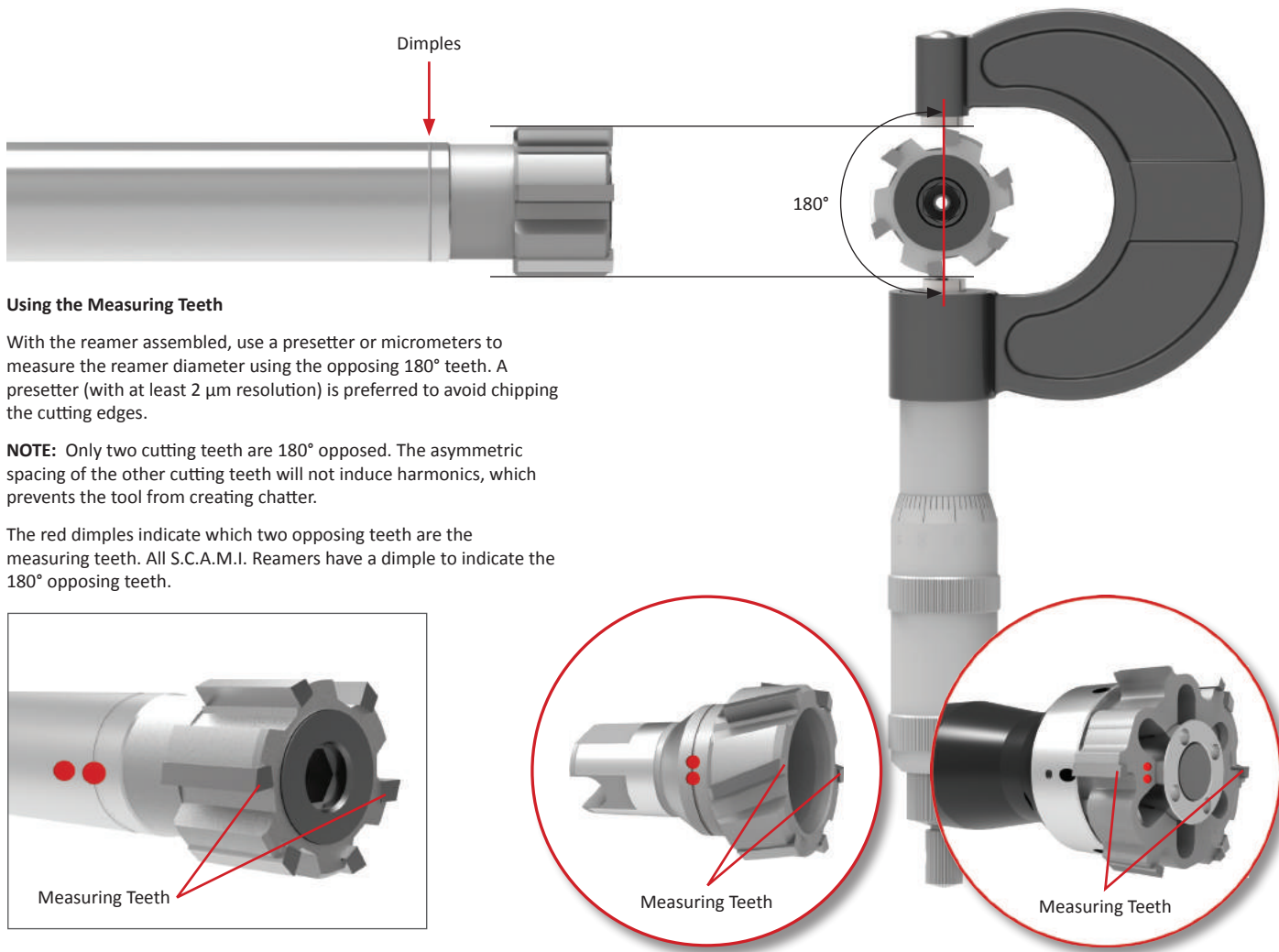

Using the Measuring Teeth

With the reamer assembled, use a presetter or micrometers to measure the reamer diameter using the opposing 180° teeth. A presetter (with at least 2 µm resolution) is preferred to avoid chipping the cutting edges.

NOTE: Only two cutting teeth are 180° opposed. The asymmetric spacing of the other cutting teeth will not induce harmonics, which prevents the tool from creating chatter.

The red dimples indicate which two opposing teeth are the measuring teeth. All S.C.A.M.I. Reamers have a dimple to indicate the 180° opposing teeth.

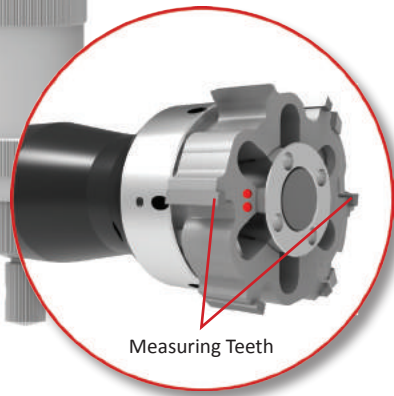
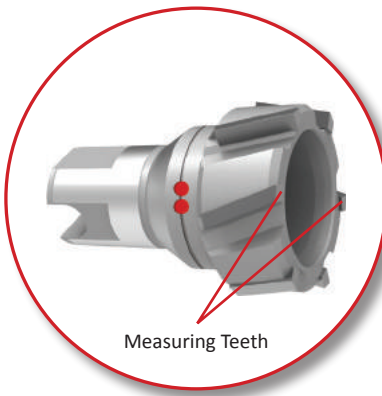
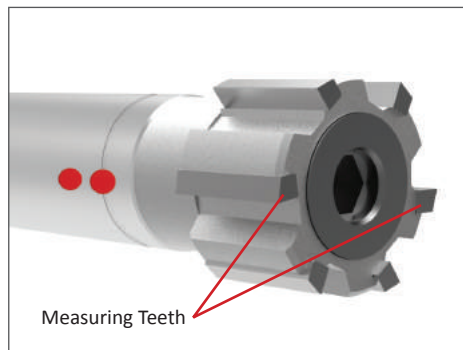

Where to Take the Measurement

When measuring the diameter, take the measurement from the area of the cutting tooth just below the transition from the lead angle to the OD edge. See the illustration below.

The back side of the OD edge has a back taper. This is why measuring from the location just below the lead angle/OD edge transition point results in the most accurate measurement (before the taper begins).

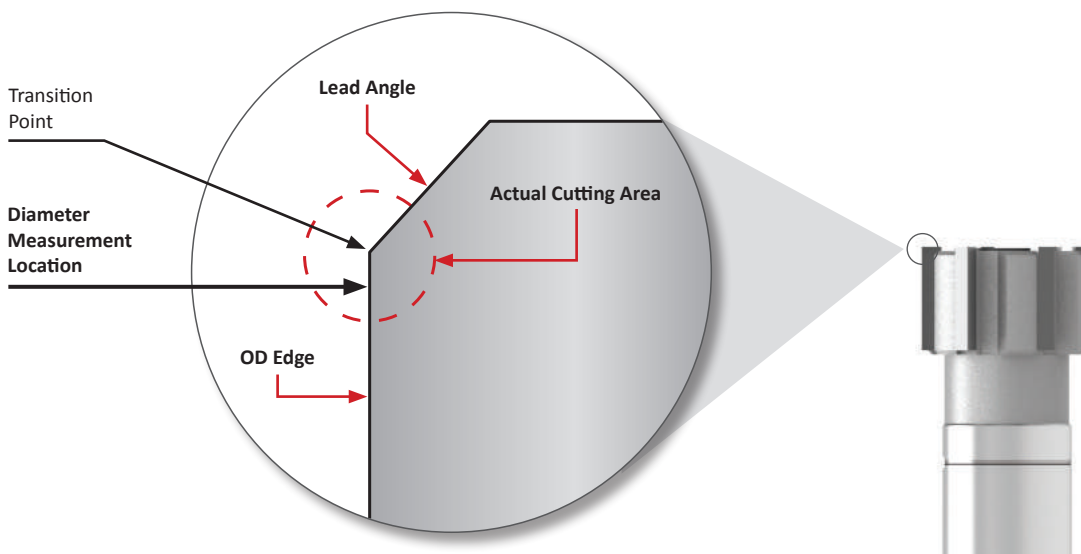

TIR Measurement

What is TIR?

Total indicator runout (TIR) refers to the distance to which the reamer is cutting off-center. In an ideal situation, the tool would begin in the exact center of the hole, and it would then rotate and cut in a perfect circle. This would result in a TIR of 0.

Because a perfect TIR of 0 is not practical, the goal is to maintain a TIR as close to 0 as possible. The closer the TIR is to 0, the better the reamer will perform.

Allied Machine recommends a TIR of $< 0.0005''$ (0.013mm).

Think of attempting to draw a perfect circle with a drafting compass, but the pencil runs slightly outside the point where the circle began because the center point shifted during the pencil's path. This slight area of overlap would be the TIR.

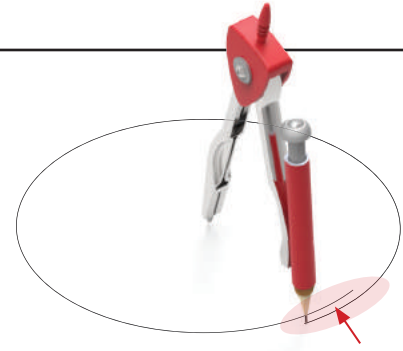

TIR: How far from center the tool will move during its path

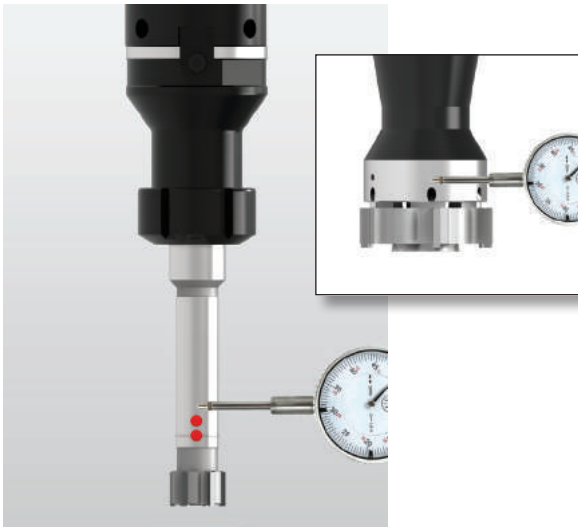

Step 1:

Check the TIR first on the mandrel (or ground) area of the reamer. Center the indicator in line with the dimple.

Measure the TIR by rotating the tool until the indicator reaches the highest value.

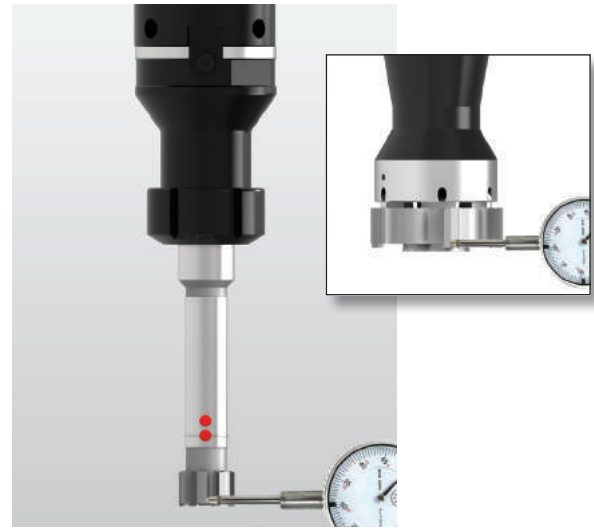

Step 2:

Next, check the TIR on the cutting teeth of the reamer.

NOTE: Rotate the tool counterclockwise to avoid chipping the cutting teeth with the indicator.

TIR Adjustment

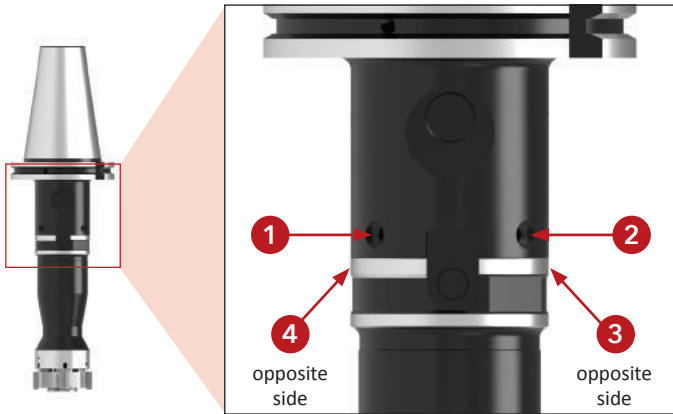

Step 1:

Place the tool into the machine spindle. Make contact with the 4 radial adjustment screws in a concentric fashion (this results in equal pressure surrounding the tool).

Tighten #1, then #3, followed by #2 and #4.



Step 2:

Swipe the dial indicator around the ground portion of the arbor near the coolant outlet holes to verify the TIR.

The TIR should be within 0.0005" (as close to 0 as possible). This will ensure the TIR check on the cutting teeth will be more true. It also means the arbor is running true to the shank.

Step 3:

Once the TIR is checked on the arbor, check the TIR on the cutting teeth. Rotate the tool counterclockwise to avoid chipping the cutting teeth.

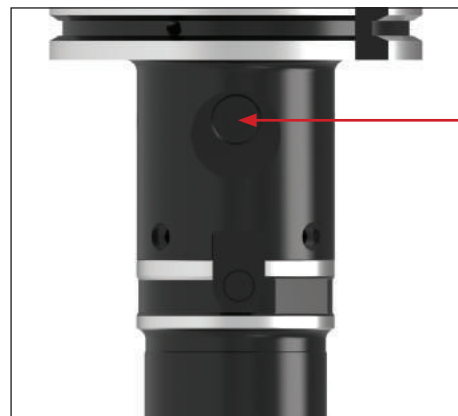
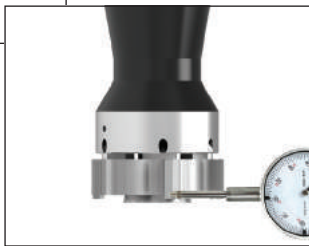

Step 4:

Tighten down the central clamping screws. During the tightening, the tool body will shift slightly. Repeat the TIR check on the cutting teeth, and adjust as necessary.

Troubleshooting Guide

A
DRILLING

B
BORING

C
REAMING

D
BURNISHING

E
THREADING

X
SPECIALS

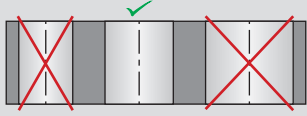

Oversized Hole

- Reamer is running eccentric to the center of the machine spindle ▶ Use modular system with radial adjustment
- Excessive misalignment causing reamer to cut on back taper ▶ Fix the misalignment
- Material build up on cutting edges ▶ Replace the coolant or change the cutting speed
- Reamer diameter is too large ▶ Use smaller reamer or regrind existing reamer

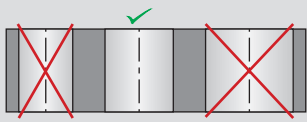

Undersized Hole

- The reamer diameter is too small ▶ Use larger reamer
- The reamer diameter is worn ▶ Expand, regrind, or replace the reamer
- The coolant is not suitable ▶ Replace the coolant
- Stock allowance is too small ▶ Increase the stock allowance
- The cutting speed is too low ▶ Increase the cutting speed

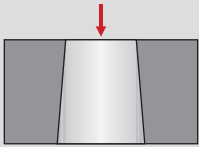

Tapered Hole

- Excessive misalignment ▶ Correct the misalignment

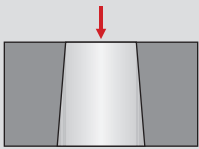

Burr at Hole Entry

- Excessive misalignment ▶ Correct the misalignment

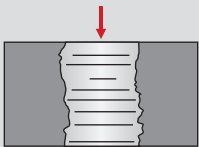

Hole is Not Straight

- Concentricity and alignment error between the workpiece and the tool ▶ Correct the misalignment and use the modular system with radial adjustment
- Asymmetrical cutting or angled surfaces ▶ Create a chamfer on the lead-in

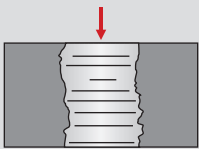

Poor Hole Finish

- One cutting edge is chipped ▶ Regrind the reamer
- The lead-in is irregular ▶ Regrind the reamer
- Back taper on the cutting edge is too great ▶ Regrind the reamer
- Excessive misalignment ▶ Correct the misalignment or use the modular system
- Cutting data is not correct ▶ Verify the cutting data
- Poor chip evacuation ▶ Verify the coolant volume and pressure or use through tool coolant

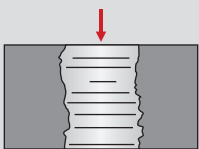

Reamer Creates Excessive Torque Loading

- Back taper on the cutting edge is too small ▶ Regrind the reamer
- The radially ground land is too wide ▶ Regrind the reamer
- The coolant is not suitable ▶ Replace the coolant

This page left intentionally blank

A

DRILLING

B

BORING

C

REAMING

D

BURNISHING

E

THREADING

X

SPECIALS

Roller Burnishing Systems

Through Hole Style | Blind Hole Style



Get the Finish You Need

Allied Machine is proud to offer roller burnishing tools from S.C.A.M.I.®. These hole finishing tools provide extremely high-quality surface finish on both through hole and blind hole applications. With roller burnishing, you can eliminate the need for slower and more costly finishing processes and secondary operations such as grinding, honing, and lapping.

Not only will the roller burnishing tools create a smooth surface finish, but they will also harden the material and increase the wear resistance of the part. The benefits of this single operation result in the hole quality you should expect from Allied Machine.

Creates fine surface finishes	Increases wear and corrosion resistance	Eliminates other processes and saves you money
-------------------------------	---	--

Applicable Industries

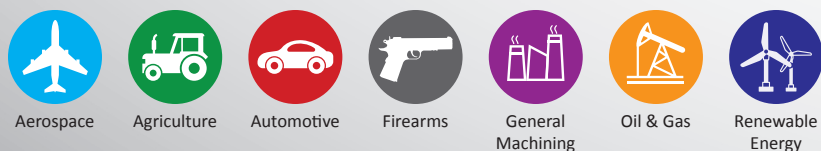

Your safety and the safety of others is very important. This catalog contains important safety messages. Always read and follow all safety precautions.

 This triangle is a safety hazard symbol. It alerts you to potential safety hazards that can cause tool failure and serious injury.

When you see this symbol in the catalog, look for a related safety message that may be near this triangle or referred to in the nearby text.

There are safety signal words also used in the catalog. Safety messages follow these words.

⚠ WARNING

WARNING (shown above) means that failure to follow the precautions in this message could result in tool failure and serious injury.

NOTICE means that failure to follow the precautions in this message could result in damage to the tool or machine but not result in personal injury.

NOTE and **IMPORTANT** are also used. These are important that you read and follow but are not safety-related.

Visit www.alliedmachine.com for the most up-to-date information and procedures.

Reference Icons

The following icons will appear throughout the catalog to help you navigate between products.



Technical Information

Detailed instructions and information regarding the corresponding part(s)

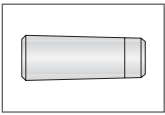

Through Hole Rolls

Refers to the rolls available for through hole burnishing tools

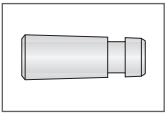

Blind Hole Rolls

Refers to the rolls available for blind hole burnishing tools

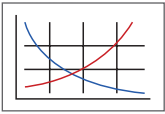

Recommended Cutting Data

Speed and feed recommendations for optimum and safe burnishing

Series	Diameter Range	
	Imperial (inch)	Metric (mm)
H	0.1555 - 0.5028	3.95 - 12.77
I	0.4976 - 0.6634	12.64 - 16.85
K	0.6535 - 0.9740	16.60 - 24.74
L	0.9661 - 1.2268	24.54 - 31.16
F	0.9661 - 1.2268	24.54 - 31.16
M	1.2146 - 1.4118	30.85 - 35.86
N	1.4020 - 1.8492	35.61 - 46.97
O	1.8390 - 2.2240	46.71 - 56.49
P	2.2138 - 2.7240	56.23 - 69.19
Q	2.7138 - 3.3492	68.93 - 85.07
R	3.3390 - 4.0992	84.81 - 104.12
S	4.0890 - 5.0370	103.86 - 127.94
T	5.0354 - 5.9016	127.90 - 149.90
U	5.9016 - 6.5315	149.90 - 165.90



Allied Machine & Engineering offers Roller Burnishing tools through an exclusive supply agreement with S.C.A.M.I. s.n.c.

S.C.A.M.I. is an Italian manufacturer that has been producing high quality cutting tools for over 40 years.

Visit www.alliedmachine.com for additional information about all Allied Machine products, or contact our Application Engineering department for technical assistance.

Introduction Information

Roller Burnishing Overview 2 - 3
 Product Offering 4
 Product Selection Guide 5
 Product Nomenclature 6

Burnishing Series

H Series 7 - 11
 I Series 12 - 13
 K Series 14 - 15
 L Series 16 - 17
 F Series 18 - 19
 M Series 20 - 21
 N Series 22 - 23
 O Series 24 - 25
 P Series 26 - 27
 Q Series 28 - 29
 R Series 30 - 31
 S Series 32 - 33
 T Series 34 - 35
 U Series 36 - 37

Rolls 38 - 39

Technical Information

Diameter Adjustment 40
 How the Burnisher Works 41

Recommended Cutting Data

Imperial (inch) 42 - 43
 Metric (mm) 44 - 45

Roller Burnishing Overview

The Principle of Roller Burnishing

Roller burnishing is a cold-working process that produces a fine surface finish. The planetary rotation of the hardened rolls creates pressure over a metal surface. Unlike cold rolling, which produces large sectional changes, roller burnishing involves cold-working on the surface of the workpiece to improve the surface structure.

All machined surfaces consist of a series of peaks and valleys, all having irregular height and spacing. The plastic deformation created by roller burnishing is a displacement of the material in the peaks. When under pressure, the material in the peaks flows into the valleys. During the process, tool marks and irregularities are rolled out, resulting in a mirror-like finish with a tough, work-hardened surface that is also wear and corrosion resistant.

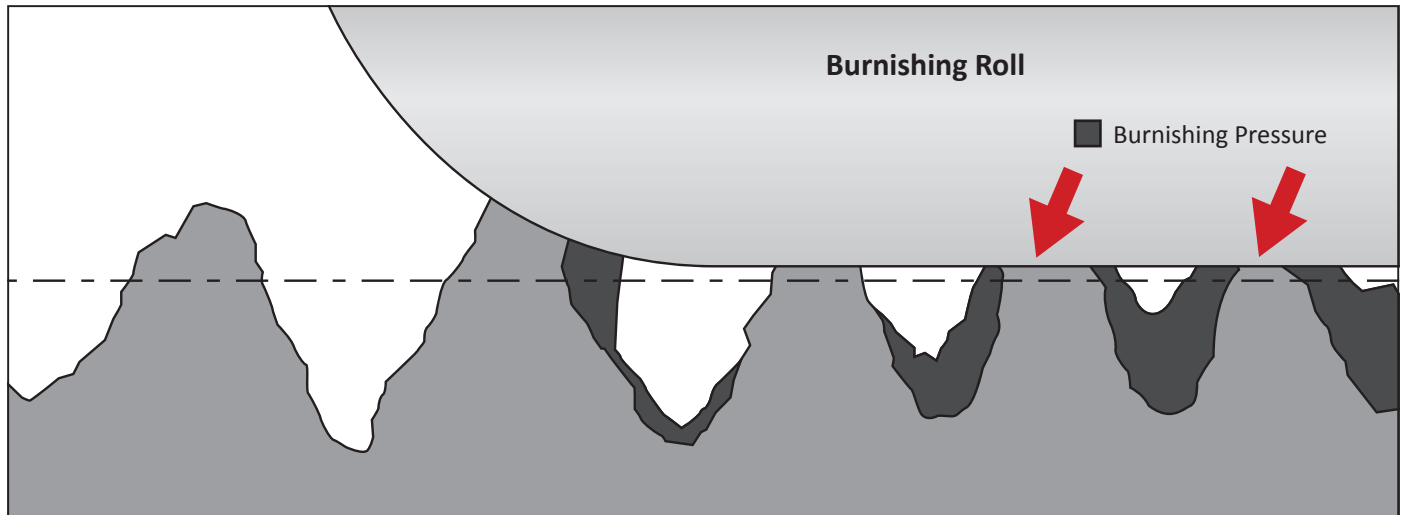

Advantages of Roller Burnishing: Metallurgical Properties

- Grain structure is condensed and refined.
- The compacted surface is **smoother, harder, and more wear resistant** than ground or honed surfaces.
- The process reduces surface porosity and also removes scratches that could hold reactive substances or contaminants. **This increases the corrosion resistance.**
- Depending on the material, the surface hardness can be **increased by as much as 10 points Rockwell C**. This may eliminate the need for heat treatment.
- The plastic deformation induces residual compressive stresses in the surface of the part. This increases the strength properties and fatigue life of the part because any forces on the part must overcome these residual stresses, as well as the tensile strength of the materials, before fatigue conditions occur.

Advantages of Roller Burnishing: Surface Finish

- Creates a high finish to any machinable metal.
- Surfaces that are bored, reamed, or turned to 125 micro inches or more can be finished to 4 micro inch CLA or less in one pass (at feed rates of 125 to 300 mm/min).
- Roller burnishing replaces grinding, honing, lapping, and other expensive secondary operations.
- Tool marks are rolled out.

The Process

- The first contact with the machined surface occurs in Section A.
- Plastic deformation occurs in Section B as the yield point of the surface is exceeded.
- Section D is the pressurized depth.
- Once the material endures the maximum compressive strain (Section C), it starts relieving elastically (Section E) through the finishing zone.
- This leaves a smooth surface and a compressive residual stress of significant peak value.
- The stresses formed on the material during the compression decrease toward the center. These stresses reach approximately 1mm below the surface. This increases the surface hardness.

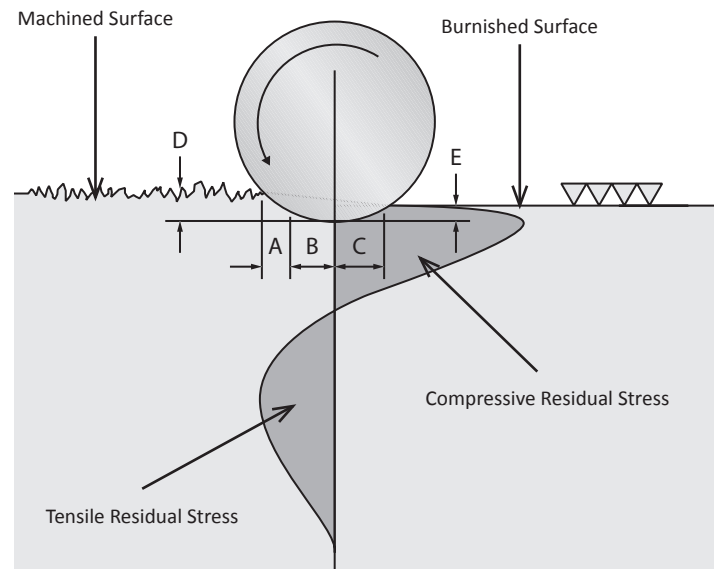

Roller Burnishing Overview

When to Roller Burnish

Conditions for Roller Burnishing

Roller burnishing is a cold working process used to achieve fine hole finishes. In order to achieve the most optimal results, adhere to the benchmarks below:

- **Finishing:** The ductility and hardness of the workpiece material along with the surface preparation dictates the quality of the burnished finish.
- **Workability:** Any ductile and malleable material up to RC40 can be roller burnished.
- **Worked Surface Properties:** Workpieces with an interrupted surface within 10% of the circumference can be successfully burnished with a standard tool (see Figures 1 and 2).

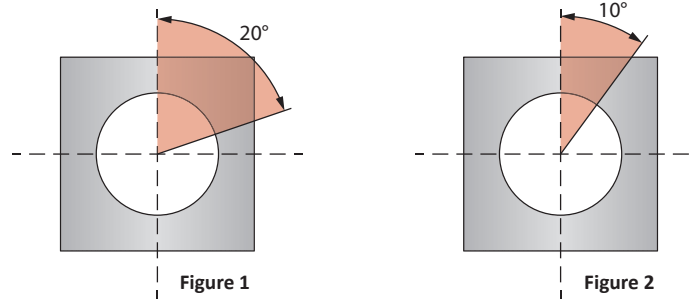

- **Tolerance of the Burnished Piece:** The tolerance range achieved from the burnishing will be equal to that achieved from the pre-machining since no material will be removed.

The ideal surface for burnishing consists of a succession of peaks. These peaks correspond on regular feed of the preparation tool (see Figure 3). We suggest the ALVAN® expandable reamer for pre-burnishing because it creates a uniform roughness and a tolerance range of H6 - H7.

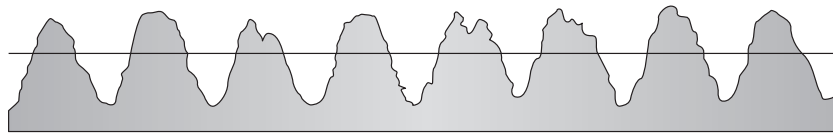

Figure 3

Pre-machining tapers and surface irregularities caused by cutting tool failure must be noted because these conditions cannot be corrected by the roller burnishing process (see Figures 4 and 5).

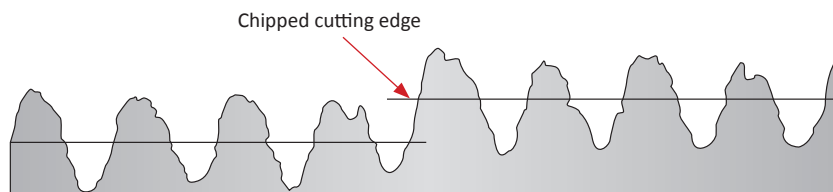

Figure 4

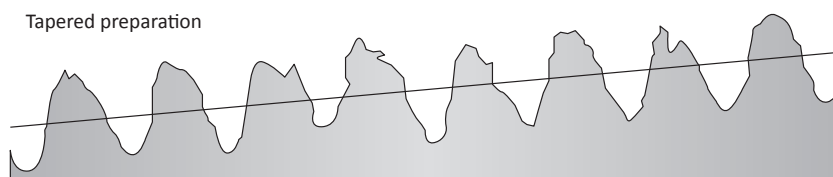

Figure 5

Product Offering



Through Hole Style

0.1555" - 6.5313" (3.95mm - 165.90mm)



Blind Hole Style

0.1850" - 6.5313" (4.70mm - 165.90mm)

Advantages of the Roller Burnishing Tool

- ✔ **Provides accurate size control**
 tolerances within 0.0005" or better (depending on variables such as material)
- ✔ **Produces fine surface finishes**
 between 1 - 10 microinches Ra
- ✔ **Increases surface hardness**
 by 5 - 10% or more
- ✔ **Performs a much cleaner operation**
 than honing or other abrasive finishing methods
- ✔ **Provides versatility**
 because the operation can be performed on any rotating spindle
- ✔ **Eliminates the need for slower and costly finishing processes and secondary operations**
 such as grinding, honing, lapping, etc.

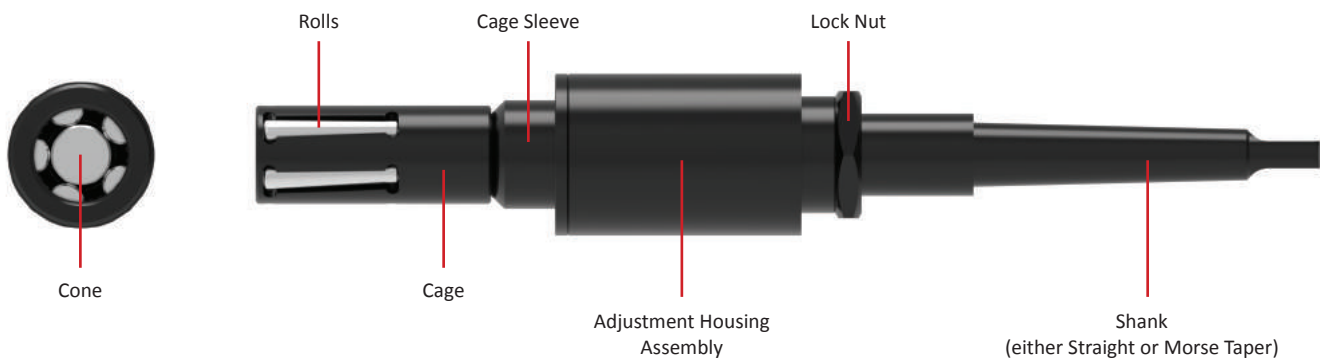

The Tool Components

All roller burnishing tools (both through hole and blind hole) are composed of the basic burnisher assembly, including:

- Cage
- Cone
- Rolls
- Shank (either straight or Morse Taper)

Product Selection Guide

Series	Diameter Range (inch / mm)						Length				
	0 - 1	1 - 2	2 - 3	3 - 4	4 - 5	5 - 6	6 - 7	Short	Standard	Long	Unlimited
	0 - 25.4	25.4 - 50.8	50.8 - 76.2	76.2 - 101.6	101.6 - 127	127 - 152.4	152.4 - 177.8				
H*	█							✓	✓	✓	
I	█							✓	✓	✓	
K		█						✓	✓	✓	
L		█						✓	✓	✓	
F		█									✓
M		█									✓
N			█								✓
O			█								✓
P			█								✓
Q				█							✓
R				█							✓
S					█						✓
T						█					✓
U							█				✓

*For H series: through hole tools start at 0.1555" (3.95mm) and blind hole tools start at 0.1850" (4.70mm)

When to **ORDER UP** 

In some cases, there will be a diameter overlap between a series and the series after it. If the diameter you need falls into this overlap, choose the higher of the two series.

Example:

You need a 24.64mm diameter tool. This diameter falls into both the K series and the L series.

- K series diameter range = 16.60mm - 24.74mm
- L series diameter range = 24.54mm - 31.16mm

In this scenario, you would choose the L series tool that covers the 24.64 diameter.

Product Nomenclature

Roller Burnishing Tools

RDK	H	-	2	1	0	-	004,70
1	2		3	4	5		6

1. Type of Burnisher RDK = Through holes RSK = Blind holes	2. Series H = H series F = F series P = P series T = T series I = I series M = M series Q = Q series U = U series K = K series N = N series R = R series L = L series O = O series S = S series	3. Shank Type 1 = Straight 2 = Morse Taper
4. Length 0 = Unlimited 1 = Short 2 = Standard 3 = Long	5. Cage Style 0 = Standard	6. Diameter Through Hole Tools = Minimum diameter of burnishing range Blind Hole Tools = Diameter to burnish

Cone Reduction Factor (Blind Holes)

When burnishing blind holes, the cone must not extend past the end of the rolls. If it does, the cone will collide with the bottom of the hole. Each burnishing tool has an adjustment range of:

- Approximately 0.5mm on diameter for tools below 12.7mm
- Approximately 1.0mm on diameter for tools above 12.7mm

For through hole burnishing tools, the standard cone value "x" is 1. If the standard cone is used for blind hole burnishing, the only way it will not extend past the end of the rolls is to reduce the length of the cone. The required length reduction is dependent on the set diameter versus the minimum capable diameter of the tool. The factor of reduction (x) can be calculated using the formulas below and will be a whole integer number ranging from 2 - 8.

The "x" value could result in a decimal figure. If so, round down for answers below 0.6, and round up for answers 0.6 and above.

Diameter (5.89mm - 12.77mm) $x = 1 + \frac{Z - Y}{0.05}$ Z = diameter of the hole Y = minimum diameter setting of tool Example: Z = 11.05 Y = 10.71mm $x = 1 + \frac{11.05 - 10.71}{0.05} = 7.8$ which is approximated at "x" = 8 Correct Cone: RSTH-038-11025	Diameter (12.64mm - 127.94mm) $x = 1 + \frac{Z - Y}{0.10}$ Z = diameter of the hole Y = minimum diameter setting of tool Example: Z = 17.76 Y = 17.40mm $x = 1 + \frac{17.76 - 17.40}{0.10} = 4.6$ which is approximated at "x" = 4 Correct Cone: RSTK-034-00044	Diameter (127.90mm - 165.90mm) $x = 1 + \frac{Z - Y}{0.10}$ Z = diameter of the hole Y = minimum diameter setting of tool Example: Z = 148.20 Y = 147.90mm $xx = 31 + \frac{148.20 - 147.90}{0.10} = 34$ Correct Cone: RSTT-034-01480
--	--	--

Reference Key

Symbol	Attribute
D ₁	Diameter range
L ₂	Burnishing length
L ₃	Reference length

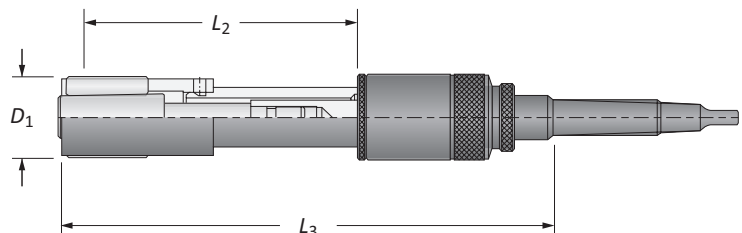



Roller Burnishing Tools | Through Holes

H Series (mini) | Diameter Range: 0.1555" - 0.1870" (3.95mm - 4.75mm)

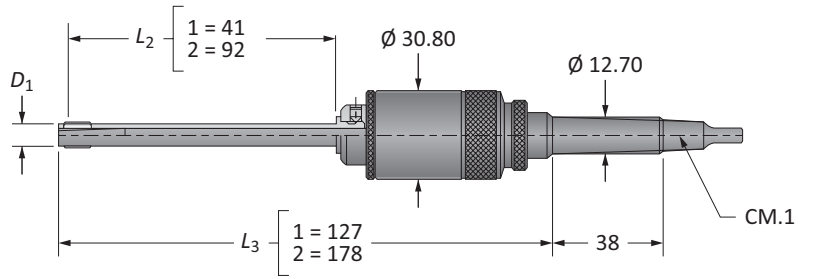

D ₁		L	Part No.		Spare Parts			Qty Rolls
Imperial (in)	Metric (mm)		Assembly with Morse Taper Shank	Assembly with Straight Shank	Cage	Cone	Rolls	
0.1555 - 0.1634	3.95 - 4.15	1	RDKH-212-00395	RDKH-112-00395	RDCH-012-10005	RDTH-031-10012	RDRY-704-00047	3
0.1555 - 0.1634	3.95 - 4.15	2	RDKH-222-00395	RDKH-122-00395	RDCH-012-20005	RDTH-031-20012	RDRY-704-00047	3
0.1638 - 0.1713	4.16 - 4.35	1	RDKH-212-00416	RDKH-112-00416	RDCH-012-10006	RSTH-035-10012	RDRY-704-00047	3
0.1638 - 0.1713	4.16 - 4.35	2	RDKH-222-00416	RDKH-122-00416	RDCH-012-20006	RSTH-035-20012	RDRY-704-00047	3
0.1717 - 0.1791	4.36 - 4.55	1	RDKH-212-00436	RDKH-112-00436	RDCH-012-10007	RDTH-031-10013	RDRY-704-00047	3
0.1717 - 0.1791	4.36 - 4.55	2	RDKH-222-00436	RDKH-122-00436	RDCH-012-20007	RDTH-031-20013	RDRY-704-00047	3
0.1795 - 0.1870	4.56 - 4.75	1	RDKH-212-00456	RDKH-112-00456	RDCH-012-10008	RSTH-035-10013	RDRY-704-00047	3
0.1795 - 0.1870	4.56 - 4.75	2	RDKH-222-00456	RDKH-122-00456	RDCH-012-20008	RSTH-035-20013	RDRY-704-00047	3

NOTE: Each roller burnishing tool comes assembled complete with cage, cone, and rolls.

Key on D: 1

D: 42 - 45

D: 40 - 41

D: 38

Roller Burnishing Tools | Through Holes

H Series | Diameter Range: 0.1850" - 0.5028" (4.70mm - 12.77mm)

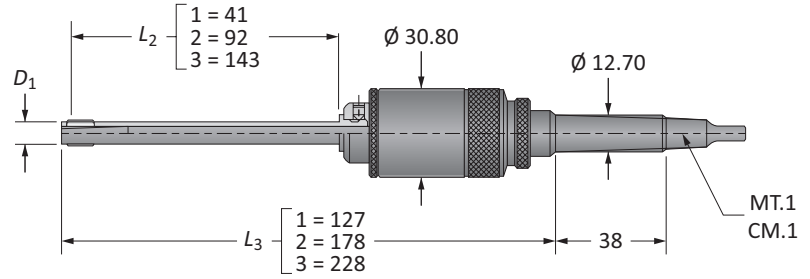

D ₁		L	Part No.		Spare Parts			Qty Rolls
Imperial (in)	Metric (mm)		Assembly with Morse Taper Shank	Assembly with Straight Shank	Cage	Cone	Rolls	
0.1850 - 0.1929	4.70 - 4.90	1	RDKH-210-00470	RDKH-110-00470	RDCH-011-10012	RDTH-031-10012	RDRY-704-00062	3
0.1850 - 0.1929	4.70 - 4.90	2	RDKH-220-00470	RDKH-120-00470	RDCH-011-20012	RDTH-031-20012	RDRY-704-00062	3
0.1850 - 0.1929	4.70 - 4.90	3	RDKH-230-00470	RDKH-130-00470	RDCH-011-30012	RDTH-031-30012	RDRY-704-00062	3
0.1917 - 0.2035	4.87 - 5.17	1	RDKH-210-00487	RDKH-110-00487	RDCH-011-10011	RSTH-033-10012	RDRY-704-00062	3
0.1917 - 0.2035	4.87 - 5.17	2	RDKH-220-00487	RDKH-120-00487	RDCH-011-20011	RSTH-033-20012	RDRY-704-00062	3
0.1917 - 0.2035	4.87 - 5.17	3	RDKH-230-00487	RDKH-130-00487	RDCH-011-30011	RSTH-033-30012	RDRY-704-00062	3
0.1996 - 0.2200	5.07 - 5.59	1	RDKH-210-00507	RDKH-110-00507	RDCH-011-10013	RDTH-031-10013	RDRY-704-00062	5
0.1996 - 0.2200	5.07 - 5.59	2	RDKH-220-00507	RDKH-120-00507	RDCH-011-20013	RDTH-031-20013	RDRY-704-00062	5
0.1996 - 0.2200	5.07 - 5.59	3	RDKH-230-00507	RDKH-130-00507	RDCH-011-30013	RDTH-031-30013	RDRY-704-00062	5
0.2161 - 0.2358	5.49 - 5.99	1	RDKH-210-00549	RDKH-110-00549	RDCH-011-10014	RDTH-031-10013	RDRY-704-00070	5
0.2161 - 0.2358	5.49 - 5.99	2	RDKH-220-00549	RDKH-120-00549	RDCH-011-20014	RDTH-031-20013	RDRY-704-00070	5
0.2161 - 0.2358	5.49 - 5.99	3	RDKH-230-00549	RDKH-130-00549	RDCH-011-30014	RDTH-031-30013	RDRY-704-00070	5
0.2319 - 0.2524	5.89 - 6.41	1	RDKH-210-00589	RDKH-110-00589	RDCH-011-10015	RDTH-031-10015	RDRY-704-00070	5
0.2319 - 0.2524	5.89 - 6.41	2	RDKH-220-00589	RDKH-120-00589	RDCH-011-20015	RDTH-031-20015	RDRY-704-00070	5
0.2319 - 0.2524	5.89 - 6.41	3	RDKH-230-00589	RDKH-130-00589	RDCH-011-30015	RDTH-031-30015	RDRY-704-00070	5
0.2484 - 0.2681	6.31 - 6.81	1	RDKH-210-00631	RDKH-110-00631	RDCH-011-10016	RDTH-031-10015	RDRY-704-00078	5
0.2484 - 0.2681	6.31 - 6.81	2	RDKH-220-00631	RDKH-120-00631	RDCH-011-20016	RDTH-031-20015	RDRY-704-00078	5
0.2484 - 0.2681	6.31 - 6.81	3	RDKH-230-00631	RDKH-130-00631	RDCH-011-30016	RDTH-031-30015	RDRY-704-00078	5
0.2642 - 0.2839	6.71 - 7.21	1	RDKH-210-00671	RDKH-110-00671	RDCH-011-10017	RDTH-031-10017	RDRY-704-00078	5
0.2642 - 0.2839	6.71 - 7.21	2	RDKH-220-00671	RDKH-120-00671	RDCH-011-20017	RDTH-031-20017	RDRY-704-00078	5
0.2642 - 0.2839	6.71 - 7.21	3	RDKH-230-00671	RDKH-130-00671	RDCH-011-30017	RDTH-031-30017	RDRY-704-00078	5
0.2803 - 0.3000	7.12 - 7.62	1	RDKH-210-00712	RDKH-110-00712	RDCH-011-10018	RDTH-031-10017	RDRY-704-00086	5
0.2803 - 0.3000	7.12 - 7.62	2	RDKH-220-00712	RDKH-120-00712	RDCH-011-20018	RDTH-031-20017	RDRY-704-00086	5
0.2803 - 0.3000	7.12 - 7.62	3	RDKH-230-00712	RDKH-130-00712	RDCH-011-30018	RDTH-031-30017	RDRY-704-00086	5
0.2945 - 0.3142	7.48 - 7.98	1	RDKH-210-00748	RDKH-110-00748	RDCH-011-10019	RDTH-031-10019	RDRY-704-00086	5
0.2945 - 0.3142	7.48 - 7.98	2	RDKH-220-00748	RDKH-120-00748	RDCH-011-20019	RDTH-031-20019	RDRY-704-00086	5
0.2945 - 0.3142	7.48 - 7.98	3	RDKH-230-00748	RDKH-130-00748	RDCH-011-30019	RDTH-031-30019	RDRY-704-00086	5
0.3102 - 0.3299	7.88 - 8.38	1	RDKH-210-00788	RDKH-110-00788	RDCH-011-10020	RDTH-031-10019	RDRY-704-00093	5
0.3102 - 0.3299	7.88 - 8.38	2	RDKH-220-00788	RDKH-120-00788	RDCH-011-20020	RDTH-031-20019	RDRY-704-00093	5
0.3102 - 0.3299	7.88 - 8.38	3	RDKH-230-00788	RDKH-130-00788	RDCH-011-30020	RDTH-031-30019	RDRY-704-00093	5
0.3260 - 0.3461	8.28 - 8.79	1	RDKH-210-00828	RDKH-110-00828	RDCH-011-10021	RDTH-031-10021	RDRY-704-00093	5
0.3260 - 0.3461	8.28 - 8.79	2	RDKH-220-00828	RDKH-120-00828	RDCH-011-20021	RDTH-031-20021	RDRY-704-00093	5
0.3260 - 0.3461	8.28 - 8.79	3	RDKH-230-00828	RDKH-130-00828	RDCH-011-30021	RDTH-031-30021	RDRY-704-00093	5

NOTE: Each roller burnishing tool comes assembled complete with cage, cone, and rolls.

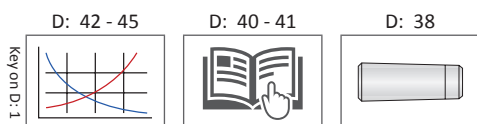



Roller Burnishing Tools | Through Holes (continued)

H Series | Diameter Range: 0.1850" - 0.5028" (4.70mm - 12.77mm)

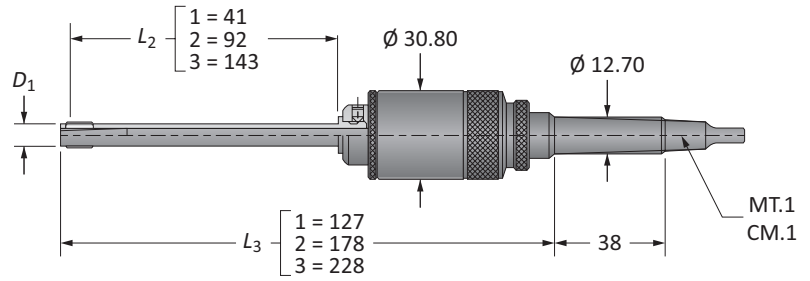

D_1		L	Part No.		Spare Parts			Qty Rolls
Imperial (in)	Metric (mm)		Assembly with Morse Taper Shank	Assembly with Straight Shank	Cage	Cone	Rolls	
0.3410 - 0.3606	8.66 - 9.16	1	RDKH-210-00866	RDKH-110-00866	RDCH-011-10022	RDTH-031-10019	RDRY-704-00109	5
0.3410 - 0.3606	8.66 - 9.16	2	RDKH-220-00866	RDKH-120-00866	RDCH-011-20022	RDTH-031-20019	RDRY-704-00109	5
0.3410 - 0.3606	8.66 - 9.16	3	RDKH-230-00866	RDKH-130-00866	RDCH-011-30022	RDTH-031-30019	RDRY-704-00109	5
0.3567 - 0.3768	9.06 - 9.57	1	RDKH-210-00906	RDKH-110-00906	RDCH-011-10023	RDTH-031-10021	RDRY-704-00109	5
0.3567 - 0.3768	9.06 - 9.57	2	RDKH-220-00906	RDKH-120-00906	RDCH-011-20023	RDTH-031-20021	RDRY-704-00109	5
0.3567 - 0.3768	9.06 - 9.57	3	RDKH-230-00906	RDKH-130-00906	RDCH-011-30023	RDTH-031-30021	RDRY-704-00109	5
0.3732 - 0.3933	9.48 - 9.99	1	RDKH-210-00948	RDKH-110-00948	RDCH-011-10024	RDTH-031-10024	RDRY-704-00109	5
0.3732 - 0.3933	9.48 - 9.99	2	RDKH-220-00948	RDKH-120-00948	RDCH-011-20024	RDTH-031-20024	RDRY-704-00109	5
0.3732 - 0.3933	9.48 - 9.99	3	RDKH-230-00948	RDKH-130-00948	RDCH-011-30024	RDTH-031-30024	RDRY-704-00109	5
0.3902 - 0.4102	9.91 - 10.42	1	RDKH-210-00991	RDKH-110-00991	RDCH-011-10025	RDTH-031-10025	RDRY-704-00109	5
0.3902 - 0.4102	9.91 - 10.42	2	RDKH-220-00991	RDKH-120-00991	RDCH-011-20025	RDTH-031-20025	RDRY-704-00109	5
0.3902 - 0.4102	9.91 - 10.42	3	RDKH-230-00991	RDKH-130-00991	RDCH-011-30025	RDTH-031-30025	RDRY-704-00109	5
0.4051 - 0.4252	10.29 - 10.80	1	RDKH-210-01029	RDKH-110-01029	RDCH-011-10026	RDTH-031-10024	RDRY-704-00125	5
0.4051 - 0.4252	10.29 - 10.80	2	RDKH-220-01029	RDKH-120-01029	RDCH-011-20026	RDTH-031-20024	RDRY-704-00125	5
0.4051 - 0.4252	10.29 - 10.80	3	RDKH-230-01029	RDKH-130-01029	RDCH-011-30026	RDTH-031-30024	RDRY-704-00125	5
0.4217 - 0.4413	10.71 - 11.21	1	RDKH-210-01071	RDKH-110-01071	RDCH-011-10027	RDTH-031-10025	RDRY-704-00125	5
0.4217 - 0.4413	10.71 - 11.21	2	RDKH-220-01071	RDKH-120-01071	RDCH-011-20027	RDTH-031-20025	RDRY-704-00125	5
0.4217 - 0.4413	10.71 - 11.21	3	RDKH-230-01071	RDKH-130-01071	RDCH-011-30027	RDTH-031-30025	RDRY-704-00125	5
0.4374 - 0.4571	11.11 - 11.61	1	RDKH-210-01111	RDKH-110-01111	RDCH-011-10028	RDTH-031-10028	RDRY-704-00125	5
0.4374 - 0.4571	11.11 - 11.61	2	RDKH-220-01111	RDKH-120-01111	RDCH-011-20028	RDTH-031-20028	RDRY-704-00125	5
0.4374 - 0.4571	11.11 - 11.61	3	RDKH-230-01111	RDKH-130-01111	RDCH-011-30028	RDTH-031-30028	RDRY-704-00125	5
0.4512 - 0.4709	11.46 - 11.96	1	RDKH-210-01146	RDKH-110-01146	RDCH-011-10029	RDTH-031-10024	RDRY-704-00148	5
0.4512 - 0.4709	11.46 - 11.96	2	RDKH-220-01146	RDKH-120-01146	RDCH-011-20029	RDTH-031-20024	RDRY-704-00148	5
0.4512 - 0.4709	11.46 - 11.96	3	RDKH-230-01146	RDKH-130-01146	RDCH-011-30029	RDTH-031-30024	RDRY-704-00148	5
0.4681 - 0.4878	11.89 - 12.39	1	RDKH-210-01189	RDKH-110-01189	RDCH-011-10030	RDTH-031-10025	RDRY-704-00148	5
0.4681 - 0.4878	11.89 - 12.39	2	RDKH-220-01189	RDKH-120-01189	RDCH-011-20030	RDTH-031-20025	RDRY-704-00148	5
0.4681 - 0.4878	11.89 - 12.39	3	RDKH-230-01189	RDKH-130-01189	RDCH-011-30030	RDTH-031-30025	RDRY-704-00148	5
0.4831 - 0.5028	12.27 - 12.77	1	RDKH-210-01227	RDKH-110-01227	RDCH-011-10031	RDTH-031-10028	RDRY-704-00148	5
0.4831 - 0.5028	12.27 - 12.77	2	RDKH-220-01227	RDKH-120-01227	RDCH-011-20031	RDTH-031-20028	RDRY-704-00148	5
0.4831 - 0.5028	12.27 - 12.77	3	RDKH-230-01227	RDKH-130-01227	RDCH-011-30031	RDTH-031-30028	RDRY-704-00148	5

NOTE: Each roller burnishing tool comes assembled complete with cage, cone, and rolls.

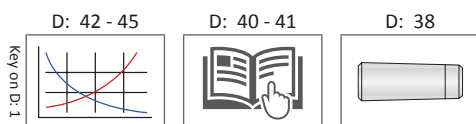

H
A
DRILLING
B
BORING
C
REAMING
D
BURNISHING
E
THREADING
X
SPECIALS

Roller Burnishing Tools | Blind Holes

H Series | Diameter Range: 0.2319" - 0.5028" (5.89mm - 12.77mm)

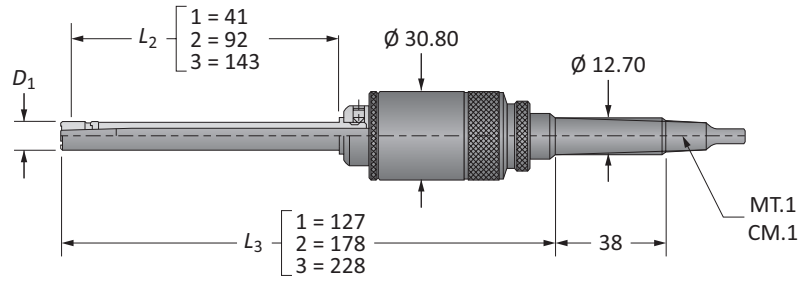

D ₁		L	Part No.*		Spare Parts			Qty Rolls
Imperial (in)	Metric (mm)		Assembly with Morse Taper Shank	Assembly with Straight Shank	Cage	Cone**	Rolls	
0.2319 - 0.2524	5.89 - 6.41	1	RSKH-210-xxxxx	RSKH-110-xxxxx	RSCH-015-10015	RSTH-03x-10012	RSRY-708-00086	3
0.2319 - 0.2524	5.89 - 6.41	2	RSKH-220-xxxxx	RSKH-120-xxxxx	RSCH-015-20015	RSTH-03x-20012	RSRY-708-00086	3
0.2319 - 0.2524	5.89 - 6.41	3	RSKH-230-xxxxx	RSKH-130-xxxxx	RSCH-015-30015	RSTH-03x-30012	RSRY-708-00086	3
0.2484 - 0.2681	6.31 - 6.81	1	RSKH-210-xxxxx	RSKH-110-xxxxx	RSCH-015-10016	RSTH-03x-10013	RSRY-708-00086	3
0.2484 - 0.2681	6.31 - 6.81	2	RSKH-220-xxxxx	RSKH-120-xxxxx	RSCH-015-20016	RSTH-03x-20013	RSRY-708-00086	3
0.2484 - 0.2681	6.31 - 6.81	3	RSKH-230-xxxxx	RSKH-130-xxxxx	RSCH-015-30016	RSTH-03x-30013	RSRY-708-00086	3
0.2642 - 0.2839	6.71 - 7.21	1	RSKH-210-xxxxx	RSKH-110-xxxxx	RSCH-015-10017	RSTH-03x-10015	RSRY-708-00086	3
0.2642 - 0.2839	6.71 - 7.21	2	RSKH-220-xxxxx	RSKH-120-xxxxx	RSCH-015-20017	RSTH-03x-20015	RSRY-708-00086	3
0.2642 - 0.2839	6.71 - 7.21	3	RSKH-230-xxxxx	RSKH-130-xxxxx	RSCH-015-30017	RSTH-03x-30015	RSRY-708-00086	3
0.2803 - 0.3000	7.12 - 7.62	1	RSKH-210-xxxxx	RSKH-110-xxxxx	RSCH-015-10018	RSTH-03x-10017	RSRY-708-00086	3
0.2803 - 0.3000	7.12 - 7.62	2	RSKH-220-xxxxx	RSKH-120-xxxxx	RSCH-015-20018	RSTH-03x-20017	RSRY-708-00086	3
0.2803 - 0.3000	7.12 - 7.62	3	RSKH-230-xxxxx	RSKH-130-xxxxx	RSCH-015-30018	RSTH-03x-30017	RSRY-708-00086	3
0.2945 - 0.3142	7.48 - 7.98	1	RSKH-210-xxxxx	RSKH-110-xxxxx	RSCH-015-10019	RSTH-03x-10019	RSRY-708-00086	3
0.2945 - 0.3142	7.48 - 7.98	2	RSKH-220-xxxxx	RSKH-120-xxxxx	RSCH-015-20019	RSTH-03x-20019	RSRY-708-00086	3
0.2945 - 0.3142	7.48 - 7.98	3	RSKH-230-xxxxx	RSKH-130-xxxxx	RSCH-015-30019	RSTH-03x-30019	RSRY-708-00086	3
0.3102 - 0.3299	7.88 - 8.38	1	RSKH-210-xxxxx	RSKH-110-xxxxx	RSCH-015-10020	RSTH-03x-10021	RSRY-708-00086	3
0.3102 - 0.3299	7.88 - 8.38	2	RSKH-220-xxxxx	RSKH-120-xxxxx	RSCH-015-20020	RSTH-03x-20021	RSRY-708-00086	3
0.3102 - 0.3299	7.88 - 8.38	3	RSKH-230-xxxxx	RSKH-130-xxxxx	RSCH-015-30020	RSTH-03x-30021	RSRY-708-00086	3
0.3260 - 0.3461	8.28 - 8.79	1	RSKH-210-xxxxx	RSKH-110-xxxxx	RSCH-015-10021	RSTH-03x-10024	RSRY-708-00086	3
0.3260 - 0.3461	8.28 - 8.79	2	RSKH-220-xxxxx	RSKH-120-xxxxx	RSCH-015-20021	RSTH-03x-20024	RSRY-708-00086	3
0.3260 - 0.3461	8.28 - 8.79	3	RSKH-230-xxxxx	RSKH-130-xxxxx	RSCH-015-30021	RSTH-03x-30024	RSRY-708-00086	3
0.3410 - 0.3606	8.66 - 9.16	1	RSKH-210-xxxxx	RSKH-110-xxxxx	RSCH-015-10022	RSTH-03x-10015	RSRY-708-00125	3
0.3410 - 0.3606	8.66 - 9.16	2	RSKH-220-xxxxx	RSKH-120-xxxxx	RSCH-015-20022	RSTH-03x-20015	RSRY-708-00125	3
0.3410 - 0.3606	8.66 - 9.16	3	RSKH-230-xxxxx	RSKH-130-xxxxx	RSCH-015-30022	RSTH-03x-30015	RSRY-708-00125	3
0.3567 - 0.3768	9.06 - 9.57	1	RSKH-210-xxxxx	RSKH-110-xxxxx	RSCH-015-10023	RSTH-03x-10017	RSRY-708-00125	3
0.3567 - 0.3768	9.06 - 9.57	2	RSKH-220-xxxxx	RSKH-120-xxxxx	RSCH-015-20023	RSTH-03x-20017	RSRY-708-00125	3
0.3567 - 0.3768	9.06 - 9.57	3	RSKH-230-xxxxx	RSKH-130-xxxxx	RSCH-015-30023	RSTH-03x-30017	RSRY-708-00125	3

*xxxxx = Indicate to 2 metric decimal places the size to be burnished (e.g. short series roller burnisher Ø 10.25mm with MT.1 shank: RSKH-210-01025).

**x = A number that will vary from 2 to 8 depending upon the exact diameter to be burnished. See page D: 6 for the correct identification of the "x" value.

NOTE: Each roller burnishing tool comes assembled complete with cage, cone, and rolls.

D: 42 - 45 D: 40 - 41 D: 39

Key on D: 1

A DRILLING
B BORING
C REAMING
D BURNISHING
E THREADING
X SPECIALS



Roller Burnishing Tools | Blind Holes (continued)

H Series | Diameter Range: 0.2319" - 0.5028" (5.89mm - 12.77mm)

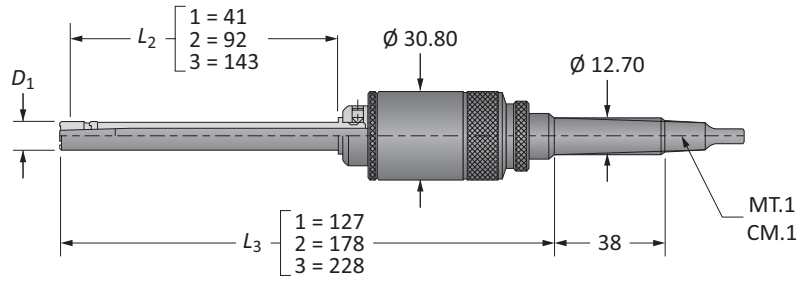

D ₁		L	Part No.*		Spare Parts			Qty Rolls
Imperial (in)	Metric (mm)		Assembly with Morse Taper Shank	Assembly with Straight Shank	Cage	Cone**	Rolls	
0.3732 - 0.3933	9.48 - 9.99	1	RSKH-210-xxxxx	RSKH-110-xxxxx	RSCH-015-10024	RSTH-03x-10019	RSRY-708-00125	3
0.3732 - 0.3933	9.48 - 9.99	2	RSKH-220-xxxxx	RSKH-120-xxxxx	RSCH-015-20024	RSTH-03x-20019	RSRY-708-00125	3
0.3732 - 0.3933	9.48 - 9.99	3	RSKH-230-xxxxx	RSKH-130-xxxxx	RSCH-015-30024	RSTH-03x-30019	RSRY-708-00125	3
0.3902 - 0.4102	9.91 - 10.42	1	RSKH-210-xxxxx	RSKH-110-xxxxx	RSCH-015-10025	RSTH-03x-10021	RSRY-708-00125	3
0.3902 - 0.4102	9.91 - 10.42	2	RSKH-220-xxxxx	RSKH-120-xxxxx	RSCH-015-20025	RSTH-03x-20021	RSRY-708-00125	3
0.3902 - 0.4102	9.91 - 10.42	3	RSKH-230-xxxxx	RSKH-130-xxxxx	RSCH-015-30025	RSTH-03x-30021	RSRY-708-00125	3
0.4051 - 0.4252	10.29 - 10.80	1	RSKH-210-xxxxx	RSKH-110-xxxxx	RSCH-015-10026	RSTH-03x-10024	RSRY-708-00125	3
0.4051 - 0.4252	10.29 - 10.80	2	RSKH-220-xxxxx	RSKH-120-xxxxx	RSCH-015-20026	RSTH-03x-20024	RSRY-708-00125	3
0.4051 - 0.4252	10.29 - 10.80	3	RSKH-230-xxxxx	RSKH-130-xxxxx	RSCH-015-30026	RSTH-03x-30024	RSRY-708-00125	3
0.4217 - 0.4413	10.71 - 11.21	1	RSKH-210-xxxxx	RSKH-110-xxxxx	RSCH-015-10027	RSTH-03x-10025	RSRY-708-00125	3
0.4217 - 0.4413	10.71 - 11.21	2	RSKH-220-xxxxx	RSKH-120-xxxxx	RSCH-015-20027	RSTH-03x-20025	RSRY-708-00125	3
0.4217 - 0.4413	10.71 - 11.21	3	RSKH-230-xxxxx	RSKH-130-xxxxx	RSCH-015-30027	RSTH-03x-30025	RSRY-708-00125	3
0.4374 - 0.4571	11.11 - 11.61	1	RSKH-210-xxxxx	RSKH-110-xxxxx	RSCH-015-10028	RSTH-03x-10028	RSRY-708-00125	3
0.4374 - 0.4571	11.11 - 11.61	2	RSKH-220-xxxxx	RSKH-120-xxxxx	RSCH-015-20028	RSTH-03x-20028	RSRY-708-00125	3
0.4374 - 0.4571	11.11 - 11.61	3	RSKH-230-xxxxx	RSKH-130-xxxxx	RSCH-015-30028	RSTH-03x-30028	RSRY-708-00125	3
0.4512 - 0.4709	11.46 - 11.96	1	RSKH-210-xxxxx	RSKH-110-xxxxx	RSCH-015-10029	RSTH-03x-10021	RSRY-708-00156	3
0.4512 - 0.4709	11.46 - 11.96	2	RSKH-220-xxxxx	RSKH-120-xxxxx	RSCH-015-20029	RSTH-03x-20021	RSRY-708-00156	3
0.4512 - 0.4709	11.46 - 11.96	3	RSKH-230-xxxxx	RSKH-130-xxxxx	RSCH-015-30029	RSTH-03x-30021	RSRY-708-00156	3
0.4681 - 0.4878	11.89 - 12.39	1	RSKH-210-xxxxx	RSKH-110-xxxxx	RSCH-015-10030	RSTH-03x-10024	RSRY-708-00156	3
0.4681 - 0.4878	11.89 - 12.39	2	RSKH-220-xxxxx	RSKH-120-xxxxx	RSCH-015-20030	RSTH-03x-20024	RSRY-708-00156	3
0.4681 - 0.4878	11.89 - 12.39	3	RSKH-230-xxxxx	RSKH-130-xxxxx	RSCH-015-30030	RSTH-03x-30024	RSRY-708-00156	3
0.4831 - 0.5028	12.27 - 12.77	1	RSKH-210-xxxxx	RSKH-110-xxxxx	RSCH-015-10031	RSTH-03x-10025	RSRY-708-00156	3
0.4831 - 0.5028	12.27 - 12.77	2	RSKH-220-xxxxx	RSKH-120-xxxxx	RSCH-015-20031	RSTH-03x-20025	RSRY-708-00156	3
0.4831 - 0.5028	12.27 - 12.77	3	RSKH-230-xxxxx	RSKH-130-xxxxx	RSCH-015-30031	RSTH-03x-30025	RSRY-708-00156	3

*xxxxx = Indicate to 2 metric decimal places the size to be burnished (e.g. short series roller burnisher Ø 10.25mm with MT.1 shank: RSKH-210-01025).

**x = A number that will vary from 2 to 8 depending upon the exact diameter to be burnished. See page D: 6 for the correct identification of the "x" value.

NOTE: Each roller burnishing tool comes assembled complete with cage, cone, and rolls.

Key on D: 1

D: 42 - 45

D: 40 - 41

D: 39

A DRILLING
 B BORING
 C REAMING
 D BURNISHING
 E THREADING
 X SPECIALS

Roller Burnishing Tools | Through Holes

I Series | Diameter Range: 0.4976" - 0.6634" (12.64mm - 16.85mm)

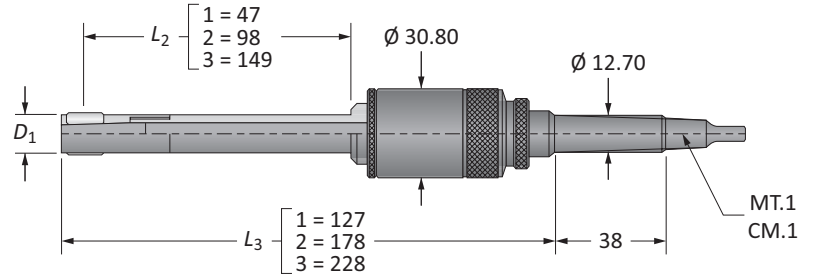

D ₁		L	Part No.		Spare Parts			Qty Rolls
Imperial (in)	Metric (mm)		Assembly with Morse Taper Shank	Assembly with Straight Shank	Cage	Cone	Rolls	
0.4976 - 0.5315	12.64 - 13.50	1	RDKI-210-01264	RDKI-110-01264	RDCI-400-00500	RDTI-031-10032	RDRY-704-00156	5
0.4976 - 0.5315	12.64 - 13.50	2	RDKI-220-01264	RDKI-120-01264	RDCI-400-00500	RDTI-031-20032	RDRY-704-00156	5
0.4976 - 0.5315	12.64 - 13.50	3	RDKI-230-01264	RDKI-130-01264	RDCI-400-00500	RDTI-031-30032	RDRY-704-00156	5
0.5295 - 0.5689	13.45 - 14.45	1	RDKI-210-01345	RDKI-110-01345	RDCI-400-00531	RDTI-031-10034	RDRY-704-00156	5
0.5295 - 0.5689	13.45 - 14.45	2	RDKI-220-01345	RDKI-120-01345	RDCI-400-00531	RDTI-031-20034	RDRY-704-00156	5
0.5295 - 0.5689	13.45 - 14.45	3	RDKI-230-01345	RDKI-130-01345	RDCI-400-00531	RDTI-031-30034	RDRY-704-00156	5
0.5610 - 0.6004	14.25 - 15.25	1	RDKI-210-01425	RDKI-110-01425	RDCI-400-00562	RDTI-031-10034	RDRY-704-00172	5
0.5610 - 0.6004	14.25 - 15.25	2	RDKI-220-01425	RDKI-120-01425	RDCI-400-00562	RDTI-031-20034	RDRY-704-00172	5
0.5610 - 0.6004	14.25 - 15.25	3	RDKI-230-01425	RDKI-130-01425	RDCI-400-00562	RDTI-031-30034	RDRY-704-00172	5
0.5925 - 0.6319	15.05 - 16.05	1	RDKI-210-01505	RDKI-110-01505	RDCI-400-00593	RDTI-031-10038	RDRY-704-00172	5
0.5925 - 0.6319	15.05 - 16.05	2	RDKI-220-01505	RDKI-120-01505	RDCI-400-00593	RDTI-031-20038	RDRY-704-00172	5
0.5925 - 0.6319	15.05 - 16.05	3	RDKI-230-01505	RDKI-130-01505	RDCI-400-00593	RDTI-031-30038	RDRY-704-00172	5
0.6240 - 0.6634	15.85 - 16.85	1	RDKI-210-01585	RDKI-110-01585	RDCI-400-00625	RDTI-031-10038	RDRY-701-00187	5
0.6240 - 0.6634	15.85 - 16.85	2	RDKI-220-01585	RDKI-120-01585	RDCI-400-00625	RDTI-031-20038	RDRY-701-00187	5
0.6240 - 0.6634	15.85 - 16.85	3	RDKI-230-01585	RDKI-130-01585	RDCI-400-00625	RDTI-031-30038	RDRY-701-00187	5

NOTE: Each roller burnishing tool comes assembled complete with cage, cone, and rolls.

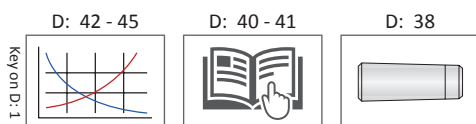



Roller Burnishing Tools | Blind Holes

I Series | Diameter Range: 0.4976" - 0.6634" (12.64mm - 16.85mm)

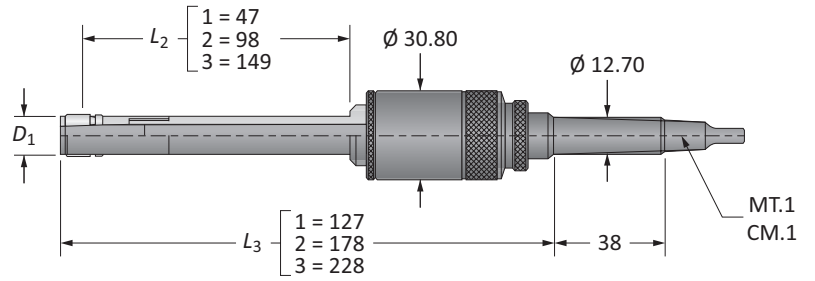

D ₁		L	Part No.*		Spare Parts			Qty Rolls
Imperial (in)	Metric (mm)		Assembly with Morse Taper Shank	Assembly with Straight Shank	Cage	Cone**	Rolls	
0.4976 - 0.5315	12.64 - 13.50	1	RSKI-210-xxxxx	RSKI-110-xxxxx	RSCI-400-00500	RSTI-03X-10032	RSRY-708-00156	5
0.4976 - 0.5315	12.64 - 13.50	2	RSKI-220-xxxxx	RSKI-120-xxxxx	RSCI-400-00500	RSTI-03X-20032	RSRY-708-00156	5
0.4976 - 0.5315	12.64 - 13.50	3	RSKI-230-xxxxx	RSKI-130-xxxxx	RSCI-400-00500	RSTI-03X-30032	RSRY-708-00156	5
0.5295 - 0.5689	13.45 - 14.45	1	RSKI-210-xxxxx	RSKI-110-xxxxx	RSCI-400-00531	RSTI-03X-10034	RSRY-708-00156	5
0.5295 - 0.5689	13.45 - 14.45	2	RSKI-220-xxxxx	RSKI-120-xxxxx	RSCI-400-00531	RSTI-03X-20034	RSRY-708-00156	5
0.5295 - 0.5689	13.45 - 14.45	3	RSKI-230-xxxxx	RSKI-130-xxxxx	RSCI-400-00531	RSTI-03X-30034	RSRY-708-00156	5
0.5610 - 0.6004	14.25 - 15.25	1	RSKI-210-xxxxx	RSKI-110-xxxxx	RSCI-400-00562	RSTI-03X-10034	RSRY-708-00172	5
0.5610 - 0.6004	14.25 - 15.25	2	RSKI-220-xxxxx	RSKI-120-xxxxx	RSCI-400-00562	RSTI-03X-20034	RSRY-708-00172	5
0.5610 - 0.6004	14.25 - 15.25	3	RSKI-230-xxxxx	RSKI-130-xxxxx	RSCI-400-00562	RSTI-03X-30034	RSRY-708-00172	5
0.5925 - 0.6319	15.05 - 16.05	1	RSKI-210-xxxxx	RSKI-110-xxxxx	RSCI-400-00593	RSTI-03X-10038	RSRY-708-00172	5
0.5925 - 0.6319	15.05 - 16.05	2	RSKI-220-xxxxx	RSKI-120-xxxxx	RSCI-400-00593	RSTI-03X-20038	RSRY-708-00172	5
0.5925 - 0.6319	15.05 - 16.05	3	RSKI-230-xxxxx	RSKI-130-xxxxx	RSCI-400-00593	RSTI-03X-30038	RSRY-708-00172	5
0.6240 - 0.6634	15.85 - 16.85	1	RSKI-210-xxxxx	RSKI-110-xxxxx	RSCI-400-00625	RSTI-03X-10038	RSRY-708-00187	5
0.6240 - 0.6634	15.85 - 16.85	2	RSKI-220-xxxxx	RSKI-120-xxxxx	RSCI-400-00625	RSTI-03X-20038	RSRY-708-00187	5
0.6240 - 0.6634	15.85 - 16.85	3	RSKI-230-xxxxx	RSKI-130-xxxxx	RSCI-400-00625	RSTI-03X-30038	RSRY-708-00187	5

*xxxxx = Indicate to 2 metric decimal places the size to be burnished (e.g. long series roller burnisher Ø 14.00mm with MT.1 shank: RSKI-230-01400).

**x = A number that will vary from 2 to 8 depending upon the exact diameter to be burnished. See page D: 6 for the correct identification of the "x" value.

NOTE: Each roller burnishing tool comes assembled complete with cage, cone, and rolls.

D: 42 - 45

D: 40 - 41

D: 39

Key on D: 1

A DRILLING
B BORING
C REAMING
D BURNISHING
E THREADING
X SPECIALS

Roller Burnishing Tools | Through Holes

K Series | Diameter Range: 0.6535" - 0.9740" (16.60mm - 24.74mm)

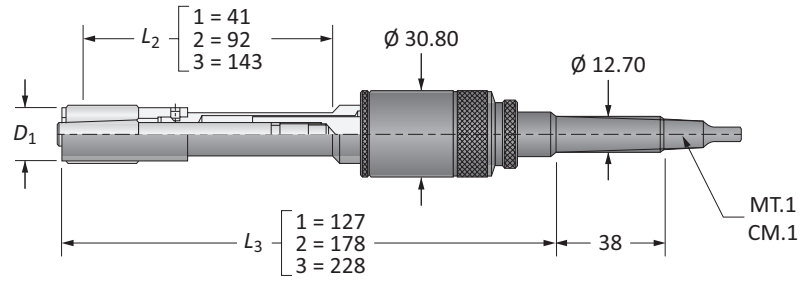

D ₁		L	Part No.		Spare Parts			Qty Rolls
Imperial (in)	Metric (mm)		Assembly with Morse Taper Shank	Assembly with Straight Shank	Cage	Cone	Rolls	
0.6535 - 0.6933	16.60 - 17.61	1	RDKK-210-01660	RDKK-110-01660	RDCK-011-00042	RDTK-031-00042	RDRY-701-00187	5
0.6535 - 0.6933	16.60 - 17.61	2	RDKK-220-01660	RDKK-120-01660	RDCK-011-00042	RDTK-031-00042	RDRY-701-00187	5
0.6535 - 0.6933	16.60 - 17.61	3	RDKK-230-01660	RDKK-130-01660	RDCK-011-00042	RDTK-031-00042	RDRY-701-00187	5
0.6850 - 0.7240	17.40 - 18.39	1	RDKK-210-01740	RDKK-110-01740	RDCK-011-00044	RDTK-031-00044	RDRY-701-00187	5
0.6850 - 0.7240	17.40 - 18.39	2	RDKK-220-01740	RDKK-120-01740	RDCK-011-00044	RDTK-031-00044	RDRY-701-00187	5
0.6850 - 0.7240	17.40 - 18.39	3	RDKK-230-01740	RDKK-130-01740	RDCK-011-00044	RDTK-031-00044	RDRY-701-00187	5
0.7161 - 0.7551	18.19 - 19.18	1	RDKK-210-01819	RDKK-110-01819	RDCK-011-00046	RDTK-031-00042	RDRY-701-00218	5
0.7161 - 0.7551	18.19 - 19.18	2	RDKK-220-01819	RDKK-120-01819	RDCK-011-00046	RDTK-031-00042	RDRY-701-00218	5
0.7161 - 0.7551	18.19 - 19.18	3	RDKK-230-01819	RDKK-130-01819	RDCK-011-00046	RDTK-031-00042	RDRY-701-00218	5
0.7465 - 0.7870	18.96 - 19.99	1	RDKK-210-01896	RDKK-110-01896	RDCK-011-00048	RDTK-031-00044	RDRY-701-00218	5
0.7465 - 0.7870	18.96 - 19.99	2	RDKK-220-01896	RDKK-120-01896	RDCK-011-00048	RDTK-031-00044	RDRY-701-00218	5
0.7465 - 0.7870	18.96 - 19.99	3	RDKK-230-01896	RDKK-130-01896	RDCK-011-00048	RDTK-031-00044	RDRY-701-00218	5
0.7772 - 0.8177	19.74 - 20.77	1	RDKK-210-01974	RDKK-110-01974	RDCK-011-00050	RDTK-031-00050	RDRY-701-00218	5
0.7772 - 0.8177	19.74 - 20.77	2	RDKK-220-01974	RDKK-120-01974	RDCK-011-00050	RDTK-031-00050	RDRY-701-00218	5
0.7772 - 0.8177	19.74 - 20.77	3	RDKK-230-01974	RDKK-130-01974	RDCK-011-00050	RDTK-031-00050	RDRY-701-00218	5
0.8079 - 0.8492	20.52 - 21.57	1	RDKK-210-02052	RDKK-110-02052	RDCK-011-00052	RDTK-031-00052	RDRY-701-00218	5
0.8079 - 0.8492	20.52 - 21.57	2	RDKK-220-02052	RDKK-120-02052	RDCK-011-00052	RDTK-031-00052	RDRY-701-00218	5
0.8079 - 0.8492	20.52 - 21.57	3	RDKK-230-02052	RDKK-130-02052	RDCK-011-00052	RDTK-031-00052	RDRY-701-00218	5
0.8390 - 0.8799	21.31 - 22.35	1	RDKK-210-02131	RDKK-110-02131	RDCK-011-00054	RDTK-031-00054	RDRY-701-00218	5
0.8390 - 0.8799	21.31 - 22.35	2	RDKK-220-02131	RDKK-120-02131	RDCK-011-00054	RDTK-031-00054	RDRY-701-00218	5
0.8390 - 0.8799	21.31 - 22.35	3	RDKK-230-02131	RDKK-130-02131	RDCK-011-00054	RDTK-031-00054	RDRY-701-00218	5
0.8713 - 0.9118	22.13 - 23.16	1	RDKK-210-02213	RDKK-110-02213	RDCK-011-00056	RDTK-031-00050	RDRY-701-00265	5
0.8713 - 0.9118	22.13 - 23.16	2	RDKK-220-02213	RDKK-120-02213	RDCK-011-00056	RDTK-031-00050	RDRY-701-00265	5
0.8713 - 0.9118	22.13 - 23.16	3	RDKK-230-02213	RDKK-130-02213	RDCK-011-00056	RDTK-031-00050	RDRY-701-00265	5
0.9020 - 0.9433	22.91 - 23.96	1	RDKK-210-02291	RDKK-110-02291	RDCK-011-00058	RDTK-031-00052	RDRY-701-00265	5
0.9020 - 0.9433	22.91 - 23.96	2	RDKK-220-02291	RDKK-120-02291	RDCK-011-00058	RDTK-031-00052	RDRY-701-00265	5
0.9020 - 0.9433	22.91 - 23.96	3	RDKK-230-02291	RDKK-130-02291	RDCK-011-00058	RDTK-031-00052	RDRY-701-00265	5
0.9331 - 0.9740	23.70 - 24.74	1	RDKK-210-02370	RDKK-110-02370	RDCK-011-00060	RDTK-031-00054	RDRY-701-00265	5
0.9331 - 0.9740	23.70 - 24.74	2	RDKK-220-02370	RDKK-120-02370	RDCK-011-00060	RDTK-031-00054	RDRY-701-00265	5
0.9331 - 0.9740	23.70 - 24.74	3	RDKK-230-02370	RDKK-130-02370	RDCK-011-00060	RDTK-031-00054	RDRY-701-00265	5

NOTE: Each roller burnishing tool comes assembled complete with cage, cone, and rolls.

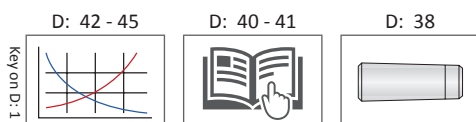



Roller Burnishing Tools | Blind Holes

K Series | Diameter Range: 0.6535" - 0.9740" (16.60mm - 24.74mm)

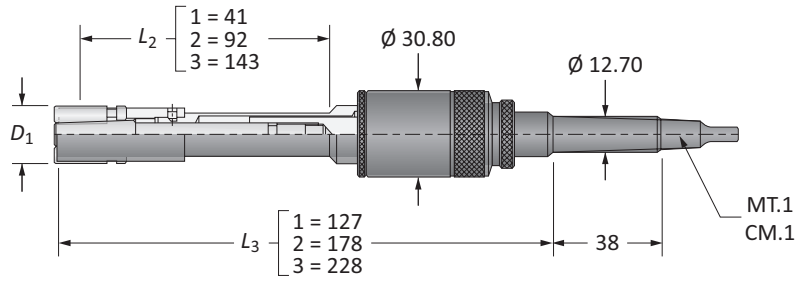

D ₁		L	Part No.*		Spare Parts			Qty Rolls
Imperial (in)	Metric (mm)		Assembly with Morse Taper Shank	Assembly with Straight Shank	Cage	Cone**	Rolls	
0.6535 - 0.6933	16.60 - 17.61	1	RSKK-210-xxxxx	RSKK-110-xxxxx	RSCK-015-00042	RSTK-03x-00042	RSRY-708-00187	5
0.6535 - 0.6933	16.60 - 17.61	2	RSKK-220-xxxxx	RSKK-120-xxxxx	RSCK-015-00042	RSTK-03x-00042	RSRY-708-00187	5
0.6535 - 0.6933	16.60 - 17.61	3	RSKK-230-xxxxx	RSKK-130-xxxxx	RSCK-015-00042	RSTK-03x-00042	RSRY-708-00187	5
0.6850 - 0.7240	17.40 - 18.39	1	RSKK-210-xxxxx	RSKK-110-xxxxx	RSCK-015-00044	RSTK-03x-00044	RSRY-708-00187	5
0.6850 - 0.7240	17.40 - 18.39	2	RSKK-220-xxxxx	RSKK-120-xxxxx	RSCK-015-00044	RSTK-03x-00044	RSRY-708-00187	5
0.6850 - 0.7240	17.40 - 18.39	3	RSKK-230-xxxxx	RSKK-130-xxxxx	RSCK-015-00044	RSTK-03x-00044	RSRY-708-00187	5
0.7161 - 0.7551	18.19 - 19.18	1	RSKK-210-xxxxx	RSKK-110-xxxxx	RSCK-015-00046	RSTK-03x-00042	RSRY-708-00218	5
0.7161 - 0.7551	18.19 - 19.18	2	RSKK-220-xxxxx	RSKK-120-xxxxx	RSCK-015-00046	RSTK-03x-00042	RSRY-708-00218	5
0.7161 - 0.7551	18.19 - 19.18	3	RSKK-230-xxxxx	RSKK-130-xxxxx	RSCK-015-00046	RSTK-03x-00042	RSRY-708-00218	5
0.7465 - 0.7870	18.96 - 19.99	1	RSKK-210-xxxxx	RSKK-110-xxxxx	RSCK-015-00048	RSTK-03x-00044	RSRY-708-00218	5
0.7465 - 0.7870	18.96 - 19.99	2	RSKK-220-xxxxx	RSKK-120-xxxxx	RSCK-015-00048	RSTK-03x-00044	RSRY-708-00218	5
0.7465 - 0.7870	18.96 - 19.99	3	RSKK-230-xxxxx	RSKK-130-xxxxx	RSCK-015-00048	RSTK-03x-00044	RSRY-708-00218	5
0.7772 - 0.8177	19.74 - 20.77	1	RSKK-210-xxxxx	RSKK-110-xxxxx	RSCK-015-00050	RSTK-03x-00050	RSRY-708-00218	5
0.7772 - 0.8177	19.74 - 20.77	2	RSKK-220-xxxxx	RSKK-120-xxxxx	RSCK-015-00050	RSTK-03x-00050	RSRY-708-00218	5
0.7772 - 0.8177	19.74 - 20.77	3	RSKK-230-xxxxx	RSKK-130-xxxxx	RSCK-015-00050	RSTK-03x-00050	RSRY-708-00218	5
0.8079 - 0.8492	20.52 - 21.57	1	RSKK-210-xxxxx	RSKK-110-xxxxx	RSCK-015-00052	RSTK-03x-00052	RSRY-708-00218	5
0.8079 - 0.8492	20.52 - 21.57	2	RSKK-220-xxxxx	RSKK-120-xxxxx	RSCK-015-00052	RSTK-03x-00052	RSRY-708-00218	5
0.8079 - 0.8492	20.52 - 21.57	3	RSKK-230-xxxxx	RSKK-130-xxxxx	RSCK-015-00052	RSTK-03x-00052	RSRY-708-00218	5
0.8390 - 0.8799	21.31 - 22.35	1	RSKK-210-xxxxx	RSKK-110-xxxxx	RSCK-015-00054	RSTK-03x-00054	RSRY-708-00218	5
0.8390 - 0.8799	21.31 - 22.35	2	RSKK-220-xxxxx	RSKK-120-xxxxx	RSCK-015-00054	RSTK-03x-00054	RSRY-708-00218	5
0.8390 - 0.8799	21.31 - 22.35	3	RSKK-230-xxxxx	RSKK-130-xxxxx	RSCK-015-00054	RSTK-03x-00054	RSRY-708-00218	5
0.8713 - 0.9118	22.13 - 23.16	1	RSKK-210-xxxxx	RSKK-110-xxxxx	RSCK-015-00056	RSTK-03x-00050	RSRY-708-00265	5
0.8713 - 0.9118	22.13 - 23.16	2	RSKK-220-xxxxx	RSKK-120-xxxxx	RSCK-015-00056	RSTK-03x-00050	RSRY-708-00265	5
0.8713 - 0.9118	22.13 - 23.16	3	RSKK-230-xxxxx	RSKK-130-xxxxx	RSCK-015-00056	RSTK-03x-00050	RSRY-708-00265	5
0.9020 - 0.9433	22.91 - 23.96	1	RSKK-210-xxxxx	RSKK-110-xxxxx	RSCK-015-00058	RSTK-03x-00052	RSRY-708-00265	5
0.9020 - 0.9433	22.91 - 23.96	2	RSKK-220-xxxxx	RSKK-120-xxxxx	RSCK-015-00058	RSTK-03x-00052	RSRY-708-00265	5
0.9020 - 0.9433	22.91 - 23.96	3	RSKK-230-xxxxx	RSKK-130-xxxxx	RSCK-015-00058	RSTK-03x-00052	RSRY-708-00265	5
0.9331 - 0.9740	23.70 - 24.74	1	RSKK-210-xxxxx	RSKK-110-xxxxx	RSCK-015-00060	RSTK-03x-00054	RSRY-708-00265	5
0.9331 - 0.9740	23.70 - 24.74	2	RSKK-220-xxxxx	RSKK-120-xxxxx	RSCK-015-00060	RSTK-03x-00054	RSRY-708-00265	5
0.9331 - 0.9740	23.70 - 24.74	3	RSKK-230-xxxxx	RSKK-130-xxxxx	RSCK-015-00060	RSTK-03x-00054	RSRY-708-00265	5

*xxxxx = Indicate to 2 metric decimal places the size to be burnished (e.g. standard series roller burnisher Ø 20.00mm with MT.1 shank: RSKK-120-02000).

**x = A number that will vary from 2 to 8 depending upon the exact diameter to be burnished. See page D: 6 for the correct identification of the "x" value.

NOTE: Each roller burnishing tool comes assembled complete with cage, cone, and rolls.

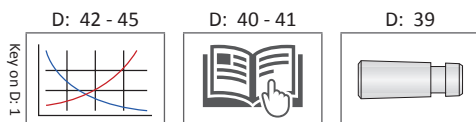

K
A
DRILLING
B
BORING
C
REAMING
D
BURNISHING
E
THREADING
X
SPECIALS

Roller Burnishing Tools | Through Holes

L Series | Diameter Range: 0.9661" - 1.2268" (24.54mm - 31.16mm)

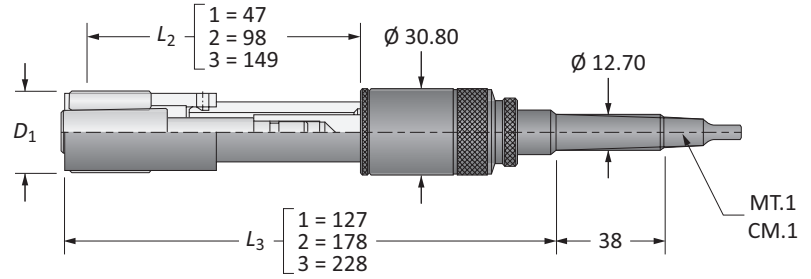

D ₁		L	Part No.		Spare Parts			Qty Rolls
Imperial (in)	Metric (mm)		Assembly with Morse Taper Shank	Assembly with Straight Shank	Cage	Cone	Rolls	
0.9661 - 1.0075	24.54 - 25.59	1	RDKL-210-02454	RDKL-110-02454	RDCL-011-00062	RDTL-031-00062	RDRY-701-00265	5
0.9661 - 1.0075	24.54 - 25.59	2	RDKL-220-02454	RDKL-120-02454	RDCL-011-00062	RDTL-031-00062	RDRY-701-00265	5
0.9661 - 1.0075	24.54 - 25.59	3	RDKL-230-02454	RDKL-130-02454	RDCL-011-00062	RDTL-031-00062	RDRY-701-00265	5
0.9992 - 1.0402	25.38 - 26.42	1	RDKL-210-02538	RDKL-110-02538	RDCL-011-00064	RDTL-031-00064	RDRY-701-00265	7
0.9992 - 1.0402	25.38 - 26.42	2	RDKL-220-02538	RDKL-120-02538	RDCL-011-00064	RDTL-031-00064	RDRY-701-00265	7
0.9992 - 1.0402	25.38 - 26.42	3	RDKL-230-02538	RDKL-130-02538	RDCL-011-00064	RDTL-031-00064	RDRY-701-00265	7
1.0299 - 1.0709	26.16 - 27.20	1	RDKL-210-02616	RDKL-110-02616	RDCL-011-00066	RDTL-031-00066	RDRY-701-00265	7
1.0299 - 1.0709	26.16 - 27.20	2	RDKL-220-02616	RDKL-120-02616	RDCL-011-00066	RDTL-031-00066	RDRY-701-00265	7
1.0299 - 1.0709	26.16 - 27.20	3	RDKL-230-02616	RDKL-130-02616	RDCL-011-00066	RDTL-031-00066	RDRY-701-00265	7
1.0610 - 1.1024	26.95 - 28.00	1	RDKL-210-02695	RDKL-110-02695	RDCL-011-00068	RDTL-031-00068	RDRY-701-00265	7
1.0610 - 1.1024	26.95 - 28.00	2	RDKL-220-02695	RDKL-120-02695	RDCL-011-00068	RDTL-031-00068	RDRY-701-00265	7
1.0610 - 1.1024	26.95 - 28.00	3	RDKL-230-02695	RDKL-130-02695	RDCL-011-00068	RDTL-031-00068	RDRY-701-00265	7
1.0917 - 1.1327	27.73 - 28.77	1	RDKL-210-02773	RDKL-110-02773	RDCL-011-00070	RDTL-031-00070	RDRY-701-00265	7
1.0917 - 1.1327	27.73 - 28.77	2	RDKL-220-02773	RDKL-120-02773	RDCL-011-00070	RDTL-031-00070	RDRY-701-00265	7
1.0917 - 1.1327	27.73 - 28.77	3	RDKL-230-02773	RDKL-130-02773	RDCL-011-00070	RDTL-031-00070	RDRY-701-00265	7
1.1240 - 1.1650	28.55 - 29.59	1	RDKL-210-02855	RDKL-110-02855	RDCL-011-00072	RDTL-031-00066	RDRY-701-00312	7
1.1240 - 1.1650	28.55 - 29.59	2	RDKL-220-02855	RDKL-120-02855	RDCL-011-00072	RDTL-031-00066	RDRY-701-00312	7
1.1240 - 1.1650	28.55 - 29.59	3	RDKL-230-02855	RDKL-130-02855	RDCL-011-00072	RDTL-031-00066	RDRY-701-00312	7
1.1551 - 1.1965	29.34 - 30.39	1	RDKL-210-02934	RDKL-110-02934	RDCL-011-00074	RDTL-031-00068	RDRY-701-00312	7
1.1551 - 1.1965	29.34 - 30.39	2	RDKL-220-02934	RDKL-120-02934	RDCL-011-00074	RDTL-031-00068	RDRY-701-00312	7
1.1551 - 1.1965	29.34 - 30.39	3	RDKL-230-02934	RDKL-130-02934	RDCL-011-00074	RDTL-031-00068	RDRY-701-00312	7
1.1858 - 1.2268	30.12 - 31.16	1	RDKL-210-03012	RDKL-110-03012	RDCL-011-00076	RDTL-031-00070	RDRY-701-00312	7
1.1858 - 1.2268	30.12 - 31.16	2	RDKL-220-03012	RDKL-120-03012	RDCL-011-00076	RDTL-031-00070	RDRY-701-00312	7
1.1858 - 1.2268	30.12 - 31.16	3	RDKL-230-03012	RDKL-130-03012	RDCL-011-00076	RDTL-031-00070	RDRY-701-00312	7

NOTE: Each roller burnishing tool comes assembled complete with cage, cone, and rolls.

Key on D: 1

D: 42 - 45

D: 40 - 41

D: 38



Roller Burnishing Tools | Blind Holes

L Series | Diameter Range: 0.9661" - 1.2268" (24.54mm - 31.16mm)

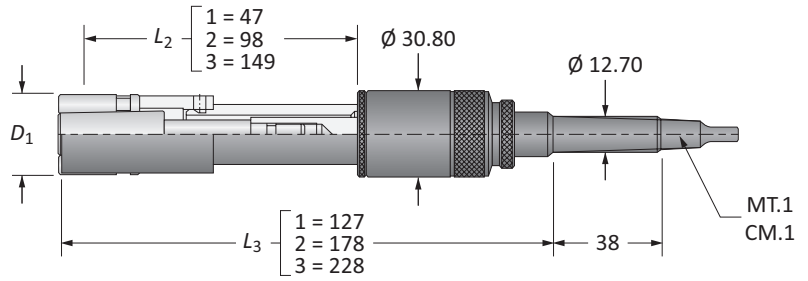

D ₁		L	Part No.*		Spare Parts			Qty Rolls
Imperial (in)	Metric (mm)		Assembly with Morse Taper Shank	Assembly with Straight Shank	Cage	Cone**	Rolls	
0.9661 - 1.0075	24.54 - 25.59	1	RSKL-210-xxxxx	RSKL-110-xxxxx	RSCL-015-00062	RSTL-03x-00062	RSRY-708-00265	5
0.9661 - 1.0075	24.54 - 25.59	2	RSKL-220-xxxxx	RSKL-120-xxxxx	RSCL-015-00062	RSTL-03x-00062	RSRY-708-00265	5
0.9661 - 1.0075	24.54 - 25.59	3	RSKL-230-xxxxx	RSKL-130-xxxxx	RSCL-015-00062	RSTL-03x-00062	RSRY-708-00265	5
0.9992 - 1.0402	25.38 - 26.42	1	RSKL-210-xxxxx	RSKL-110-xxxxx	RSCL-015-00064	RSTL-03x-00064	RSRY-708-00265	5
0.9992 - 1.0402	25.38 - 26.42	2	RSKL-220-xxxxx	RSKL-120-xxxxx	RSCL-015-00064	RSTL-03x-00064	RSRY-708-00265	5
0.9992 - 1.0402	25.38 - 26.42	3	RSKL-230-xxxxx	RSKL-130-xxxxx	RSCL-015-00064	RSTL-03x-00064	RSRY-708-00265	5
1.0299 - 1.0709	26.16 - 27.20	1	RSKL-210-xxxxx	RSKL-110-xxxxx	RSCL-015-00066	RSTL-03x-00066	RSRY-708-00265	5
1.0299 - 1.0709	26.16 - 27.20	2	RSKL-220-xxxxx	RSKL-120-xxxxx	RSCL-015-00066	RSTL-03x-00066	RSRY-708-00265	5
1.0299 - 1.0709	26.16 - 27.20	3	RSKL-230-xxxxx	RSKL-130-xxxxx	RSCL-015-00066	RSTL-03x-00066	RSRY-708-00265	5
1.0610 - 1.1024	26.95 - 28.00	1	RSKL-210-xxxxx	RSKL-110-xxxxx	RSCL-015-00068	RSTL-03x-00068	RSRY-708-00265	5
1.0610 - 1.1024	26.95 - 28.00	2	RSKL-220-xxxxx	RSKL-120-xxxxx	RSCL-015-00068	RSTL-03x-00068	RSRY-708-00265	5
1.0610 - 1.1024	26.95 - 28.00	3	RSKL-230-xxxxx	RSKL-130-xxxxx	RSCL-015-00068	RSTL-03x-00068	RSRY-708-00265	5
1.0917 - 1.1327	27.73 - 28.77	1	RSKL-210-xxxxx	RSKL-110-xxxxx	RSCL-015-00070	RSTL-03x-00070	RSRY-708-00265	5
1.0917 - 1.1327	27.73 - 28.77	2	RSKL-220-xxxxx	RSKL-120-xxxxx	RSCL-015-00070	RSTL-03x-00070	RSRY-708-00265	5
1.0917 - 1.1327	27.73 - 28.77	3	RSKL-230-xxxxx	RSKL-130-xxxxx	RSCL-015-00070	RSTL-03x-00070	RSRY-708-00265	5
1.1240 - 1.1650	28.55 - 29.59	1	RSKL-210-xxxxx	RSKL-110-xxxxx	RSCL-015-00072	RSTL-03x-00066	RSRY-708-00312	5
1.1240 - 1.1650	28.55 - 29.59	2	RSKL-220-xxxxx	RSKL-120-xxxxx	RSCL-015-00072	RSTL-03x-00066	RSRY-708-00312	5
1.1240 - 1.1650	28.55 - 29.59	3	RSKL-230-xxxxx	RSKL-130-xxxxx	RSCL-015-00072	RSTL-03x-00066	RSRY-708-00312	5
1.1551 - 1.1965	29.34 - 30.39	1	RSKL-210-xxxxx	RSKL-110-xxxxx	RSCL-015-00074	RSTL-03x-00068	RSRY-708-00312	5
1.1551 - 1.1965	29.34 - 30.39	2	RSKL-220-xxxxx	RSKL-120-xxxxx	RSCL-015-00074	RSTL-03x-00068	RSRY-708-00312	5
1.1551 - 1.1965	29.34 - 30.39	3	RSKL-230-xxxxx	RSKL-130-xxxxx	RSCL-015-00074	RSTL-03x-00068	RSRY-708-00312	5
1.1858 - 1.2268	30.12 - 31.16	1	RSKL-210-xxxxx	RSKL-110-xxxxx	RSCL-015-00076	RSTL-03x-00070	RSRY-708-00312	5
1.1858 - 1.2268	30.12 - 31.16	2	RSKL-220-xxxxx	RSKL-120-xxxxx	RSCL-015-00076	RSTL-03x-00070	RSRY-708-00312	5
1.1858 - 1.2268	30.12 - 31.16	3	RSKL-230-xxxxx	RSKL-130-xxxxx	RSCL-015-00076	RSTL-03x-00070	RSRY-708-00312	5

*xxxxx = Indicate to 2 metric decimal places the size to be burnished (e.g. short series roller burnisher Ø 27.50mm with MT.1 shank: RSKL-210-02750).

**x = A number that will vary from 2 to 8 depending upon the exact diameter to be burnished. See page D: 6 for the correct identification of the "x" value.

NOTE: Each roller burnishing tool comes assembled complete with cage, cone, and rolls.

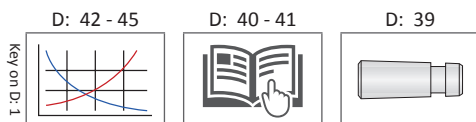

L
A
DRILLING
B
BORING
C
REAMING
D
BURNISHING
E
THREADING
X
SPECIALS

Roller Burnishing Tools | Through Holes

F Series | Diameter Range: 0.9661" - 1.2268" (24.54mm - 31.16mm)

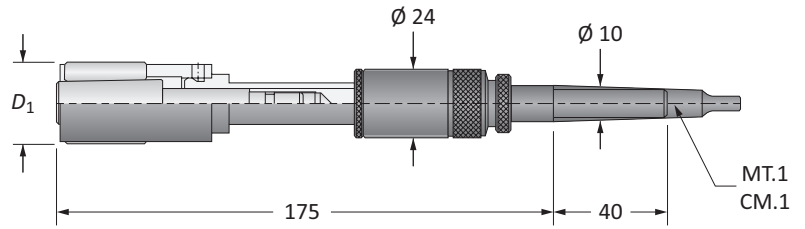

D_1		Part No.		Spare Parts			
Imperial (in)	Metric (mm)	Assembly with Morse Taper Shank	Assembly with Straight Shank	Cage	Cone	Rolls	Qty Rolls
0.9661 - 1.0075	24.54 - 25.59	RDKF-200-02454	RDKF-100-02454	RDCL-011-00062	RDTF-031-00062	RDRY-701-00265	5
0.9992 - 1.0402	25.38 - 26.42	RDKF-200-02538	RDKF-100-02538	RDCL-011-00064	RDTF-031-00064	RDRY-701-00265	7
1.0299 - 1.0709	26.16 - 27.20	RDKF-200-02616	RDKF-100-02616	RDCL-011-00066	RDTF-031-00066	RDRY-701-00265	7
1.0610 - 1.1024	26.95 - 28.00	RDKF-200-02695	RDKF-100-02695	RDCL-011-00068	RDTF-031-00068	RDRY-701-00265	7
1.0917 - 1.1327	27.73 - 28.77	RDKF-200-02773	RDKF-100-02773	RDCL-011-00070	RDTF-031-00070	RDRY-701-00265	7
1.1240 - 1.1650	28.55 - 29.59	RDKF-200-02855	RDKF-100-02855	RDCL-011-00072	RDTF-031-00066	RDRY-701-00312	7
1.1551 - 1.1965	29.34 - 30.39	RDKF-200-02934	RDKF-100-02934	RDCL-011-00074	RDTF-031-00068	RDRY-701-00312	7
1.1858 - 1.2268	30.12 - 31.16	RDKF-200-03012	RDKF-100-03012	RDCL-011-00076	RDTF-031-00070	RDRY-701-00312	7

NOTE: Each roller burnishing tool comes assembled complete with cage, cone, and rolls.

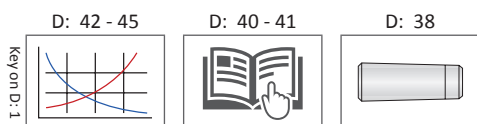



Roller Burnishing Tools | Blind Holes

F Series | Diameter Range: 0.9661" - 1.2268" (24.54mm - 31.16mm)

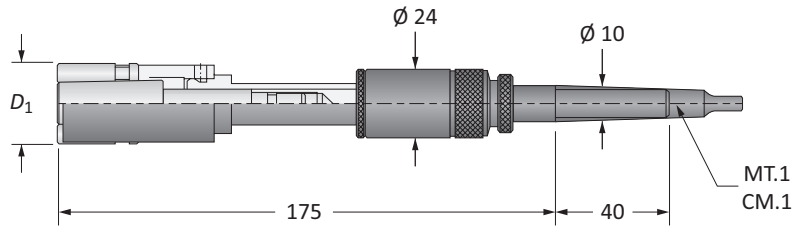

D ₁		Part No.*		Spare Parts				Qty Rolls
Imperial (in)	Metric (mm)	Assembly with Morse Taper Shank	Assembly with Straight Shank	Cage	Cone**	Rolls		
0.9661 - 1.0075	24.54 - 25.59	RSKF-200-xxxxx	RSKF-100-xxxxx	RSCL-015-00062	RSTF-03x-00062	RSRY-708-00265	5	
0.9992 - 1.0402	25.38 - 26.42	RSKF-200-xxxxx	RSKF-100-xxxxx	RSCL-015-00064	RSTF-03x-00064	RSRY-708-00265	5	
1.0299 - 1.0709	26.16 - 27.20	RSKF-200-xxxxx	RSKF-100-xxxxx	RSCL-015-00066	RSTF-03x-00066	RSRY-708-00265	5	
1.0610 - 1.1024	26.95 - 28.00	RSKF-200-xxxxx	RSKF-100-xxxxx	RSCL-015-00068	RSTF-03x-00068	RSRY-708-00265	5	
1.0917 - 1.1327	27.73 - 28.77	RSKF-200-xxxxx	RSKF-100-xxxxx	RSCL-015-00070	RSTF-03x-00070	RSRY-708-00265	5	
1.1240 - 1.1650	28.55 - 29.59	RSKF-200-xxxxx	RSKF-100-xxxxx	RSCL-015-00072	RSTF-03x-00066	RSRY-708-00312	5	
1.1551 - 1.1965	29.34 - 30.39	RSKF-200-xxxxx	RSKF-100-xxxxx	RSCL-015-00074	RSTF-03x-00068	RSRY-708-00312	5	
1.1858 - 1.2268	30.12 - 31.16	RSKF-200-xxxxx	RSKF-100-xxxxx	RSCL-015-00076	RSTF-03x-00070	RSRY-708-00312	5	

*xxxxx = Indicate to 2 metric decimal places the size to be burnished (e.g. roller burnisher Ø 27.00mm with MT.1 shank: RSKF-200-02700).

**x = A number that will vary from 2 to 8 depending upon the exact diameter to be burnished. See page D: 6 for the correct identification of the "x" value.

NOTE: Each roller burnishing tool comes assembled complete with cage, cone, and rolls.

D: 42 - 45 D: 40 - 41 D: 39

Key on D: 1

Roller Burnishing Tools | Through Holes

M Series | Diameter Range: 1.2146" - 1.4118" (30.85mm - 35.86mm)

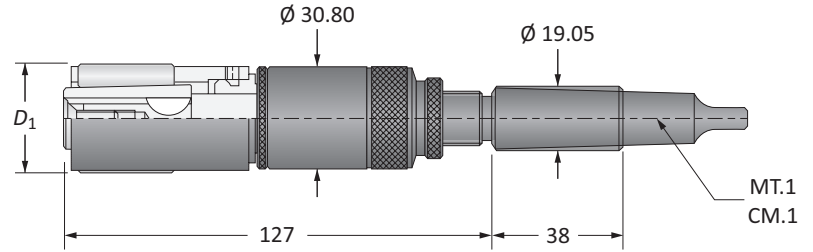

D_1		Part No.		Spare Parts			
Imperial (in)	Metric (mm)	Assembly with Morse Taper Shank	Assembly with Straight Shank	Cage	Cone	Rolls	Qty Rolls
1.2146 - 1.2559	30.85 - 31.90	RDKM-200-03085	RDKM-100-03085	RDCM-011-00078	RDTM-031-00078	RDRY-701-00265	7
1.2469 - 1.2878	31.67 - 32.71	RDKM-200-03167	RDKM-100-03167	RDCM-011-00080	RDTM-031-00080	RDRY-701-00265	7
1.2772 - 1.3177	32.44 - 33.47	RDKM-200-03244	RDKM-100-03244	RDCM-011-00082	RDTM-031-00082	RDRY-701-00265	7
1.3087 - 1.3500	33.24 - 34.29	RDKM-200-03324	RDKM-100-03324	RDCM-011-00084	RDTM-031-00078	RDRY-701-00312	7
1.3406 - 1.3815	34.05 - 35.09	RDKM-200-03405	RDKM-100-03405	RDCM-011-00086	RDTM-031-00080	RDRY-701-00312	7
1.3713 - 1.4118	34.83 - 35.86	RDKM-200-03483	RDKM-100-03483	RDCM-011-00088	RDTM-031-00082	RDRY-701-00312	7

NOTE: Each roller burnishing tool comes assembled complete with cage, cone, and rolls.

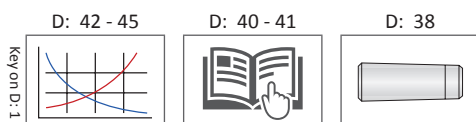



Roller Burnishing Tools | Blind Holes

M Series | Diameter Range: 1.2146" - 1.4118" (30.85mm - 35.86mm)

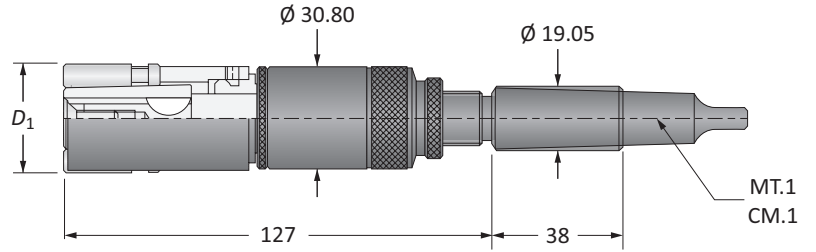

D ₁		Part No.*		Spare Parts			Qty Rolls
Imperial (in)	Metric (mm)	Assembly with Morse Taper Shank	Assembly with Straight Shank	Cage	Cone**	Rolls	
1.2146 - 1.2559	30.85 - 31.90	RSKM-200-xxxxx	RSKM-100-xxxxx	RSCM-015-00078	RSTM-03x-00078	RSRY-708-00265	5
1.2469 - 1.2878	31.67 - 32.71	RSKM-200-xxxxx	RSKM-100-xxxxx	RSCM-015-00080	RSTM-03x-00080	RSRY-708-00265	5
1.2772 - 1.3177	32.44 - 33.47	RSKM-200-xxxxx	RSKM-100-xxxxx	RSCM-015-00082	RSTM-03x-00082	RSRY-708-00265	5
1.3087 - 1.3500	33.24 - 34.29	RSKM-200-xxxxx	RSKM-100-xxxxx	RSCM-015-00084	RSTM-03x-00078	RSRY-708-00312	5
1.3406 - 1.3815	34.05 - 35.09	RSKM-200-xxxxx	RSKM-100-xxxxx	RSCM-015-00086	RSTM-03x-00080	RSRY-708-00312	5
1.3713 - 1.4118	34.83 - 35.86	RSKM-200-xxxxx	RSKM-100-xxxxx	RSCM-015-00088	RSTM-03x-00082	RSRY-708-00312	5

*xxxxx = Indicate to 2 metric decimal places the size to be burnished (e.g. roller burnisher Ø 35.00mm with MT.2 shank: RSKM-200-03500).

**x = A number that will vary from 2 to 8 depending upon the exact diameter to be burnished. See page D: 6 for the correct identification of the "x" value.

NOTE: Each roller burnishing tool comes assembled complete with cage, cone, and rolls.

D: 42 - 45

D: 40 - 41

D: 39

Key on D: 1

N

 BURNISHING | S.C.A.M.I.® Roller Burnishing Systems

A

Roller Burnishing Tools | Through Holes

N Series | Diameter Range: 1.4020" - 1.8492" (35.61mm - 46.97mm)

DRILLING

B

BORING

D_1		Part No.		Spare Parts			
Imperial (in)	Metric (mm)	Assembly with Morse Taper Shank	Assembly with Straight Shank	Cage	Cone	Rolls	Qty Rolls
1.4020 - 1.4433	35.61 - 36.66	RDKN-200-03561	RDKN-100-03561	RDCN-011-00090	RDTN-031-00090	RDRY-701-00312	7
1.4331 - 1.4740	36.40 - 37.44	RDKN-200-03640	RDKN-100-03640	RDCN-011-00092	RDTN-031-00092	RDRY-701-00312	7
1.4638 - 1.5051	37.18 - 38.23	RDKN-200-03718	RDKN-100-03718	RDCN-011-00094	RDTN-031-00094	RDRY-701-00312	7
1.4961 - 1.5370	38.00 - 39.04	RDKN-200-03800	RDKN-100-03800	RDCN-011-00096	RDTN-031-00096	RDRY-701-00312	7
1.5272 - 1.5677	38.79 - 39.82	RDKN-200-03879	RDKN-100-03879	RDCN-011-00098	RDTM-031-00080	RDRY-701-00406	7
1.5579 - 1.5992	39.57 - 40.62	RDKN-200-03957	RDKN-100-03957	RDCN-011-00100	RDTM-031-00082	RDRY-701-00406	7
1.5890 - 1.6299	40.36 - 41.40	RDKN-200-04036	RDKN-100-04036	RDCN-011-00102	RDTN-031-00090	RDRY-701-00406	7
1.6213 - 1.6618	41.18 - 42.21	RDKN-200-04118	RDKN-100-04118	RDCN-011-00104	RDTN-031-00092	RDRY-701-00406	7
1.6520 - 1.6933	41.96 - 43.01	RDKN-200-04196	RDKN-100-04196	RDCN-011-00106	RDTN-031-00094	RDRY-701-00406	7
1.6831 - 1.7240	42.75 - 43.79	RDKN-200-04275	RDKN-100-04275	RDCN-011-00108	RDTM-031-00082	RDRY-701-00468	7
1.7138 - 1.7551	43.53 - 44.58	RDKN-200-04353	RDKN-100-04353	RDCN-011-00110	RDTN-031-00090	RDRY-701-00468	7
1.7461 - 1.7870	44.35 - 45.39	RDKN-200-04435	RDKN-100-04435	RDCN-011-00112	RDTN-031-00092	RDRY-701-00468	7
1.7772 - 1.8177	45.14 - 46.17	RDKN-200-04514	RDKN-100-04514	RDCN-011-00114	RDTN-031-00094	RDRY-701-00468	7
1.8079 - 1.8492	45.92 - 46.97	RDKN-200-04592	RDKN-100-04592	RDCN-011-00116	RDTN-031-00096	RDRY-701-00468	7

NOTE: Each roller burnishing tool comes assembled complete with cage, cone, and rolls.

D

BURNISHING

F

THREADING

X

SPECIALS

Key on D: 1

D: 42 - 45

D: 40 - 41

D: 38

D: 22

www.alliedmachine.com | 1.330.343.4283



Roller Burnishing Tools | Blind Holes

N Series | Diameter Range: 1.4020" - 1.8492" (35.61mm - 46.97mm)

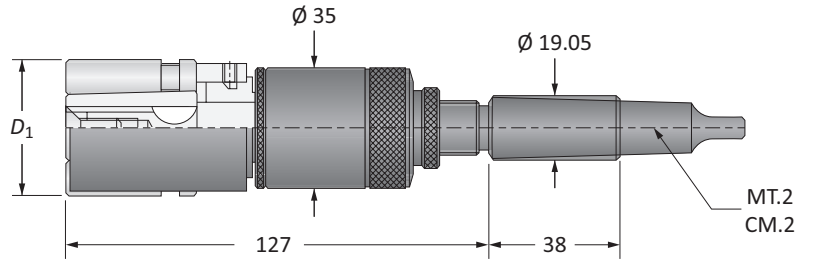

D_1		Part No.*		Spare Parts			Qty Rolls
Imperial (in)	Metric (mm)	Assembly with Morse Taper Shank	Assembly with Straight Shank	Cage	Cone**	Rolls	
1.4020 - 1.4433	35.61 - 36.66	RSKN-200-xxxxx	RSKN-100-xxxxx	RSCN-015-00090	RSTN-03x-00090	RSRY-708-00312	5
1.4331 - 1.4740	36.40 - 37.44	RSKN-200-xxxxx	RSKN-100-xxxxx	RSCN-015-00092	RSTN-03x-00092	RSRY-708-00312	5
1.4638 - 1.5051	37.18 - 38.23	RSKN-200-xxxxx	RSKN-100-xxxxx	RSCN-015-00094	RSTN-03x-00094	RSRY-708-00312	5
1.4961 - 1.5370	38.00 - 39.04	RSKN-200-xxxxx	RSKN-100-xxxxx	RSCN-015-00096	RSTN-03x-00096	RSRY-708-00312	5
1.5272 - 1.5677	38.79 - 39.82	RSKN-200-xxxxx	RSKN-100-xxxxx	RSCN-015-00098	RSTM-03x-00080	RSRY-708-00406	5
1.5579 - 1.5992	39.57 - 40.62	RSKN-200-xxxxx	RSKN-100-xxxxx	RSCN-015-00100	RSTM-03x-00082	RSRY-708-00406	5
1.5890 - 1.6299	40.36 - 41.40	RSKN-200-xxxxx	RSKN-100-xxxxx	RSCN-015-00102	RSTN-03x-00090	RSRY-708-00406	5
1.6213 - 1.6618	41.18 - 42.21	RSKN-200-xxxxx	RSKN-100-xxxxx	RSCN-015-00104	RSTN-03x-00092	RSRY-708-00406	5
1.6520 - 1.6933	41.96 - 43.01	RSKN-200-xxxxx	RSKN-100-xxxxx	RSCN-015-00106	RSTN-03x-00094	RSRY-708-00406	5
1.6831 - 1.7240	42.75 - 43.79	RSKN-200-xxxxx	RSKN-100-xxxxx	RSCN-015-00108	RSTM-03x-00082	RSRY-708-00468	5
1.7138 - 1.7551	43.53 - 44.58	RSKN-200-xxxxx	RSKN-100-xxxxx	RSCN-015-00110	RSTN-03x-00090	RSRY-708-00468	5
1.7461 - 1.7870	44.35 - 45.39	RSKN-200-xxxxx	RSKN-100-xxxxx	RSCN-015-00112	RSTN-03x-00092	RSRY-708-00468	5
1.7772 - 1.8177	45.14 - 46.17	RSKN-200-xxxxx	RSKN-100-xxxxx	RSCN-015-00114	RSTN-03x-00094	RSRY-708-00468	5
1.8079 - 1.8492	45.92 - 46.97	RSKN-200-xxxxx	RSKN-100-xxxxx	RSCN-015-00116	RSTN-03x-00096	RSRY-708-00468	5

*xxxxx = Indicate to 2 metric decimal places the size to be burnished (e.g. roller burnisher \varnothing 40.00mm with straight shank: RSKN-100-04000).

**x = A number that will vary from 2 to 8 depending upon the exact diameter to be burnished. See page D: 6 for the correct identification of the "x" value.

NOTE: Each roller burnishing tool comes assembled complete with cage, cone, and rolls.

Key on D: 1

D: 42 - 45

D: 40 - 41

D: 39

Roller Burnishing Tools | Through Holes

O Series | Diameter Range: 1.8390" - 2.2240" (46.71mm - 56.49mm)

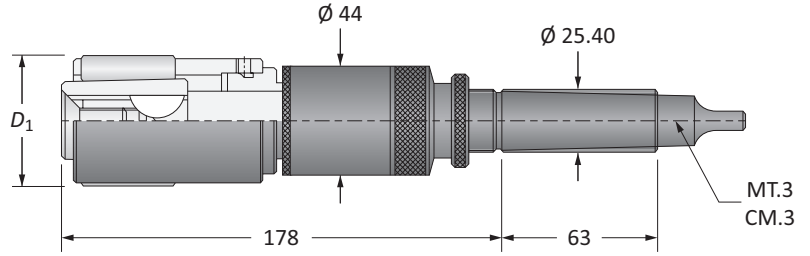

Through Holes

D ₁		Part No.		Spare Parts			
Imperial (in)	Metric (mm)	Assembly with Morse Taper Shank	Assembly with Straight Shank	Cage	Cone	Rolls	Qty Rolls
1.8390 - 1.8799	46.71 - 47.75	RDKO-200-04671	RDKO-100-04671	RDCO-011-00118	RDTO-031-00118	RDRY-701-00312	9
1.8713 - 1.9118	47.53 - 48.56	RDKO-200-04753	RDKO-100-04753	RDCO-011-00120	RDTO-031-00120	RDRY-701-00312	9
1.9020 - 1.9433	48.31 - 49.36	RDKO-200-04831	RDKO-100-04831	RDCO-011-00122	RDTO-031-00122	RDRY-701-00312	9
1.9331 - 1.9740	49.10 - 50.14	RDKO-200-04910	RDKO-100-04910	RDCO-011-00124	RDTO-031-00124	RDRY-701-00312	9
1.9638 - 2.0051	49.88 - 50.93	RDKO-200-04988	RDKO-100-04988	RDCO-011-00126	RDTO-031-00126	RDRY-701-00312	9
1.9961 - 2.0370	50.70 - 51.74	RDKO-200-05070	RDKO-100-05070	RDCO-011-00128	RDTO-031-00128	RDRY-701-00312	9
2.0272 - 2.0681	51.49 - 52.53	RDKO-200-05149	RDKO-100-05149	RDCO-011-00130	RDTO-031-00118	RDRY-701-00406	9
2.0579 - 2.0992	52.27 - 53.32	RDKO-200-05227	RDKO-100-05227	RDCO-011-00132	RDTO-031-00120	RDRY-701-00406	9
2.0890 - 2.1299	53.06 - 54.10	RDKO-200-05306	RDKO-100-05306	RDCO-011-00134	RDTO-031-00122	RDRY-701-00406	9
2.1209 - 2.1618	53.87 - 54.91	RDKO-200-05387	RDKO-100-05387	RDCO-011-00136	RDTO-031-00124	RDRY-701-00406	9
2.1520 - 2.1933	54.66 - 55.71	RDKO-200-05466	RDKO-100-05466	RDCO-011-00138	RDTO-031-00126	RDRY-701-00406	9
2.1831 - 2.2240	55.45 - 56.49	RDKO-200-05545	RDKO-100-05545	RDCO-011-00140	RDTO-031-00128	RDRY-701-00406	9

NOTE: Each roller burnishing tool comes assembled complete with cage, cone, and rolls.

D: 42 - 45

D: 40 - 41

D: 38

Key on D: 1



Roller Burnishing Tools | Blind Holes

O Series | Diameter Range: 1.8390" - 2.2240" (46.71mm - 56.49mm)

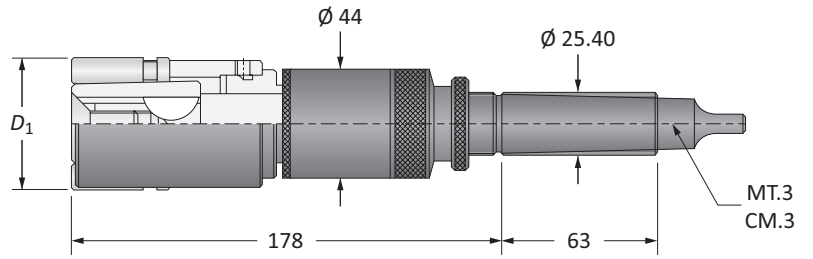

Blind Holes

D_1		Part No.*		Spare Parts			Qty Rolls
Imperial (in)	Metric (mm)	Assembly with Morse Taper Shank	Assembly with Straight Shank	Cage	Cone**	Rolls	
1.8390 - 1.8799	46.71 - 47.75	RSKO-200-xxxxx	RSKO-100-xxxxx	RSCO-015-00118	RSTO-03x-00118	RSRY-708-00312	7
1.8713 - 1.9118	47.53 - 48.56	RSKO-200-xxxxx	RSKO-100-xxxxx	RSCO-015-00120	RSTO-03x-00120	RSRY-708-00312	7
1.9020 - 1.9433	48.31 - 49.36	RSKO-200-xxxxx	RSKO-100-xxxxx	RSCO-015-00122	RSTO-03x-00122	RSRY-708-00312	7
1.9331 - 1.9740	49.10 - 50.14	RSKO-200-xxxxx	RSKO-100-xxxxx	RSCO-015-00124	RSTO-03x-00124	RSRY-708-00312	7
1.9638 - 2.0051	49.88 - 50.93	RSKO-200-xxxxx	RSKO-100-xxxxx	RSCO-015-00126	RSTO-03x-00126	RSRY-708-00312	7
1.9961 - 2.0370	50.70 - 51.74	RSKO-200-xxxxx	RSKO-100-xxxxx	RSCO-015-00128	RSTO-03x-00128	RSRY-708-00312	7
2.0272 - 2.0681	51.49 - 52.53	RSKO-200-xxxxx	RSKO-100-xxxxx	RSCO-015-00130	RSTO-03x-00118	RSRY-708-00406	7
2.0579 - 2.0992	52.27 - 53.32	RSKO-200-xxxxx	RSKO-100-xxxxx	RSCO-015-00132	RSTO-03x-00120	RSRY-708-00406	7
2.0890 - 2.1299	53.06 - 54.10	RSKO-200-xxxxx	RSKO-100-xxxxx	RSCO-015-00134	RSTO-03x-00122	RSRY-708-00406	7
2.1209 - 2.1618	53.87 - 54.91	RSKO-200-xxxxx	RSKO-100-xxxxx	RSCO-015-00136	RSTO-03x-00124	RSRY-708-00406	7
2.1520 - 2.1933	54.66 - 55.71	RSKO-200-xxxxx	RSKO-100-xxxxx	RSCO-015-00138	RSTO-03x-00126	RSRY-708-00406	7
2.1831 - 2.2240	55.45 - 56.49	RSKO-200-xxxxx	RSKO-100-xxxxx	RSCO-015-00140	RSTO-03x-00128	RSRY-708-00406	7

*xxxxx = Indicate to 2 metric decimal places the size to be burnished (e.g. roller burnisher Ø 50.25mm with MT.3 shank: RSKO-200-05025).

**x = A number that will vary from 2 to 8 depending upon the exact diameter to be burnished. See page D: 6 for the correct identification of the "x" value.

NOTE: Each roller burnishing tool comes assembled complete with cage, cone, and rolls.

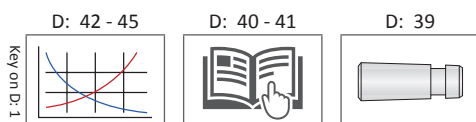

Roller Burnishing Tools | Through Holes

P Series | Diameter Range: 2.2138" - 2.7240" (56.23mm - 69.19mm)

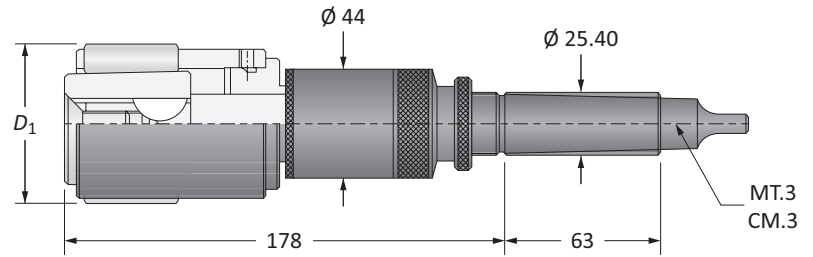

Through Holes

D_1		Part No.		Spare Parts			
Imperial (in)	Metric (mm)	Assembly with Morse Taper Shank	Assembly with Straight Shank	Cage	Cone	Rolls	Qty Rolls
2.2138 - 2.2551	56.23 - 57.28	RDKP-200-05623	RDKP-100-05623	RDCP-011-00142	RDTP-031-00142	RDRY-701-00406	9
2.2461 - 2.2870	57.05 - 58.09	RDKP-200-05705	RDKP-100-05705	RDCP-011-00144	RDTP-031-00144	RDRY-701-00406	9
2.2772 - 2.3177	57.84 - 58.87	RDKP-200-05784	RDKP-100-05784	RDCP-011-00146	RDTP-031-00146	RDRY-701-00406	9
2.3079 - 2.3492	58.62 - 59.67	RDKP-200-05862	RDKP-100-05862	RDCP-011-00148	RDTP-031-00148	RDRY-701-00406	9
2.3390 - 2.3799	59.41 - 60.45	RDKP-200-05941	RDKP-100-05941	RDCP-011-00150	RDTP-031-00142	RDRY-701-00468	9
2.3713 - 2.4118	60.23 - 61.26	RDKP-200-06023	RDKP-100-06023	RDCP-011-00152	RDTP-031-00144	RDRY-701-00468	9
2.4020 - 2.4433	61.01 - 62.06	RDKP-200-06101	RDKP-100-06101	RDCP-011-00154	RDTP-031-00146	RDRY-701-00468	9
2.4330 - 2.4740	61.80 - 62.84	RDKP-200-06180	RDKP-100-06180	RDCP-011-00156	RDTP-031-00148	RDRY-701-00468	9
2.4638 - 2.5051	62.58 - 63.63	RDKP-200-06258	RDKP-100-06258	RDCP-011-00158	RDTP-031-00158	RDRY-701-00468	9
2.4961 - 2.5370	63.40 - 64.44	RDKP-200-06340	RDKP-100-06340	RDCP-011-00160	RDTP-031-00160	RDRY-701-00468	9
2.5272 - 2.5677	64.19 - 65.22	RDKP-200-06419	RDKP-100-06419	RDCP-011-00162	RDTP-031-00162	RDRY-701-00468	9
2.5579 - 2.5992	64.97 - 66.02	RDKP-200-06497	RDKP-100-06497	RDCP-011-00164	RDTP-031-00164	RDRY-701-00468	9
2.5890 - 2.6299	65.76 - 66.80	RDKP-200-06576	RDKP-100-06576	RDCP-011-00166	RDTP-031-00158	RDRY-701-00531	9
2.6213 - 2.6618	66.58 - 67.61	RDKP-200-06658	RDKP-100-06658	RDCP-011-00168	RDTP-031-00160	RDRY-701-00531	9
2.6520 - 2.6933	67.36 - 68.41	RDKP-200-06736	RDKP-100-06736	RDCP-011-00170	RDTP-031-00162	RDRY-701-00531	9
2.6830 - 2.7240	68.15 - 69.19	RDKP-200-06815	RDKP-100-06815	RDCP-011-00172	RDTP-031-00164	RDRY-701-00531	9

NOTE: Each roller burnishing tool comes assembled complete with cage, cone, and rolls.

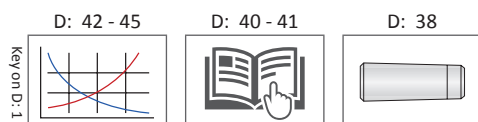



Roller Burnishing Tools | Blind Holes

P Series | Diameter Range: 2.2138" - 2.7240" (56.23mm - 69.19mm)

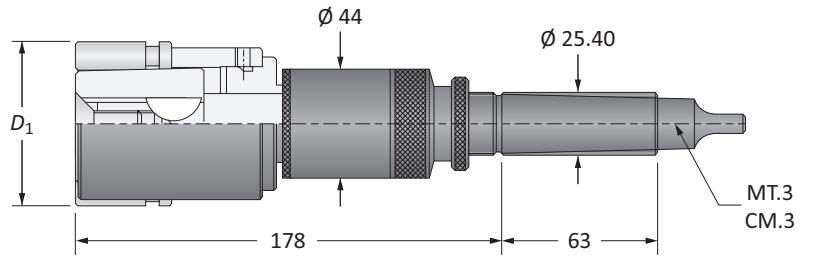

Blind Holes

D ₁		Part No.*		Spare Parts			Qty Rolls
Imperial (in)	Metric (mm)	Assembly with Morse Taper Shank	Assembly with Straight Shank	Cage	Cone**	Rolls	
2.2138 - 2.2551	56.23 - 57.28	RSKP-200-xxxxx	RSKP-100-xxxxx	RSCP-015-00142	RSTP-03x-00142	RSRY-708-00406	7
2.2461 - 2.2870	57.05 - 58.09	RSKP-200-xxxxx	RSKP-100-xxxxx	RSCP-015-00144	RSTP-03x-00144	RSRY-708-00406	7
2.2772 - 2.3177	57.84 - 58.87	RSKP-200-xxxxx	RSKP-100-xxxxx	RSCP-015-00146	RSTP-03x-00146	RSRY-708-00406	7
2.3079 - 2.3492	58.62 - 59.67	RSKP-200-xxxxx	RSKP-100-xxxxx	RSCP-015-00148	RSTP-03x-00148	RSRY-708-00406	7
2.3390 - 2.3799	59.41 - 60.45	RSKP-200-xxxxx	RSKP-100-xxxxx	RSCP-015-00150	RSTP-03x-00142	RSRY-708-00468	7
2.3713 - 2.4118	60.23 - 61.26	RSKP-200-xxxxx	RSKP-100-xxxxx	RSCP-015-00152	RSTP-03x-00144	RSRY-708-00468	7
2.4020 - 2.4433	61.01 - 62.06	RSKP-200-xxxxx	RSKP-100-xxxxx	RSCP-015-00154	RSTP-03x-00146	RSRY-708-00468	7
2.4330 - 2.4740	61.80 - 62.84	RSKP-200-xxxxx	RSKP-100-xxxxx	RSCP-015-00156	RSTP-03x-00148	RSRY-708-00468	7
2.4638 - 2.5051	62.58 - 63.63	RSKP-200-xxxxx	RSKP-100-xxxxx	RSCP-015-00158	RSTP-03x-00158	RSRY-708-00468	7
2.4961 - 2.5370	63.40 - 64.44	RSKP-200-xxxxx	RSKP-100-xxxxx	RSCP-015-00160	RSTP-03x-00160	RSRY-708-00468	7
2.5272 - 2.5677	64.19 - 65.22	RSKP-200-xxxxx	RSKP-100-xxxxx	RSCP-015-00162	RSTP-03x-00162	RSRY-708-00468	7
2.5579 - 2.5992	64.97 - 66.02	RSKP-200-xxxxx	RSKP-100-xxxxx	RSCP-015-00164	RSTP-03x-00164	RSRY-708-00468	7
2.5890 - 2.6299	65.76 - 66.80	RSKP-200-xxxxx	RSKP-100-xxxxx	RSCP-015-00166	RSTP-03x-00158	RSRY-708-00531	7
2.6213 - 2.6618	66.58 - 67.61	RSKP-200-xxxxx	RSKP-100-xxxxx	RSCP-015-00168	RSTP-03x-00160	RSRY-708-00531	7
2.6520 - 2.6933	67.36 - 68.41	RSKP-200-xxxxx	RSKP-100-xxxxx	RSCP-015-00170	RSTP-03x-00162	RSRY-708-00531	7
2.6830 - 2.7240	68.15 - 69.19	RSKP-200-xxxxx	RSKP-100-xxxxx	RSCP-015-00172	RSTP-03x-00164	RSRY-708-00531	7

*xxxxx = Indicate to 2 metric decimal places the size to be burnished (e.g. roller burnisher Ø 60.05mm with straight shank: RSKP-100-06005).

**x = A number that will vary from 2 to 8 depending upon the exact diameter to be burnished. See page D: 6 for the correct identification of the "x" value.

NOTE: Each roller burnishing tool comes assembled complete with cage, cone, and rolls.

Key on D: 1

D: 42 - 45

D: 40 - 41

D: 39

Roller Burnishing Tools | Through Holes

Q Series | Diameter Range: 2.7138" - 3.3492" (68.93mm - 85.07mm)

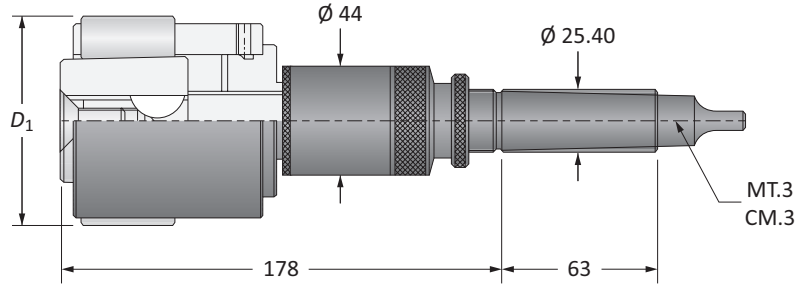

Through Holes

D ₁		Part No.		Spare Parts			
Imperial (in)	Metric (mm)	Assembly with Morse Taper Shank	Assembly with Straight Shank	Cage	Cone	Rolls	Qty Rolls
2.7138 - 2.7551	68.93 - 69.98	RDKQ-200-06893	RDKQ-100-06893	RDCQ-011-00174	RDTQ-031-00174	RDRY-701-00531	9
2.7461 - 2.7870	69.75 - 70.79	RDKQ-200-06975	RDKQ-100-06975	RDCQ-011-00176	RDTQ-031-00176	RDRY-701-00531	9
2.7772 - 2.8177	70.54 - 71.57	RDKQ-200-07054	RDKQ-100-07054	RDCQ-011-00178	RDTQ-031-00178	RDRY-701-00531	9
2.8079 - 2.8504	71.32 - 72.40	RDKQ-200-07132	RDKQ-100-07132	RDCQ-011-00180	RDTQ-031-00180	RDRY-701-00531	9
2.8390 - 2.8799	72.11 - 73.15	RDKQ-200-07211	RDKQ-100-07211	RDCQ-011-00182	RDTQ-031-00182	RDRY-701-00531	9
2.8713 - 2.9118	72.93 - 73.96	RDKQ-200-07293	RDKQ-100-07293	RDCQ-011-00184	RDTQ-031-00184	RDRY-701-00531	9
2.9020 - 2.9429	73.71 - 74.75	RDKQ-200-07371	RDKQ-100-07371	RDCQ-011-00186	RDTQ-031-00174	RDRY-701-00625	9
2.9331 - 2.9740	74.50 - 75.54	RDKQ-200-07450	RDKQ-100-07450	RDCQ-011-00188	RDTQ-031-00176	RDRY-701-00625	9
2.9638 - 3.0051	75.28 - 76.33	RDKQ-200-07528	RDKQ-100-07528	RDCQ-011-00190	RDTQ-031-00178	RDRY-701-00625	9
2.9961 - 3.0370	76.10 - 77.14	RDKQ-200-07610	RDKQ-100-07610	RDCQ-011-00192	RDTQ-031-00180	RDRY-701-00625	9
3.0272 - 3.0681	76.89 - 77.93	RDKQ-200-07689	RDKQ-100-07689	RDCQ-011-00194	RDTQ-031-00182	RDRY-701-00625	9
3.0579 - 3.0992	77.67 - 78.72	RDKQ-200-07767	RDKQ-100-07767	RDCQ-011-00196	RDTQ-031-00184	RDRY-701-00625	9
3.0890 - 3.1299	78.46 - 79.50	RDKQ-200-07846	RDKQ-100-07846	RDCQ-011-00198	RDTQ-031-00198	RDRY-701-00625	9
3.1209 - 3.1618	79.27 - 80.31	RDKQ-200-07927	RDKQ-100-07927	RDCQ-011-00200	RDTQ-031-00200	RDRY-701-00625	9
3.1520 - 3.1933	80.06 - 81.11	RDKQ-200-08006	RDKQ-100-08006	RDCQ-011-00202	RDTQ-031-00202	RDRY-701-00625	9
3.1831 - 3.2240	80.85 - 81.89	RDKQ-200-08085	RDKQ-100-08085	RDCQ-011-00204	RDTQ-031-00204	RDRY-701-00625	9
3.2138 - 3.2551	81.63 - 82.68	RDKQ-200-08163	RDKQ-100-08163	RDCQ-011-00206	RDTQ-031-00198	RDRY-701-00687	9
3.2461 - 3.2870	82.45 - 83.49	RDKQ-200-08245	RDKQ-100-08245	RDCQ-011-00208	RDTQ-031-00200	RDRY-701-00687	9
3.2772 - 3.3177	83.24 - 84.27	RDKQ-200-08324	RDKQ-100-08324	RDCQ-011-00210	RDTQ-031-00202	RDRY-701-00687	9
3.3079 - 3.3492	84.02 - 85.07	RDKQ-200-08402	RDKQ-100-08402	RDCQ-011-00212	RDTQ-031-00204	RDRY-701-00687	9

NOTE: Each roller burnishing tool comes assembled complete with cage, cone, and rolls.

Key on D: 1

D: 42 - 45

D: 40 - 41

D: 38



Roller Burnishing Tools | Blind Holes

Q Series | Diameter Range: 2.7138" - 3.3492" (68.93mm - 85.07mm)

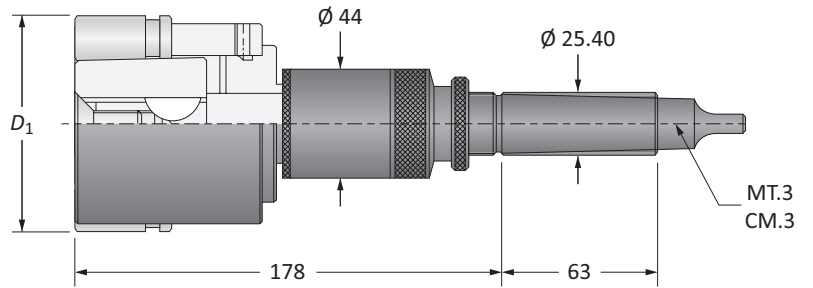

Blind Holes

D ₁		Part No.*		Spare Parts			Qty Rolls
Imperial (in)	Metric (mm)	Assembly with Morse Taper Shank	Assembly with Straight Shank	Cage	Cone**	Rolls	
2.7138 - 2.7551	68.93 - 69.98	RSKQ-200-xxxxx	RSKQ-100-xxxxx	RSCQ-015-00174	RSTQ-03x-00174	RSRY-708-00531	7
2.7461 - 2.7870	69.75 - 70.79	RSKQ-200-xxxxx	RSKQ-100-xxxxx	RSCQ-015-00176	RSTQ-03x-00176	RSRY-708-00531	7
2.7772 - 2.8177	70.54 - 71.57	RSKQ-200-xxxxx	RSKQ-100-xxxxx	RSCQ-015-00178	RSTQ-03x-00178	RSRY-708-00531	7
2.8079 - 2.8504	71.32 - 72.40	RSKQ-200-xxxxx	RSKQ-100-xxxxx	RSCQ-015-00180	RSTQ-03x-00180	RSRY-708-00531	7
2.8390 - 2.8799	72.11 - 73.15	RSKQ-200-xxxxx	RSKQ-100-xxxxx	RSCQ-015-00182	RSTQ-03x-00182	RSRY-708-00531	7
2.8713 - 2.9118	72.93 - 73.96	RSKQ-200-xxxxx	RSKQ-100-xxxxx	RSCQ-015-00184	RSTQ-03x-00184	RSRY-708-00531	7
2.9020 - 2.9429	73.71 - 74.75	RSKQ-200-xxxxx	RSKQ-100-xxxxx	RSCQ-015-00186	RSTQ-03x-00174	RSRY-708-00625	7
2.9331 - 2.9740	74.50 - 75.54	RSKQ-200-xxxxx	RSKQ-100-xxxxx	RSCQ-015-00188	RSTQ-03x-00176	RSRY-708-00625	7
2.9638 - 3.0051	75.28 - 76.33	RSKQ-200-xxxxx	RSKQ-100-xxxxx	RSCQ-015-00190	RSTQ-03x-00178	RSRY-708-00625	7
2.9961 - 3.0370	76.10 - 77.14	RSKQ-200-xxxxx	RSKQ-100-xxxxx	RSCQ-015-00192	RSTQ-03x-00180	RSRY-708-00625	7
3.0272 - 3.0681	76.89 - 77.93	RSKQ-200-xxxxx	RSKQ-100-xxxxx	RSCQ-015-00194	RSTQ-03x-00182	RSRY-708-00625	7
3.0579 - 3.0992	77.67 - 78.72	RSKQ-200-xxxxx	RSKQ-100-xxxxx	RSCQ-015-00196	RSTQ-03x-00184	RSRY-708-00625	7
3.0890 - 3.1299	78.46 - 79.50	RSKQ-200-xxxxx	RSKQ-100-xxxxx	RSCQ-015-00198	RSTQ-03x-00198	RSRY-708-00625	7
3.1209 - 3.1618	79.27 - 80.31	RSKQ-200-xxxxx	RSKQ-100-xxxxx	RSCQ-015-00200	RSTQ-03x-00200	RSRY-708-00625	7
3.1520 - 3.1933	80.06 - 81.11	RSKQ-200-xxxxx	RSKQ-100-xxxxx	RSCQ-015-00202	RSTQ-03x-00202	RSRY-708-00625	7
3.1831 - 3.2240	80.85 - 81.89	RSKQ-200-xxxxx	RSKQ-100-xxxxx	RSCQ-015-00204	RSTQ-03x-00204	RSRY-708-00625	7
3.2138 - 3.2551	81.63 - 82.68	RSKQ-200-xxxxx	RSKQ-100-xxxxx	RSCQ-015-00206	RSTQ-03x-00198	RSRY-708-00687	7
3.2461 - 3.2870	82.45 - 83.49	RSKQ-200-xxxxx	RSKQ-100-xxxxx	RSCQ-015-00208	RSTQ-03x-00200	RSRY-708-00687	7
3.2772 - 3.3177	83.24 - 84.27	RSKQ-200-xxxxx	RSKQ-100-xxxxx	RSCQ-015-00210	RSTQ-03x-00202	RSRY-708-00687	7
3.3079 - 3.3492	84.02 - 85.07	RSKQ-200-xxxxx	RSKQ-100-xxxxx	RSCQ-015-00212	RSTQ-03x-00204	RSRY-708-00687	7

*xxxxx = Indicate to 2 metric decimal places the size to be burnished (e.g. roller burnisher Ø 75.00mm with MT.3 shank: RSKQ-200-07500).

**x = A number that will vary from 2 to 8 depending upon the exact diameter to be burnished. See page D: 6 for the correct identification of the "x" value.

NOTE: Each roller burnishing tool comes assembled complete with cage, cone, and rolls.

Key on D: 1

D: 42 - 45

D: 40 - 41

D: 39

A DRILLING
 B BORING
 C REAMING
 D BURNISHING
 E THREADING
 X SPECIALS

Roller Burnishing Tools | Through Holes

R Series | Diameter Range: 3.3390 - 4.0992" (84.81mm - 104.12mm)

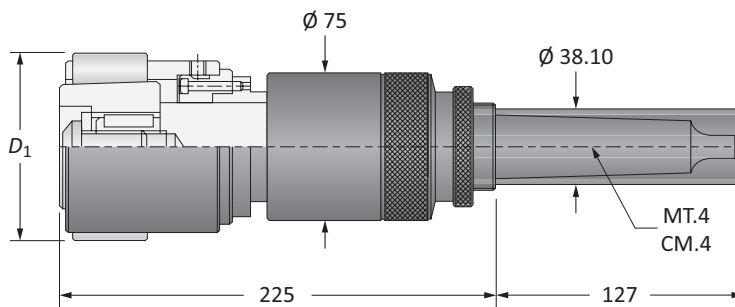

Through Holes

D_1		Part No.		Spare Parts			Qty Rolls
Imperial (in)	Metric (mm)	Assembly with Morse Taper Shank	Assembly with Straight Shank	Cage	Cone	Rolls	
3.3390 - 3.3799	84.81 - 85.85	RDKR-200-08481	RDKR-100-08481	RDCR-011-00214	RDTR-073-00001	RDRY-701-00468	9
3.3713 - 3.4118	85.63 - 86.66	RDKR-200-08563	RDKR-100-08563	RDCR-011-00216	RDTR-074-00001	RDRY-701-00468	9
3.4020 - 3.4429	86.41 - 87.45	RDKR-200-08641	RDKR-100-08641	RDCR-011-00218	RDTR-071-00001	RDRY-701-00531	9
3.4331 - 3.4740	87.20 - 88.24	RDKR-200-08720	RDKR-100-08720	RDCR-011-00220	RDTR-072-00001	RDRY-701-00531	9
3.4642 - 3.5051	87.99 - 89.03	RDKR-200-08799	RDKR-100-08799	RDCR-011-00222	RDTR-073-00001	RDRY-701-00531	9
3.4957 - 3.5370	88.79 - 89.84	RDKR-200-08879	RDKR-100-08879	RDCR-011-00224	RDTR-074-00001	RDRY-701-00531	9
3.5272 - 3.5681	89.59 - 90.63	RDKR-200-08959	RDKR-100-08959	RDCR-011-00226	RDTR-075-00001	RDRY-701-00531	9
3.5579 - 3.5992	90.37 - 91.42	RDKR-200-09037	RDKR-100-09037	RDCR-011-00228	RDTR-076-00001	RDRY-701-00531	9
3.5890 - 3.6299	91.16 - 92.20	RDKR-200-09116	RDKR-100-09116	RDCR-011-00230	RDTR-071-00001	RDRY-701-00625	9
3.6209 - 3.6622	91.97 - 93.02	RDKR-200-09197	RDKR-100-09197	RDCR-011-00232	RDTR-072-00001	RDRY-701-00625	9
3.6520 - 3.6929	92.76 - 93.80	RDKR-200-09276	RDKR-100-09276	RDCR-011-00234	RDTR-073-00001	RDRY-701-00625	9
3.6831 - 3.7240	93.55 - 94.59	RDKR-200-09355	RDKR-100-09355	RDCR-011-00236	RDTR-074-00001	RDRY-701-00625	9
3.7142 - 3.7551	94.34 - 95.38	RDKR-200-09434	RDKR-100-09434	RDCR-011-00238	RDTR-075-00001	RDRY-701-00625	9
3.7461 - 3.7870	95.15 - 96.19	RDKR-200-09515	RDKR-100-09515	RDCR-011-00240	RDTR-076-00001	RDRY-701-00625	9
3.7772 - 3.8181	95.94 - 96.98	RDKR-200-09594	RDKR-100-09594	RDCR-011-00242	RDTR-077-00001	RDRY-701-00625	9
3.8079 - 3.8492	96.72 - 97.77	RDKR-200-09672	RDKR-100-09672	RDCR-011-00244	RDTR-078-00001	RDRY-701-00625	9
3.8390 - 3.8799	97.51 - 98.55	RDKR-200-09751	RDKR-100-09751	RDCR-011-00246	RDTR-075-00001	RDRY-701-00687	9
3.8709 - 3.9122	98.32 - 99.37	RDKR-200-09832	RDKR-100-09832	RDCR-011-00248	RDTR-076-00001	RDRY-701-00687	9
3.9020 - 3.9429	99.11 - 100.15	RDKR-200-09911	RDKR-100-09911	RDCR-011-00250	RDTR-077-00001	RDRY-701-00687	9
3.9331 - 3.9740	99.90 - 100.94	RDKR-200-09990	RDKR-100-09990	RDCR-011-00252	RDTR-078-00001	RDRY-701-00687	9
3.9642 - 4.0051	100.69 - 101.73	RDKR-200-10069	RDKR-100-10069	RDCR-011-00254	RDTR-079-00001	RDRY-701-00687	9
3.9961 - 4.0370	101.50 - 102.54	RDKR-200-10150	RDKR-100-10150	RDCR-011-00256	RDTR-080-00001	RDRY-701-00687	9
4.0272 - 4.0681	102.29 - 103.33	RDKR-200-10229	RDKR-100-10229	RDCR-011-00258	RDTR-081-00001	RDRY-701-00687	9
4.0579 - 4.0992	103.07 - 104.12	RDKR-200-10307	RDKR-100-10307	RDCR-011-00260	RDTR-082-00001	RDRY-701-00687	9

NOTE: Each roller burnishing tool comes assembled complete with cage, cone, and rolls.

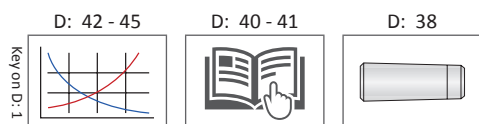



Roller Burnishing Tools | Blind Holes

R Series | Diameter Range: 3.3390 - 4.0992" (84.81mm - 104.12mm)

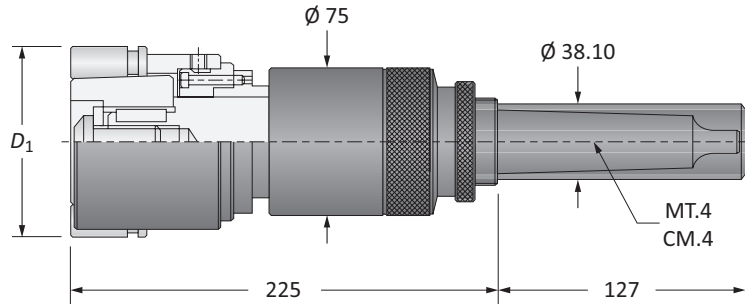

Blind Holes

D ₁		Part No.*		Spare Parts			Qty Rolls
Imperial (in)	Metric (mm)	Assembly with Morse Taper Shank	Assembly with Straight Shank	Cage	Cone**	Rolls	
3.3390 - 3.3799	84.81 - 85.85	RSKR-200-xxxxx	RSKR-100-xxxxx	RSCR-015-00214	RSTR-073-0000x	RSRY-708-00468	9
3.3713 - 3.4118	85.63 - 86.66	RSKR-200-xxxxx	RSKR-100-xxxxx	RSCR-015-00216	RSTR-074-0000x	RSRY-708-00468	9
3.4020 - 3.4429	86.41 - 87.45	RSKR-200-xxxxx	RSKR-100-xxxxx	RSCR-015-00218	RSTR-071-0000x	RSRY-708-00531	9
3.4331 - 3.4740	87.20 - 88.24	RSKR-200-xxxxx	RSKR-100-xxxxx	RSCR-015-00220	RSTR-072-0000x	RSRY-708-00531	9
3.4642 - 3.5051	87.99 - 89.03	RSKR-200-xxxxx	RSKR-100-xxxxx	RSCR-015-00222	RSTR-073-0000x	RSRY-708-00531	9
3.4957 - 3.5370	88.79 - 89.84	RSKR-200-xxxxx	RSKR-100-xxxxx	RSCR-015-00224	RSTR-074-0000x	RSRY-708-00531	9
3.5272 - 3.5681	89.59 - 90.63	RSKR-200-xxxxx	RSKR-100-xxxxx	RSCR-015-00226	RSTR-075-0000x	RSRY-708-00531	9
3.5579 - 3.5992	90.37 - 91.42	RSKR-200-xxxxx	RSKR-100-xxxxx	RSCR-015-00228	RSTR-076-0000x	RSRY-708-00531	9
3.5890 - 3.6299	91.16 - 92.20	RSKR-200-xxxxx	RSKR-100-xxxxx	RSCR-015-00230	RSTR-071-0000x	RSRY-708-00625	9
3.6209 - 3.6622	91.97 - 93.02	RSKR-200-xxxxx	RSKR-100-xxxxx	RSCR-015-00232	RSTR-072-0000x	RSRY-708-00625	9
3.6520 - 3.6929	92.76 - 93.80	RSKR-200-xxxxx	RSKR-100-xxxxx	RSCR-015-00234	RSTR-073-0000x	RSRY-708-00625	9
3.6831 - 3.7240	93.55 - 94.59	RSKR-200-xxxxx	RSKR-100-xxxxx	RSCR-015-00236	RSTR-074-0000x	RSRY-708-00625	9
3.7142 - 3.7551	94.34 - 95.38	RSKR-200-xxxxx	RSKR-100-xxxxx	RSCR-015-00238	RSTR-075-0000x	RSRY-708-00625	9
3.7461 - 3.7870	95.15 - 96.19	RSKR-200-xxxxx	RSKR-100-xxxxx	RSCR-015-00240	RSTR-076-0000x	RSRY-708-00625	9
3.7772 - 3.8181	95.94 - 96.98	RSKR-200-xxxxx	RSKR-100-xxxxx	RSCR-015-00242	RSTR-077-0000x	RSRY-708-00625	9
3.8079 - 3.8492	96.72 - 97.77	RSKR-200-xxxxx	RSKR-100-xxxxx	RSCR-015-00244	RSTR-078-0000x	RSRY-708-00625	9
3.8390 - 3.8799	97.51 - 98.55	RSKR-200-xxxxx	RSKR-100-xxxxx	RSCR-015-00246	RSTR-075-0000x	RSRY-708-00687	9
3.8709 - 3.9122	98.32 - 99.37	RSKR-200-xxxxx	RSKR-100-xxxxx	RSCR-015-00248	RSTR-076-0000x	RSRY-708-00687	9
3.9020 - 3.9429	99.11 - 100.15	RSKR-200-xxxxx	RSKR-100-xxxxx	RSCR-015-00250	RSTR-077-0000x	RSRY-708-00687	9
3.9331 - 3.9740	99.90 - 100.94	RSKR-200-xxxxx	RSKR-100-xxxxx	RSCR-015-00252	RSTR-078-0000x	RSRY-708-00687	9
3.9642 - 4.0051	100.69 - 101.73	RSKR-200-xxxxx	RSKR-100-xxxxx	RSCR-015-00254	RSTR-079-0000x	RSRY-708-00687	9
3.9961 - 4.0370	101.50 - 102.54	RSKR-200-xxxxx	RSKR-100-xxxxx	RSCR-015-00256	RSTR-080-0000x	RSRY-708-00687	9
4.0272 - 1.0681	102.29 - 103.33	RSKR-200-xxxxx	RSKR-100-xxxxx	RSCR-015-00258	RSTR-081-0000x	RSRY-708-00687	9
4.0579 - 4.0992	103.07 - 104.12	RSKR-200-xxxxx	RSKR-100-xxxxx	RSCR-015-00260	RSTR-082-0000x	RSRY-708-00687	9

*xxxxx = Indicate to 2 metric decimal places the size to be burnished (e.g. roller burnisher Ø 100.00mm with straight shank: RSKR-100-10000).

**x = A number that will vary from 2 to 8 depending upon the exact diameter to be burnished. See page D: 6 for the correct identification of the "x" value.

NOTE: Each roller burnishing tool comes assembled complete with cage, cone, and rolls.

D: 42 - 45 D: 40 - 41 D: 39

Roller Burnishing Tools | Through Holes

S Series | Diameter Range: 4.0890 - 5.0370" (103.86mm - 127.94mm)

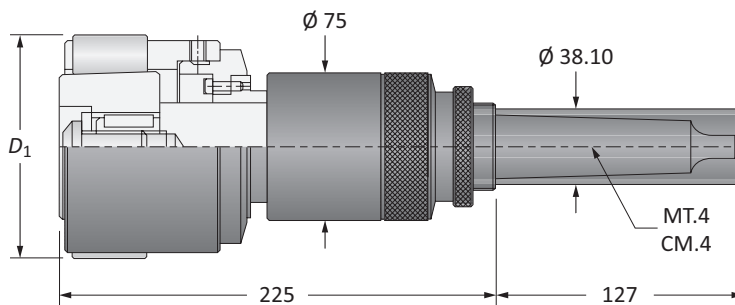

Through Holes

D_1		Part No.		Spare Parts			Qty Rolls
Imperial (in)	Metric (mm)	Assembly with Morse Taper Shank	Assembly with Straight Shank	Cage	Cone	Rolls	
4.0890 - 4.1299	103.86 - 104.90	RDKS-200-10386	RDKS-100-10386	RDCS-011-00262	RDTS-083-00001	RDRY-701-00687	9
4.1209 - 4.1634	104.67 - 105.75	RDKS-200-10467	RDKS-100-10467	RDCS-011-00264	RDTS-084-00001	RDRY-701-00687	9
4.1520 - 4.1929	105.46 - 106.50	RDKS-200-10546	RDKS-100-10546	RDCS-011-00266	RDTS-085-00001	RDRY-701-00687	9
4.1831 - 4.2240	106.25 - 107.29	RDKS-200-10625	RDKS-100-10625	RDCS-011-00268	RDTS-086-00001	RDRY-701-00687	9
4.2142 - 4.2551	107.04 - 108.08	RDKS-200-10704	RDKS-100-10704	RDCS-011-00270	RDTS-087-00001	RDRY-701-00687	9
4.2461 - 4.2870	107.85 - 108.89	RDKS-200-10785	RDKS-100-10785	RDCS-011-00272	RDTS-088-00001	RDRY-701-00687	9
4.2772 - 4.3181	108.64 - 109.68	RDKS-200-10864	RDKS-100-10864	RDCS-011-00274	RDTS-089-00001	RDRY-701-00687	9
4.3079 - 4.3492	109.42 - 110.47	RDKS-200-10942	RDKS-100-10942	RDCS-011-00276	RDTS-090-00001	RDRY-701-00687	9
4.3390 - 4.3799	110.21 - 111.25	RDKS-200-11021	RDKS-100-11021	RDCS-011-00278	RDTS-083-00001	RDRY-701-00812	9
4.3709 - 4.4122	111.02 - 112.07	RDKS-200-11102	RDKS-100-11102	RDCS-011-00280	RDTS-084-00001	RDRY-701-00812	9
4.4020 - 4.4429	111.81 - 112.85	RDKS-200-11181	RDKS-100-11181	RDCS-011-00282	RDTS-085-00001	RDRY-701-00812	9
4.4331 - 4.4740	112.60 - 113.64	RDKS-200-11260	RDKS-100-11260	RDCS-011-00284	RDTS-086-00001	RDRY-701-00812	9
4.4622 - 4.5051	113.34 - 114.43	RDKS-200-11334	RDKS-100-11334	RDCS-011-00286	RDTS-087-00001	RDRY-701-00812	9
4.4961 - 4.5370	114.20 - 115.24	RDKS-200-11420	RDKS-100-11420	RDCS-011-00288	RDTS-088-00001	RDRY-701-00812	9
4.5272 - 4.5681	114.99 - 116.03	RDKS-200-11499	RDKS-100-11499	RDCS-011-00290	RDTS-089-00001	RDRY-701-00812	9
4.5579 - 4.5992	115.77 - 116.82	RDKS-200-11577	RDKS-100-11577	RDCS-011-00292	RDTS-090-00001	RDRY-701-00812	9
4.5890 - 4.6299	116.56 - 117.60	RDKS-200-11656	RDKS-100-11656	RDCS-011-00294	RDTS-091-00001	RDRY-701-00812	9
4.6209 - 4.6622	117.37 - 118.42	RDKS-200-11737	RDKS-100-11737	RDCS-011-00296	RDTS-092-00001	RDRY-701-00812	9
4.6520 - 4.6929	118.16 - 119.20	RDKS-200-11816	RDKS-100-11816	RDCS-011-00298	RDTS-093-00001	RDRY-701-00812	9
4.6831 - 4.7240	118.95 - 119.99	RDKS-200-11895	RDKS-100-11895	RDCS-011-00300	RDTS-094-00001	RDRY-701-00812	9
4.7142 - 4.7551	119.74 - 120.78	RDKS-200-11974	RDKS-100-11974	RDCS-011-00302	RDTS-095-00001	RDRY-701-00812	9
4.7461 - 4.7870	120.55 - 121.59	RDKS-200-12055	RDKS-100-12055	RDCS-011-00304	RDTS-096-00001	RDRY-701-00812	9
4.7772 - 4.8181	121.34 - 122.38	RDKS-200-12134	RDKS-100-12134	RDCS-011-00306	RDTS-097-00001	RDRY-701-00812	9
4.8079 - 4.8492	122.12 - 123.17	RDKS-200-12212	RDKS-100-12212	RDCS-011-00308	RDTS-098-00001	RDRY-701-00812	9
4.8390 - 4.8799	122.91 - 123.95	RDKS-200-12291	RDKS-100-12291	RDCS-011-00310	RDTS-099-00001	RDRY-701-00812	9
4.8709 - 4.9122	123.72 - 124.77	RDKS-200-12372	RDKS-100-12372	RDCS-011-00312	RDTS-100-00001	RDRY-701-00812	9
4.9020 - 4.9429	124.51 - 125.55	RDKS-200-12451	RDKS-100-12451	RDCS-011-01245	RDTS-031-01245	RDRY-701-00812	9
4.9331 - 4.9740	125.30 - 126.34	RDKS-200-12530	RDKS-100-12530	RDCS-011-01255	RDTS-031-01255	RDRY-701-00812	9
4.9642 - 5.0051	126.09 - 127.13	RDKS-200-12609	RDKS-100-12609	RDCS-011-01265	RDTS-031-01265	RDRY-701-00812	9
4.9961 - 5.0370	126.90 - 127.94	RDKS-200-12690	RDKS-100-12690	RDCS-011-01275	RDTS-031-01275	RDRY-701-00812	9

NOTE: Each roller burnishing tool comes assembled complete with cage, cone, and rolls.

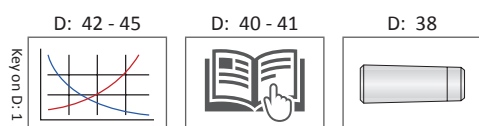



Roller Burnishing Tools | Blind Holes

S Series | Diameter Range: 4.0890 - 5.0370" (103.86mm - 127.94mm)

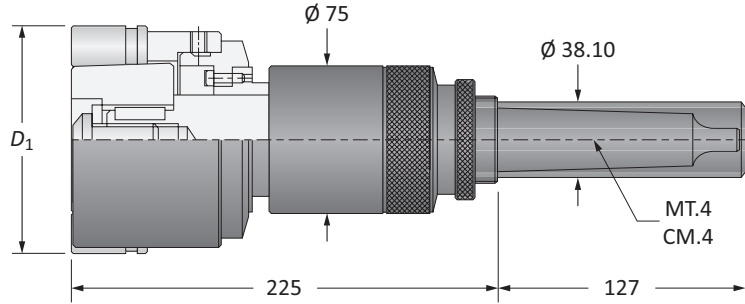

Blind Holes

D ₁		Part No.*		Spare Parts			Qty Rolls
Imperial (in)	Metric (mm)	Assembly with Morse Taper Shank	Assembly with Straight Shank	Cage	Cone**	Rolls	
4.0890 - 4.1299	103.86 - 104.90	RSKS-200-xxxxx	RSKS-100-xxxxx	RSCS-015-00262	RSTS-083-0000x	RSRY-708-00687	9
4.1209 - 4.1634	104.67 - 105.75	RSKS-200-xxxxx	RSKS-100-xxxxx	RSCS-015-00264	RSTS-084-0000x	RSRY-708-00687	9
4.1520 - 4.1929	105.46 - 106.50	RSKS-200-xxxxx	RSKS-100-xxxxx	RSCS-015-00266	RSTS-085-0000x	RSRY-708-00687	9
4.1831 - 4.2240	106.25 - 107.29	RSKS-200-xxxxx	RSKS-100-xxxxx	RSCS-015-00268	RSTS-086-0000x	RSRY-708-00687	9
4.2142 - 4.2551	107.04 - 108.08	RSKS-200-xxxxx	RSKS-100-xxxxx	RSCS-015-00270	RSTS-087-0000x	RSRY-708-00687	9
4.2461 - 4.2870	107.85 - 108.89	RSKS-200-xxxxx	RSKS-100-xxxxx	RSCS-015-00272	RSTS-088-0000x	RSRY-708-00687	9
4.2772 - 4.3181	108.64 - 109.68	RSKS-200-xxxxx	RSKS-100-xxxxx	RSCS-015-00274	RSTS-089-0000x	RSRY-708-00687	9
4.3079 - 4.3492	109.42 - 110.47	RSKS-200-xxxxx	RSKS-100-xxxxx	RSCS-015-00276	RSTS-090-0000x	RSRY-708-00687	9
4.3390 - 4.3799	110.21 - 111.25	RSKS-200-xxxxx	RSKS-100-xxxxx	RSCS-015-00278	RSTS-083-0000x	RSRY-708-00812	9
4.3709 - 4.4122	111.02 - 112.07	RSKS-200-xxxxx	RSKS-100-xxxxx	RSCS-015-00280	RSTS-084-0000x	RSRY-708-00812	9
4.4020 - 4.4429	111.81 - 112.85	RSKS-200-xxxxx	RSKS-100-xxxxx	RSCS-015-00282	RSTS-085-0000x	RSRY-708-00812	9
4.4331 - 4.4740	112.60 - 113.64	RSKS-200-xxxxx	RSKS-100-xxxxx	RSCS-015-00284	RSTS-086-0000x	RSRY-708-00812	9
4.4622 - 4.5051	113.34 - 114.43	RSKS-200-xxxxx	RSKS-100-xxxxx	RSCS-015-00286	RSTS-087-0000x	RSRY-708-00812	9
4.4961 - 4.5370	114.20 - 115.24	RSKS-200-xxxxx	RSKS-100-xxxxx	RSCS-015-00288	RSTS-088-0000x	RSRY-708-00812	9
4.5272 - 4.5681	114.99 - 116.03	RSKS-200-xxxxx	RSKS-100-xxxxx	RSCS-015-00290	RSTS-089-0000x	RSRY-708-00812	9
4.5579 - 4.5992	115.77 - 116.82	RSKS-200-xxxxx	RSKS-100-xxxxx	RSCS-015-00292	RSTS-090-0000x	RSRY-708-00812	9
4.5890 - 4.6299	116.56 - 117.60	RSKS-200-xxxxx	RSKS-100-xxxxx	RSCS-015-00294	RSTS-091-0000x	RSRY-708-00812	9
4.6209 - 4.6622	117.37 - 118.42	RSKS-200-xxxxx	RSKS-100-xxxxx	RSCS-015-00296	RSTS-092-0000x	RSRY-708-00812	9
4.6520 - 4.6929	118.16 - 119.20	RSKS-200-xxxxx	RSKS-100-xxxxx	RSCS-015-00298	RSTS-093-0000x	RSRY-708-00812	9
4.6831 - 4.7240	118.95 - 119.99	RSKS-200-xxxxx	RSKS-100-xxxxx	RSCS-015-00300	RSTS-094-0000x	RSRY-708-00812	9
4.7142 - 4.7551	119.74 - 120.78	RSKS-200-xxxxx	RSKS-100-xxxxx	RSCS-015-00302	RSTS-095-0000x	RSRY-708-00812	9
4.7461 - 4.7870	120.55 - 121.59	RSKS-200-xxxxx	RSKS-100-xxxxx	RSCS-015-00304	RSTS-096-0000x	RSRY-708-00812	9
4.7772 - 4.8181	121.34 - 122.38	RSKS-200-xxxxx	RSKS-100-xxxxx	RSCS-015-00306	RSTS-097-0000x	RSRY-708-00812	9
4.8079 - 4.8492	122.12 - 123.17	RSKS-200-xxxxx	RSKS-100-xxxxx	RSCS-015-00308	RSTS-098-0000x	RSRY-708-00812	9
4.8390 - 4.8799	122.91 - 123.95	RSKS-200-xxxxx	RSKS-100-xxxxx	RSCS-015-00310	RSTS-099-0000x	RSRY-708-00812	9
4.8709 - 4.9122	123.72 - 124.77	RSKS-200-xxxxx	RSKS-100-xxxxx	RSCS-015-00312	RSTS-100-0000x	RSRY-708-00812	9
4.9020 - 4.9429	124.51 - 125.55	RSKS-200-xxxxx	RSKS-100-xxxxx	RSCS-015-01245	RSTS-03x-01245	RSRY-708-00812	9
4.9331 - 4.9740	125.30 - 126.34	RSKS-200-xxxxx	RSKS-100-xxxxx	RSCS-015-01255	RSTS-03x-01255	RSRY-708-00812	9
4.9642 - 5.0051	126.09 - 127.13	RSKS-200-xxxxx	RSKS-100-xxxxx	RSCS-015-01265	RSTS-03x-01265	RSRY-708-00812	9
4.9961 - 5.0370	126.90 - 127.94	RSKS-200-xxxxx	RSKS-100-xxxxx	RSCS-015-01275	RSTS-03x-01275	RSRY-708-00812	9

*xxxxx = Indicate to 2 metric decimal places the size to be burnished (e.g. roller burnisher Ø 120.05mm with MT.4 shank: RSKS-200-12005).

**x = A number that will vary from 2 to 8 depending upon the exact diameter to be burnished. See page D: 6 for the correct identification of the "x" value.

NOTE: Each roller burnishing tool comes assembled complete with cage, cone, and rolls.

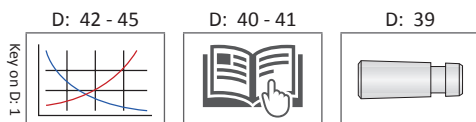

Roller Burnishing Tools | Through Holes

T Series | Diameter Range: 5.0354 - 5.9016" (127.90mm - 149.90mm)

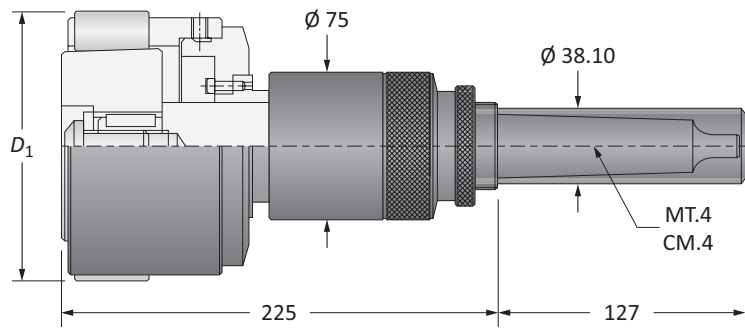

Through Holes

D_1		Part No.		Spare Parts			
Imperial (in)	Metric (mm)	Assembly with Morse Taper Shank	Assembly with Straight Shank	Cage	Cone	Rolls	Qty Rolls
5.0354 - 5.0748	127.90 - 128.90	RDKT-200-12790	RDKT-100-12790	RDCT-011-01280	RDTT-031-01280	RDRY-701-00812	11
5.0748 - 5.1142	128.90 - 129.90	RDKT-200-12890	RDKT-100-12890	RDCT-011-01290	RDTT-031-01290	RDRY-701-00812	11
5.1142 - 5.1535	129.90 - 130.90	RDKT-200-12990	RDKT-100-12990	RDCT-011-01300	RDTT-031-01300	RDRY-701-00812	11
5.1535 - 5.1929	130.90 - 131.90	RDKT-200-13090	RDKT-100-13090	RDCT-011-01310	RDTT-031-01310	RDRY-701-00812	11
5.1929 - 5.2323	131.90 - 132.90	RDKT-200-13190	RDKT-100-13190	RDCT-011-01320	RDTT-031-01320	RDRY-701-00812	11
5.2323 - 5.2717	132.90 - 133.90	RDKT-200-13290	RDKT-100-13290	RDCT-011-01330	RDTT-031-01330	RDRY-701-00812	11
5.2717 - 5.3110	133.90 - 134.90	RDKT-200-13390	RDKT-100-13390	RDCT-011-01340	RDTT-031-01340	RDRY-701-00812	11
5.3110 - 5.3504	134.90 - 135.90	RDKT-200-13490	RDKT-100-13490	RDCT-011-01350	RDTT-031-01350	RDRY-701-00812	11
5.3504 - 5.3898	135.90 - 136.90	RDKT-200-13590	RDKT-100-13590	RDCT-011-01360	RDTT-031-01360	RDRY-701-00812	11
5.3898 - 5.4291	136.90 - 137.90	RDKT-200-13690	RDKT-100-13690	RDCT-011-01370	RDTT-031-01370	RDRY-701-00812	11
5.4291 - 5.4685	137.90 - 138.90	RDKT-200-13790	RDKT-100-13790	RDCT-011-01380	RDTT-031-01380	RDRY-701-00812	11
5.4685 - 5.5079	138.90 - 139.90	RDKT-200-13890	RDKT-100-13890	RDCT-011-01390	RDTT-031-01390	RDRY-701-00812	11
5.5079 - 5.5472	139.90 - 140.90	RDKT-200-13990	RDKT-100-13990	RDCT-011-01400	RDTT-031-01400	RDRY-701-00812	11
5.5472 - 5.5866	140.90 - 141.90	RDKT-200-14090	RDKT-100-14090	RDCT-011-01410	RDTT-031-01410	RDRY-701-00812	11
5.5866 - 5.6260	141.60 - 142.90	RDKT-200-14190	RDKT-100-14190	RDCT-011-01420	RDTT-031-01420	RDRY-701-00812	11
5.6260 - 5.6654	142.90 - 143.90	RDKT-200-14290	RDKT-100-14290	RDCT-011-01430	RDTT-031-01430	RDRY-701-00812	11
5.6654 - 5.7047	143.90 - 144.90	RDKT-200-14390	RDKT-100-14390	RDCT-011-01440	RDTT-031-01440	RDRY-701-00812	11
5.7047 - 5.7441	144.90 - 145.90	RDKT-200-14490	RDKT-100-14490	RDCT-011-01450	RDTT-031-01450	RDRY-701-00812	11
5.7441 - 5.7835	145.90 - 146.90	RDKT-200-14590	RDKT-100-14590	RDCT-011-01460	RDTT-031-01460	RDRY-701-00812	11
5.7835 - 5.8228	146.90 - 147.90	RDKT-200-14690	RDKT-100-14690	RDCT-011-01470	RDTT-031-01470	RDRY-701-00812	11
5.8228 - 5.8622	147.90 - 148.90	RDKT-200-14790	RDKT-100-14790	RDCT-011-01480	RDTT-031-01480	RDRY-701-00812	11
5.8622 - 5.9016	148.90 - 149.90	RDKT-200-14890	RDKT-100-14890	RDCT-011-01490	RDTT-031-01490	RDRY-701-00812	11

NOTE: Each roller burnishing tool comes assembled complete with cage, cone, and rolls.

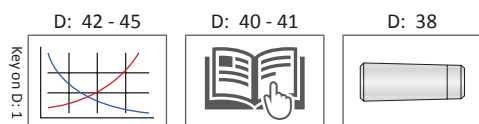



Roller Burnishing Tools | Blind Holes

T Series | Diameter Range: 5.0354 - 5.9016" (127.90mm - 149.90mm)

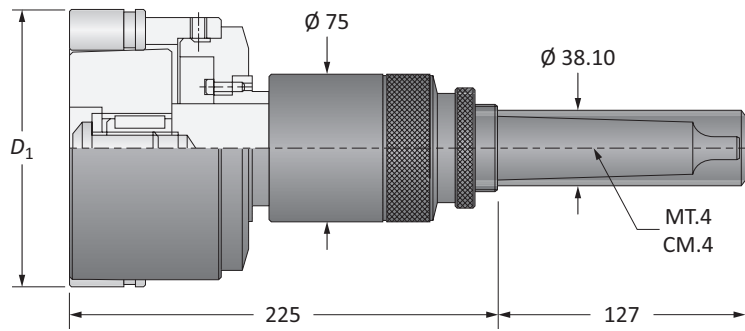

Blind Holes

D ₁		Part No.*		Spare Parts			Qty Rolls
Imperial (in)	Metric (mm)	Assembly with Morse Taper Shank	Assembly with Straight Shank	Cage	Cone**	Rolls	
5.0354 - 5.0748	127.90 - 128.90	RSKT-200-xxxxx	RSKT-100-xxxxx	RSCT-015-01280	RSTT-0xx-01280	RSRY-708-00812	11
5.0748 - 5.1142	128.90 - 129.90	RSKT-200-xxxxx	RSKT-100-xxxxx	RSCT-015-01290	RSTT-0xx-01290	RSRY-708-00812	11
5.1142 - 5.1535	129.90 - 130.90	RSKT-200-xxxxx	RSKT-100-xxxxx	RSCT-015-01300	RSTT-0xx-01300	RSRY-708-00812	11
5.1535 - 5.1929	130.90 - 131.90	RSKT-200-xxxxx	RSKT-100-xxxxx	RSCT-015-01310	RSTT-0xx-01310	RSRY-708-00812	11
5.1929 - 5.2323	131.90 - 132.90	RSKT-200-xxxxx	RSKT-100-xxxxx	RSCT-015-01320	RSTT-0xx-01320	RSRY-708-00812	11
5.2323 - 5.2717	132.90 - 133.90	RSKT-200-xxxxx	RSKT-100-xxxxx	RSCT-015-01330	RSTT-0xx-01330	RSRY-708-00812	11
5.2717 - 5.3110	133.90 - 134.90	RSKT-200-xxxxx	RSKT-100-xxxxx	RSCT-015-01340	RSTT-0xx-01340	RSRY-708-00812	11
5.3110 - 5.3504	134.90 - 135.90	RSKT-200-xxxxx	RSKT-100-xxxxx	RSCT-015-01350	RSTT-0xx-01350	RSRY-708-00812	11
5.3504 - 5.3898	135.90 - 136.90	RSKT-200-xxxxx	RSKT-100-xxxxx	RSCT-015-01360	RSTT-0xx-01360	RSRY-708-00812	11
5.3898 - 5.4291	136.90 - 137.90	RSKT-200-xxxxx	RSKT-100-xxxxx	RSCT-015-01370	RSTT-0xx-01370	RSRY-708-00812	11
5.4291 - 5.4685	137.90 - 138.90	RSKT-200-xxxxx	RSKT-100-xxxxx	RSCT-015-01380	RSTT-0xx-01380	RSRY-708-00812	11
5.4685 - 5.5079	138.90 - 139.90	RSKT-200-xxxxx	RSKT-100-xxxxx	RSCT-015-01390	RSTT-0xx-01390	RSRY-708-00812	11
5.5079 - 5.5472	139.90 - 140.90	RSKT-200-xxxxx	RSKT-100-xxxxx	RSCT-015-01400	RSTT-0xx-01400	RSRY-708-00812	11
5.5472 - 5.5866	140.90 - 141.90	RSKT-200-xxxxx	RSKT-100-xxxxx	RSCT-015-01410	RSTT-0xx-01410	RSRY-708-00812	11
5.5866 - 5.6260	141.60 - 142.90	RSKT-200-xxxxx	RSKT-100-xxxxx	RSCT-015-01420	RSTT-0xx-01420	RSRY-708-00812	11
5.6260 - 5.6654	142.90 - 143.90	RSKT-200-xxxxx	RSKT-100-xxxxx	RSCT-015-01430	RSTT-0xx-01430	RSRY-708-00812	11
5.6654 - 5.7047	143.90 - 144.90	RSKT-200-xxxxx	RSKT-100-xxxxx	RSCT-015-01440	RSTT-0xx-01440	RSRY-708-00812	11
5.7047 - 5.7441	144.90 - 145.90	RSKT-200-xxxxx	RSKT-100-xxxxx	RSCT-015-01450	RSTT-0xx-01450	RSRY-708-00812	11
5.7441 - 5.7835	145.90 - 146.90	RSKT-200-xxxxx	RSKT-100-xxxxx	RSCT-015-01460	RSTT-0xx-01460	RSRY-708-00812	11
5.7835 - 5.8228	146.90 - 147.90	RSKT-200-xxxxx	RSKT-100-xxxxx	RSCT-015-01470	RSTT-0xx-01470	RSRY-708-00812	11
5.8228 - 5.8622	147.90 - 148.90	RSKT-200-xxxxx	RSKT-100-xxxxx	RSCT-015-01480	RSTT-0xx-01480	RSRY-708-00812	11
5.8622 - 5.9016	148.90 - 149.90	RSKT-200-xxxxx	RSKT-100-xxxxx	RSCT-015-01490	RSTT-0xx-01490	RSRY-708-00812	11

*xxxxx = Indicate to 2 metric decimal places the size to be burnished (e.g. roller burnisher Ø 140.00mm with straight shank: RSKT-100-14000).

**x = A number that will vary from 2 to 8 depending upon the exact diameter to be burnished. See page D: 6 for the correct identification of the "x" value.

NOTE: Each roller burnishing tool comes assembled complete with cage, cone, and rolls.

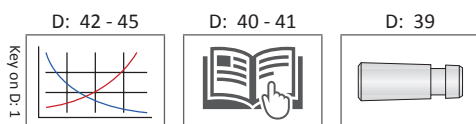

T
A
DRILLING
B
BORING
C
REAMING
D
BURNISHING
E
THREADING
X
SPECIALS

U



 BURNISHING | S.C.A.M.I.® Roller Burnishing Systems

A

Roller Burnishing Tools | Through Holes

U Series | Diameter Range: 5.9016" - 6.5315" (149.90mm - 165.90mm)

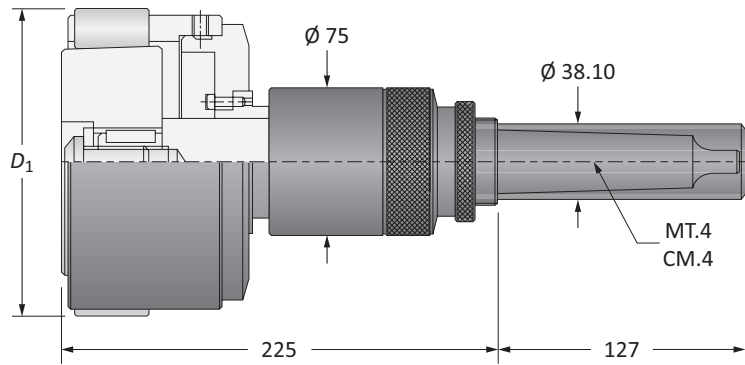
DRILLING

Technical drawing showing dimensions: $\varnothing 75$, $\varnothing 38.10$, MT.4 CM.4, 225, 127, and D_1 .

B

BORING

Through Holes

D_1		Part No.		Spare Parts				Qty Rolls
Imperial (in)	Metric (mm)	Assembly with Morse Taper Shank	Assembly with Straight Shank	Cage	Cone	Rolls		
5.9016 - 5.9409	149.90 - 150.90	RDKU-200-14990	RDKU-100-14990	RDCU-011-01500	RDTU-031-01500	RDRY-701-00812	13	
5.9409 - 5.9803	150.90 - 151.90	RDKU-200-15090	RDKU-100-15090	RDCU-011-01510	RDTU-031-01510	RDRY-701-00812	13	
5.9803 - 6.0197	151.90 - 152.90	RDKU-200-15190	RDKU-100-15190	RDCU-011-01520	RDTU-031-01520	RDRY-701-00812	13	
6.0197 - 6.0591	152.90 - 153.90	RDKU-200-15290	RDKU-100-15290	RDCU-011-01530	RDTU-031-01530	RDRY-701-00812	13	
6.0591 - 6.0984	153.90 - 154.90	RDKU-200-15390	RDKU-100-15390	RDCU-011-01540	RDTU-031-01540	RDRY-701-00812	13	
6.0984 - 6.1378	154.90 - 155.90	RDKU-200-15490	RDKU-100-15490	RDCU-011-01550	RDTU-031-01550	RDRY-701-00812	13	
6.1378 - 6.1772	155.90 - 156.90	RDKU-200-15590	RDKU-100-15590	RDCU-011-01560	RDTU-031-01560	RDRY-701-00812	13	
6.1772 - 6.2165	156.90 - 157.90	RDKU-200-15690	RDKU-100-15690	RDCU-011-01570	RDTU-031-01570	RDRY-701-00812	13	
6.2165 - 6.2559	157.90 - 158.90	RDKU-200-15790	RDKU-100-15790	RDCU-011-01580	RDTU-031-01580	RDRY-701-00812	13	
6.2559 - 6.2953	158.90 - 159.90	RDKU-200-15890	RDKU-100-15890	RDCU-011-01590	RDTU-031-01590	RDRY-701-00812	13	
6.2953 - 6.3346	159.90 - 160.90	RDKU-200-15990	RDKU-100-15990	RDCU-011-01600	RDTU-031-01600	RDRY-701-00812	13	
6.3346 - 6.3740	160.90 - 161.90	RDKU-200-16090	RDKU-100-16090	RDCU-011-01610	RDTU-031-01610	RDRY-701-00812	13	
6.3740 - 6.4134	161.90 - 162.90	RDKU-200-16190	RDKU-100-16190	RDCU-011-01620	RDTU-031-01620	RDRY-701-00812	13	
6.4134 - 6.4528	162.90 - 163.90	RDKU-200-16290	RDKU-100-16290	RDCU-011-01630	RDTU-031-01630	RDRY-701-00812	13	
6.4528 - 6.4921	163.90 - 164.90	RDKU-200-16390	RDKU-100-16390	RDCU-011-01640	RDTU-031-01640	RDRY-701-00812	13	
6.4921 - 6.5315	164.90 - 165.90	RDKU-200-16490	RDKU-100-16490	RDCU-011-01650	RDTU-031-01650	RDRY-701-00812	13	

NOTE: Each roller burnishing tool comes assembled complete with cage, cone, and rolls.

C

REAMING

D

BURNISHING



E

THREADING

X

SPECIALS

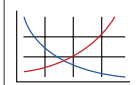
Key on D: 1

D: 42 - 45  D: 40 - 41  D: 38 

D: 36

www.alliedmachine.com | 1.330.343.4283



Roller Burnishing Tools | Blind Holes

U Series | Diameter Range: 5.9016" - 6.5315" (149.90mm - 165.90mm)

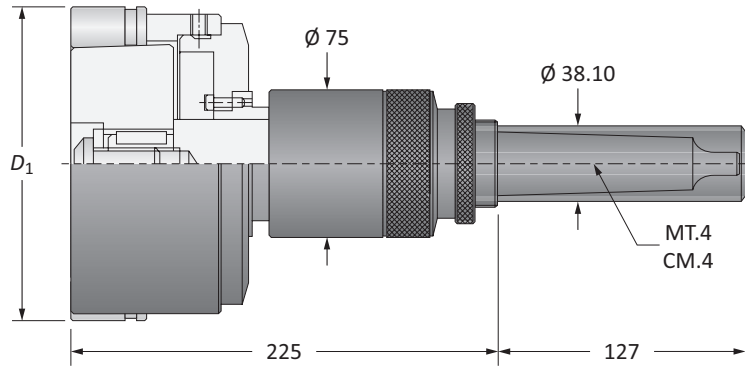

Blind Holes

D ₁		Part No.*		Spare Parts			Qty Rolls
Imperial (in)	Metric (mm)	Assembly with Morse Taper Shank	Assembly with Straight Shank	Cage	Cone**	Rolls	
5.9016 - 5.9409	149.90 - 150.90	RSKU-200-xxxxx	RSKU-100-xxxxx	RSCU-015-01500	RSTU-0xx-01500	RSRY-708-00812	13
5.9409 - 5.9803	150.90 - 151.90	RSKU-200-xxxxx	RSKU-100-xxxxx	RSCU-015-01510	RSTU-0xx-01510	RSRY-708-00812	13
5.9803 - 6.0197	151.90 - 152.90	RSKU-200-xxxxx	RSKU-100-xxxxx	RSCU-015-01520	RSTU-0xx-01520	RSRY-708-00812	13
6.0197 - 6.0591	152.90 - 153.90	RSKU-200-xxxxx	RSKU-100-xxxxx	RSCU-015-01530	RSTU-0xx-01530	RSRY-708-00812	13
6.0591 - 6.0984	153.90 - 154.90	RSKU-200-xxxxx	RSKU-100-xxxxx	RSCU-015-01540	RSTU-0xx-01540	RSRY-708-00812	13
6.0984 - 6.1378	154.90 - 155.90	RSKU-200-xxxxx	RSKU-100-xxxxx	RSCU-015-01550	RSTU-0xx-01550	RSRY-708-00812	13
6.1378 - 6.1772	155.90 - 156.90	RSKU-200-xxxxx	RSKU-100-xxxxx	RSCU-015-01560	RSTU-0xx-01560	RSRY-708-00812	13
6.1772 - 6.2165	156.90 - 157.90	RSKU-200-xxxxx	RSKU-100-xxxxx	RSCU-015-01570	RSTU-0xx-01570	RSRY-708-00812	13
6.2165 - 6.2559	157.90 - 158.90	RSKU-200-xxxxx	RSKU-100-xxxxx	RSCU-015-01580	RSTU-0xx-01580	RSRY-708-00812	13
6.2559 - 6.2953	158.90 - 159.90	RSKU-200-xxxxx	RSKU-100-xxxxx	RSCU-015-01590	RSTU-0xx-01590	RSRY-708-00812	13
6.2953 - 6.3346	159.90 - 160.90	RSKU-200-xxxxx	RSKU-100-xxxxx	RSCU-015-01600	RSTU-0xx-01600	RSRY-708-00812	13
6.3346 - 6.3740	160.90 - 161.90	RSKU-200-xxxxx	RSKU-100-xxxxx	RSCU-015-01610	RSTU-0xx-01610	RSRY-708-00812	13
6.3740 - 6.4134	161.90 - 162.90	RSKU-200-xxxxx	RSKU-100-xxxxx	RSCU-015-01620	RSTU-0xx-01620	RSRY-708-00812	13
6.4134 - 6.4528	162.90 - 163.90	RSKU-200-xxxxx	RSKU-100-xxxxx	RSCU-015-01630	RSTU-0xx-01630	RSRY-708-00812	13
6.4528 - 6.4921	163.90 - 164.90	RSKU-200-xxxxx	RSKU-100-xxxxx	RSCU-015-01640	RSTU-0xx-01640	RSRY-708-00812	13
6.4921 - 6.5315	164.90 - 165.90	RSKU-200-xxxxx	RSKU-100-xxxxx	RSCU-015-01650	RSTU-0xx-01650	RSRY-708-00812	13

*xxxxx = Indicate to 2 metric decimal places the size to be burnished (e.g. roller burnisher Ø 160.00mm with MT.4 shank: RSKU-200-16000).

**x = A number that will vary from 2 to 8 depending upon the exact diameter to be burnished. See page D: 6 for the correct identification of the "x" value.

NOTE: Each roller burnishing tool comes assembled complete with cage, cone, and rolls.

Key on D: 1

D: 42 - 45

D: 40 - 41

D: 39

U
A
DRILLING
B
BORING
C
REAMING
D
BURNISHING
E
THREADING
X
SPECIALS

Rolls

Through Holes

Rolls 704 and 707

Part No.	Imperial (in)		Metric (mm)	
	D	L	D	L
RDRY-704-00047	0.0465	0.2500	1.18	6.35
RDRY-704-00062	0.0618	0.2500	1.57	6.35
RDRY-704-00070	0.0697	0.3126	1.77	7.94
RDRY-704-00078	0.0776	0.3752	1.97	9.53
RDRY-704-00086	0.0854	0.3752	2.17	9.53
RDRY-704-00093	0.0929	0.3752	2.36	9.53
RDRY-704-00109	0.1083	0.5000	2.75	12.70
RDRY-704-00125	0.1244	0.5000	3.16	12.70
RDRY-704-00148	0.1472	0.5000	3.74	12.70
RDRY-704-00156	0.1555	0.5000	3.95	12.70
RDRY-704-00172	0.1709	0.6252	4.34	15.88
RDRY-704-00187	0.1858	0.8772	4.72	22.28
RDRY-707-00187	0.1870	0.5000	4.75	12.70
RDRY-704-00218	0.2173	0.5000	5.52	12.70
RDRY-707-00218	0.2173	1.0000	5.52	25.40
RDRY-704-00265	0.2638	1.1252	6.70	28.58
RDRY-704-00312	0.3110	1.5000	7.90	38.10
RDRY-707-00312	0.3118	1.1252	7.92	28.58
RDRY-704-00406	0.4047	1.5000	10.28	38.10
RDRY-704-00468	0.4669	1.5000	11.86	38.10
RDRY-704-00531	0.5299	1.5000	13.46	38.10
RDRY-704-00625	0.6240	1.5000	15.85	38.10
RDRY-704-00687	0.6858	1.5000	17.42	38.10
RDRY-704-00812	0.8110	1.5000	20.60	38.10

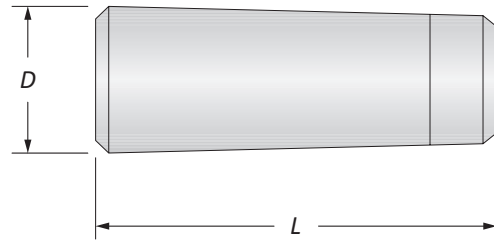

Rolls 701

Part No.	Imperial (in)		Metric (mm)	
	D	L	D	L
RDRY-701-00187	0.1831	0.8772	4.65	22.28
RDRY-701-00218	0.2138	1.0000	5.43	25.40
RDRY-701-00265	0.2610	1.1252	6.63	28.58
RDRY-701-00312	0.3039	1.5000	7.72	38.10
RDRY-701-00406	0.3980	1.5000	10.11	38.10
RDRY-701-00468	0.4598	1.5000	11.68	38.10
RDRY-701-00531	0.5228	1.5000	13.28	38.10
RDRY-701-00625	0.6169	1.5000	15.67	38.10
RDRY-701-00687	0.6799	1.5000	17.27	38.10
RDRY-701-00812	0.8039	1.5000	20.42	38.10

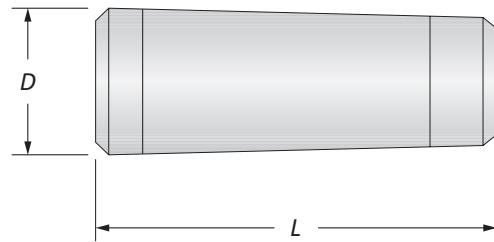

Rolls

Blind Holes

Rolls 708

Part No.	Imperial (in)		Metric (mm)	
	<i>D</i>	<i>L</i>	<i>D</i>	<i>L</i>
RSRY-708-00086	0.0854	0.3752	2.17	9.53
RSRY-708-00125	0.1244	0.5000	3.16	12.70
RSRY-708-00156	0.1555	0.5000	3.95	12.70
RSRY-708-00172	0.1709	0.6252	4.35	15.88
RSRY-708-00187	0.1858	0.8772	4.72	22.28
RSRY-708-00218	0.2173	0.5000	5.52	25.40
RSRY-708-00265	0.2638	1.1252	6.70	28.58
RSRY-708-00312	0.3110	1.5000	7.90	38.10
RSRY-708-00406	0.4047	1.5000	10.29	38.10
RSRY-708-00468	0.4669	1.5000	11.86	38.10
RSRY-708-00531	0.5299	1.5000	13.46	38.10
RSRY-708-00625	0.6240	1.5000	15.85	38.10
RSRY-708-00687	0.6858	1.5000	17.42	38.10
RSRY-708-00812	0.8110	1.5000	20.60	38.10

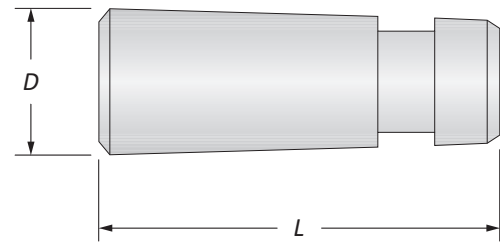

A

DRILLING

B

BORING

C

REAMING

D

BURNISHING

E

THREADING

X

SPECIALS

Diameter Adjustment

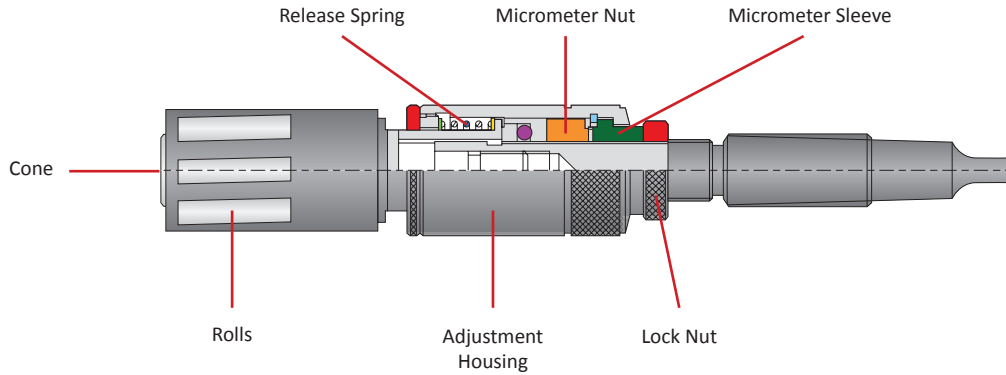

Adjustment

The roller burnishing tool incorporates a shank, a body, and a planetary system of conical rolls that are evenly spaced by a retaining cage.

1. Unscrew the lock nut.
2. Pull the housing toward the lock nut and rotate to increase or decrease the diameter.
3. Tighten the lock nut.

IMPORTANT: As you increase the diameter, the cone moves forward, pushing the rolls outward. Because of this, the cone will protrude from the end of the cage, decreasing the clearance available in blind holes (see Figures 1 and 2).

Refer to chart below for clearance values.

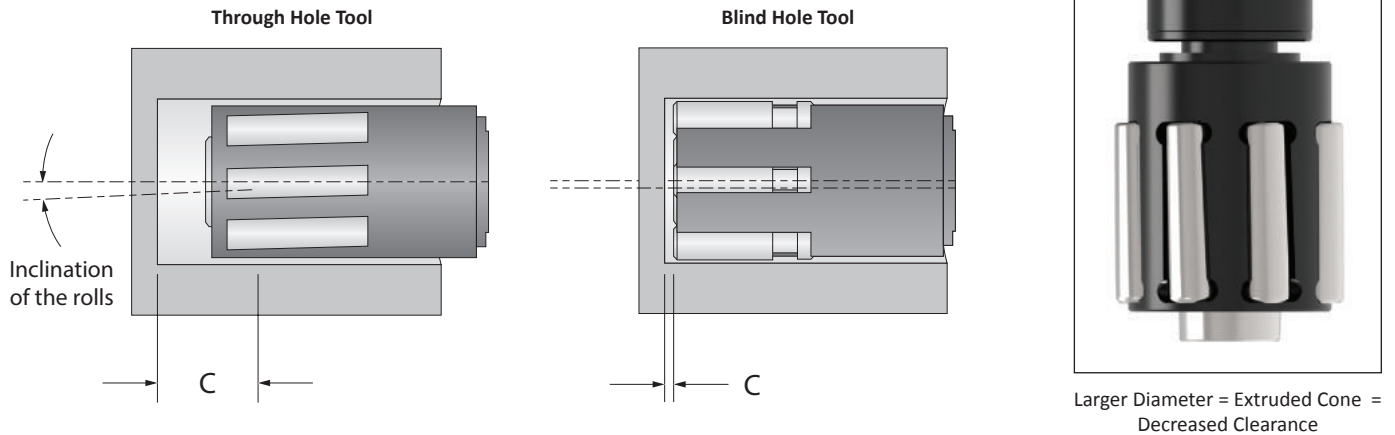

Adjustment Range		Clearance (C)		
		Through Holes		Blind Holes
Imperial (inch)	Metric (mm)	Rolls 701	Rolls 704 / 707	Rolls 708
0.1850 - 0.2315	4.70 - 5.88	–	2.40	–
0.2319 - 0.3728	5.89 - 9.47	–	2.40	0.60
0.3732 - 0.6236	9.48 - 15.84	–	2.40	0.60
0.6240 - 1.1236	15.85 - 28.54	5.40	3.20	1.00
1.1240 - 1.8385	28.55 - 46.70	9.50	3.20	1.00
1.8390 - 3.3386	46.71 - 84.80	9.50	4.00	1.00
3.3390 - 6.5315	84.81 - 165.90	10.30	4.70	1.00

A DRILLING
 B BORING
 C REAMING
 D BURNISHING
 E THREADING
 X SPECIALS

How it Works

Roller Burnishing Tools

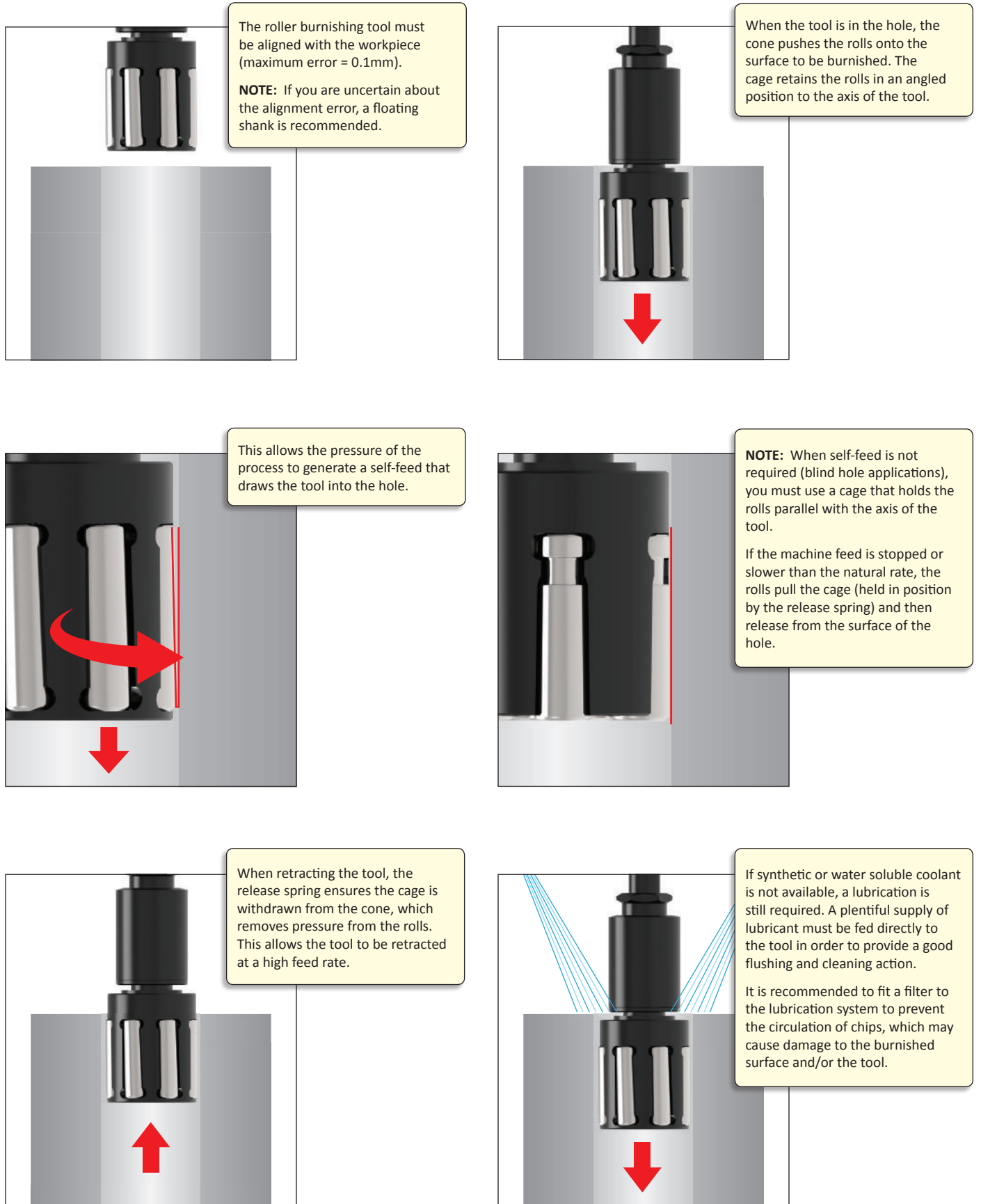

Recommended Cutting Data | Imperial (inch)

Roller Burnishing

ISO	Material	Hardness (BHN)	Speed (SFM)	Recommended Feed (IPR) by Burnisher Diameter			
				0.1850 - 0.4724	0.4725 - 0.9843	0.9844 - 1.9685	1.9686 - 6.5315
P	Free Machining Steel 1118, 1215, 12L14, etc.	100 - 180	75 - 300	0.005 - 0.020	0.014 - 0.037	0.032 - 0.086	0.070 - 0.121
		180 - 250	75 - 300	0.005 - 0.020	0.014 - 0.037	0.032 - 0.086	0.070 - 0.121
	Low Carbon Steel 1010, 1020, 1025, 1522, 1144, etc.	85 - 180	75 - 300	0.005 - 0.020	0.014 - 0.037	0.032 - 0.086	0.070 - 0.121
		180 - 275	75 - 300	0.005 - 0.020	0.014 - 0.037	0.032 - 0.086	0.070 - 0.121
	Medium Carbon Steel 1030, 1040, 1050, 1527, 1140, 1151, etc.	125 - 180	75 - 300	0.005 - 0.020	0.014 - 0.037	0.032 - 0.086	0.070 - 0.121
		180 - 325	75 - 300	0.005 - 0.020	0.014 - 0.037	0.032 - 0.086	0.070 - 0.121
	Alloy Steel 4140, 5140, 8640, etc.	125 - 180	75 - 300	0.005 - 0.020	0.014 - 0.037	0.032 - 0.086	0.070 - 0.121
		180 - 375	75 - 300	0.005 - 0.020	0.014 - 0.037	0.032 - 0.086	0.070 - 0.121
	High Strength Alloy 4340, 4330V, 300M, etc.	240 - 450	75 - 300	0.005 - 0.020	0.014 - 0.037	0.032 - 0.086	0.070 - 0.121
Structural Steel A36, A285, A516, etc.	125 - 180	75 - 300	0.005 - 0.020	0.014 - 0.037	0.032 - 0.086	0.070 - 0.121	
	180 - 350	75 - 300	0.005 - 0.020	0.014 - 0.037	0.032 - 0.086	0.070 - 0.121	
Tool Steel H-13, H-21, A-4, O-2, S-3, etc.	150 - 200	75 - 300	0.005 - 0.020	0.014 - 0.037	0.032 - 0.086	0.070 - 0.121	
	200 - 250	75 - 300	0.005 - 0.020	0.014 - 0.037	0.032 - 0.086	0.070 - 0.121	
S	High Temp Alloy Hastelloy B, Inconel 600, etc.	140 - 310	50 - 150	0.005 - 0.020	0.014 - 0.037	0.032 - 0.086	0.070 - 0.121
M	Titanium Alloy	140 - 310	50 - 150	0.005 - 0.020	0.014 - 0.037	0.032 - 0.086	0.070 - 0.121
M	Stainless Steel 400 Series 416, 420, etc.	135 - 350	75 - 200	0.005 - 0.020	0.014 - 0.037	0.032 - 0.086	0.070 - 0.121
M	Stainless Steel 300 Series 304, 316, 17-4PH, etc.	135 - 275	75 - 200	0.005 - 0.020	0.014 - 0.037	0.032 - 0.086	0.070 - 0.121
K	Grey Cast Iron, Ductile Iron, Spheroidal Cast Iron (Pearlitic) Spheroidal Cast Iron (Ferritic)	< 200	75 - 300	0.005 - 0.020	0.014 - 0.037	0.032 - 0.086	0.070 - 0.121
		> 200	75 - 300	0.005 - 0.020	0.014 - 0.037	0.032 - 0.086	0.070 - 0.121
		260 - 320	75 - 300	0.005 - 0.020	0.014 - 0.037	0.032 - 0.086	0.070 - 0.121
N	Copper and Alloys Brass	< 500	150 - 350	0.005 - 0.020	0.014 - 0.037	0.032 - 0.086	0.070 - 0.121
	Bronze Bronze Phosphorous Aluminum and Alloys	< 180	150 - 350	0.005 - 0.020	0.014 - 0.037	0.032 - 0.086	0.070 - 0.121
		< 150	150 - 350	0.005 - 0.020	0.014 - 0.037	0.032 - 0.086	0.070 - 0.121

Max RPM

Series	Max RPM
H	2000
I	1500
K	1200
L	1000
F	1000
M	900
N	900
O	700
P	600
Q	500
R	300
S	300
T	250
U	200

IMPORTANT: The speeds and feeds listed on these pages are a general starting point for all applications. Factory technical assistance is available through our Application Engineering department.

Stock Allowance | Imperial (inch)

Roller Burnishing

ISO	Material	Hardness (BHN)	Recommended Stock (inch) by Burnisher Diameter*			
			0.1850 - 0.4724	0.4725 - 0.9843	0.9844 - 1.9685	1.9686 - 6.5315
P	Free Machining Steel 1118, 1215, 12L14, etc.	100 - 180	0.0004 - 0.0007	0.0007 - 0.0016	0.0010 - 0.0018	0.0012 - 0.0020
		180 - 250	0.0004 - 0.0007	0.0007 - 0.0016	0.0010 - 0.0018	0.0012 - 0.0020
	Low Carbon Steel 1010, 1020, 1025, 1522, 1144, etc.	85 - 180	0.0004 - 0.0007	0.0007 - 0.0016	0.0010 - 0.0018	0.0012 - 0.0020
		180 - 275	0.0004 - 0.0007	0.0007 - 0.0016	0.0010 - 0.0018	0.0012 - 0.0020
	Medium Carbon Steel 1030, 1040, 1050, 1527, 1140, 1151, etc.	125 - 180	0.0004 - 0.0007	0.0007 - 0.0016	0.0010 - 0.0018	0.0012 - 0.0020
		180 - 325	0.0004 - 0.0007	0.0005 - 0.0007	0.0005 - 0.0010	0.0008 - 0.0014
	Alloy Steel 4140, 5140, 8640, etc.	125 - 180	0.0004 - 0.0007	0.0007 - 0.0016	0.0010 - 0.0018	0.0012 - 0.0020
		180 - 375	0.0004 - 0.0007	0.0005 - 0.0007	0.0005 - 0.0010	0.0008 - 0.0014
	High Strength Alloy 4340, 4330V, 300M, etc.	240 - 450	0.0004 - 0.0007	0.0005 - 0.0007	0.0005 - 0.0010	0.0008 - 0.0014
	Structural Steel A36, A285, A516, etc.	125 - 180	0.0004 - 0.0007	0.0007 - 0.0016	0.0010 - 0.0018	0.0012 - 0.0020
	180 - 350	0.0004 - 0.0007	0.0005 - 0.0007	0.0005 - 0.0010	0.0008 - 0.0014	
Tool Steel H-13, H-21, A-4, O-2, S-3, etc.	150 - 200	0.0004 - 0.0007	0.0007 - 0.0016	0.0010 - 0.0018	0.0012 - 0.0020	
	200 - 250	0.0004 - 0.0007	0.0005 - 0.0007	0.0005 - 0.0010	0.0008 - 0.0014	
S	High Temp Alloy Hastelloy B, Inconel 600, etc.	140 - 310	0.0004 - 0.0007	0.0005 - 0.0007	0.0005 - 0.0010	0.0008 - 0.0014
	Titanium Alloy	140 - 310	0.0004 - 0.0007	0.0005 - 0.0007	0.0005 - 0.0010	0.0008 - 0.0014
M	Stainless Steel 400 Series 416, 420, etc.	135 - 350	0.0004 - 0.0007	0.0007 - 0.0016	0.0010 - 0.0018	0.0012 - 0.0020
	Stainless Steel 300 Series 304, 316, 17-4PH, etc.	135 - 275	0.0004 - 0.0007	0.0007 - 0.0016	0.0010 - 0.0018	0.0012 - 0.0020
K	Grey Cast Iron, Ductile Iron, Spheroidal Cast Iron (Pearlitic)	< 200	0.0004 - 0.0007	0.0005 - 0.0007	0.0005 - 0.0010	0.0008 - 0.0014
		> 200	0.0004 - 0.0007	0.0005 - 0.0007	0.0005 - 0.0010	0.0008 - 0.0014
	Spheroidal Cast Iron (Ferritic)	260 - 320	0.0004 - 0.0007	0.0005 - 0.0007	0.0005 - 0.0010	0.0008 - 0.0014
N	Copper and Alloys	< 500	0.0004 - 0.0007	0.0007 - 0.0016	0.0010 - 0.0018	0.0012 - 0.0020
	Brass	< 180	0.0004 - 0.0007	0.0007 - 0.0016	0.0010 - 0.0018	0.0012 - 0.0020
	Bronze	< 180	0.0004 - 0.0007	0.0007 - 0.0016	0.0010 - 0.0018	0.0012 - 0.0020
	Bronze Phosphorous	< 180	0.0004 - 0.0007	0.0007 - 0.0016	0.0010 - 0.0018	0.0012 - 0.0020
	Aluminum and Alloys	< 150	0.0004 - 0.0007	0.0007 - 0.0016	0.0010 - 0.0018	0.0012 - 0.0020

*Stock value is on diameter.

A
DRILLING
B
BORING
C
REAMING
D
BURNISHING
E
THREADING
X
SPECIALS

Recommended Cutting Data | Metric (mm)

Roller Burnishing

ISO	Material	Hardness (BHN)	Speed (M/min)	Recommended Feed (mm/rev) by Burnisher Diameter			
				4.70 - 12.00	12.01 - 25.00	25.01 - 50.00	50.01 - 165.90
P	Free Machining Steel 1118, 1215, 12L14, etc.	100 - 180	22 - 90	0.13 - 0.51	0.36 - 0.94	0.81 - 2.18	1.78 - 3.07
		180 - 250	22 - 90	0.13 - 0.51	0.36 - 0.94	0.81 - 2.18	1.78 - 3.07
	Low Carbon Steel 1010, 1020, 1025, 1522, 1144, etc.	85 - 180	22 - 90	0.13 - 0.51	0.36 - 0.94	0.81 - 2.18	1.78 - 3.07
		180 - 275	22 - 90	0.13 - 0.51	0.36 - 0.94	0.81 - 2.18	1.78 - 3.07
	Medium Carbon Steel 1030, 1040, 1050, 1527, 1140, 1151, etc.	125 - 180	22 - 90	0.13 - 0.51	0.36 - 0.94	0.81 - 2.18	1.78 - 3.07
		180 - 325	22 - 90	0.13 - 0.51	0.36 - 0.94	0.81 - 2.18	1.78 - 3.07
	Alloy Steel 4140, 5140, 8640, etc.	125 - 180	22 - 90	0.13 - 0.51	0.36 - 0.94	0.81 - 2.18	1.78 - 3.07
		180 - 375	22 - 90	0.13 - 0.51	0.36 - 0.94	0.81 - 2.18	1.78 - 3.07
	High Strength Alloy 4340, 4330V, 300M, etc.	240 - 450	22 - 90	0.13 - 0.51	0.36 - 0.94	0.81 - 2.18	1.78 - 3.07
	Structural Steel A36, A285, A516, etc.	125 - 180	22 - 90	0.13 - 0.51	0.36 - 0.94	0.81 - 2.18	1.78 - 3.07
180 - 350		22 - 90	0.13 - 0.51	0.36 - 0.94	0.81 - 2.18	1.78 - 3.07	
Tool Steel H-13, H-21, A-4, O-2, S-3, etc.	150 - 200	22 - 90	0.13 - 0.51	0.36 - 0.94	0.81 - 2.18	1.78 - 3.07	
	200 - 250	22 - 90	0.13 - 0.51	0.36 - 0.94	0.81 - 2.18	1.78 - 3.07	
S	High Temp Alloy Hastelloy B, Inconel 600, etc.	140 - 310	15 - 45	0.13 - 0.51	0.36 - 0.94	0.81 - 2.18	1.78 - 3.07
	Titanium Alloy	140 - 310	15 - 45	0.13 - 0.51	0.36 - 0.94	0.81 - 2.18	1.78 - 3.07
M	Stainless Steel 400 Series 416, 420, etc.	135 - 350	22 - 60	0.13 - 0.51	0.36 - 0.94	0.81 - 2.18	1.78 - 3.07
	Stainless Steel 300 Series 304, 316, 17-4PH, etc.	135 - 275	22 - 60	0.13 - 0.51	0.36 - 0.94	0.81 - 2.18	1.78 - 3.07
K	Grey Cast Iron, Ductile Iron, Spheroidal Cast Iron (Pearlitic)	< 200	22 - 90	0.13 - 0.51	0.36 - 0.94	0.81 - 2.18	1.78 - 3.07
	Spheroidal Cast Iron (Ferritic)	> 200	22 - 90	0.13 - 0.51	0.36 - 0.94	0.81 - 2.18	1.78 - 3.07
	Spheroidal Cast Iron (Ferritic)	260 - 320	22 - 90	0.13 - 0.51	0.36 - 0.94	0.81 - 2.18	1.78 - 3.07
N	Copper and Alloys Brass	< 500	45 - 105	0.13 - 0.51	0.36 - 0.94	0.81 - 2.18	1.78 - 3.07
	Bronze	< 180	45 - 105	0.13 - 0.51	0.36 - 0.94	0.81 - 2.18	1.78 - 3.07
	Bronze Phosphorous						
	Aluminum and Alloys	< 150	45 - 105	0.13 - 0.51	0.36 - 0.94	0.81 - 2.18	1.78 - 3.07

Max RPM

Series	Max RPM
H	2000
I	1500
K	1200
L	1000
F	1000
M	900
N	900
O	700
P	600
Q	500
R	300
S	300
T	250
U	200

IMPORTANT: The speeds and feeds listed on these pages are a general starting point for all applications. Factory technical assistance is available through our Application Engineering department.

Stock Allowance | Metric (mm)

Roller Burnishing

ISO	Material	Hardness (BHN)	Recommended Stock (mm) by Burnisher Diameter*			
			4.70 - 12.00	12.01 - 25.00	25.01 - 50.00	50.01 - 165.90
P	Free Machining Steel 1118, 1215, 12L14, etc.	100 - 180	0.010 - 0.018	0.018 - 0.041	0.025 - 0.046	0.030 - 0.051
		180 - 250	0.010 - 0.018	0.018 - 0.041	0.025 - 0.046	0.030 - 0.051
	Low Carbon Steel 1010, 1020, 1025, 1522, 1144, etc.	85 - 180	0.010 - 0.018	0.018 - 0.041	0.025 - 0.046	0.030 - 0.051
		180 - 275	0.010 - 0.018	0.018 - 0.041	0.025 - 0.046	0.030 - 0.051
	Medium Carbon Steel 1030, 1040, 1050, 1527, 1140, 1151, etc.	125 - 180	0.010 - 0.018	0.018 - 0.041	0.025 - 0.046	0.030 - 0.051
		180 - 325	0.010 - 0.018	0.012 - 0.018	0.012 - 0.025	0.020 - 0.036
	Alloy Steel 4140, 5140, 8640, etc.	125 - 180	0.010 - 0.018	0.018 - 0.041	0.025 - 0.046	0.030 - 0.051
		180 - 375	0.010 - 0.018	0.012 - 0.018	0.012 - 0.025	0.020 - 0.036
	High Strength Alloy 4340, 4330V, 300M, etc.	240 - 450	0.010 - 0.018	0.012 - 0.018	0.012 - 0.025	0.020 - 0.036
	Structural Steel A36, A285, A516, etc.	125 - 180	0.010 - 0.018	0.018 - 0.041	0.025 - 0.046	0.030 - 0.051
	180 - 350	0.010 - 0.018	0.012 - 0.018	0.012 - 0.025	0.020 - 0.036	
Tool Steel H-13, H-21, A-4, O-2, S-3, etc.	150 - 200	0.010 - 0.018	0.018 - 0.041	0.025 - 0.046	0.030 - 0.051	
	200 - 250	0.010 - 0.018	0.012 - 0.018	0.012 - 0.025	0.020 - 0.036	
S	High Temp Alloy Hastelloy B, Inconel 600, etc.	140 - 310	0.010 - 0.018	0.012 - 0.018	0.012 - 0.025	0.020 - 0.036
	Titanium Alloy	140 - 310	0.010 - 0.018	0.012 - 0.018	0.012 - 0.025	0.020 - 0.036
M	Stainless Steel 400 Series 416, 420, etc.	135 - 350	0.010 - 0.018	0.018 - 0.041	0.025 - 0.046	0.030 - 0.051
	Stainless Steel 300 Series 304, 316, 17-4PH, etc.	135 - 275	0.010 - 0.018	0.018 - 0.041	0.025 - 0.046	0.030 - 0.051
K	Grey Cast Iron, Ductile Iron, Spheroidal Cast Iron (Pearlitic)	< 200	0.010 - 0.018	0.012 - 0.018	0.012 - 0.025	0.020 - 0.036
		> 200	0.010 - 0.018	0.012 - 0.018	0.012 - 0.025	0.020 - 0.036
	Spheroidal Cast Iron (Ferritic)	260 - 320	0.010 - 0.018	0.012 - 0.018	0.012 - 0.025	0.020 - 0.036
N	Copper and Alloys	< 500	0.010 - 0.018	0.018 - 0.041	0.025 - 0.046	0.030 - 0.051
	Brass	< 500	0.010 - 0.018	0.018 - 0.041	0.025 - 0.046	0.030 - 0.051
	Bronze	< 180	0.010 - 0.018	0.018 - 0.041	0.025 - 0.046	0.030 - 0.051
	Bronze Phosphorous	< 180	0.010 - 0.018	0.018 - 0.041	0.025 - 0.046	0.030 - 0.051
	Aluminum and Alloys	< 150	0.010 - 0.018	0.018 - 0.041	0.025 - 0.046	0.030 - 0.051

*Stock value is on diameter.

A
DRILLING
B
BORING
C
REAMING
D
BURNISHING
E
THREADING
X
SPECIALS

Threading Solutions

Solid Carbide and Indexable Thread Mills | AccuThread™ 856 | ThreadMills USA

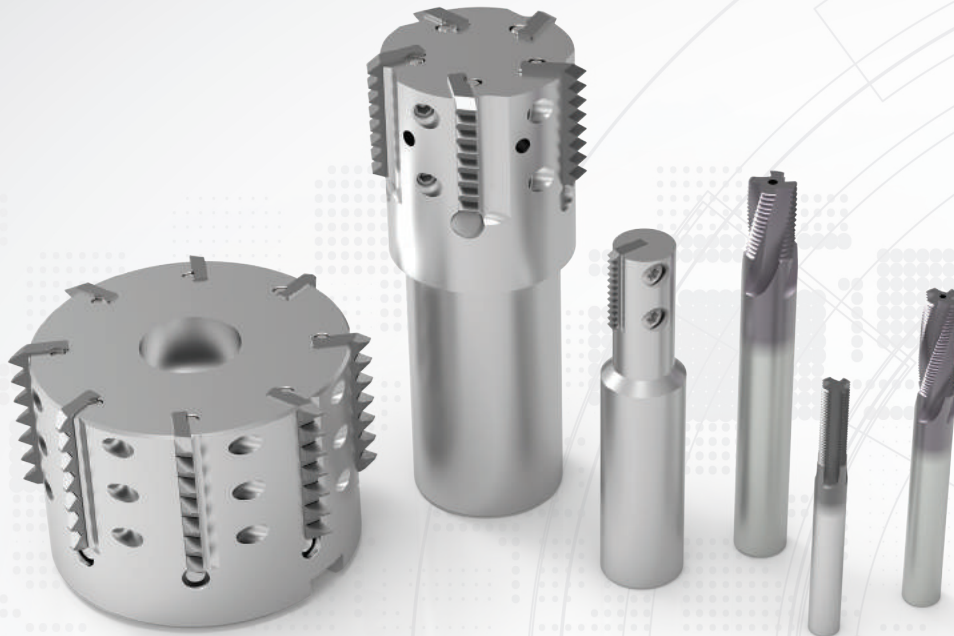

Any Thread, Any Time

Allied Machine's thread milling product line has developed into a comprehensive range of high precision tooling that offers outstanding productivity with exceptional levels of tool life and thread accuracy. The thread mill range covers both solid carbide and indexable replaceable insert tools with an extensive range of thread forms.

Our thread milling product line has been specifically designed to provide customers with a wide range of options. This is achieved by offering two thread mill ranges within our product lineup: the low cost, general production ThreadMills USA range, and the high performance, high productivity AccuThread™ range.

Online programmer available 24/7	Solid carbide and indexable insert styles	Large range of thread form options
----------------------------------	---	------------------------------------

Applicable Industries



Your safety and the safety of others is very important. This catalog contains important safety messages. Always read and follow all safety precautions.



This triangle is a safety hazard symbol. It alerts you to potential safety hazards that can cause tool failure and serious injury.

When you see this symbol in the catalog, look for a related safety message that may be near this triangle or referred to in the nearby text.

There are safety signal words also used in the catalog. Safety messages follow these words.

WARNING

WARNING (shown above) means that failure to follow the precautions in this message could result in tool failure and serious injury.

NOTICE means that failure to follow the precautions in this message could result in damage to the tool or machine but not result in personal injury.

NOTE and **IMPORTANT** are also used. These are important that you read and follow but are not safety-related.

Visit www.alliedmachine.com for the most up-to-date information and procedures.

Reference Icons

The following icons will appear throughout the catalog to help you navigate between products.

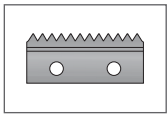

Bolt-in Style Inserts

Refers to the available bolt-in style thread mill insert options

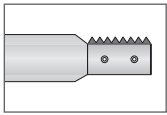

Bolt-in Style Insert Holders

Refers to the range of holder options available for bolt-in style inserts

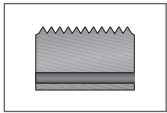

Pin Style Inserts

Refers to the available pin style thread mill insert options.

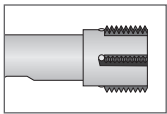

Pin Style Insert Holders

Refers to the range of holder options available for pin style inserts



Setup / Assembly Information

Detailed instructions and information regarding the corresponding part(s)

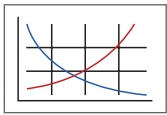

Recommended Cutting Data

Speed and feed recommendations for optimum and safe threading



Coolant Through Option

Indicates that the product is coolant through

Introduction Information

Thread Mill Items Overview 2
 Online Tools 3

Solid Carbide Thread Mills

Product Overview 4
 Product Nomenclature 5
 BSW Thread Form 6 - 7
 BSPT Thread Form 8
 BSPP Thread Form 9
 NPT Thread Form 10 - 11
 NPTF Thread Form 12 - 13
 NPS Thread Form 14
 NPSF Thread Form 15
 UN Thread Form 16 - 23
 ISO Thread Form 24 - 27

Indexable Thread Mills

Product Overview 28
 Product Nomenclature 29
Bolt-in Style:
 NPT / NPTF Thread Forms 30
 BSPT / BSPP Thread Forms 31
 UN Thread Form 32
 UNJ Thread Form 33
 ISO Thread Form 34
 Holders 35
Pin Style:
 NPT / NPTF / BSPT Thread Forms 36
 BSPP / API-ROUND / ACME Thread Forms 37
 UN Thread Form 38 - 39
 UNJ Thread Form 40
 ISO Thread Form 41
 Holders 42 - 43

Recommended Cutting Data



Pre-Drill Information 44
 Formulas and Recommended Pass Chart 45
 Solid Carbide: AccuThread™ 856 46 - 47
 Solid Carbide: ThreadMills USA 48 - 49
 Indexable: AccuThread™ 856 50 - 53
 Programming Guide 54 - 55
 Troubleshooting Guide 56 - 57



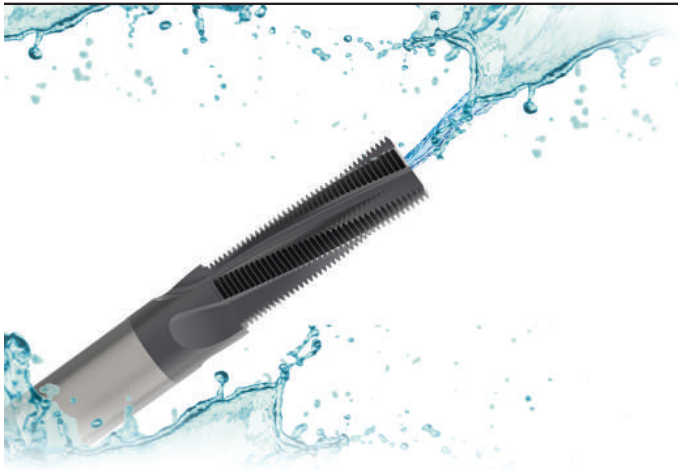

High Performance Threading Solutions

THREAD MILLING DONE *RIGHT*

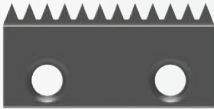

A DRILLING
B BORING
C REAMING
D BURISHING
E THREADING
X SPECIALS

Solid Carbide Thread Mills		Notes
AccuThread™ 856		<ul style="list-style-type: none"> • Allied Machine's proprietary AM210® coating yields a 25-50% increase in tool life over competitor products • Standard cutting lengths allow for multiple applications without the need for special thread mills • Helical flute offers increased strength and rigidity when cutting forces are applied
ThreadMills USA		<ul style="list-style-type: none"> • Helical flute offers increased strength and rigidity when cutting forces are applied • High quality for consistent, predictable production • Coolant through options available • TiAlN coating improves tool life versus uncoated tools 

Indexable Insert Thread Mills		Notes
AccuThread™ 856 Bolt-in Style		<ul style="list-style-type: none"> • Thread mill holders are manufactured from stainless steel that is engineered to dampen vibration during operation • Extensive range of thread forms with two thread lengths • Can produce left or right handed threads
AccuThread™ 856 Pin Style		<ul style="list-style-type: none"> • Patented pin style locking system ensures unsurpassed repeatability • Thread mill holders are manufactured from stainless steel that is engineered to dampen vibration during operation • Extensive range of thread forms with two thread lengths
AccuThread™ 856 Indexable Inserts	  <p>Bolt-in Style Pin Style</p>	<ul style="list-style-type: none"> • Full profiles present on all inserts allow 100% thread form against 65-75% for tapping • Allied Machine's premium carbide allows for extended tool life while providing high quality thread forms • Allied Machine's proprietary AM210® coating yields a 25-50% increase in tool life over competitor products

Online Tools

Insta-Code™

Find your thread mill. Create your program.



The user-friendly software lets you choose the best thread mill product for your application and create the program code for your machine. Insta-Code is available across multiple platforms, including the mobile device app, the PC download app (that can be used offline), and the online web app available 24/7 at www.alliedmachine.com.



Eliminate the wait. Get your program now.



Insta-Code also has a **Cycle Time Calculator**

Insta-Quote™

Design, create, and quote tools in minutes.

Available online 24/7



Solid Carbide Thread Mills (both AccuThread™ 856 and ThreadMills USA)

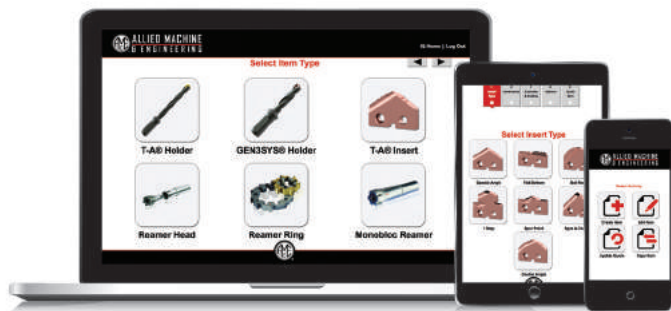

Insta-Quote is the online system that lets you design special tooling for your specific application. Receive your drawing and quote within seconds after you complete your design.

Now, you can quickly find the exact thread mill you need with Insta-Quote. Go online today and let Insta-Quote help solve your applications. After all, why should you do all the work?

Solid Carbide Styles and Thread Forms

Thread Forms	AccuThread™ 856 - Non-Coolant	ThreadMills USA - Non-Coolant	ThreadMills USA - Coolant Through
Straight BSW			
Helical BSPP, NPS, NPSF, UN, ISO			
Taper Helical BSPT, NPT, NPTF			

The Complete Package

Producing fully finished threaded hydraulic ports has never been easier. The Port and Thread Finishing Kit includes the AccuPort 432® port contour cutter with a dedicated AccuThread 856 solid carbide thread mill in a single kit. You also receive the T-A® inserts and port form inserts needed to complete the assembly.

Port kits incorporate the AccuThread 856 solid carbide thread mills to increase the manufacturing flexibility by allowing hydraulic ports to be produced in just two operations. In addition, where a unique port profile is required, Allied Machine provides a dedicated special tooling solution using our extensive tool design and manufacturing experience to meet precise specifications.

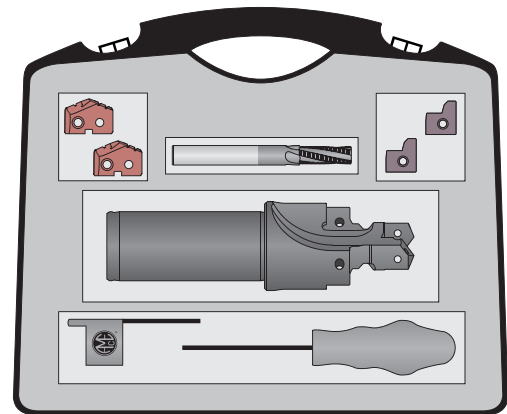

NOTE: See Section A9 of our product catalog for the complete list of Port and Thread Finishing Kits.



One Tool, FOUR Operations

- Spot Face
- Port Contour
- Tap Drill
- Spot Drill



NOTE: See Section A92 of our product catalog for full AccuPort 432 product line information.



Product Nomenclature

AccuThread™ 856 Solid Carbide Thread Mills

TM	U	K	0250	-	20	M
1	2	3	4		5	6



1. Thread Mill	2. Thread Class	3. Coating	4. Min Thread Diameter	5. Thread Pitch	6. Shank
TM = Standard HDTM = Heavy duty	U = UN N = NPT, NPTF B = BSPP, BSPT, BSW M = ISO A = AccuPort® specific	K = AM210® U = Uncoated	0250 = 1/4 (English) 0008 = #8 (Number Drill) 0450 = M4.5 (ISO)	20 = UN 20 TPI 075 = ISO 0.75 NPT = All pipe threads will show thread form	Blank = Imperial M = Metric

ThreadMills USA Solid Carbide Thread Mills

TM	250	20	CH	M
1	2	3	4	5



1. Thread Mill	2. Min Thread Diameter	3. Thread Pitch	4. Optional	5. Shank
TM = TiAlN TMFT = Uncoated HDTM = Heavy duty HDTMFT = Heavy duty uncoated	250 = 1/4 (English) 08 = #8 (Number Drill) 45 = M4.5 (ISO)	20 = UN 20 TPI 075 = ISO 0.75 NPT = All pipe threads will show thread form	CH = Coolant hole DE = Double end NPT = All pipe threads will show thread form	Blank = Imperial M = Metric

Reference Key

Symbol	Attribute
D_1	Maximum cutter diameter
D_2	Shank diameter
L_1	Overall length
L_6	Length of cut

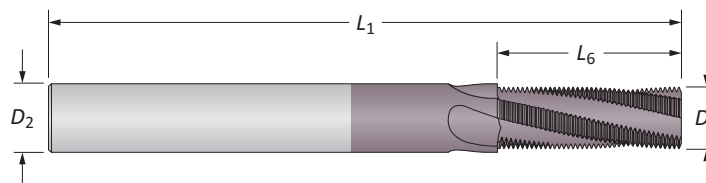

Solid Carbide Thread Mills

BSW | Non-Coolant

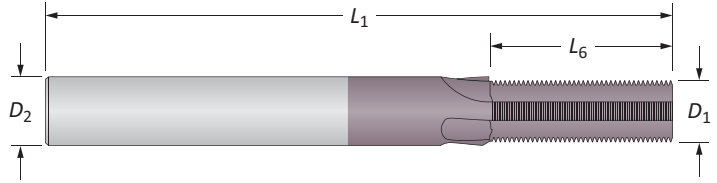
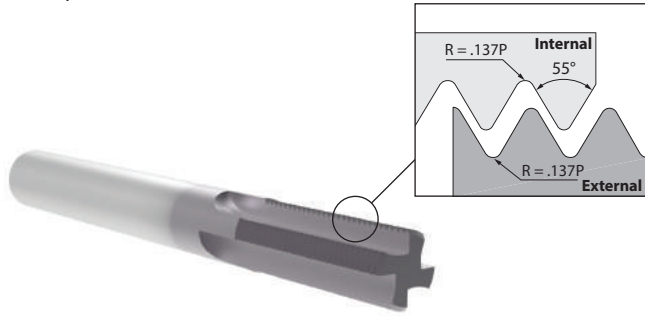

BSW | Non-Coolant

TPI (Pitch)	Min Thread Ø	Flutes	Thread Mill				Part No.	
			D_1	D_2	L_6	L_1	ThreadMills USA	AccuThread™ 856
20	1/4	3	0.177	0.250	0.400	2.500	TM20BSW	-
18	5/16	3	0.197	0.250	0.445	2.500	TM18BSW	-
16	3/8	5	0.276	0.312	0.563	3.000	TM16BSW	-
14	7/16	5	0.311	0.312	0.715	3.000	TM14BSW	-
i 12	1/2	5	0.354	0.375	0.750	3.500	TM12BSW	-
11	5/8	5	0.468	0.500	0.910	3.500	TM11BSW	-
10	3/4	5	0.468	0.500	1.100	3.500	TM10BSW	-
9	7/8	6	0.620	0.625	1.112	4.000	TM9BSW	-
8	1	6	0.620	0.625	1.375	4.000	TM8BSW	-
20	1/4	3	4.50	6.00	10.16	58.00	TM20BSWM	TMBK0250-20M
18	5/16	3	5.00	6.00	11.29	58.00	TM18BSWM	TMBK0312-18M
16	3/8	5	7.00	8.00	14.29	64.00	TM16BSWM	TMBK0375-16M
14	7/16	5	7.90	8.00	18.15	64.00	TM14BSWM	TMBK0437-14M
m 12	1/2	5	9.00	10.00	19.10	73.00	TM12BSWM	TMBK0500-12M
11	5/8	5	11.90	12.00	23.10	84.00	TM11BSWM	TMBK0625-11M
10	3/4	5	11.90	12.00	27.94	84.00	TM10BSWM	TMBK0750-10M
9	7/8	6	15.90	16.00	28.23	93.00	TM9BSWM	TMBK0875-9M
8	1	6	15.90	16.00	34.94	93.00	TM8BSWM	TMBK1000-8M

A DRILLING
B BORING
C REAMING
D BURNISHING
E THREADING
X SPECIALS

E: 46 - 49

E: 4

Weldon Flat

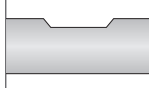
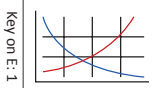

To order a thread mill with a Weldon flat, replace the leading TM designator with TW (available for inch shanks 3/8 and above, or metric shanks 6mm and above)

Example: Cylindrical shank = **TM**NK0500-NPT | Weldon shank flat = **TWN**K0500-NPT

NOTE: Weldon flats have a minimum order quantity of 2 pieces

i = Imperial (in)
m = Metric (mm)



Solid Carbide Thread Mills

BSW | Coolant Through

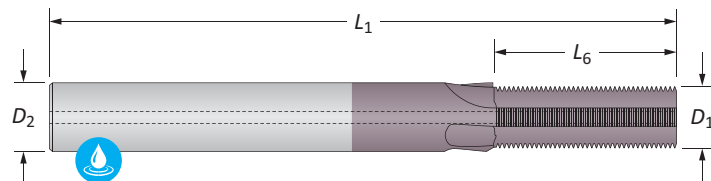
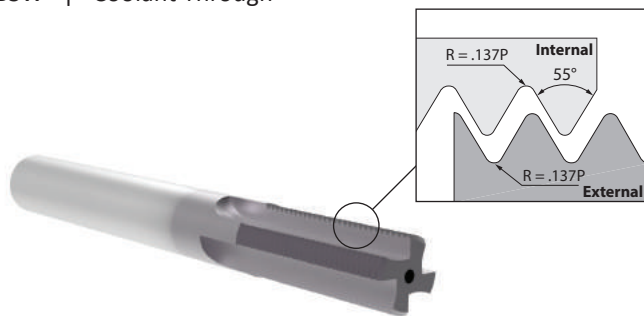

BSW | Coolant Through

	TPI (Pitch)	Min Thread \varnothing	Flutes	Thread Mill				Part No.
				D_1	D_2	L_6	L_1	ThreadMills USA
i	20	1/4	3	0.177	0.250	0.400	2.375	TM20BSWCH
	18	5/16	3	0.197	0.250	0.445	2.375	TM18BSWCH
	16	3/8	5	0.276	0.312	0.563	3.000	TM16BSWCH
	14	7/16	5	0.311	0.312	0.715	3.000	TM14BSWCH
	12	1/2	5	0.354	0.375	0.750	3.000	TM12BSWCH
	11	5/8	5	0.468	0.500	0.910	3.500	TM11BSWCH
	10	3/4	5	0.468	0.500	1.100	3.500	TM10BSWCH
	9	7/8	6	0.620	0.625	1.112	4.000	TM9BSWCH
	8	1	6	0.620	0.625	1.375	4.000	TM8BSWCH
m	20	1/4	3	4.50	6.00	10.16	58.00	TM20BSWCHM
	18	5/16	3	5.00	6.00	11.29	58.00	TM18BSWCHM
	16	3/8	5	7.00	8.00	14.29	64.00	TM16BSWCHM
	14	7/16	5	7.90	8.00	18.15	64.00	TM14BSWCHM
	12	1/2	5	9.00	10.00	19.10	84.00	TM12BSWCHM
	11	5/8	5	11.90	12.00	23.10	84.00	TM11BSWCHM
	10	3/4	5	11.90	12.00	27.94	84.00	TM10BSWCHM
	9	7/8	6	15.90	16.00	28.23	93.00	TM9BSWCHM
	8	1	15.90	16.00	34.94	93.00	TM8BSWCHM	

E: 46 - 49

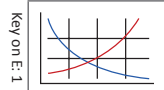

E: 4



Weldon Flat

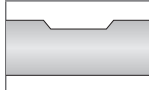

To order a thread mill with a Weldon flat, replace the leading TM designator with TW (available for inch shanks 3/8 and above, or metric shanks 6mm and above)
Example: Cylindrical shank = **TM**NK0500-NPT | Weldon shank flat = **TW**NK0500-NPT
NOTE: Weldon flats have a minimum order quantity of 2 pieces

i = Imperial (in)
 m = Metric (mm)

A

DRILLING

B

BORING

C

REAMING

D

BURNISHING

E

THREADING

X



SPECIALS

Solid Carbide Thread Mills

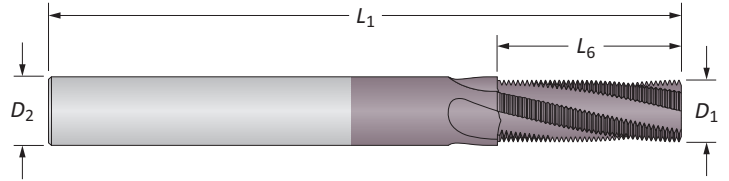
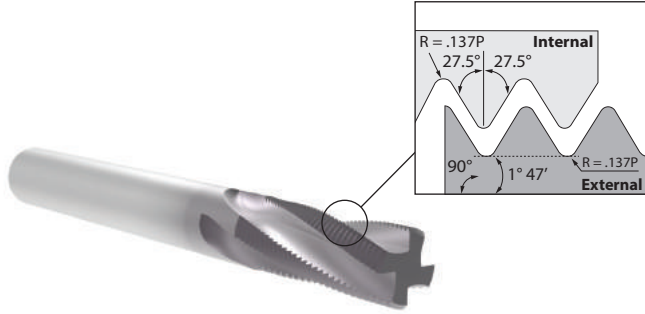
BSPT



BSPT | Non-Coolant

	TPI (Pitch)	Min Thread ϕ	Flutes	Thread Mill				Part No.	
				D_1	D_2	L_6	L_1	 ThreadMills USA	 AccuThread™ 856
i	28	1/16 and 1/8	3	0.240	0.250	0.393	2.500	TM28BSPT	-
	19	1/4 and 3/8	4	0.310	0.312	0.580	3.000	TM19BSPT	-
	14	1/2 and 3/4	4	0.470	0.500	0.787	3.500	TM14BSPT	-
	11	1	4	0.620	0.625	1.546	4.000	TM11BSPT	-
m	28	1/16 and 1/8	3	5.97	6.00	9.98	58.00	TM28BSPTM	TMBK0063-BSPTM
	19	1/4 and 3/8	4	9.91	10.00	14.73	73.00	TM19BSPTM	TMBK0250-BSPTM
	14	1/2 and 3/4	4	11.94	12.00	20.00	84.00	TM14BSPTM	TMBK0500-BSPTM
	11	1	4	15.75	16.00	32.31	93.00	TM11BSPTM	TMBK1000-BSPTM

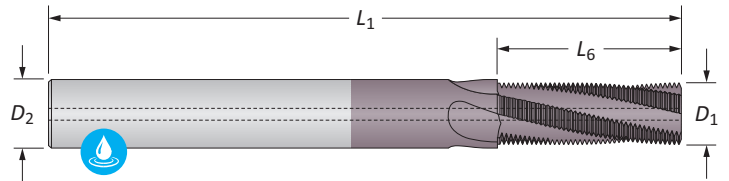
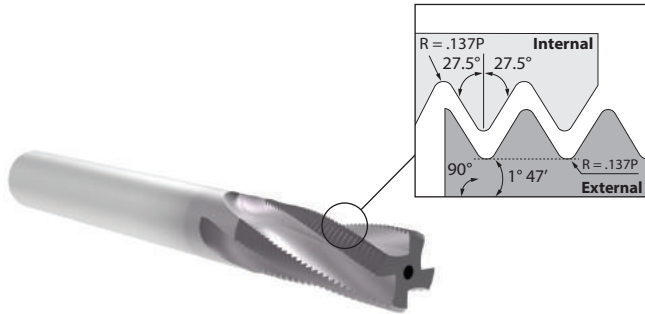

BSPT | Coolant Through

	TPI (Pitch)	Min Thread ϕ	Flutes	Thread Mill				Part No.
				D_1	D_2	L_6	L_1	 ThreadMills USA
i	28	1/16 and 1/8	3	0.240	0.250	0.393	2.375	TM28BSPTCH
	19	1/4 and 3/8	4	0.310	0.312	0.580	3.000	TM19BSPTCH
	14	1/2 and 3/4	4	0.470	0.500	0.787	3.500	TM14BSPTCH
	11	1	4	0.620	0.625	1.546	4.000	TM11BSPTCH
m	28	1/16 and 1/8	3	5.97	6.00	9.98	58.00	TM28BSPTCHM
	19	1/4 and 3/8	4	9.91	10.00	14.73	84.00	TM19BSPTCHM
	14	1/2 and 3/4	4	11.94	12.00	20.00	84.00	TM14BSPTCHM
	11	1	4	15.75	16.00	32.31	93.00	TM11BSPTCHM

E: 46 - 49

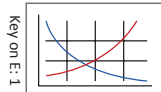

E: 4



Weldon Flat

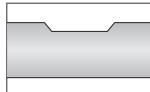

To order a thread mill with a Weldon flat, replace the leading TM designator with TW (available for inch shanks 3/8 and above, or metric shanks 6mm and above)
Example: Cylindrical shank = **TW**NK0500-NPT | Weldon shank flat = **TWN**K0500-NPT
NOTE: Weldon flats have a minimum order quantity of 2 pieces

i = Imperial (in)
 m = Metric (mm)



Solid Carbide Thread Mills

BSPB

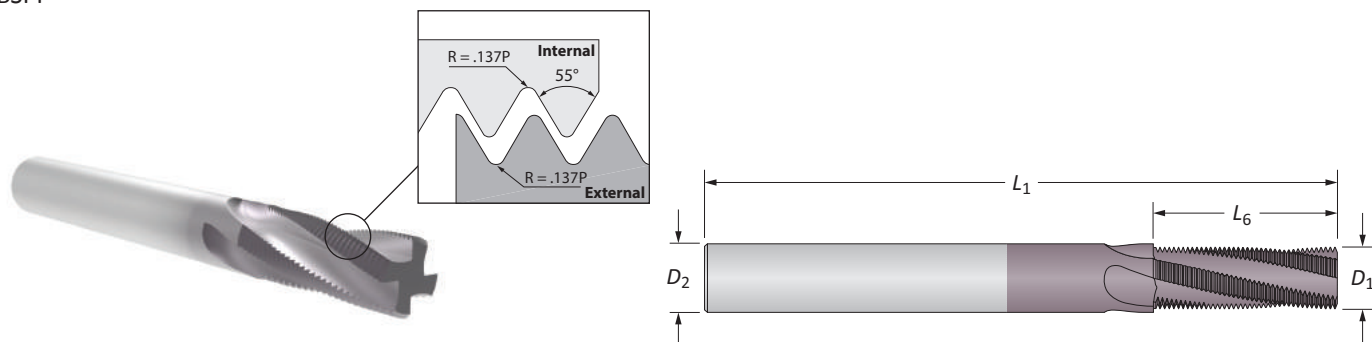

BSPB | Non-Coolant

	TPI (Pitch)	Min Thread Ø	Flutes	Thread Mill				Part No.	
				D ₁	D ₂	L ₆	L ₁	ThreadMills USA	AccuThread™ 856
i	28	1/16 and 1/8	3	0.240	0.250	0.572	2.500	TM28BSPP	-
	19	1/4 and 3/8	4	0.310	0.312	0.737	3.000	TM19BSPP	-
	14	1/2 and 3/4	4	0.470	0.500	1.143	3.500	TM14BSPP	-
	11	1	4	0.620	0.625	1.365	4.000	TM11BSPP	-
m	28	1/16 and 1/8	3	5.97	6.00	14.53	58.00	TM28BSPPM	TMBK0063-BSPPM
	19	1/4 and 3/8	4	9.91	10.00	18.72	73.00	TM19BSPPM	TMBK0250-BSPPM
	19	3/8	4	11.94	12.00	28.41	84.00	HDTM19BSPPM	-
	14	1/2 and 3/4	4	11.94	12.00	29.03	84.00	TM14BSPPM	TMBK0500-BSPPM
	14	3/4	5	15.75	16.00	34.47	93.00	HDTM14BSPPM	-
	11	1	4	15.75	16.00	34.67	93.00	TM11BSPPM	TMBK1000-BSPPM

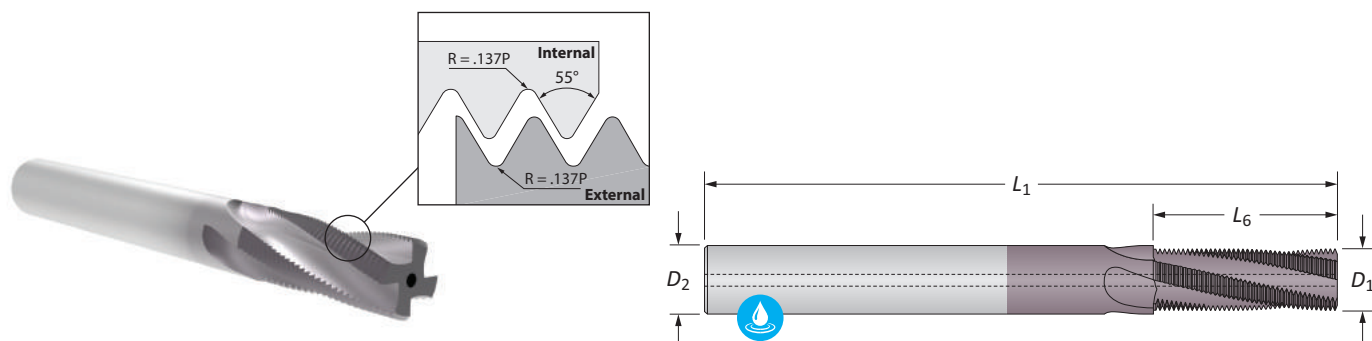

BSPB | Coolant Through

	TPI (Pitch)	Min Thread Ø	Flutes	Thread Mill				Part No.
				D ₁	D ₂	L ₆	L ₁	ThreadMills USA
i	28	1/16 and 1/8	3	0.240	0.250	0.572	2.375	TM28BSPPCH
	19	1/4 and 3/8	4	0.310	0.312	0.737	3.000	TM19BSPPCH
	14	1/2 and 3/4	4	0.470	0.500	1.143	3.500	TM14BSPPCH
	11	1	4	0.620	0.625	1.365	4.000	TM11BSPPCH
m	28	1/16 and 1/8	3	5.97	6.00	14.53	58.00	TM28BSPPCHM
	19	1/4 and 3/8	4	9.91	10.00	18.72	84.00	TM19BSPPCHM
	14	1/2 and 3/4	4	11.94	12.00	29.03	84.00	TM14BSPPCHM
	11	1	4	15.75	16.00	34.67	93.00	TM11BSPPCHM

E: 46 - 49

E: 4

Weldon Flat

Key on E: 1

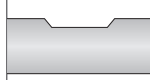
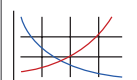

To order a thread mill with a Weldon flat, replace the leading TM designator with TW (available for inch shanks 3/8 and above, or metric shanks 6mm and above)
Example: Cylindrical shank = **TM**NK0500-NPT | Weldon shank flat = **TW**NK0500-NPT
NOTE: Weldon flats have a minimum order quantity of 2 pieces

i = Imperial (in)
 m = Metric (mm)

Solid Carbide Thread Mills

NPT | Non-Coolant

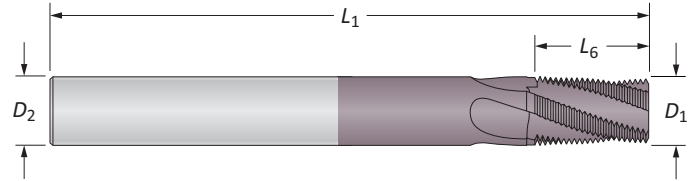
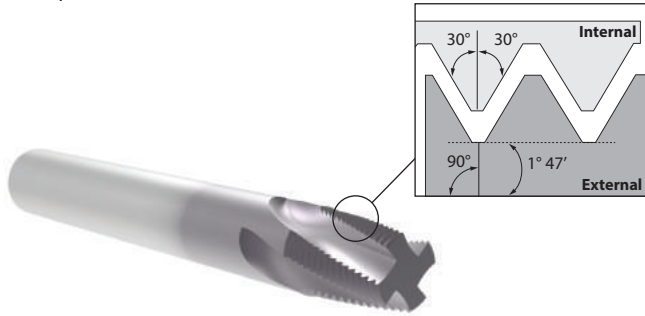

NPT | Non-Coolant

TPI (Pitch)	Min Thread Ø	Flutes	Thread Mill				Part No.	
			D ₁	D ₂	L ₆	L ₁	ThreadMills USA	AccuThread™ 856
27	1/16 and 1/8	3	0.245	0.250	0.437	2.500	TM27NPT	TMNK0063-NPT
27	1/8	4	0.300	0.312	0.482	3.000	HDTM27NPT	HDTMNK0125-NPT
18	1/4 and 3/8	4	0.305	0.312	0.625	3.000	TM18NPT	TMNK0250-NPT
18	1/4 and 3/8	4	0.363	0.375	0.680	3.500	HDTM18NPT	HDTMNK0250-NPT
i 14	1/2 and 3/4	4	0.495	0.500	0.875	3.500	TM14NPT	TMNK0500-NPT
14	3/4	4	0.620	0.625	1.000	4.000	HDTM14NPT	HDTMNK0750-NPT
11.5	1	4	0.620	0.625	1.125	4.000	TM11NPT	TMNK1000-NPT
11.5	1	5	0.745	0.750	1.219	4.000	HDTM11NPT	HDTMNK1000-NPT
8	2-1/2	4	0.745	0.750	1.500	5.000	TM8NPT	TMNK2500-NPT
27	1/16 and 1/8	3	5.95	6.00	11.30	58.00	TM27NPTM	TMNK0063-NPTM
27	1/8	4	7.62	8.00	12.25	64.00	HDTM27NPTM	-
18	1/4 and 3/8	4	7.75	8.00	15.70	64.00	TM18NPTM	TMNK0250-NPTM
18	1/4 and 3/8	4	9.22	10.00	17.25	84.00	HDTM18NPTM	-
m 14	1/2 and 3/4	4	11.95	12.00	23.70	84.00	TM14NPTM	TMNK0500-NPTM
14	3/4	4	15.75	16.00	25.40	93.00	HDTM14NPTM	-
11.5	1	4	15.75	16.00	28.75	93.00	TM11NPTM	TMNK1000-NPTM
11.5	1	5	18.92	20.00	30.95	105.00	HDTM11NPTM	-
8	2-1/2	5	19.75	20.00	38.10	115.00	TM8NPTM	TMNK2500-NPTM

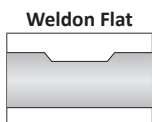
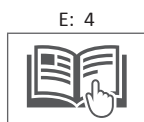
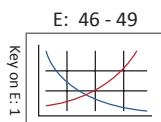

To order a thread mill with a Weldon flat, replace the leading TM designator with TW (available for inch shanks 3/8 and above, or metric shanks 6mm and above)
Example: Cylindrical shank = **TM**NK0500-NPT | Weldon shank flat = **TWN**K0500-NPT
NOTE: Weldon flats have a minimum order quantity of 2 pieces

i = Imperial (in)
m = Metric (mm)



Solid Carbide Thread Mills

NPT | Coolant Through

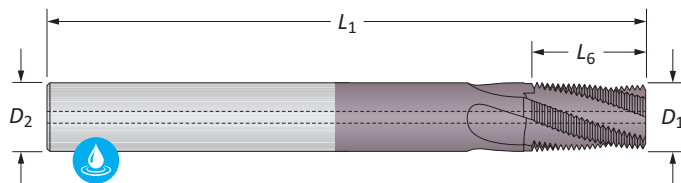
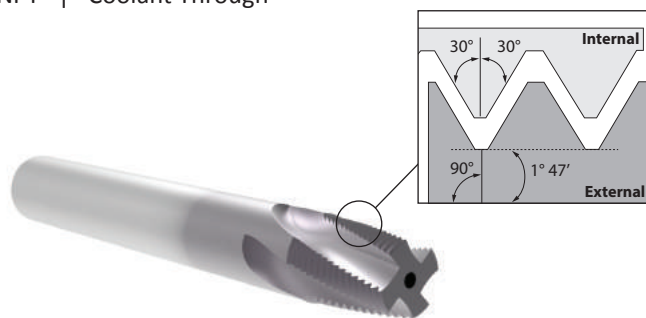

NPT | Coolant Through

	TPI (Pitch)	Min Thread Ø	Flutes	Thread Mill				Part No.
				D ₁	D ₂	L ₆	L ₁	ThreadMills USA
i	27	1/16 and 1/8	3	0.245	0.250	0.437	2.375	TM27NPTCH
	27	1/8	4	0.300	0.312	0.482	3.000	HDTM27NPTCH
	18	1/4 and 3/8	4	0.305	0.312	0.625	3.000	TM18NPTCH
	18	1/4 and 3/8	4	0.363	0.375	0.680	3.000	HDTM18NPTCH
	14	1/2 and 3/4	4	0.495	0.500	0.875	3.500	TM14NPTCH
	14	3/4	4	0.620	0.625	1.000	4.000	HDTM14NPTCH
	11.5	1	4	0.620	0.625	1.125	4.000	TM11NPTCH
	11	1	5	0.745	0.750	1.219	4.000	HDTM11NPTCH
	8	2-1/2	4	0.745	0.750	1.500	5.000	TM8NPTCH
m	27	1/16 and 1/8	3	5.95	6.00	11.30	58.00	TM27NPTCHM
	27	1/8	4	7.62	8.00	12.25	64.00	HDTM27NPTCHM
	18	1/4 and 3/8	4	7.75	8.00	15.70	64.00	TM18NPTCHM
	18	1/4 and 3/8	4	9.22	10.00	17.25	84.00	HDTM18NPTCHM
	14	1/2 and 3/4	4	11.95	12.00	23.70	84.00	TM14NPTCHM
	14	3/4	4	15.75	16.00	25.40	93.00	HDTM14NPTCHM
	11.5	1	4	15.75	16.00	28.75	93.00	TM11NPTCHM
	11.5	1	5	18.92	20.00	30.95	105.00	HDTM11NPTCHM
	8	2-1/2	5	19.75	20.00	38.10	115.00	TM8NPTCHM

E: 46 - 49

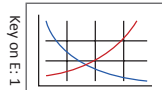

E: 4



Weldon Flat

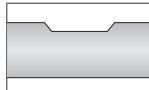

To order a thread mill with a Weldon flat, replace the leading TM designator with TW (available for inch shanks 3/8 and above, or metric shanks 6mm and above)
Example: Cylindrical shank = **TM**NK0500-NPT | Weldon shank flat = **TW**NK0500-NPT
NOTE: Weldon flats have a minimum order quantity of 2 pieces



i = Imperial (in)
 m = Metric (mm)

Solid Carbide Thread Mills

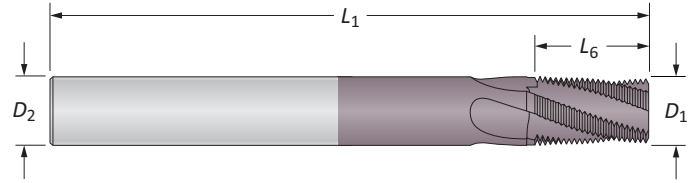
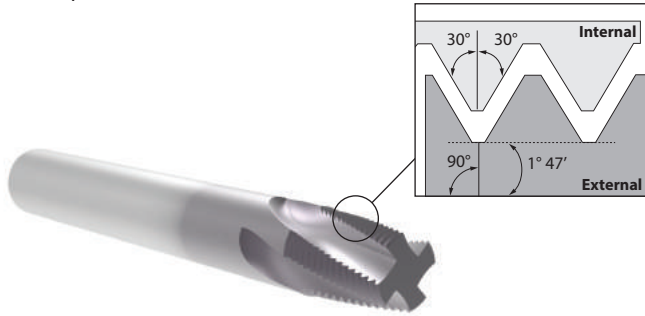
NPTF | Non-Coolant



NPTF | Non-Coolant

	TPI (Pitch)	Min Thread ϕ	Flutes	Thread Mill				Part No.	
				D_1	D_2	L_6	L_1	 ThreadMills USA	 AccuThread™ 856
i	27	1/16 and 1/8	3	0.245	0.250	0.437	2.500	TM27NPTF	TMNK0063-NPTF
	18	1/4 and 3/8	4	0.305	0.312	0.625	3.000	TM18NPTF	TMNK0250-NPTF
	14	1/2 and 3/4	4	0.495	0.500	0.875	3.500	TM14NPTF	TMNK0500-NPTF
	11.5	1	4	0.620	0.625	1.125	4.000	TM11NPTF	TMNK1000-NPTF
	8	2-1/2	4	0.745	0.750	1.500	5.000	TM8NPTF	TMNK2500-NPTF
m	27	1/16 and 1/8	3	5.95	6.00	11.30	58.00	TM27NPTFM	TMNK0063-NPTFM
	18	1/4 and 3/8	4	7.75	8.00	15.70	64.00	TM18NPTFM	TMNK0250-NPTFM
	14	1/2 and 3/4	4	11.95	12.00	23.70	84.00	TM14NPTFM	TMNK0500-NPTFM
	11.5	1	4	15.75	16.00	28.75	93.00	TM11NPTFM	TMNK1000-NPTFM
	8	2-1/2	5	19.75	20.00	38.10	115.00	TM8NPTFM	TMNK2500-NPTFM

D BURNISHING

F THREADING

X SPECIALS

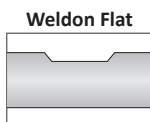
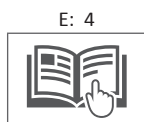
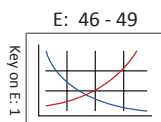

To order a thread mill with a Weldon flat, replace the leading TM designator with TW (available for inch shanks 3/8 and above, or metric shanks 6mm and above)
Example: Cylindrical shank = **TMNK0500-NPT** | Weldon shank flat = **TWKNK0500-NPT**
NOTE: Weldon flats have a minimum order quantity of 2 pieces

i = Imperial (in)
 m = Metric (mm)



Solid Carbide Thread Mills

NPTF | Coolant Through

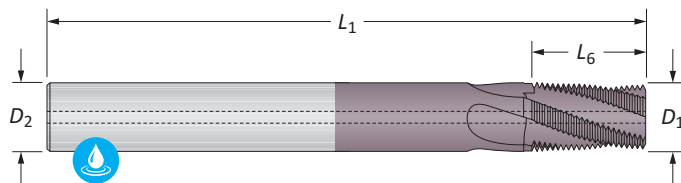
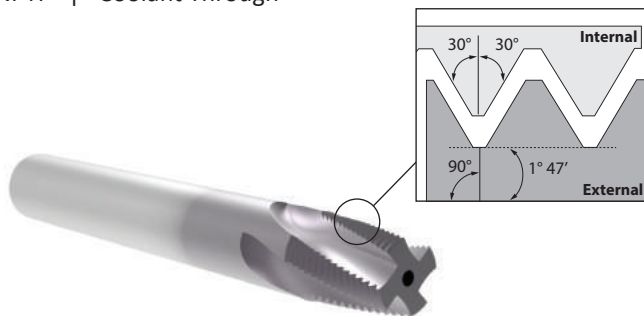

NPTF | Coolant Through

	TPI (Pitch)	Min Thread Ø	Flutes	Thread Mill				Part No.
				D_1	D_2	L_6	L_1	ThreadMills USA
i	27	1/16 and 1/8	3	0.245	0.250	0.437	2.375	TM27NPTFCH
	18	1/4 and 3/8	4	0.305	0.312	0.625	3.000	TM18NPTFCH
	14	1/2 and 3/4	4	0.495	0.500	0.875	3.500	TM14NPTFCH
	11.5	1	4	0.620	0.625	1.125	4.000	TM11NPTFCH
	8	2-1/2	4	0.745	0.750	1.500	5.000	TM8NPTFCH
m	27	1/16 and 1/8	3	5.95	6.00	11.30	58.00	TM27NPTFCHM
	18	1/4 and 3/8	4	7.75	8.00	15.70	64.00	TM18NPTFCHM
	14	1/2 and 3/4	4	11.95	12.00	23.70	84.00	TM14NPTFCHM
	11.5	1	4	15.75	16.00	28.75	93.00	TM11NPTFCHM
	8	2-1/2	5	19.75	20.00	38.10	115.00	TM8NPTFCHM

A

DRILLING

B

BORING

C

REAMING

D

BURNISHING

E

THREADING

X

SPECIALS

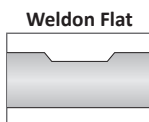
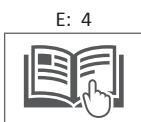
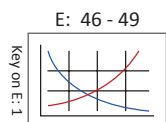

To order a thread mill with a Weldon flat, replace the leading TM designator with TW (available for inch shanks 3/8 and above, or metric shanks 6mm and above)
Example: Cylindrical shank = **TM**NK0500-NPT | Weldon shank flat = **TW**NK0500-NPT
NOTE: Weldon flats have a minimum order quantity of 2 pieces

i = Imperial (in)
 m = Metric (mm)

Solid Carbide Thread Mills

NPS

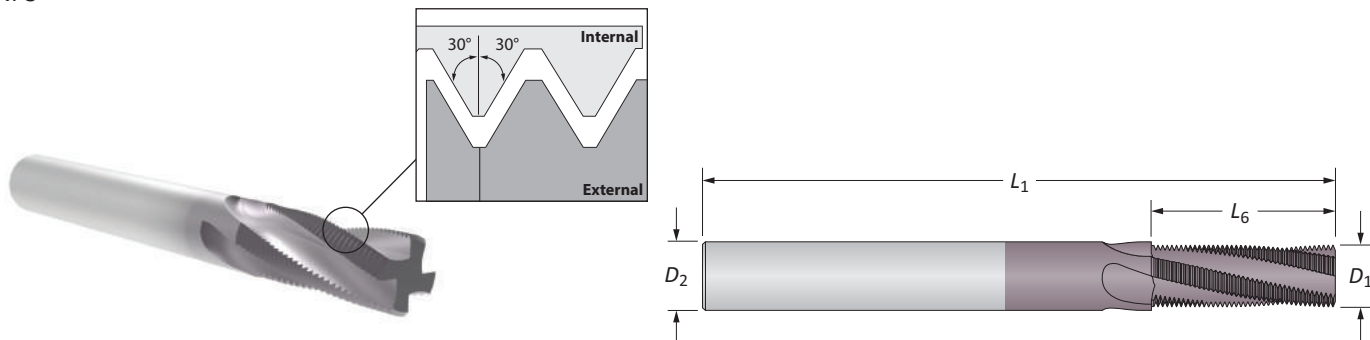

NPS | Non-Coolant

TPI (Pitch)	Min Thread Ø	Flutes	Thread Mill				Part No.
			D ₁	D ₂	L ₆	L ₁	
27	1/8	3	0.245	0.250	0.630	2.500	TM27NPS
18	1/4 and 3/8	4	0.370	0.375	0.889	3.500	TM18NPS
14	1/2 and 3/4	4	0.490	0.500	1.288	3.500	TM14NPS
11.5	1	4	0.620	0.625	1.392	4.000	TM11NPS
27	1/8	3	5.95	6.00	16.00	58.00	TM27NPSM
18	1/4 and 3/8	4	9.40	10.00	22.60	84.00	TM18NPSM
14	1/2 and 3/4	4	11.94	12.00	32.70	84.00	TM14NPSM
11.5	1	4	15.75	16.00	35.35	93.00	TM11NPSM

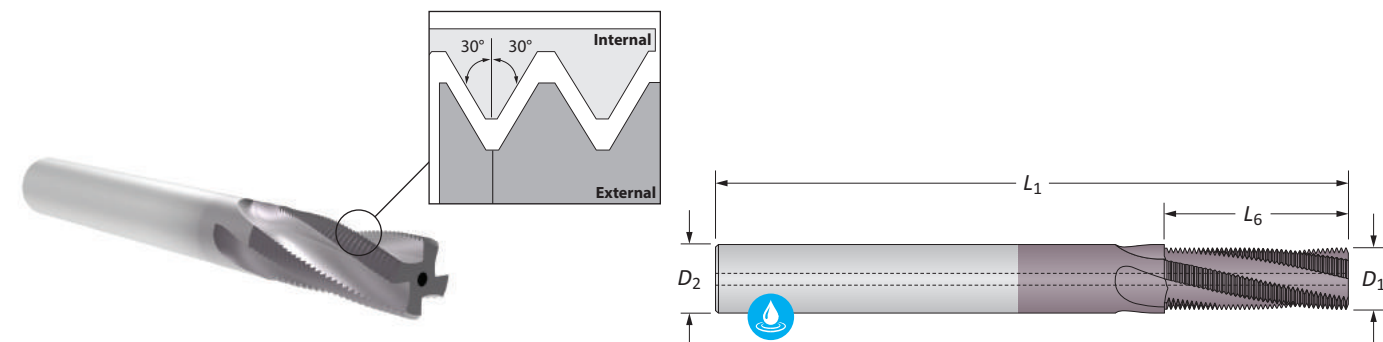

NPS | Coolant Through

TPI (Pitch)	Min Thread Ø	Flutes	Thread Mill				Part No.
			D ₁	D ₂	L ₆	L ₁	
27	1/8	3	0.245	0.250	0.630	2.375	TM27NPSCH
18	1/4 and 3/8	4	0.370	0.375	0.889	3.000	TM18NPSCH
14	1/2 and 3/4	4	0.490	0.500	1.288	3.500	TM14NPSCH
11.5	1	4	0.620	0.625	1.392	4.000	TM11NPSCH
27	1/8	3	5.95	6.00	16.00	58.00	TM27NPSCHM
18	1/4 and 3/8	4	9.40	10.00	22.60	84.00	TM18NPSCHM
14	1/2 and 3/4	4	11.94	12.00	32.70	84.00	TM14NPSCHM
11.5	1	4	15.75	16.00	35.35	93.00	TM11NPSCHM

E: 46 - 49

E: 4

Weldon Flat

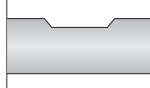
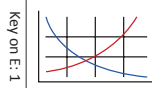

To order a thread mill with a Weldon flat, replace the leading TM designator with TW (available for inch shanks 3/8 and above, or metric shanks 6mm and above)

Example: Cylindrical shank = **TM**NK0500-NPT | Weldon shank flat = **TW**NK0500-NPT

NOTE: Weldon flats have a minimum order quantity of 2 pieces

i = Imperial (in)
m = Metric (mm)

A DRILLING

B BORING

C REAMING

D BURNISHING

E THREADING

X SPECIALS

Solid Carbide Thread Mills

NPSF

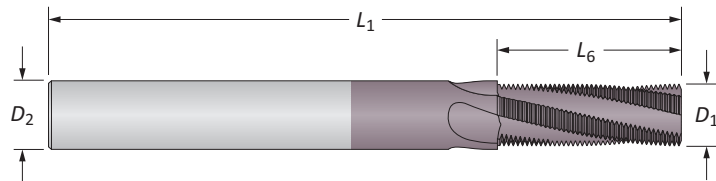
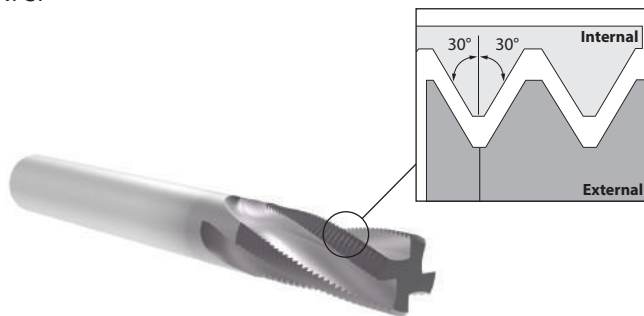

NPSF | Non-Coolant

	TPI (Pitch)	Min Thread Ø	Flutes	Thread Mill				Part No.
				D ₁	D ₂	L ₆	L ₁	ThreadMills USA
i	27	1/8	3	0.245	0.250	0.630	2.500	TM27NPSF
	18	1/4 and 3/8	4	0.370	0.375	0.889	3.500	TM18NPSF
	14	1/2 and 3/4	4	0.490	0.500	1.288	3.500	TM14NPSF
	11.5	1	4	0.620	0.625	1.392	4.000	TM11NPSF
m	27	1/8	3	5.95	6.00	16.00	58.00	TM27NPSFM
	18	1/4 and 3/8	4	9.40	10.00	22.60	84.00	TM18NPSFM
	14	1/2 and 3/4	4	11.94	12.00	32.70	84.00	TM14NPSFM
	11.5	1	4	15.75	16.00	35.35	93.00	TM11NPSFM

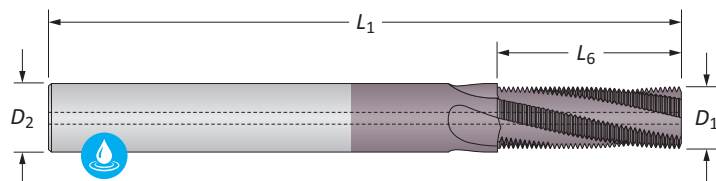
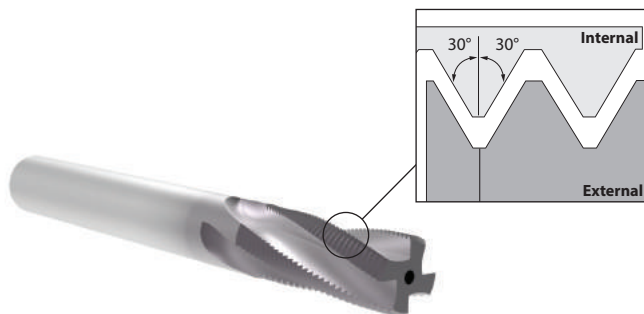

NPSF | Coolant Through

	TPI (Pitch)	Min Thread Ø	Flutes	Thread Mill				Part No.
				D ₁	D ₂	L ₆	L ₁	ThreadMills USA
i	27	1/8	3	0.245	0.250	0.630	2.375	TM27NPSFCH
	18	1/4 and 3/8	4	0.370	0.375	0.889	3.000	TM18NPSFCH
	14	1/2 and 3/4	4	0.490	0.500	1.288	3.500	TM14NPSFCH
	11.5	1	4	0.620	0.625	1.392	4.000	TM11NPSFCH
m	27	1/8	3	5.95	6.00	16.00	58.00	TM27NPSFCHM
	18	1/4 and 3/8	4	9.40	10.00	22.60	84.00	TM18NPSFCHM
	14	1/2 and 3/4	4	11.94	12.00	32.70	84.00	TM14NPSFCHM
	11.5	1	4	15.75	16.00	35.35	93.00	TM11NPSFCHM

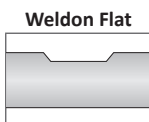
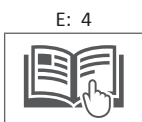
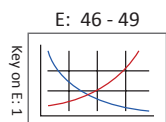

To order a thread mill with a Weldon flat, replace the leading TM designator with TW (available for inch shanks 3/8 and above, or metric shanks 6mm and above)
Example: Cylindrical shank = **TM**NK0500-NPT | Weldon shank flat = **TW**NK0500-NPT
NOTE: Weldon flats have a minimum order quantity of 2 pieces

i = Imperial (in)
 m = Metric (mm)



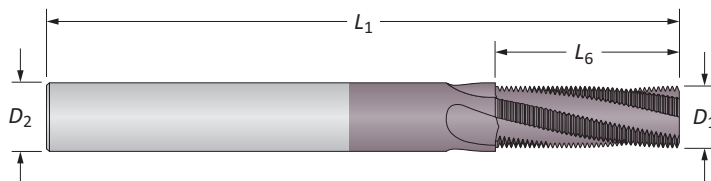
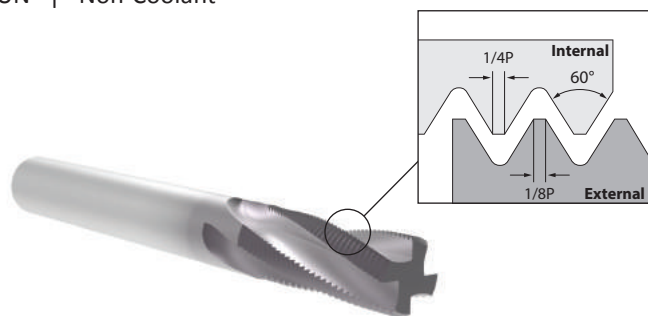

Solid Carbide Thread Mills

UN | Non-Coolant



UN | Non-Coolant

TPI (Pitch)	Min Thread Ø	Flutes	Thread Mill				Part No.	
			D_1	D_2	L_6	L_1	 ThreadMills USA	 AccuThread™ 856
64	#2	3*	0.065	0.125	0.125	2.000	TM08664	-
56	#2	3*	0.065	0.125	0.125	2.000	TM08656	TMUK0002-56
48	#3	3*	0.075	0.125	0.167	2.000	TM09948	-
44	#5	3	0.095	0.125	0.228	2.000	TM12544	-
40	#4	3*	0.085	0.125	0.175	2.000	TM12540	TMUK0004-40
36	#8	3	0.115	0.125	0.250	2.000	TM16436	-
32	#6	3	0.100	0.125	0.218	2.000	TM13832	TMUK0006-32
32	#8	3	0.115	0.125	0.250	2.000	TM16432	TMUK0008-32
32	#10	3	0.120	0.125	0.312	2.000	TM19032	TMUK0010-32
32	#10	3	0.150	0.187	0.312	2.500	HDTM19032	-
32	1/2	6	0.370	0.375	1.000	3.500	TM50032	-
i 28	#10	3	0.120	0.125	0.312	2.000	TM19028	TMUK0010-28
28	1/4	3	0.180	0.187	0.500	2.500	TM25028	TMUK0250-28
28	1/2	6	0.370	0.375	1.000	3.500	TM50028	-
24	#10	3	0.120	0.125	0.312	2.000	TM19024	TMUK0010-24
24	#10	3	0.145	0.187	0.312	2.500	HDTM19024	-
24	5/16	3	0.235	0.250	0.625	2.500	TM31224	TMUK0313-24
24	3/8	4	0.285	0.312	0.750	3.000	TM37524	TMUK0375-24
24	1/2	6	0.370	0.375	1.000	3.500	TM50024	-
20	1/4	3	0.180	0.187	0.500	2.500	TM25020	TMUK0250-20
20	1/4	3	0.195	0.250	0.500	2.500	HDTM25020	-
20	7/16	4	0.335	0.375	0.875	3.500	TM43720	TMUK0438-20
20	1/2	6	0.370	0.375	1.000	3.500	TM50020	-

*Straight fluted

E: 46 - 49

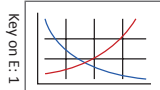

Key on E: 1

E: 4



Weldon Flat

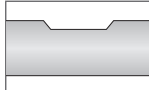

To order a thread mill with a Weldon flat, replace the leading TM designator with TW (available for inch shanks 3/8 and above, or metric shanks 6mm and above)

Example: Cylindrical shank = **TM**NK0500-NPT | Weldon shank flat = **TWN**K0500-NPT

NOTE: Weldon flats have a minimum order quantity of 2 pieces

i = Imperial (in)
m = Metric (mm)



Solid Carbide Thread Mills

UN | Non-Coolant (continued)

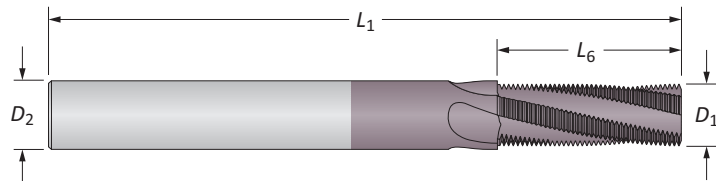
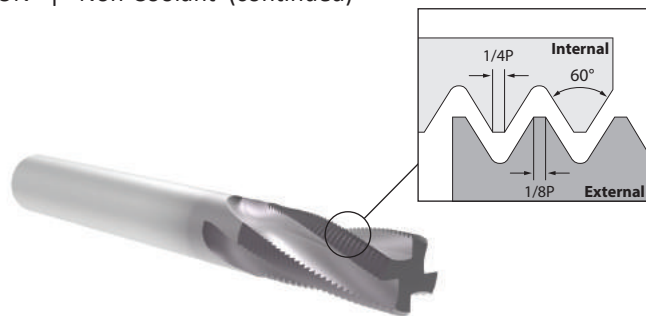

UN | Non-Coolant

TPI (Pitch)	Min Thread Ø	Flutes	Thread Mill				Part No.	
			D ₁	D ₂	L ₆	L ₁	ThreadMills USA	AccuThread™ 856
18	5/16	3	0.235	0.250	0.625	2.500	TM31218	TMUK0313-18
18	5/16	3	0.245	0.312	0.625	3.000	HDTM31218	-
18	9/16	4	0.370	0.375	0.875	3.500	TM56218	TMUK0563-18
16	3/8	4	0.285	0.312	0.750	3.000	TM37516	TMUK0375-16
16	3/8	4	0.300	0.375	0.750	3.500	HDTM37516	-
16	3/4	4	0.490	0.500	1.250	3.500	TM75016	TMUK0750-16
14	7/16	4	0.305	0.312	0.750	3.000	TM43714	TMUK0438-14
14	7/8	4	0.490	0.500	1.250	3.500	TM87514	TMUK0875-14
13	1/2	4	0.350	0.375	0.875	3.500	TM50013	TMUK0500-13
13	1/2	4	0.400	0.500	0.875	3.500	HDTM50013	-
12	9/16	4	0.370	0.375	0.875	3.500	TM56212	TMUK0563-12
i	12	3/4	0.495	0.500	1.250	3.500	TM75012	TMUK0750-12
12	1	6	0.745	0.750	1.500	4.000	TM10012	-
11	5/8	4	0.470	0.500	1.250	3.500	TM62511	TMUK0625-11
11	5/8	4	0.470	0.500	1.455	3.500	TM62511-XL	TMUK0625-11XL
10	3/4	4	0.495	0.500	1.250	3.500	TM75010	TMUK0750-10
10	3/4	4	0.495	0.500	1.600	4.000	TM75010-XL	TMUK0750-10XL
9	7/8	4	0.620	0.625	1.375	4.000	TM87509	TMUK0875-9
9	7/8	4	0.620	0.625	1.778	4.000	TM87509-XL	TMUK0875-9XL
8	1	4	0.620	0.625	1.375	4.000	TM10008	TMUK1000-8
8	1	6	0.745	0.750	2.000	4.500	TM10008-XL	TMUK1000-8XL
7	1-1/8	5	0.745	0.750	1.572	4.500	TM12507	-
6	1-3/8	5	0.745	0.750	1.500	4.500	TM13706	-

E: 46 - 49

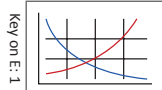

E: 4



Weldon Flat

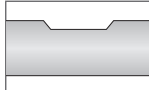

To order a thread mill with a Weldon flat, replace the leading TM designator with TW (available for inch shanks 3/8 and above, or metric shanks 6mm and above)
Example: Cylindrical shank = **TM**NK0500-NPT | Weldon shank flat = **TW**NK0500-NPT
NOTE: Weldon flats have a minimum order quantity of 2 pieces



i = Imperial (in)
 m = Metric (mm)

Solid Carbide Thread Mills

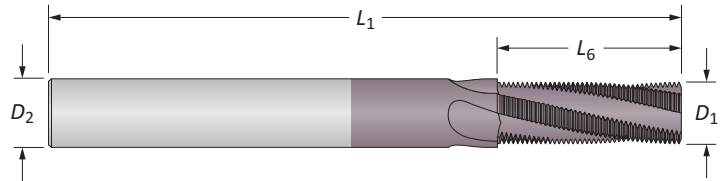
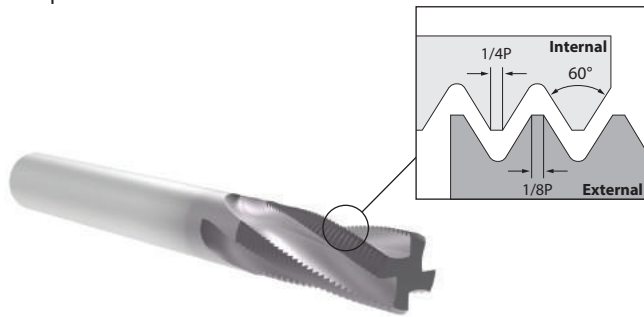
UN | Non-Coolant



UN | Non-Coolant

TPI (Pitch)	Min Thread Ø	Flutes	Thread Mill				Part No.	
			D_1	D_2	L_6	L_1	 ThreadMills USA	 AccuThread™ 856
64	#2	3*	1.65	3.00	3.20	39.00	TM08664M	TMUK0002-64M
56	#2	3*	1.65	3.00	3.20	39.00	TM08656M	TMUK0002-56M
48	#3	3*	1.80	3.00	3.75	39.00	TM09948M	TMUK0003-48M
44	#5	3	2.40	3.00	4.65	39.00	TM12544M	TMUK0005-44M
40	#4	3*	2.20	3.00	4.45	39.00	TM12540M	TMUK0004-40M
36	#8	3	3.00	4.00	6.35	51.00	TM16436M	TMUK0008-36M
32	#6	3	2.50	3.00	5.55	39.00	TM13832M	TMUK0006-32M
32	#8	3	3.20	4.00	6.35	51.00	TM16432M	TMUK0008-32M
32	#10	3	3.80	4.00	7.95	51.00	TM19032M	TMUK0010-32M
32	#10	3	3.80	4.00	7.95	51.00	HDTM19032M	–
32	1/2	6	9.40	10.00	25.40	84.00	TM50032M	–
28	#10	3	3.80	4.00	8.20	51.00	TM19028M	TMUK0010-28M
28	1/4	3	4.75	6.00	12.70	58.00	TM25028M	TMUK0250-28M
28	7/16	4	7.90	8.00	19.95	64.00	–	TMUK0438-28M
28	1/2	6	9.40	10.00	25.40	84.00	TM50028M	–
24	#10	3	3.70	4.00	8.50	51.00	TM19024M	TMUK0010-24M
24	#10	3	3.70	4.00	8.50	51.00	HDTM19024M	TMUK0313-24M
24	5/16	3	5.95	6.00	16.00	58.00	TM31224M	TMUK0375-24M
24	3/8	4	7.25	8.00	19.00	64.00	TM37524M	–
24	1/2	6	9.40	10.00	25.40	84.00	TM50024M	–
20	1/4	3	4.75	6.00	12.70	58.00	TM25020M	TMUK0250-20M
20	1/4	3	4.95	6.00	12.70	58.00	HDTM25020M	–
20	7/16	4	8.75	10.00	22.85	73.00	TM43720M	TMUK0438-20M
20	1/2	6	9.40	10.00	25.40	84.00	TM50020M	–

*Straight fluted

E: 46 - 49

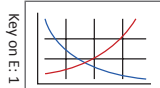

E: 4



Weldon Flat

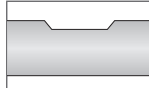

To order a thread mill with a Weldon flat, replace the leading TM designator with TW (available for inch shanks 3/8 and above, or metric shanks 6mm and above)

Example: Cylindrical shank = **TM**NK0500-NPT | Weldon shank flat = **TWN**K0500-NPT

NOTE: Weldon flats have a minimum order quantity of 2 pieces

i = Imperial (in)
m = Metric (mm)



Solid Carbide Thread Mills

UN | Non-Coolant (continued)

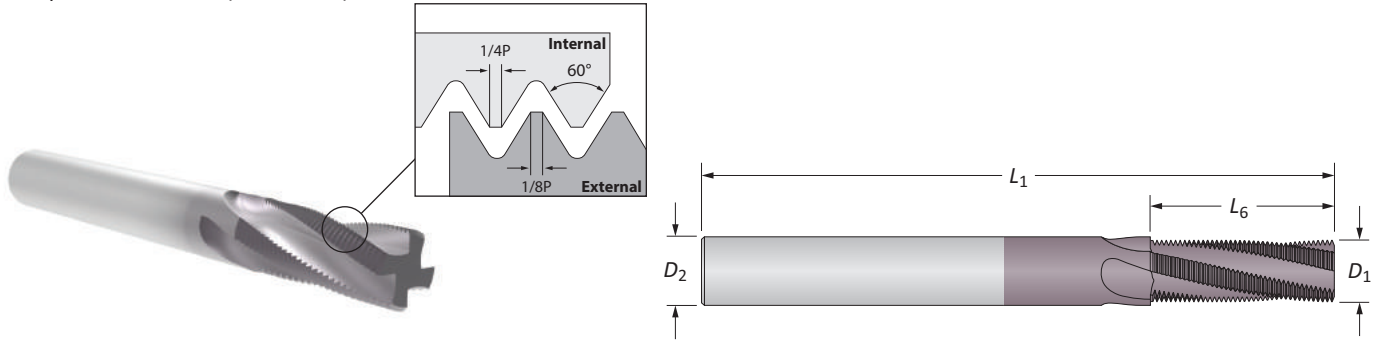

UN | Non-Coolant

TPI (Pitch)	Min Thread Ø	Flutes	Thread Mill				Part No.	
			D ₁	D ₂	L ₆	L ₁	ThreadMills USA	AccuThread™ 856
18	5/16	3	5.95	6.00	17.00	58.00	TM31218M	TMUK0313-18M
18	5/16	3	6.22	8.00	15.87	64.00	HDTM31218M	-
18	9/16	4	9.90	10.00	22.65	73.00	TM56218M	TMUK0563-18M
16	3/8	4	7.25	8.00	19.05	64.00	TM37516M	TMUK0375-16M
16	3/8	4	7.62	10.00	19.05	84.00	HDTM37516M	-
16	3/4	4	11.95	12.00	31.75	84.00	TM75016M	TMUK0750-16M
14	7/16	4	7.75	8.00	20.00	64.00	TM43714M	TMUK0438-14M
14	7/8	4	11.95	12.00	32.70	84.00	TM87514M	TMUK0875-14M
13	1/2	4	9.40	10.00	23.50	73.00	TM50013M	TMUK0500-13M
13	1/2	4	10.16	12.00	23.50	84.00	HDTM50013M	-
12	9/16	4	9.90	10.00	23.35	73.00	TM56212M	TMUK0563-12M
12	3/4	4	11.95	12.00	31.75	84.00	TM75012M	TMUK0750-12M
12	1	6	18.92	20.00	38.10	105.00	TM10012M	-
11	5/8	4	11.95	12.00	32.40	84.00	TM62511M	TMUK0625-11M
11	5/8	4	11.95	12.00	37.00	100.00	TM62511M-XL	TMUK0625-11XLM
10	3/4	4	11.95	12.00	33.00	84.00	TM75010M	TMUK0750-10M
10	3/4	4	11.95	12.00	40.70	100.00	TM75010M-XL	TMUK0750-10XLM
9	7/8	4	15.75	16.00	36.75	93.00	TM87509M	TMUK0875-9M
9	7/8	4	15.75	16.00	45.20	100.00	TM87509M-XL	TMUK0875-9XLM
8	1	4	15.75	16.00	35.00	93.00	TM10008M	TMUK1000-8M
8	1	6	19.90	20.00	50.80	115.00	TM10008M-XL	TMUK1000-8XLM
7	1-1/8	5	19.90	20.00	36.30	105.00	TM12507M	TMUK1125-7M
6	1-3/8	5	19.90	20.00	38.10	105.00	TM13706M	TMUK1375-6M

mm

E: 46 - 49

E: 4

Weldon Flat

To order a thread mill with a Weldon flat, replace the leading TM designator with TW (available for inch shanks 3/8 and above, or metric shanks 6mm and above)
Example: Cylindrical shank = **TM**NK0500-NPT | Weldon shank flat = **TW**NK0500-NPT
NOTE: Weldon flats have a minimum order quantity of 2 pieces

Ⓜ = Imperial (in)
 Ⓜ = Metric (mm)

Solid Carbide Thread Mills

UN | Coolant Through

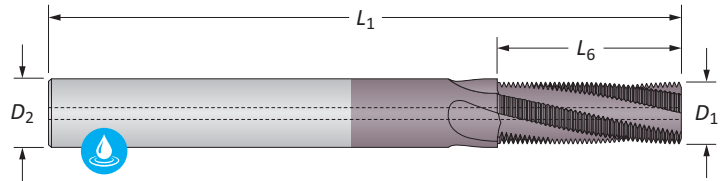
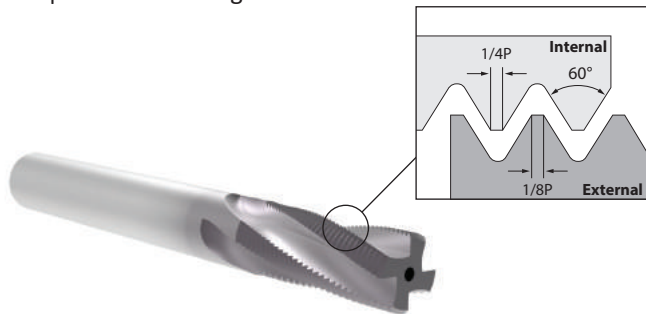

UN | Coolant Through

TPI (Pitch)	Min Thread Ø	Flutes	Thread Mill				Part No.
			D_1	D_2	L_6	L_1	
64	#2	3*	0.065	0.125	0.125	1.500	 TM08664CH
56	#2	3*	0.065	0.125	0.125	1.500	TM08656CH
48	#3	3*	0.075	0.125	0.167	1.500	TM09948CH
44	#5	3	0.095	0.125	0.228	1.500	TM12544CH
40	#4	3*	0.085	0.125	0.175	1.500	TM12540CH
36	#8	3	0.115	0.125	0.250	1.500	TM16436CH
32	#6	3	0.100	0.125	0.218	1.500	TM13832CH
32	#8	3	0.115	0.125	0.250	1.500	TM16432CH
32	#10	3	0.150	0.187	0.312	2.375	TM19032CH
32	#10	3	0.150	0.187	0.312	2.375	HDTM19032CH
32	1/2	6	0.370	0.375	1.000	3.500	TM50032CH
i 28	#10	3	0.120	0.125	0.312	1.500	TM19028CH
28	1/4	3	0.180	0.187	0.500	2.375	TM25028CH
28	1/2	6	0.370	0.375	1.000	3.500	TM50028CH
24	#10	3	0.145	0.187	0.312	2.375	TM19024CH
24	#10	3	0.145	0.187	0.312	2.375	HDTM19024CH
24	5/16	3	0.235	0.250	0.625	2.375	TM31224CH
24	3/8	4	0.285	0.312	0.750	3.000	TM37524CH
24	1/2	6	0.370	0.375	1.000	3.500	TM50024CH
20	1/4	3	0.180	0.187	0.500	2.375	TM25020CH
20	1/4	3	0.195	0.250	0.500	2.375	HDTM25020CH
20	7/16	4	0.335	0.375	0.875	3.000	TM43720CH
20	1/2	6	0.370	0.375	1.000	3.500	TM50020CH

*Straight fluted

E: 46 - 49

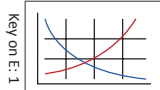

E: 4



Weldon Flat

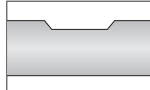

To order a thread mill with a Weldon flat, replace the leading TM designator with TW (available for inch shanks 3/8 and above, or metric shanks 6mm and above)

Example: Cylindrical shank = **TM**NK0500-NPT | Weldon shank flat = **TWNK**0500-NPT

NOTE: Weldon flats have a minimum order quantity of 2 pieces

i = Imperial (in)
m = Metric (mm)

Solid Carbide Thread Mills

UN | Coolant Through (continued)

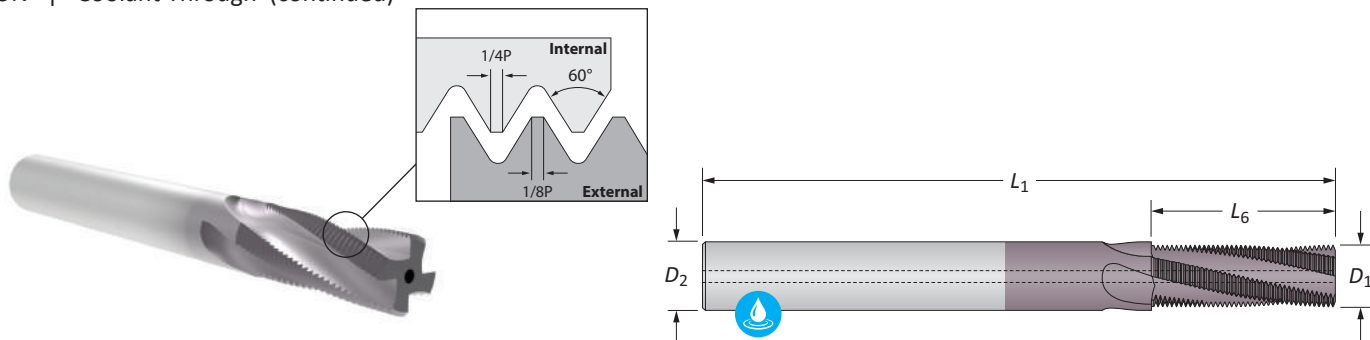

UN | Coolant Through

TPI (Pitch)	Min Thread ϕ	Flutes	Thread Mill				Part No.
			D_1	D_2	L_6	L_1	
18	5/16	3	0.235	0.250	0.625	2.375	TM31218CH
18	5/16	3	0.245	0.312	0.625	3.000	HDTM31218CH
18	9/16	4	0.370	0.375	0.875	3.000	TM56218CH
16	3/8	4	0.285	0.312	0.750	3.000	TM37516CH
16	3/8	4	0.300	0.375	0.750	3.000	HDTM37516CH
16	3/4	4	0.490	0.500	1.250	3.500	TM75016CH
14	7/16	4	0.305	0.312	0.750	3.000	TM43714CH
14	7/8	4	0.490	0.500	1.250	3.500	TM87514CH
13	1/2	4	0.350	0.375	0.875	3.000	TM50013CH
13	1/2	4	0.400	0.500	0.875	3.500	HDTM50013CH
12	9/16	4	0.370	0.375	0.875	3.500	TM56212CH
12	3/4	4	0.495	0.500	1.250	3.500	TM75012CH
12	1	6	0.745	0.750	1.500	4.000	TM10012CH
11	5/8	4	0.470	0.500	1.250	3.500	TM62511CH
11	5/8	4	0.470	0.500	1.455	3.500	TM62511CH-XL
10	3/4	4	0.495	0.500	1.250	3.500	TM75010CH
10	3/4	4	0.495	0.500	1.600	4.000	TM75010CH-XL
9	7/8	4	0.620	0.625	1.375	4.000	TM87509CH
9	7/8	4	0.620	0.625	1.778	4.000	TM87509CH-XL
8	1	4	0.620	0.625	1.375	4.000	TM10008CH
8	1	6	0.745	0.750	2.000	4.500	TM10008CH-XL
7	1-1/8	5	0.745	0.750	1.572	4.500	TM12507CH
6	1-3/8	5	0.745	0.750	1.500	4.500	TM13706CH

i

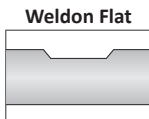
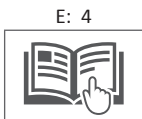
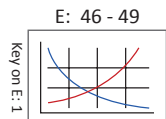

To order a thread mill with a Weldon flat, replace the leading TM designator with TW (available for inch shanks 3/8 and above, or metric shanks 6mm and above)
Example: Cylindrical shank = **TM**NK0500-NPT | Weldon shank flat = **TW**NK0500-NPT
NOTE: Weldon flats have a minimum order quantity of 2 pieces

i = Imperial (in)
m = Metric (mm)

Solid Carbide Thread Mills

UN | Coolant Through

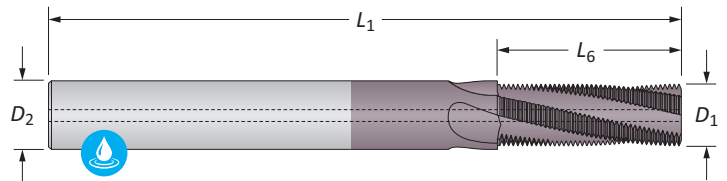
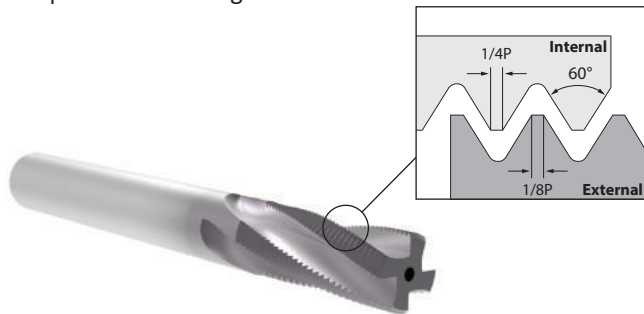

UN | Coolant Through

TPI (Pitch)	Min Thread Ø	Flutes	Thread Mill				Part No.
			D_1	D_2	L_6	L_1	
64	#2	3*	1.65	3.00	3.20	39.00	TM08664CHM
56	#2	3*	1.65	3.00	3.20	39.00	TM08656CHM
48	#3	3*	1.80	3.00	3.75	39.00	TM09948CHM
44	#5	3	2.40	3.00	4.65	39.00	TM12544CHM
40	#4	3*	2.20	3.00	4.45	39.00	TM12540CHM
36	#8	3	3.00	4.00	6.35	51.00	TM16436CHM
32	#6	3	2.50	3.00	5.55	39.00	TM13832CHM
32	#8	3	3.20	4.00	6.35	51.00	TM16432CHM
32	#10	3	3.80	4.00	7.95	51.00	TM19032CHM
32	#10	3	3.80	4.00	7.95	51.00	HDTM19032CHM
32	1/2	6	9.40	10.00	25.40	84.00	TM50032CHM
M 28	#10	3	3.80	4.00	8.20	51.00	TM19028CHM
28	1/4	3	4.75	6.00	12.70	58.00	TM25028CHM
28	1/2	6	9.40	10.00	25.40	84.00	TM50028CHM
24	#10	3	3.68	4.00	8.50	51.00	TM19024CHM
24	#10	3	3.70	4.00	8.50	51.00	HDTM19024CHM
24	5/16	3	5.95	6.00	16.00	58.00	TM31224CHM
24	3/8	4	7.25	8.00	19.00	64.00	TM37524CHM
24	1/2	6	9.40	10.00	25.40	84.00	TM50024CHM
20	1/4	3	4.75	6.00	12.70	58.00	TM25020CHM
20	1/4	3	4.95	6.00	12.70	58.00	HDTM25020CHM
20	7/16	4	8.75	10.00	22.85	84.00	TM43720CHM
20	1/2	6	9.40	10.00	25.40	84.00	TM50020CHM

*Straight fluted

E: 46 - 49

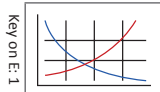

E: 4



Weldon Flat

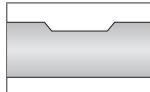

To order a thread mill with a Weldon flat, replace the leading TM designator with TW (available for inch shanks 3/8 and above, or metric shanks 6mm and above)

Example: Cylindrical shank = **TM**NK0500-NPT | Weldon shank flat = **TW**NK0500-NPT

NOTE: Weldon flats have a minimum order quantity of 2 pieces

i = Imperial (in)
m = Metric (mm)

Solid Carbide Thread Mills

UN | Coolant Through (continued)

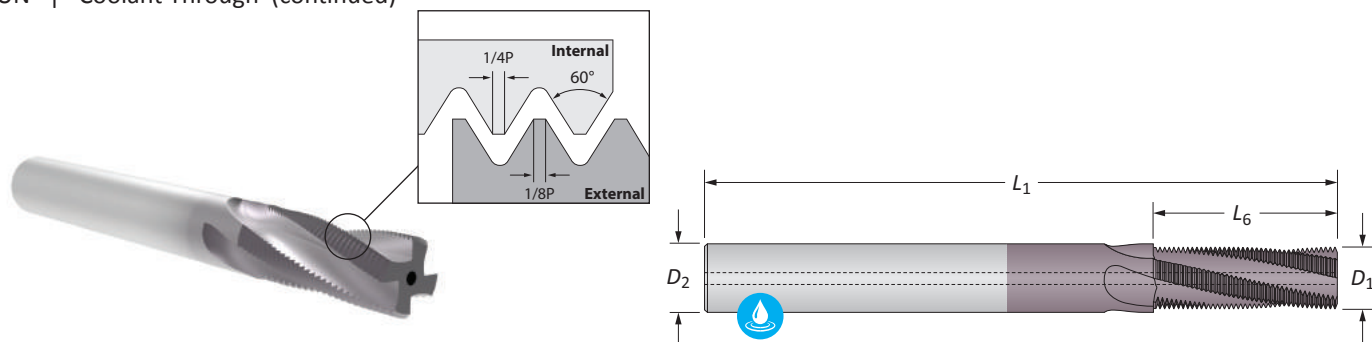

UN | Coolant Through

TPI (Pitch)	Min Thread ϕ	Flutes	Thread Mill				Part No.
			D_1	D_2	L_6	L_1	
18	5/16	3	5.95	6.00	17.00	58.00	TM31218CHM
18	5/16	3	6.22	8.00	15.87	64.00	HDTM31218CHM
18	9/16	4	9.90	10.00	22.65	84.00	TM56218CHM
16	3/8	4	7.25	8.00	19.05	64.00	TM37516CHM
16	3/8	4	7.62	10.00	19.05	84.00	HDTM37516CHM
16	3/4	4	11.95	12.00	31.75	84.00	TM75016CHM
14	7/16	4	7.75	8.00	20.00	64.00	TM43714CHM
14	7/8	4	11.95	12.00	32.70	84.00	TM87514CHM
13	1/2	4	9.40	10.00	23.50	84.00	TM50013CHM
13	1/2	4	10.16	12.00	23.50	84.00	HDTM50013CHM
12	9/16	4	9.90	10.00	23.35	84.00	TM56212CHM
12	3/4	4	11.95	12.00	31.75	84.00	TM75012CHM
12	1	6	18.92	20.00	38.10	105.00	TM10012CHM
11	5/8	4	11.95	12.00	32.40	84.00	TM62511CHM
11	5/8	4	11.95	12.00	37.00	100.00	TM62511CHM-XL
10	3/4	4	11.95	12.00	33.00	84.00	TM75010CHM
10	3/4	4	11.95	12.00	40.70	100.00	TM75010CHM-XL
9	7/8	4	15.75	16.00	36.75	93.00	TM87509CHM
9	7/8	4	15.75	16.00	45.20	100.00	TM87509CHM-XL
8	1	4	15.75	16.00	35.00	93.00	TM10008CHM
8	1	6	19.90	20.00	50.80	115.00	TM10008CHM-XL
7	1-1/8	5	19.90	20.00	36.10	105.00	TM12507CHM
6	1-3/8	5	19.90	20.00	38.10	105.00	TM13706CHM

Ⓜ

E: 46 - 49

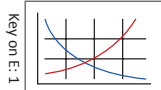

E: 4



Weldon Flat

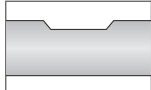

To order a thread mill with a Weldon flat, replace the leading TM designator with TW (available for inch shanks 3/8 and above, or metric shanks 6mm and above)
Example: Cylindrical shank = **TM**NK0500-NPT | Weldon shank flat = **TW**NK0500-NPT
NOTE: Weldon flats have a minimum order quantity of 2 pieces



Ⓜ = Imperial (in)
 Ⓜ = Metric (mm)

Solid Carbide Thread Mills

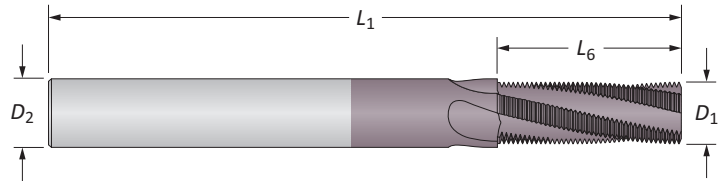
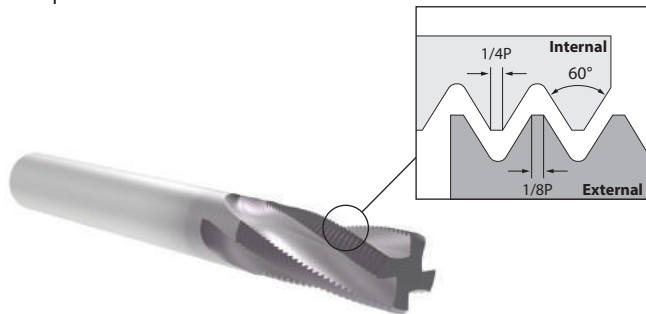
ISO | Non-Coolant



ISO | Non-Coolant

Pitch	Min Thread Ø	Flutes	Thread Mill				Part No.	
			D_1	D_2	L_6	L_1	 ThreadMills USA	 AccuThread™ 856
0.40	M2	3*	0.059	0.125	0.126	2.000	TM20040	–
0.45	M2.5	3*	0.059	0.125	0.142	2.000	TM25045	–
0.50	M3	3*	0.085	0.125	0.178	2.000	TM30050	–
0.50	M6	3	0.181	0.187	0.473	2.500	TM60050	–
0.50	M10	4	0.310	0.312	0.591	3.000	TM10050	–
0.70	M4	3	0.115	0.125	0.276	2.000	TM40070	–
0.75	M4.5	3	0.120	0.125	0.266	2.000	TM45075	TMMK0450-075
0.75	M8	3	0.235	0.250	0.625	2.500	TM80075	TMMK0800-075
0.75	M10	4	0.310	0.312	0.591	3.000	TM10075	–
0.80	M5	3	0.120	0.125	0.312	2.000	TM50080	TMMK0500-080
1.00	M6	3	0.170	0.187	0.500	2.500	TM60100	TMMK0600-100
1.00	M12	4	0.360	0.375	0.875	3.500	TM12100	TMMK1200-100
1.25	M8	3	0.235	0.250	0.625	2.500	TM80125	TMMK0800-125
1.50	M10	4	0.300	0.312	0.750	3.000	TM10150	TMMK1000-150
1.50	M14	4	0.370	0.375	0.875	3.500	TM14150	TMMK1400-150
1.50	M18	4	0.490	0.500	1.250	3.500	TM18150	TMMK1800-150
1.50	M20	5	0.620	0.625	1.418	4.000	TM20150	–
1.75	M12	4	0.360	0.375	0.875	3.500	TM12175	TMMK1200-175
2.00	M14	4	0.429	0.500	1.103	3.500	TM14200	–
2.00	M16	4	0.470	0.500	1.250	3.500	TM16200	TMMK1600-200
2.50	M20	4	0.495	0.500	1.250	3.500	TM20250	TMMK2000-250
3.00	M24	4	0.620	0.625	1.375	4.000	TM24300	TMMK2400-300
3.50	M30	4	0.620	0.625	1.516	4.000	TM30350	–
4.00	M36	5	0.745	0.750	1.575	4.500	TM36400	–

*Straight fluted

E: 46 - 49

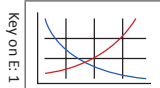

E: 4



Weldon Flat

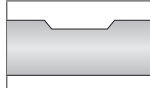

To order a thread mill with a Weldon flat, replace the leading TM designator with TW (available for inch shanks 3/8 and above, or metric shanks 6mm and above)

Example: Cylindrical shank = **TW**NK0500-NPT | Weldon shank flat = **TWN**K0500-NPT

NOTE: Weldon flats have a minimum order quantity of 2 pieces

i = Imperial (in)

m = Metric (mm)



Solid Carbide Thread Mills

ISO | Coolant Through

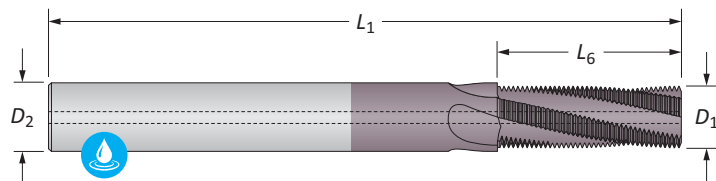
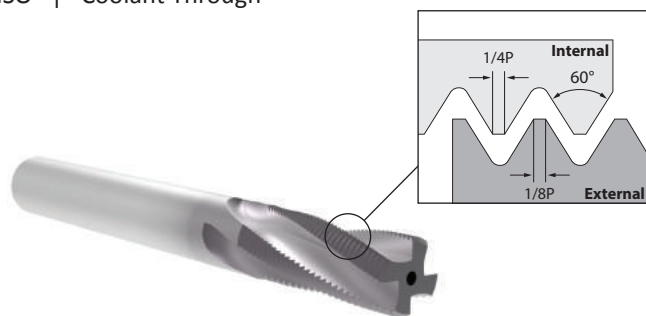

ISO | Coolant Through

Pitch	Min Thread ϕ	Flutes	Thread Mill				Part No.
			D_1	D_2	L_6	L_1	
0.40	M2	3*	0.059	0.125	0.126	1.500	TM20040CH
0.45	M2.5	3*	0.059	0.125	0.142	1.500	TM25045CH
0.50	M3	3*	0.085	0.125	0.178	1.500	TM30050CH
0.50	M6	3	0.181	0.187	0.473	2.375	TM60050CH
0.50	M10	4	0.310	0.312	0.591	3.000	TM10050CH
0.70	M4	3	0.115	0.125	0.276	1.500	TM40070CH
0.75	M4.5	3	0.120	0.125	0.266	1.500	TM45075CH
0.75	M8	3	0.235	0.250	0.625	2.375	TM80075CH
0.75	M10	4	0.310	0.312	0.591	3.000	TM10075CH
0.80	M5	3	0.120	0.125	0.312	1.500	TM50080CH
1.00	M6	3	0.170	0.187	0.500	2.375	TM60100CH
1.00	M12	4	0.360	0.375	0.875	3.000	TM12100CH
1.25	M8	3	0.235	0.250	0.625	2.375	TM80125CH
1.50	M10	4	0.300	0.312	0.750	3.000	TM10150CH
1.50	M14	4	0.370	0.375	0.875	3.000	TM14150CH
1.50	M18	4	0.490	0.500	1.250	3.500	TM18150CH
1.50	M20	5	0.620	0.625	1.418	4.000	TM20150CH
1.75	M12	4	0.360	0.375	0.875	3.000	TM12175CH
2.00	M14	4	0.429	0.500	1.103	3.500	TM14200CH
2.00	M16	4	0.470	0.500	1.250	3.500	TM16200CH
2.50	M20	4	0.495	0.500	1.250	3.500	TM20250CH
3.00	M24	4	0.620	0.625	1.375	4.000	TM24300CH
3.50	M30	4	0.620	0.625	1.516	4.000	TM30350CH
4.00	M36	5	0.745	0.750	1.575	4.500	TM36400CH

*Straight fluted

E: 46 - 49

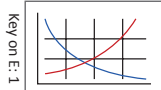

E: 4



Weldon Flat

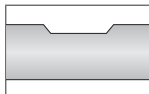

To order a thread mill with a Weldon flat, replace the leading TM designator with TW (available for inch shanks 3/8 and above, or metric shanks 6mm and above)
Example: Cylindrical shank = **TM**NK0500-NPT | Weldon shank flat = **TW**NK0500-NPT
NOTE: Weldon flats have a minimum order quantity of 2 pieces

i = Imperial (in)
m = Metric (mm)

Solid Carbide Thread Mills

ISO | Non-Coolant

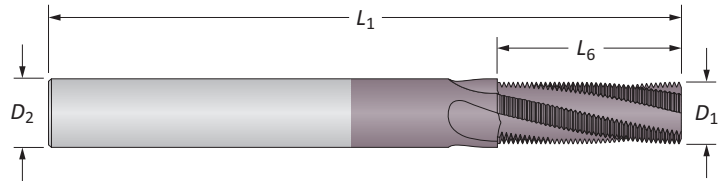
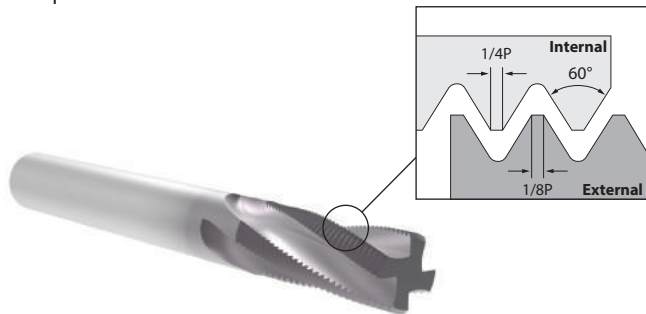

ISO | Non-Coolant

Pitch	Min Thread \varnothing	Flutes	Thread Mill				Part No.	
			D_1	D_2	L_6	L_1	ThreadMills USA	AccuThread™ 856
0.40	M2	3*	1.50	3.00	3.20	39.00	TM20040M	TMMK0200-040M
0.45	M2.5	3*	1.50	3.00	3.60	39.00	TM25045M	TMMK0250-045M
0.50	M3	3*	2.15	3.00	4.50	39.00	TM30050M	TMMK0300-050M
0.50	M6	3	4.60	6.00	12.00	58.00	TM60050M	TMMK0600-050M
0.50	M10	4	7.95	8.00	15.00	64.00	TM10050M	TMMK1000-050M
0.70	M4	3	2.90	3.00	8.00	39.00	TM40070M	TMMK0400-070M
0.75	M4.5	3	3.00	4.00	6.75	51.00	TM45075M	TMMK0450-075M
0.75	M6	3	4.60	6.00	12.00	58.00	TM60075M	TMMK0600-075M
0.75	M10	4	7.95	8.00	15.00	64.00	TM10075M	TMMK1000-075M
0.80	M5	3	3.60	4.00	8.00	51.00	TM50080M	TMMK0500-080M
1.00	M6	3	4.60	6.00	12.00	58.00	TM60100M	TMMK0600-100M
1.00	M12	4	9.40	10.00	20.00	73.00	TM12100M	TMMK1200-100M
1.25	M8	3	5.90	6.00	16.25	58.00	TM80125M	TMMK0800-125M
1.50	M10	4	7.40	8.00	19.50	64.00	TM10150M	TMMK1000-150M
1.50	M14	4	10.90	12.00	27.00	84.00	TM14150M	TMMK1400-150M
1.50	M18	4	11.90	12.00	31.50	84.00	TM18150M	TMMK1800-150M
1.50	M20	5	15.75	16.00	36.00	93.00	TM20150M	-
1.75	M12	4	9.40	10.00	22.71	73.00	TM12175M	TMMK1200-175M
2.00	M14	4	10.90	12.00	28.00	84.00	TM14200M	TMMK1400-200M
2.00	M16	4	11.95	12.00	30.00	84.00	TM16200M	TMMK2000-200M
2.50	M20	4	11.90	12.00	30.00	84.00	TM20250M	TMMK2000-250M
3.00	M24	4	15.90	16.00	36.00	93.00	TM24300M	TMMK2400-300M
3.50	M30	4	15.75	16.00	38.50	100.00	TM30350M	TMMK3000-350M
4.00	M36	5	19.90	20.00	40.00	105.00	TM36400M	TMMK3600-400M

*Straight fluted

E: 46 - 49

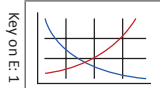

Key on E: 1

E: 4



Weldon Flat

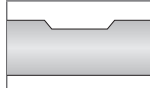

To order a thread mill with a Weldon flat, replace the leading TM designator with TW (available for inch shanks 3/8 and above, or metric shanks 6mm and above)

Example: Cylindrical shank = **TM**NK0500-NPT | Weldon shank flat = **TWN**K0500-NPT

NOTE: Weldon flats have a minimum order quantity of 2 pieces

i = Imperial (in)

m = Metric (mm)



Solid Carbide Thread Mills

ISO | Coolant Through

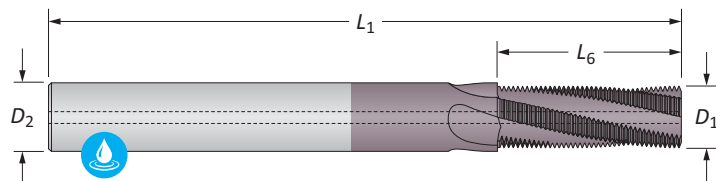
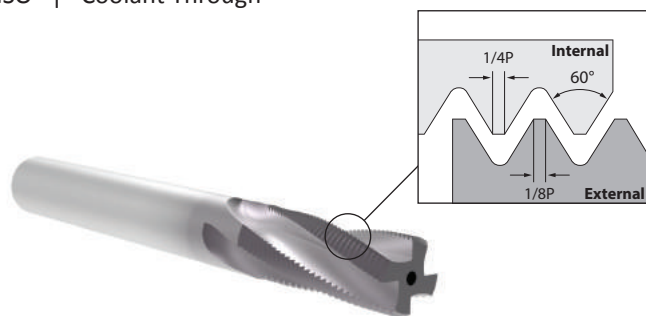

ISO | Coolant Through

Pitch	Min Thread ϕ	Flutes	Thread Mill				Part No.
			D_1	D_2	L_6	L_1	ThreadMills USA
0.40	M2	3*	1.50	3.00	3.20	39.00	TM20040CHM
0.45	M2.5	3*	1.50	3.00	3.60	39.00	TM25045CHM
0.50	M3	3*	2.15	3.00	4.50	39.00	TM30050CHM
0.50	M6	3	4.60	6.00	12.00	58.00	TM60050CHM
0.50	M10	4	7.95	8.00	15.00	64.00	TM10050CHM
0.70	M4	3	2.90	3.00	8.00	39.00	TM40070CHM
0.75	M4.5	3	3.00	4.00	6.75	51.00	TM45075CHM
0.75	M6	3	4.60	6.00	12.00	58.00	TM60075CHM
0.75	M10	4	7.95	8.00	15.00	64.00	TM10075CHM
0.80	M5	3	3.60	4.00	8.00	51.00	TM50080CHM
1.00	M6	3	4.60	6.00	12.00	58.00	TM60100CHM
1.00	M12	4	9.40	10.00	20.00	84.00	TM12100CHM
1.25	M8	3	5.90	6.00	16.25	58.00	TM80125CHM
1.50	M10	4	7.40	8.00	19.50	64.00	TM10150CHM
1.50	M14	4	10.90	12.00	27.00	84.00	TM14150CHM
1.50	M18	4	11.90	12.00	31.50	84.00	TM18150CHM
1.50	M20	5	15.75	16.00	36.00	93.00	TM20150CHM
1.75	M12	4	9.40	10.00	22.71	84.00	TM12175CHM
2.00	M14	4	10.90	12.00	28.00	84.00	TM14200CHM
2.00	M16	4	11.95	12.00	30.00	84.00	TM16200CHM
2.50	M20	4	11.90	12.00	30.00	84.00	TM20250CHM
3.00	M24	4	15.90	16.00	36.00	93.00	TM24300CHM
3.50	M30	4	15.75	16.00	38.50	100.00	TM30350CHM
4.00	M36	5	19.90	20.00	40.00	105.00	TM36400CHM

*Straight fluted

E: 46 - 49

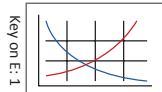

E: 4



Weldon Flat

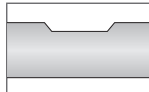

To order a thread mill with a Weldon flat, replace the leading TM designator with TW (available for inch shanks 3/8 and above, or metric shanks 6mm and above)
Example: Cylindrical shank = **TM**NK0500-NPT | Weldon shank flat = **TW**NK0500-NPT
NOTE: Weldon flats have a minimum order quantity of 2 pieces

I = Imperial (in)
M = Metric (mm)

Indexable Insert Thread Mills Overview

A DRILLING
B BORING
C REAMING
D BURNISHING
E THREADING
X SPECIALS



Bolt-in Style

- Replaceable inserts allow for quick set-ups and tool changes to keep the production process moving smoothly
- Inserts are available with AM210® coating, which increases tool life
- Available with 1 flute only
- Multiple thread form styles are available
- Tapered thread forms: NPT, NPTF, BSPT
- Straight thread forms: BSPP, UN, UNJ, ISO

Bolt-in Style Indexable Thread Mill Assembly



Step 1:
Slide the thread mill insert into the insert holder slot.

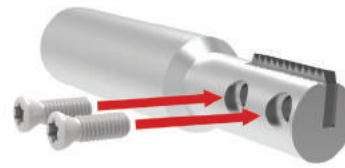

Step 2:
Tighten the screws to hold the insert in place.

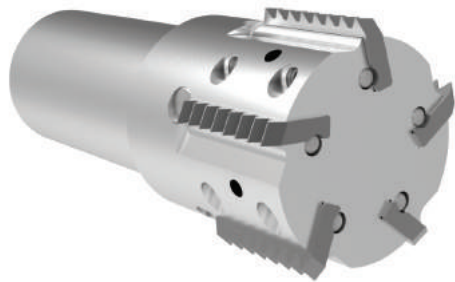

Pin Style

- Replaceable inserts allow for quick set-ups and tool changes to keep the production process moving smoothly
- Inserts are available with AM210® coating, which increases tool life
- Holders available in 2 styles: Weldon Shank and Shell Mill
- Weldon Shank holders available with 1, 2, 3, and 5 flutes
- Shell Mill holders available with 6, 7, and 8 flutes
- Thread forms available: NPT, NPTF, BSPT, BSPP, API-ROUND, ACME, UN, UNJ, ISO

Pin Style Indexable Thread Mill Assembly

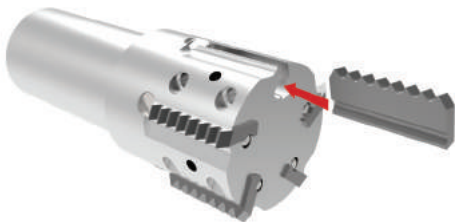

Step 1:
Slide the thread mill insert into the insert holder slot.

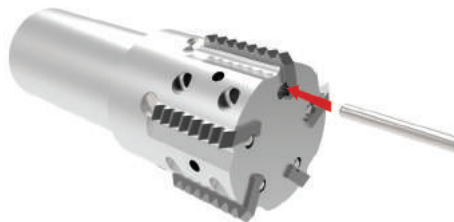

Step 2:
Slide the pin into the pin holder slot to hold the insert in place.

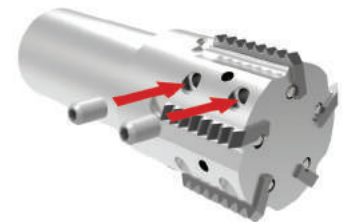

Step 3:
Tighten the screws to hold both the insert and pin in place.

Product Nomenclature

AccuThread™ 856 Indexable Inserts

TP	075	K	-	UN	32	I
1	2	3		4	5	6

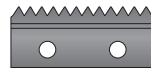

Bolt-in Style

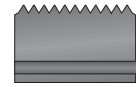

Pin Style

1. Insert Style	2. Insert Length	3. Coating	4. Thread Class	5. Thread Pitch	6. Thread Style
TP = Bolt-in TN = Pin style	075 = 3/4 100 = 1.00 150 = 1.50	K = AM210® A = TiAlN U = Uncoated	UN = UN BSPT = BSPT UNJ = UNJ M = ISO NPT = NPT FA = Full ACME NPTF = NPTF AP = API Round BSPP = BSPP	20 = UN 1.0 = ISO	I = Internal E = External

Indexable Inserts

Symbol	Attribute
L_6	Length of insert
T_1	Insert thickness

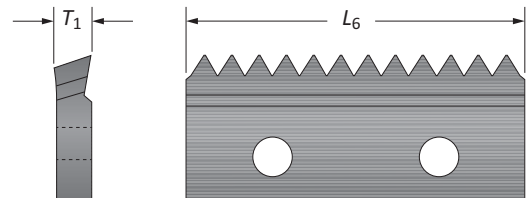

AccuThread™ 856 Indexable Insert Holders

THT	-	0400	-	1F	075	M
1		2		3	4	5

1. Holder Style	
Bolt-in Style	Pin Style
THT = Tapered Head	THP = Weldon Positive Rake
THN = Straight Head	TNR = Weldon Neutral Rake
	TSN = Shell Mill Positive Rake
	TSR = Shell Mill Neutral Rake

2. Length of Insert	3. Shank Designation
0400 = 0.400	1F = 1 flute 6F = 6 flutes 2F = 2 flutes 7F = 7 flutes 3F = 3 flutes 8F = 8 flutes 5F = 5 flutes

4. Length of Insert	5. Shank Designation
075 = 3/4 100 = 1.00 150 = 1.50	Blank = Inch M = Metric

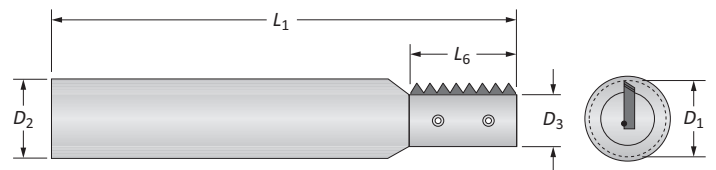

Bolt-in Style Holders

Symbol	Attribute	Symbol	Attribute
D_1	Maximum cutter diameter	L_1	Overall length
D_2	Shank diameter	L_6	Length of insert
D_3	Pilot diameter		

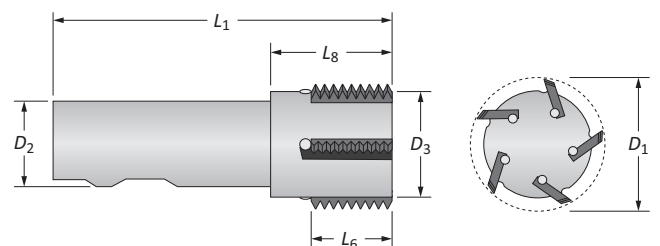

Pin Style Holders

Symbol	Attribute	Symbol	Attribute
D_1	Cutter diameter	D_5	Bore diameter (Shell Mill)
D_1^*	Oversized cutter diameter	L_1	Overall length
D_2	Shank diameter	L_6	Length of insert
D_3	Pilot diameter	L_8	Flute length
D_4	Body diameter (Shell Mill)	T_2	Slot width (Shell Mill)

AccuThread™ 856 Thread Mill Inserts

Bolt-in Style | NPT / NPTF

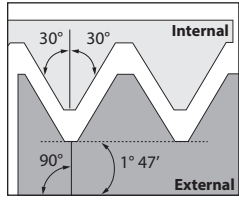

NPT
Internal / External

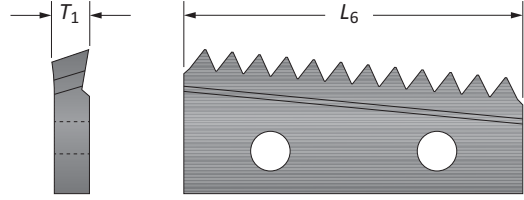

TPI (Pitch)	Insert				Part No.
	L_6 inch	L_6 mm	T_1 inch	T_1 mm	NPT Internal/External
18	0.750	19.05	0.080	2.03	TP075K-NPT18
14	1.000	25.40	0.140	3.56	TP100K-NPT14

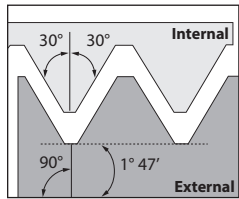

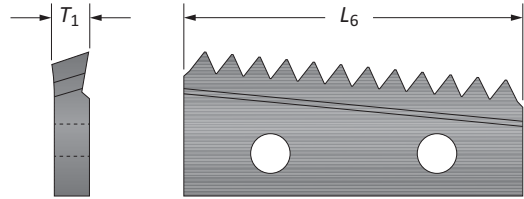

NPTF
Internal / External

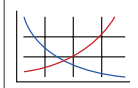

TPI (Pitch)	Insert				Part No.
	L_6 inch	L_6 mm	T_1 inch	T_1 mm	NPTF Internal/External
18	0.750	19.05	0.080	2.03	TP075K-NPTF18
14	1.000	25.40	0.140	3.56	TP100K-NPTF14

E: 50 - 53 E: 28 E: 35

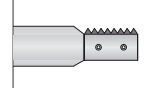





Inserts sold in quantities of 2

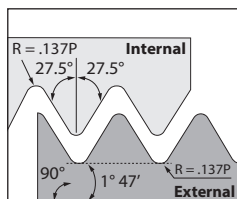

AccuThread™ 856 Thread Mill Inserts

Bolt-in Style | BSPT / BSPP



BSPT
Internal / External

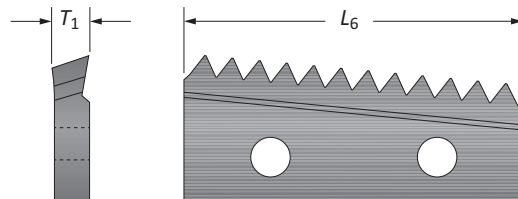

TPI (Pitch)	Insert				Part No.
	L_6 inch	L_6 mm	T_1 inch	T_1 mm	BSPT Internal/External
19	0.750	19.05	0.080	2.03	TP075K-BSPT19
19	1.000	25.40	0.140	3.56	TP100K-BSPT19
14	1.000	25.40	0.140	3.56	TP100K-BSPT14

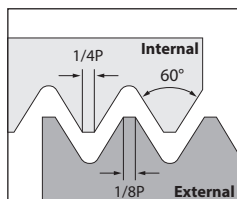

BSPP
Internal / External

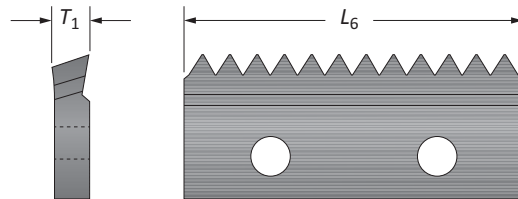

TPI (Pitch)	Insert				Part No.
	L_6 inch	L_6 mm	T_1 inch	T_1 mm	BSPP Internal/External
19	0.750	19.05	0.080	2.03	TP075K-BSPP19
19	1.000	25.40	0.140	3.56	TP100K-BSPP19
14	1.000	25.40	0.140	3.56	TP100K-BSPP14

A

DRILLING

B

BORING

C

REAMING

D

BURNISHING

E

THREADING

X

SPECIALS

E: 50 - 53 E: 28 E: 35

Inserts sold in quantities of 2

AccuThread™ 856 Thread Mill Inserts

Bolt-in Style | UN

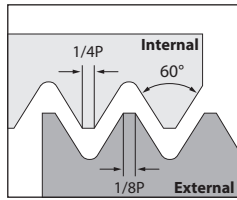

UN
Internal

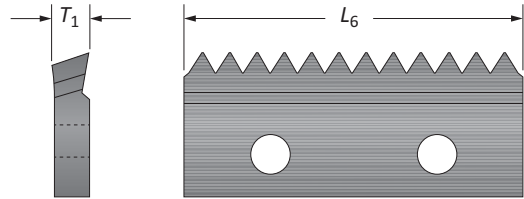

TPI (Pitch)	Insert				Part No. UN Internal
	L ₆ inch	L ₆ mm	T ₁ inch	T ₁ mm	
32	0.750	19.05	0.080	2.03	TP075K-UN32I
32	1.000	25.40	0.140	3.56	TP100K-UN32I
24	0.750	19.05	0.080	2.03	TP075K-UN24I
24	1.000	25.40	0.140	3.56	TP100K-UN24I
20	0.750	19.05	0.080	2.03	TP075K-UN20I
20	1.000	25.40	0.140	3.56	TP100K-UN20I
18	0.750	19.05	0.080	2.03	TP075K-UN18I
18	1.000	25.40	0.140	3.56	TP100K-UN18I
16	0.750	19.05	0.080	2.03	TP075K-UN16I
16	1.000	25.40	0.140	3.56	TP100K-UN16I
14	1.000	25.40	0.140	3.56	TP100K-UN14I
13	1.000	25.40	0.140	3.56	TP100K-UN13I
12	1.000	25.40	0.140	3.56	TP100K-UN12I
10*	1.000	25.40	0.140	3.56	TP100K-UN10I

*This item is only used with THN-0611-1F100 or THN-0611-1F100M. The reduced body allows a 3/4"-10 UN/UNJ to be produced.

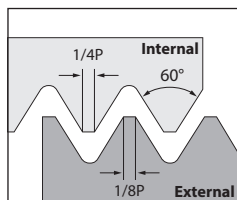

UN
External

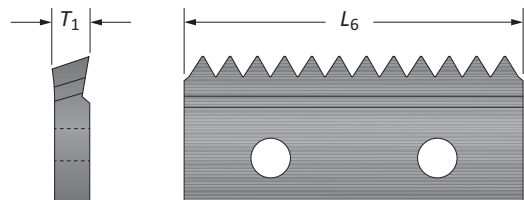

TPI (Pitch)	Insert				Part No. UN External
	L ₆ inch	L ₆ mm	T ₁ inch	T ₁ mm	
32	0.750	19.05	0.080	2.03	TP075K-UN32E
32	1.000	25.40	0.140	3.56	TP100K-UN32E
24	0.750	19.05	0.080	2.03	TP075K-UN24E
24	1.000	25.40	0.140	3.56	TP100K-UN24E
20	0.750	19.05	0.080	2.03	TP075K-UN20E
20	1.000	25.40	0.140	3.56	TP100K-UN20E
18	0.750	19.05	0.080	2.03	TP075K-UN18E
18	1.000	25.40	0.140	3.56	TP100K-UN18E
16	0.750	19.05	0.080	2.03	TP075K-UN16E
16	1.000	25.40	0.140	3.56	TP100K-UN16E
14	1.000	25.40	0.140	3.56	TP100K-UN14E
13	1.000	25.40	0.140	3.56	TP100K-UN13E
12	1.000	25.40	0.140	3.56	TP100K-UN12E
10*	1.000	25.40	0.140	3.56	TP100K-UN10E

*This item is only used with THN-0611-1F100 or THN-0611-1F100M. The reduced body allows a 3/4"-10 UN/UNJ to be produced.

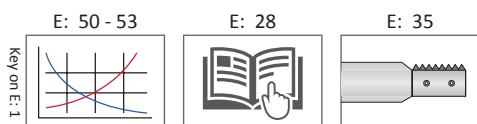

Inserts sold in quantities of 2



AccuThread™ 856 Thread Mill Inserts

Bolt-in Style | UNJ

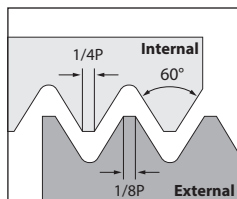

UNJ
Internal

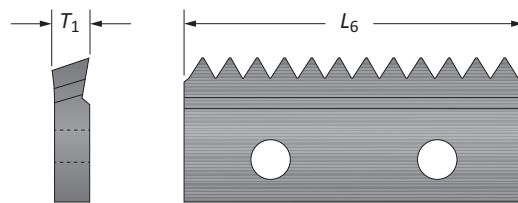

TPI (Pitch)	Insert				Part No.
	L ₆ inch	L ₆ mm	T ₁ inch	T ₁ mm	UNJ Internal
32	0.750	19.05	0.080	2.03	TP075K-UNJ32I
32	1.000	25.40	0.140	3.56	TP100K-UNJ32I
24	0.750	19.05	0.080	2.03	TP075K-UNJ24I
24	1.000	25.40	0.140	3.56	TP100K-UNJ24I
20	0.750	19.05	0.080	2.03	TP075K-UNJ20I
20	1.000	25.40	0.140	3.56	TP100K-UNJ20I
18	0.750	19.05	0.080	2.03	TP075K-UNJ18I
18	1.000	25.40	0.140	3.56	TP100K-UNJ18I
16	0.750	19.05	0.080	2.03	TP075K-UNJ16I
16	1.000	25.40	0.140	3.56	TP100K-UNJ16I
14	1.000	25.40	0.140	3.56	TP100K-UNJ14I
12	1.000	25.40	0.140	3.56	TP100K-UNJ12I
10*	1.000	25.40	0.140	3.56	TP100K-UNJ10I

*This item is only used with THN-0611-1F100 or THN-0611-1F100M. The reduced body allows a 3/4"-10 UN/UNJ to be produced.

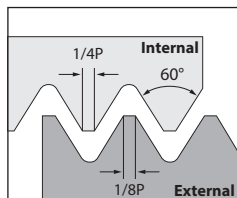

UNJ
External

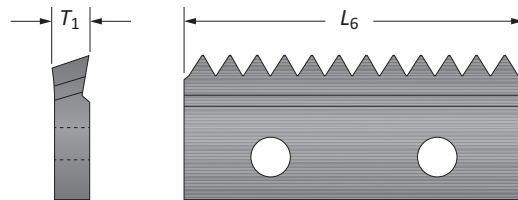

TPI (Pitch)	Insert				Part No.
	L ₆ inch	L ₆ mm	T ₁ inch	T ₁ mm	UNJ External
32	0.750	19.05	0.080	2.03	TP075K-UNJ32E
32	1.000	25.40	0.140	3.56	TP100K-UNJ32E
24	0.750	19.05	0.080	2.03	TP075K-UNJ24E
24	1.000	25.40	0.140	3.56	TP100K-UNJ24E
20	0.750	19.05	0.080	2.03	TP075K-UNJ20E
20	1.000	25.40	0.140	3.56	TP100K-UNJ20E
18	0.750	19.05	0.080	2.03	TP075K-UNJ18E
18	1.000	25.40	0.140	3.56	TP100K-UNJ18E
16	0.750	19.05	0.080	2.03	TP075K-UNJ16E
16	1.000	25.40	0.140	3.56	TP100K-UNJ16E
12	1.000	25.40	0.140	3.56	TP100K-UNJ12E

E: 50 - 53

E: 28

E: 35

Key on E: 1

Inserts sold in quantities of 2

A DRILLING
B BORING
C REAMING
D BURNISHING
E THREADING
X SPECIALS

AccuThread™ 856 Thread Mill Inserts

Bolt-in Style | ISO

A
DRILLING

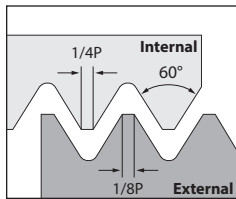

ISO
Internal

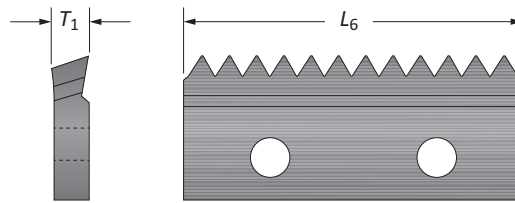

B
BORING

Pitch	Insert				Part No.
	L_6 inch	L_6 mm	T_1 inch	T_1 mm	ISO Internal
0.5	0.750	19.05	0.080	2.03	TP075K-M0.5I
1.0	0.750	19.05	0.080	2.03	TP075K-M1.0I
1.0	1.000	24.40	0.140	3.56	TP100K-M1.0I
1.25	0.750	19.05	0.080	2.03	TP075K-M1.25I
1.5	0.750	19.05	0.080	2.03	TP075K-M1.5I
1.5	1.000	25.40	0.140	3.56	TP100K-M1.5I
2.0	1.000	25.40	0.140	3.56	TP100K-M2.0I

C
REAMING

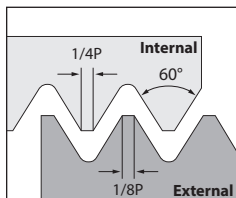

ISO
External

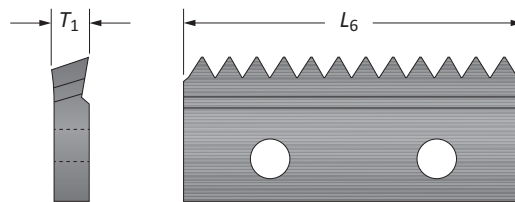

D
BURNISHING

Pitch	Insert				Part No.
	L_6 inch	L_6 mm	T_1 inch	T_1 mm	ISO External
1.0	1.000	24.40	0.140	3.56	TP100K-M1.0E
1.5	1.000	25.40	0.140	3.56	TP100K-M1.5E
2.0	1.000	25.40	0.140	3.56	TP100K-M2.0E

E
THREADING

X
SPECIALS

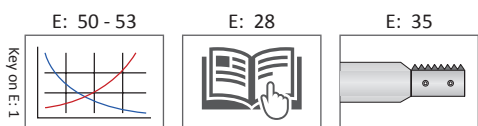

Inserts sold in quantities of 2

AccuThread™ 856 Thread Mill Insert Holders

Bolt-in Style

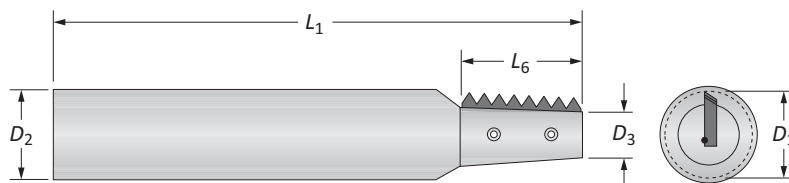

Tapered Insert Holders | NPT / NPTF / BSPT

	Holder					Flutes	Part No.	Inserts	Screw	Wrench
	D_1	D_3	D_2	L_6	L_1					
i	0.400	0.229	0.500	0.750	3.000	1	THT-0400-1F075	TP075K...	TMS-250	8T-8
	0.659	0.379	0.500	1.000	3.000	1	THT-0659-1F100	TP100K...	TMS-45	8T-9
m	10.16	5.82	13.00	19.05	76.20	1	THT-0400-1F075M	TP075K...	TMS-250	8T-8
	16.74	9.65	13.00	25.40	76.20	1	THT-0659-1F100M	TP100K...	TMS-45	8T-9

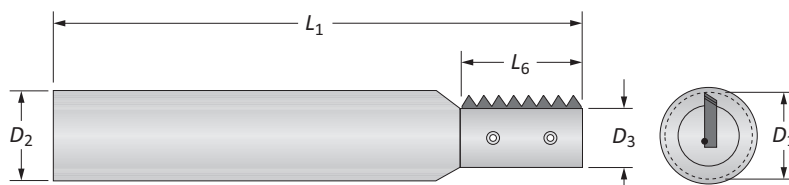

Straight Insert Holders | BSPP / UN / UNJ / ISO

	Holder					Flutes	Part No.	Inserts	Screw	Wrench
	D_1	D_3	D_2	L_6	L_1					
i	0.394	0.250	0.500	0.750	3.000	1	THN-0394-1F075	TP075K...	TMS-250	8T-8
	0.611	0.383	0.750	1.000	3.500	1	THN-0611-1F100	TP100K...	TMS-40	8T-9
	0.625	0.454	0.750	1.000	3.500	1	THN-0625-1F100	TP100K...	TMS-40	8T-9
m	10.01	6.35	13.00	19.05	76.20	1	THN-0394-1F075M	TP075K...	TMS-250	8T-8
	15.88	11.58	25.00	25.40	88.90	1	THN-0625-1F100M	TP100K...	TMS-40	8T-9

E: 28

E: 30-34

Key on E: 1

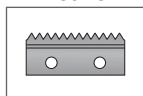

i = Imperial (in)
m = Metric (mm)

AccuThread™ 856 Thread Mill Inserts

Pin Style | NPT / NPTF / BSPT

A
DRILLING

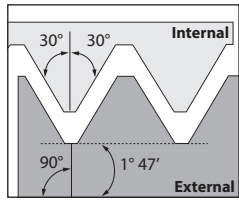

NPT
Internal / External

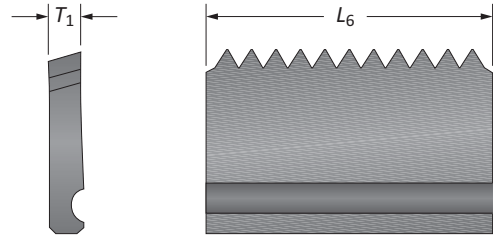

B
BORING

TPI (Pitch)	Insert				Part No.
	L ₆ inch	L ₆ mm	T ₁ inch	T ₁ mm	NPT Internal/External
11.5	1.500	38.10	0.140	3.56	TN150K-NPT11.5
8	1.500	38.10	0.140	3.56	TN150K-NPT8

C
REAMING

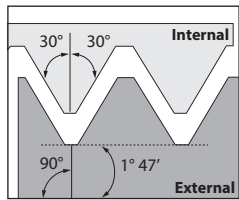

NPTF
Internal / External

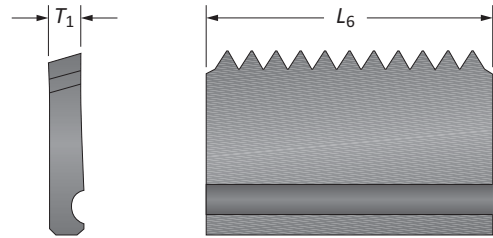

TPI (Pitch)	Insert				Part No.
	L ₆ inch	L ₆ mm	T ₁ inch	T ₁ mm	NPTF Internal/External
11.5	1.500	38.10	0.140	3.56	TN150K-NPTF11.5
8	1.500	38.10	0.140	3.56	TN150K-NPTF8

D
BURNISHING

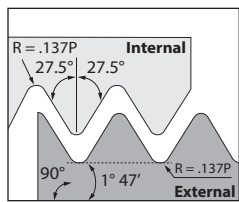

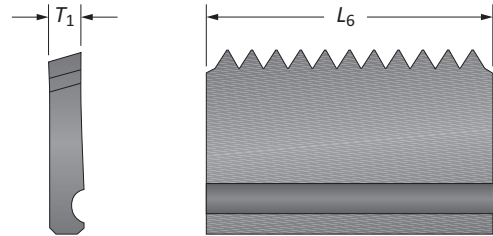

BSPT
Internal / External



TPI (Pitch)	Insert				Part No.
	L ₆ inch	L ₆ mm	T ₁ inch	T ₁ mm	BSPT Internal/External
11	1.500	38.10	0.140	3.56	TN150K-BSPT11

E
THREADING

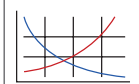
X
SPECIALS

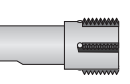
E: 50 - 53  E: 28  E: 42 - 43 

Key on E: 1

Inserts sold in quantities of 2



AccuThread™ 856 Thread Mill Inserts

Pin Style | BSPP / API-ROUND / ACME

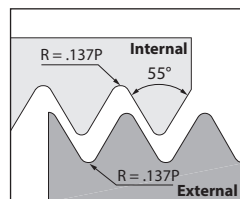

BSPP
Internal / External

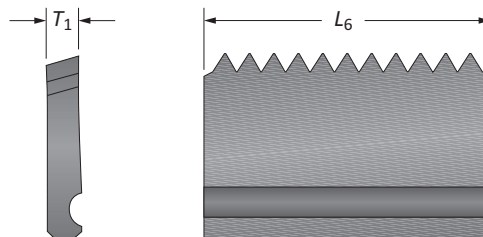

TPI (Pitch)	Insert				Part No.
	L ₆ inch	L ₆ mm	T ₁ inch	T ₁ mm	BSPP Internal/External
11	1.500	38.10	0.140	3.56	TN150K-BSPP11

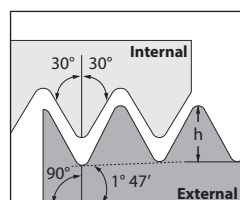

API-ROUND
Internal / External

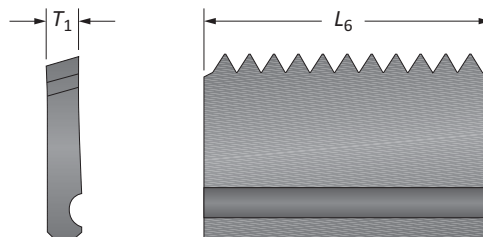

TPI (Pitch)	Insert				Part No.
	L ₆ inch	L ₆ mm	T ₁ inch	T ₁ mm	API-ROUND Internal/External
10	1.500	38.10	0.140	3.56	TN150K-AP10
8	1.500	38.10	0.140	3.56	TN150K-AP8

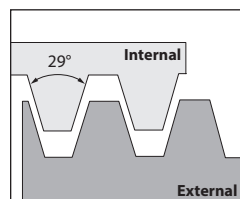

ACME
Full Profile

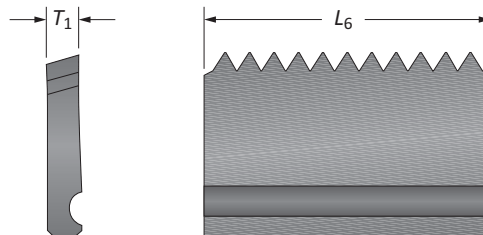

TPI (Pitch)	Insert				Part No.
	L ₆ inch	L ₆ mm	T ₁ inch	T ₁ mm	ACME Full Profile
12	1.000	25.40	0.140	3.56	TN100K-FA12
12	1.500	38.10	0.140	3.56	TN150K-FA12
10	1.000	25.40	0.140	3.56	TN100K-FA10
10	1.500	38.10	0.140	3.56	TN150K-FA10
8	1.000	25.40	0.140	3.56	TN100K-FA8
8	1.500	38.10	0.140	3.56	TN150K-FA8
6	1.500	38.10	0.140	3.56	TN150K-FA6
5	1.500	38.10	0.140	3.56	TN150K-FA5

E: 50 - 53 E: 28 E: 42 - 43

Inserts sold in quantities of 2

AccuThread™ 856 Thread Mill Inserts

Pin Style | UN

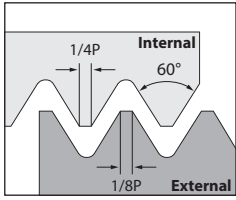

UN
Internal

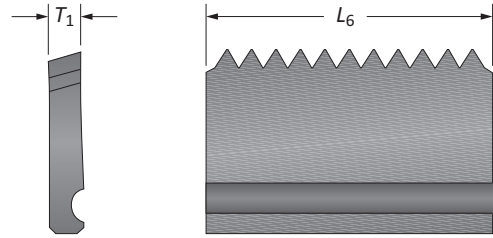



TPI (Pitch)	Insert				Part No. UN Internal
	L ₆ inch	L ₆ mm	T ₁ inch	T ₁ mm	
32	1.000	25.40	0.140	3.56	TN100K-UN32I
24	1.000	25.40	0.140	3.56	TN100K-UN24I
24	1.500	38.10	0.140	3.56	TN150K-UN24I
20	1.000	25.40	0.140	3.56	TN100K-UN20I
20	1.500	38.10	0.140	3.56	TN150K-UN20I
18	1.000	25.40	0.140	3.56	TN100K-UN18I
18	1.500	38.10	0.140	3.56	TN150K-UN18I
16	1.000	25.40	0.140	3.56	TN100K-UN16I
16	1.500	38.10	0.140	3.56	TN150K-UN16I
14	1.500	38.10	0.140	3.56	TN150K-UN14I
12	1.000	25.40	0.140	3.56	TN100K-UN12I
12	1.500	38.10	0.140	3.56	TN150K-UN12I
10	1.000	25.40	0.140	3.56	TN100K-UN10I
10	1.500	38.10	0.140	3.56	TN150K-UN10I
8	1.000	25.40	0.140	3.56	TN100K-UN8I
8	1.500	38.10	0.140	3.56	TN150K-UN8I
7	1.000	25.40	0.140	3.56	TN100K-UN7I
7	1.500	38.10	0.140	3.56	TN150K-UN7I
6	1.500	38.10	0.140	3.56	TN150K-UN6I

D
BURNISHING

F
THREADING

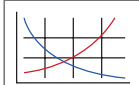
X
SPECIALS

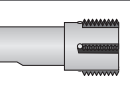
E: 50 - 53  E: 28  E: 42 - 43 

Key on E: 1

Inserts sold in quantities of 2



AccuThread™ 856 Thread Mill Inserts

Pin Style | UN

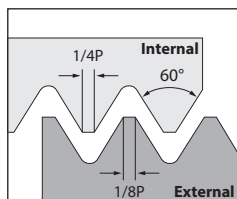

UN
External

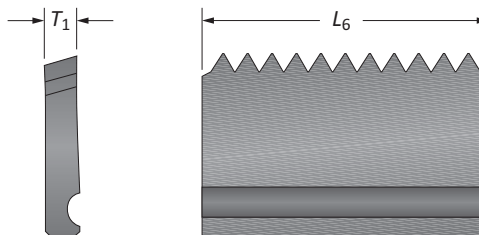

TPI (Pitch)	Insert				Part No.
	L ₆ inch	L ₆ mm	T ₁ inch	T ₁ mm	UN External
32	1.000	25.40	0.140	3.56	TN100K-UN32E
24	1.000	25.40	0.140	3.56	TN100K-UN24E
24	1.500	38.10	0.140	3.56	TN150K-UN24E
20	1.000	25.40	0.140	3.56	TN100K-UN20E
20	1.500	38.10	0.140	3.56	TN150K-UN20E
18	1.000	25.40	0.140	3.56	TN100K-UN18E
18	1.500	38.10	0.140	3.56	TN150K-UN18E
16	1.000	25.40	0.140	3.56	TN100K-UN16E
16	1.500	38.10	0.140	3.56	TN150K-UN16E
12	1.000	25.40	0.140	3.56	TN100K-UN12E
12	1.500	38.10	0.140	3.56	TN150K-UN12E
10	1.000	25.40	0.140	3.56	TN100K-UN10E
10	1.500	38.10	0.140	3.56	TN150K-UN10E
8	1.000	25.40	0.140	3.56	TN100K-UN8E
8	1.500	38.10	0.140	3.56	TN150K-UN8E
6	1.500	38.10	0.140	3.56	TN150K-UN6E

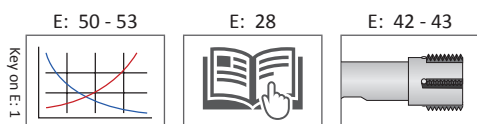

Inserts sold in quantities of 2

AccuThread™ 856 Thread Mill Inserts

Pin Style | UNJ

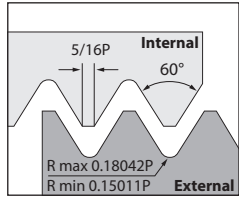

UNJ
Internal

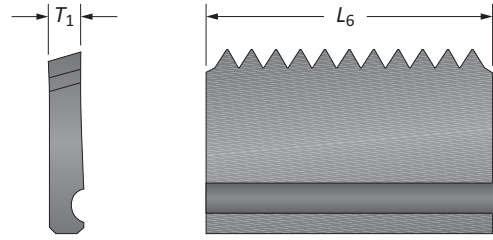

TPI (Pitch)	Insert				Part No. UNJ Internal
	L ₆ inch	L ₆ mm	T ₁ inch	T ₁ mm	
32	1.000	25.40	0.140	3.56	TN100K-UNJ32I
24	1.000	25.40	0.140	3.56	TN100K-UNJ24I
24	1.500	38.10	0.140	3.56	TN150K-UNJ24I
20	1.000	25.40	0.140	3.56	TN100K-UNJ20I
20	1.500	38.10	0.140	3.56	TN150K-UNJ20I
18	1.000	25.40	0.140	3.56	TN100K-UNJ18I
18	1.500	38.10	0.140	3.56	TN150K-UNJ18I
16	1.000	25.40	0.140	3.56	TN100K-UNJ16I
16	1.500	38.10	0.140	3.56	TN150K-UNJ16I
12	1.000	25.40	0.140	3.56	TN100K-UNJ12I
12	1.500	38.10	0.140	3.56	TN150K-UNJ12I
8	1.500	38.10	0.140	3.56	TN150K-UNJ8I

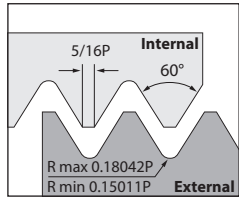

UNJ
External

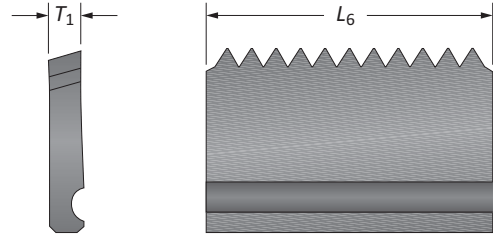

TPI (Pitch)	Insert				Part No. UNJ External
	L ₆ inch	L ₆ mm	T ₁ inch	T ₁ mm	
32	1.000	25.40	0.140	3.56	TN100K-UNJ32E
24	1.000	25.40	0.140	3.56	TN100K-UNJ24E
24	1.500	38.10	0.140	3.56	TN150K-UNJ24E
20	1.000	25.40	0.140	3.56	TN100K-UNJ20E
20	1.500	38.10	0.140	3.56	TN150K-UNJ20E
18	1.000	25.40	0.140	3.56	TN100K-UNJ18E
18	1.500	38.10	0.140	3.56	TN150K-UNJ18E
16	1.000	25.40	0.140	3.56	TN100K-UNJ16E
16	1.500	38.10	0.140	3.56	TN150K-UNJ16E
12	1.000	25.40	0.140	3.56	TN100K-UNJ12E
12	1.500	38.10	0.140	3.56	TN150K-UNJ12E
8	1.500	38.10	0.140	3.56	TN150K-UNJ8E

E: 50 - 53 E: 28 E: 42 - 43

Inserts sold in quantities of 2



AccuThread™ 856 Thread Mill Inserts

Pin Style | ISO

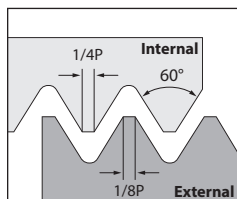

ISO
Internal

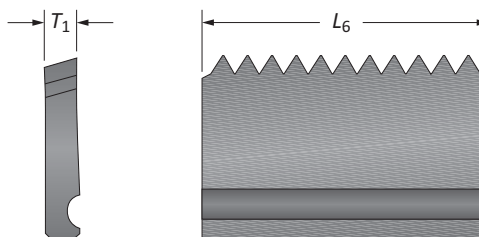

Pitch	Insert				Part No.
	L ₆ inch	L ₆ mm	T ₁ inch	T ₁ mm	ISO Internal
1.5	1.500	38.10	0.140	3.56	TN150K-M1.5I
2.0	1.500	38.10	0.140	3.56	TN150K-M2.0I
2.5	1.500	38.10	0.140	3.56	TN150K-M2.5I
3.0	1.500	38.10	0.140	3.56	TN150K-M3.0I
3.5	1.500	38.10	0.140	3.56	TN150K-M3.5I
4.0	1.500	38.10	0.140	3.56	TN150K-M4.0I
4.5	1.500	38.10	0.140	3.56	TN150K-M4.5I
5.0	1.500	38.10	0.140	3.56	TN150K-M5.0I
6.0	1.500	38.10	0.140	3.56	TN150K-M6.0I

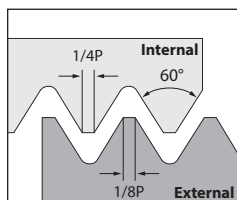

ISO
External

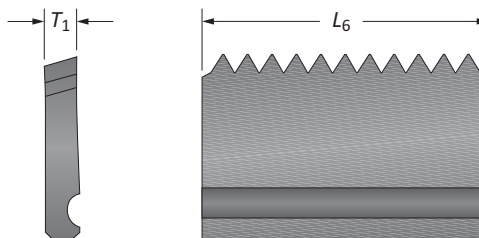

Pitch	Insert				Part No.
	L ₆ inch	L ₆ mm	T ₁ inch	T ₁ mm	ISO External
2.0	1.500	38.10	0.140	3.56	TN150K-M2.0E
4.0	1.500	38.10	0.140	3.56	TN150K-M4.0E
4.5	1.500	38.10	0.140	3.56	TN150K-M4.5E
5.0	1.500	38.10	0.140	3.56	TN150K-M5.0E
6.0	1.500	38.10	0.140	3.56	TN150K-M6.0E

A

DRILLING

B

BORING

C

REAMING

D

BURNISHING

E

THREADING

X

SPECIALS

E: 50 - 53 Key on E: 1

E: 28

E: 42 - 43

Inserts sold in quantities of 2

AccuThread™ Pin Style Holders

Weldon Shank

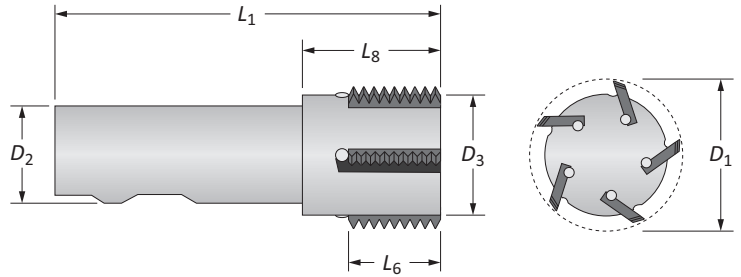
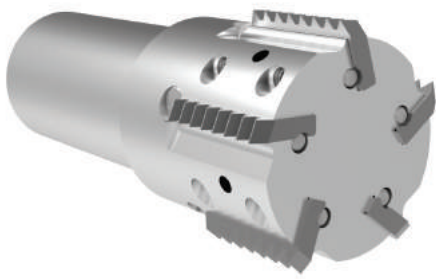

Positive Rake

	D_1		Holder					Coolant	Flutes	Part No.	Inserts	Screw	Key Size	Pin
	Standard	Oversize*	D_3	L_8	L_6	L_1	D_2							
i	0.969	–	0.750	1.38	1.000	4.500	1.000	N	2	THP-0969-2F100	TN100K...	TMSS-3	3/32	TMP-1
	1.755	–	1.500	2.25	1.000	4.000	1.250	Y	5	THP-1755-5F100	TN100K...	TMSS-2	3/32	TMP-1
	0.932	1.063	0.722	1.90	1.500	4.500	1.000	N	1	THP-0932-1F150	TN150K...	TMSS-2	3/32	TMP-2
	0.969	1.100	0.750	2.00	1.500	4.500	1.000	N	2	THP-0969-2F150	TN150K...	TMSS-3	3/32	TMP-2
	1.116	1.247	0.812	2.00	1.500	4.500	1.000	Y	3	THP-1116-3F150	TN150K...	TMSS-3	3/32	TMP-2
	1.755	1.887	1.500	2.25	1.500	4.500	1.250	Y	5	THP-1755-5F150	TN150K...	TMSS-2	3/32	TMP-2
m	24.61	–	19.05	35.05	25.40	114.30	25.00	N	2	THP-0969-2F100M	TN100K...	TMSS-3	3/32	TMP-1
	44.58	–	38.10	57.15	25.40	101.60	32.00	Y	5	THP-1755-5F100M	TN100K...	TMSS-2	3/32	TMP-1
	23.67	27.00	18.34	48.44	38.10	114.30	25.00	N	1	THP-0932-1F150M	TN150K...	TMSS-2	3/32	TMP-2
	24.61	27.94	19.05	50.80	38.10	114.30	25.00	N	2	THP-0969-2F150M	TN150K...	TMSS-3	3/32	TMP-2
	28.35	31.67	20.63	50.80	38.10	114.30	25.00	Y	3	THP-1116-3F150M	TN150K...	TMSS-3	3/32	TMP-2
	44.58	47.93	38.10	57.15	38.10	114.30	32.00	Y	5	THP-1755-5F150M	TN150K...	TMSS-2	3/32	TMP-2

*See note at bottom of page

Neutral Rake

	D_1		Holder					Coolant	Flutes	Part No.	Inserts	Screw	Key Size	Pin
	Standard	Oversize*	D_3	L_8	L_6	L_1	D_2							
i	1.116	1.247	0.812	2.00	1.500	4.500	1.000	Y	3	TNR-1116-3F150	TN150K...	TMSS-3	3/32	TMP-2
	1.755	1.887	1.500	2.25	1.500	4.531	1.250	Y	5	TNR-1755-5F150	TN150K...	TMSS-2	3/32	TMP-2
m	28.35	31.67	20.63	50.80	38.10	114.30	25.00	Y	3	TNR-1116-3F150M	TN150K...	TMSS-3	3/32	TMP-2
	44.58	47.93	38.10	57.15	38.10	114.30	32.00	Y	5	TNR-1755-5F150M	TN150K...	TMSS-2	3/32	TMP-2

*See note at bottom of page

*Oversized cutter diameter occurs when assembled with the following pin style inserts:

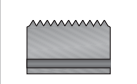
Key on E: 1	E: 28	E: 36 - 41	NPT 8	API 8	Metric 6.0	ACME 5
			NPTF 11.5		Metric 5.0	ACME 6
			NPTF 8		Metric 4.5	

i = Imperial (in)
m = Metric (mm)



AccuThread™ Pin Style Holders

Shell Mill

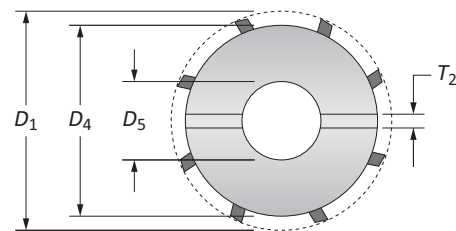
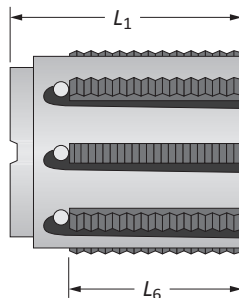

Positive Rake

	D ₁		Holder					Flutes	Part No.	Inserts	Screw	Key Size	Pin
	Standard	Oversize*	D ₄	D ₅	L ₆	L ₁	T ₂						
i	2.714	2.845	2.500	1.000	1.500	2.250	0.375	7	TSN-2846-7F150	TN150K...	TMSS-2	3/32	TMP-2
	3.208	3.340	3.000	1.250	1.500	2.250	0.500	8	TSN-3341-8F150	TN150K...	TMSS-2	3/32	TMP-2
m	68.94	72.26	63.50	27.00	38.10	57.15	12	7	TSN-2846-7F150M	TN150K...	TMSS-2	3/32	TMP-2
	81.48	84.84	76.20	32.00	38.10	57.15	14	8	TSN-3341-8F150M	TN150K...	TMSS-2	3/32	TMP-2

*See note at bottom of page

Neutral Rake

	D ₁		Holder					Flutes	Part No.	Inserts	Screw	Key Size	Pin
	Standard	Oversize*	D ₄	D ₅	L ₆	L ₁	T ₂						
i	2.217	2.349	2.000	0.750	1.500	2.250	0.312	6	TSR-2217-6F150	TN150K...	TMSS-2	3/32	TMP-2
m	56.31	59.66	50.80	22.00	38.10	57.15	10.00	6	TSR-2217-6F150M	TN150K...	TMSS-2	3/32	TMP-2

*See note at bottom of page

E: 28

E: 36 - 41

*Oversized cutter diameter occurs when assembled with the following pin style inserts:

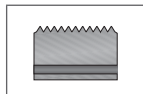

NPT 8
NPTF 11.5
NPTF 8

API 8

Metric 6.0
Metric 5.0
Metric 4.5

ACME 5
ACME 6

i = Imperial (in)
m = Metric (mm)

Thread Mill Pre-Drill Information

Linear Feed Rate (LFR)

$$LFR = RPM \cdot (IPT \cdot \text{Number of flutes})$$

RPM = Revolutions per minute

IPT = Recommended feed (inch / tooth)

Surface Feet per Minute (SFM)

$$SFM = RPM \cdot 0.262 \cdot \text{Diameter}$$

RPM = Revolutions per minute

Revolutions per Minute (RPM)

$$RPM = \frac{SFM \cdot 3.82}{\text{Diameter}}$$

SFM = Surface feet per minute

Adjusted Feed Rate (AFR) - For Internal Threading

$$AFR = \frac{\text{Major Diameter} - \text{Cutter Diameter}}{\text{Major Diameter}} [LFR]$$

LFR = Linear feed rate

NOTICE: The above formula on an internal thread program adjusts the linear feed rate to be applied to the outer diameter instead of the center of the cutting tool. If the feed rate is not adjusted, the excessive feed rate will cause the thread mill cutting edges to fail.

Example of an Internal Adjusted Feed Rate Calculation:

Cast iron 125 BHN with a 1/2-13 thread form using AccuThread 856 solid carbide (TMUK0500-13)

STEP 1:

$$RPM = \frac{SFM \cdot 3.82}{\text{Diameter}}$$

$$RPM = \frac{675 \cdot 3.82}{0.350}$$

$$RPM = 7367$$

STEP 2:

$$LFR = RPM \cdot (IPT \cdot \text{Number of flutes})$$

$$LFR = 7367 \cdot (0.0010 \cdot 4)$$

$$LFR = 29.47 \text{ IPM}$$

STEP 3:

$$AFR = \frac{\text{Major Diameter} - \text{Cutter Diameter}}{\text{Major Diameter}} [LFR]$$

$$AFR = \frac{0.500 - 0.350}{0.500} [29.47]$$

$$AFR = 8.84 \text{ IPM}$$

Thread Mill Calculations and Recommended Passes

Thread Mill Drill Calculation

Based on nominal tap drill diameter. Based on 0.003" or 0.075mm probable mean oversize.

To calculate the percent of full thread for a given hole diameter:

IMPERIAL: % of thread = # of threads per inch • $\frac{\text{Basic major diameter of thread} - \text{Drill hole size}}{0.0130}$

METRIC: % of thread = $\frac{76.96}{\text{Pitch (mm)}}$ • [Basic major diameter of thread - Drill hole size]

Major Thread Diameter for # Drills

Drill #	Thread Diameter
# 2	0.086
# 3	0.099
# 4	0.112
# 5	0.125
# 6	0.132
# 8	0.164
# 10	0.190
# 12	0.216

Recommended Passes

Pitch Size	Machinability		
	Easy	Average	Difficult
28	1	1	2
27	1	1	2
19	1	1	2
18	1	1	2
14	1	2	3
11.5	1	2	3
11	1	2	3
10	1	2	3
8	2	3	4

- 1 Pass
- 2 Passes
- 3 Passes
- 4 Passes

Pitch Size	Machinability		
	Easy	Average	Difficult
0.40	1	1	2
0.45	1	1	2
0.50	1	1	2
0.70	1	1	2
0.75	1	1	2
0.80	1	1	2
1.00	1	1	2
1.25	1	2	3
1.50	1	2	3
1.75	1	2	3
2.00	1	2	3
2.50	2	3	4
3.00	2	3	4
3.50	2	3	4
4.00	2	3	4
4.50	2	3	4
5.00	2	3	4
6.00	2	3	4

Pitch Size	Machinability		
	Easy	Average	Difficult
64	1	1	2
56	1	1	2
48	1	1	2
44	1	1	2
40	1	1	2
36	1	1	2
32	1	1	2
28	1	1	2
24	1	1	2
20	1	2	3
19	1	2	3
18	1	2	3
16	1	2	3
14	1	2	3
13	1	2	3
12	1	2	3
11	2	2	4
10	2	3	4
9	2	3	4
8	2	3	4
7	2	3	4
6	2	3	4

Recommended Cutting Data | Imperial (inch)

Solid Carbide | AccuThread™ 856

ISO	Material	Hardness (BHN)	Machinability*	Speed (SFM)	Recommended Feed (inch/tooth) by Cutter Diameter							
					0.060 to 0.125	0.126 to 0.188	0.189 to 0.250	0.251 to 0.312	0.313 to 0.375	0.376 to 0.500	0.501 to 0.625	0.626 to 0.750
P	Free Machining Steel 1118, 1215, 12L14, etc.	100 - 150	Easy	900	0.0004	0.0005	0.0007	0.0009	0.0010	0.0015	0.0020	0.0025
		150 - 200	Easy	700	0.0004	0.0005	0.0007	0.0009	0.0010	0.0015	0.0020	0.0025
		200 - 250	Easy	500	0.0004	0.0005	0.0007	0.0009	0.0010	0.0015	0.0020	0.0025
	Low Carbon Steel 1010, 1020, 1025, 1522, 1144	85 - 125	Average	900	0.0004	0.0005	0.0007	0.0009	0.0010	0.0015	0.0020	0.0025
		125 - 175	Average	700	0.0004	0.0005	0.0007	0.0009	0.0010	0.0015	0.0020	0.0025
		175 - 225	Average	600	0.0004	0.0005	0.0007	0.0009	0.0010	0.0015	0.0020	0.0025
		225 - 275	Average	500	0.0004	0.0005	0.0007	0.0009	0.0010	0.0015	0.0020	0.0025
	Medium Carbon Steel 1010, 1040, 1050, 1527, 1140	125 - 175	Average	575	0.0004	0.0005	0.0006	0.0008	0.0010	0.0013	0.0018	0.0020
		175 - 225	Average	500	0.0004	0.0005	0.0006	0.0008	0.0010	0.0013	0.0018	0.0020
		225 - 275	Average	450	0.0004	0.0005	0.0006	0.0008	0.0010	0.0013	0.0018	0.0020
		275 - 325	Average	400	0.0004	0.0005	0.0006	0.0008	0.0010	0.0013	0.0018	0.0020
	Alloy Steel 4140, 5140, 8640	125 - 175	Average	575	0.0004	0.0005	0.0006	0.0008	0.0010	0.0013	0.0018	0.0020
		175 - 225	Average	500	0.0004	0.0005	0.0006	0.0008	0.0010	0.0013	0.0018	0.0020
		225 - 275	Average	450	0.0004	0.0005	0.0006	0.0008	0.0010	0.0013	0.0018	0.0020
		275 - 325	Difficult	400	0.0004	0.0005	0.0006	0.0008	0.0010	0.0013	0.0018	0.0020
		325 - 375	Difficult	375	0.0004	0.0005	0.0006	0.0008	0.0010	0.0013	0.0018	0.0020
	High Strength Alloy 4340, 4330V, 300M	225 - 300	Average	450	0.0004	0.0005	0.0006	0.0008	0.0010	0.0013	0.0018	0.0020
		300 - 350	Difficult	400	0.0004	0.0005	0.0006	0.0008	0.0010	0.0013	0.0018	0.0020
350 - 400		Difficult	350	0.0004	0.0005	0.0006	0.0008	0.0010	0.0013	0.0018	0.0020	
Structural Steel A36, A285, A516	100 - 150	Average	600	0.0004	0.0005	0.0007	0.0009	0.0010	0.0015	0.0020	0.0025	
	150 - 250	Average	500	0.0004	0.0005	0.0007	0.0009	0.0010	0.0015	0.0020	0.0025	
	250 - 350	Difficult	450	0.0004	0.0005	0.0007	0.0009	0.0010	0.0015	0.0020	0.0025	
S	High Temp Alloy Hastelloy B, Inconel 600	140 - 220	Difficult	120	0.0003	0.0004	0.0006	0.0008	0.0009	0.0010	0.0012	0.0015
		220 - 310	Difficult	90	0.0003	0.0004	0.0006	0.0008	0.0009	0.0010	0.0012	0.0015
M	Stainless Steel 303, 416, 420	135 - 185	Difficult	525	0.0004	0.0005	0.0006	0.0008	0.0009	0.0010	0.0015	0.0020
		185 - 275	Difficult	500	0.0004	0.0005	0.0006	0.0008	0.0009	0.0010	0.0015	0.0020
	Stainless Steel PH 17-4	185 - 275	Difficult	300	0.0004	0.0005	0.0006	0.0008	0.0009	0.0010	0.0015	0.0020
		275 - 325	Difficult	150	0.0004	0.0005	0.0006	0.0008	0.0009	0.0010	0.0015	0.0020
	Tool Steel H-13, H21, A-4	150 - 200	Difficult	575	0.0004	0.0005	0.0007	0.0009	0.0010	0.0015	0.0020	0.0025
200 - 250		Difficult	500	0.0004	0.0005	0.0007	0.0009	0.0010	0.0015	0.0020	0.0025	
K	Cast Iron Grey, Ductile, Nodular	120 - 150	Easy	675	0.0004	0.0005	0.0007	0.0009	0.0010	0.0015	0.0020	0.0025
		150 - 200	Easy	625	0.0004	0.0005	0.0007	0.0009	0.0010	0.0015	0.0020	0.0025
		200 - 220	Easy	575	0.0004	0.0005	0.0007	0.0009	0.0010	0.0015	0.0020	0.0025
		220 - 260	Average	500	0.0004	0.0005	0.0007	0.0009	0.0010	0.0015	0.0020	0.0025
		260 - 320	Average	475	0.0004	0.0005	0.0007	0.0009	0.0010	0.0015	0.0020	0.0025
N	Wrought Aluminum 6061 T6	30	Easy	1100	0.0005	0.0006	0.0009	0.0010	0.0015	0.0020	0.0025	0.0030
		180	Easy	1000	0.0005	0.0006	0.0009	0.0010	0.0015	0.0020	0.0025	0.0030
	Cast Aluminum** up to 10% silicon	120	Easy	625	0.0005	0.0006	0.0009	0.0010	0.0015	0.0020	0.0025	0.0030
	Brass	30 - 125	Easy	1100	0.0005	0.0006	0.0009	0.0010	0.0015	0.0020	0.0025	0.0030

NOTICE: Reduce feed and speed by 30% for tapered thread forms due to additional material removal

*Refer to recommended pass chart on page E: 45 when referencing material machinability

**Uncoated thread mills are recommended for cast aluminum applications

Recommended Cutting Data | Metric (mm)

Solid Carbide | AccuThread™ 856

ISO	Material	Hardness (BHN)	Machinability*	Speed (M/min)	Recommended Feed (mm/tooth) by Cutter Diameter							
					1.50 to 3.18	3.19 to 4.76	4.77 to 6.35	6.36 to 7.94	7.95 to 9.53	9.54 to 12.70	12.71 to 15.88	15.89 to 19.05
P	Free Machining Steel 1118, 1215, 12L14, etc.	100 - 150	Easy	274	0.010	0.013	0.018	0.023	0.025	0.038	0.051	0.064
		150 - 200	Easy	213	0.010	0.013	0.018	0.023	0.025	0.038	0.051	0.064
		200 - 250	Easy	152	0.010	0.013	0.018	0.023	0.025	0.038	0.051	0.064
	Low Carbon Steel 1010, 1020, 1025, 1522, 1144	85 - 125	Average	274	0.010	0.013	0.018	0.023	0.025	0.038	0.051	0.064
		125 - 175	Average	213	0.010	0.013	0.018	0.023	0.025	0.038	0.051	0.064
		175 - 225	Average	183	0.010	0.013	0.018	0.023	0.025	0.038	0.051	0.064
	Medium Carbon Steel 1010, 1040, 1050, 1527, 1140	225 - 275	Average	152	0.010	0.013	0.018	0.023	0.025	0.038	0.051	0.064
		125 - 175	Average	175	0.010	0.013	0.015	0.020	0.025	0.033	0.046	0.051
		175 - 225	Average	152	0.010	0.013	0.015	0.020	0.025	0.033	0.046	0.051
		225 - 275	Average	137	0.010	0.013	0.015	0.020	0.025	0.033	0.046	0.051
	Alloy Steel 4140, 5140, 8640	275 - 325	Average	122	0.010	0.013	0.015	0.020	0.025	0.033	0.046	0.051
		125 - 175	Average	175	0.010	0.013	0.015	0.020	0.025	0.033	0.046	0.051
		175 - 225	Average	152	0.010	0.013	0.015	0.020	0.025	0.033	0.046	0.051
		225 - 275	Average	137	0.010	0.013	0.015	0.020	0.025	0.033	0.046	0.051
	High Strength Alloy 4340, 4330V, 300M	275 - 325	Difficult	122	0.010	0.013	0.015	0.020	0.025	0.033	0.046	0.051
		325 - 375	Difficult	114	0.010	0.013	0.015	0.020	0.025	0.033	0.046	0.051
		225 - 300	Average	137	0.010	0.013	0.015	0.020	0.025	0.033	0.046	0.051
	Structural Steel A36, A285, A516	300 - 350	Difficult	122	0.010	0.013	0.015	0.020	0.025	0.033	0.046	0.051
350 - 400		Difficult	107	0.010	0.013	0.015	0.020	0.025	0.033	0.046	0.051	
S	High Temp Alloy Hastelloy B, Inconel 600	100 - 150	Average	183	0.010	0.013	0.018	0.023	0.025	0.038	0.051	0.064
		150 - 250	Average	152	0.010	0.013	0.018	0.023	0.025	0.038	0.051	0.064
		250 - 350	Difficult	137	0.010	0.013	0.018	0.023	0.025	0.038	0.051	0.064
		140 - 220	Difficult	37	0.008	0.010	0.015	0.020	0.023	0.025	0.030	0.038
		220 - 310	Difficult	27	0.008	0.010	0.015	0.020	0.023	0.025	0.030	0.038
		M	Stainless Steel 303, 416, 420	135 - 185	Difficult	160	0.010	0.013	0.015	0.020	0.023	0.025
185 - 275	Difficult			152	0.010	0.013	0.015	0.020	0.023	0.025	0.038	0.051
Stainless Steel PH 17-4	185 - 275		Difficult	91	0.010	0.013	0.015	0.020	0.023	0.025	0.038	0.051
	275 - 325		Difficult	46	0.010	0.013	0.015	0.020	0.023	0.025	0.038	0.051
Tool Steel H-13, H21, A-4	150 - 200	Difficult	175	0.010	0.013	0.018	0.023	0.025	0.038	0.051	0.064	
	200 - 250	Difficult	152	0.010	0.013	0.018	0.023	0.025	0.038	0.051	0.064	
K	Cast Iron Grey, Ductile, Nodular	120 - 150	Easy	206	0.010	0.013	0.018	0.023	0.025	0.038	0.051	0.064
		150 - 200	Easy	191	0.010	0.013	0.018	0.023	0.025	0.038	0.051	0.064
		200 - 220	Easy	175	0.010	0.013	0.018	0.023	0.025	0.038	0.051	0.064
		220 - 260	Average	152	0.010	0.013	0.018	0.023	0.025	0.038	0.051	0.064
		260 - 320	Average	145	0.010	0.013	0.018	0.023	0.025	0.038	0.051	0.064
N	Wrought Aluminum 6061 T6	30	Easy	335	0.013	0.015	0.023	0.025	0.038	0.051	0.064	0.076
		180	Easy	305	0.013	0.015	0.023	0.025	0.038	0.051	0.064	0.076
	Cast Aluminum** up to 10% silicon	120	Easy	191	0.013	0.015	0.023	0.025	0.038	0.051	0.064	0.076
	Brass	30 - 125	Easy	335	0.013	0.015	0.023	0.025	0.038	0.051	0.064	0.076

NOTICE: Reduce feed and speed by 30% for tapered thread forms due to additional material removal

*Refer to recommended pass chart on page E: 45 when referencing material machinability

**Uncoated thread mills are recommended for cast aluminum applications

A
DRILLING
B
BORING
C
REAMING
D
BURNISHING
E
THREADING
X
SPECIALS

Recommended Cutting Data | Imperial (inch)

Solid Carbide | ThreadMills USA

ISO	Material	Hardness (BHN)	Machinability*	Speed (SFM)	Recommended Feed (inch/tooth) by Cutter Diameter							
					0.060 to 0.125	0.126 to 0.188	0.189 to 0.250	0.251 to 0.312	0.313 to 0.375	0.376 to 0.500	0.501 to 0.625	0.626 to 0.750
P	Free Machining Steel 1118, 1215, 12L14, etc.	100 - 150	Easy	725	0.0004	0.0005	0.0007	0.0009	0.0010	0.0015	0.0020	0.0025
		150 - 200	Easy	550	0.0004	0.0005	0.0007	0.0009	0.0010	0.0015	0.0020	0.0025
		200 - 250	Easy	450	0.0004	0.0005	0.0007	0.0009	0.0010	0.0015	0.0020	0.0025
	Low Carbon Steel 1010, 1020, 1025, 1522, 1144	85 - 125	Average	725	0.0004	0.0005	0.0007	0.0009	0.0010	0.0015	0.0020	0.0025
		125 - 175	Average	550	0.0004	0.0005	0.0007	0.0009	0.0010	0.0015	0.0020	0.0025
		175 - 225	Average	450	0.0004	0.0005	0.0007	0.0009	0.0010	0.0015	0.0020	0.0025
		225 - 275	Average	400	0.0004	0.0005	0.0007	0.0009	0.0010	0.0015	0.0020	0.0025
	Medium Carbon Steel 1010, 1040, 1050, 1527, 1140	125 - 175	Average	450	0.0004	0.0005	0.0006	0.0008	0.0010	0.0013	0.0018	0.0020
		175 - 225	Average	400	0.0004	0.0005	0.0006	0.0008	0.0010	0.0013	0.0018	0.0020
		225 - 275	Average	350	0.0004	0.0005	0.0006	0.0008	0.0010	0.0013	0.0018	0.0020
		275 - 325	Average	300	0.0004	0.0005	0.0006	0.0008	0.0010	0.0013	0.0018	0.0020
	Alloy Steel 4140, 5140, 8640	125 - 175	Average	450	0.0004	0.0005	0.0006	0.0008	0.0010	0.0013	0.0018	0.0020
		175 - 225	Average	400	0.0004	0.0005	0.0006	0.0008	0.0010	0.0013	0.0018	0.0020
		225 - 275	Average	350	0.0004	0.0005	0.0006	0.0008	0.0010	0.0013	0.0018	0.0020
		275 - 325	Difficult	300	0.0004	0.0005	0.0006	0.0008	0.0010	0.0013	0.0018	0.0020
		325 - 375	Difficult	250	0.0004	0.0005	0.0006	0.0008	0.0010	0.0013	0.0018	0.0020
	High Strength Alloy 4340, 4330V, 300M	225 - 300	Average	350	0.0004	0.0005	0.0006	0.0008	0.0010	0.0013	0.0018	0.0020
		300 - 350	Difficult	300	0.0004	0.0005	0.0006	0.0008	0.0010	0.0013	0.0018	0.0020
350 - 400		Difficult	250	0.0004	0.0005	0.0006	0.0008	0.0010	0.0013	0.0018	0.0020	
Structural Steel A36, A285, A516	100 - 150	Average	450	0.0004	0.0005	0.0007	0.0009	0.0010	0.0015	0.0020	0.0025	
	150 - 250	Average	400	0.0004	0.0005	0.0007	0.0009	0.0010	0.0015	0.0020	0.0025	
	250 - 350	Difficult	300	0.0004	0.0005	0.0007	0.0009	0.0010	0.0015	0.0020	0.0025	
S	High Temp Alloy Hastelloy B, Inconel 600	140 - 220	Difficult	100	0.0003	0.0004	0.0006	0.0008	0.0009	0.0010	0.0012	0.0015
		220 - 310	Difficult	75	0.0003	0.0004	0.0006	0.0008	0.0009	0.0010	0.0012	0.0015
M	Stainless Steel 303, 416, 420	135 - 185	Difficult	425	0.0004	0.0005	0.0006	0.0008	0.0009	0.0010	0.0015	0.0020
		185 - 275	Difficult	400	0.0004	0.0005	0.0006	0.0008	0.0009	0.0010	0.0015	0.0020
	Stainless Steel PH 17-4	185 - 275	Difficult	250	0.0004	0.0005	0.0006	0.0008	0.0009	0.0010	0.0015	0.0020
		275 - 325	Difficult	125	0.0004	0.0005	0.0006	0.0008	0.0009	0.0010	0.0015	0.0020
	Tool Steel H-13, H21, A-4	150 - 200	Difficult	325	0.0004	0.0005	0.0007	0.0008	0.0010	0.0015	0.0020	0.0025
200 - 250		Difficult	225	0.0004	0.0005	0.0007	0.0008	0.0010	0.0015	0.0020	0.0025	
K	Cast Iron Grey, Ductile, Nodular	120 - 150	Easy	550	0.0004	0.0005	0.0007	0.0009	0.0010	0.0015	0.0020	0.0025
		150 - 200	Easy	500	0.0004	0.0005	0.0007	0.0009	0.0010	0.0015	0.0020	0.0025
		200 - 220	Easy	450	0.0004	0.0005	0.0007	0.0009	0.0010	0.0015	0.0020	0.0025
		220 - 260	Average	400	0.0004	0.0005	0.0007	0.0009	0.0010	0.0015	0.0020	0.0025
		260 - 320	Average	375	0.0004	0.0005	0.0007	0.0009	0.0010	0.0015	0.0020	0.0025
N	Wrought Aluminum 6061 T6	30	Easy	1000	0.0005	0.0006	0.0009	0.0010	0.0015	0.0020	0.0025	0.0030
		180	Easy	900	0.0005	0.0006	0.0009	0.0010	0.0015	0.0020	0.0025	0.0030
	Cast Aluminum** up to 10% silicon	120	Easy	500	0.0005	0.0006	0.0009	0.0010	0.0015	0.0020	0.0025	0.0030
	Brass	30 - 125	Easy	1000	0.0005	0.0006	0.0009	0.0010	0.0015	0.0020	0.0025	0.0030

NOTICE: Reduce feed and speed by 30% for tapered thread forms due to additional material removal

*Refer to recommended pass chart on page E: 45 when referencing material machinability

**Uncoated thread mills are recommended for cast aluminum applications

Recommended Cutting Data | Metric (mm)

Solid Carbide | ThreadMills USA

ISO	Material	Hardness (BHN)	Machinability*	Speed (M/min)	Recommended Feed (mm/tooth) by Cutter Diameter							
					1.50 to 3.18	3.19 to 4.76	4.77 to 6.35	6.36 to 7.94	7.95 to 9.53	9.54 to 12.70	12.71 to 15.88	15.89 to 19.05
P	Free Machining Steel 1118, 1215, 12L14, etc.	100 - 150	Easy	221	0.010	0.013	0.018	0.023	0.025	0.038	0.051	0.064
		150 - 200	Easy	168	0.010	0.013	0.018	0.023	0.025	0.038	0.051	0.064
		200 - 250	Easy	137	0.010	0.013	0.018	0.023	0.025	0.038	0.051	0.064
	Low Carbon Steel 1010, 1020, 1025, 1522, 1144	85 - 125	Average	221	0.010	0.013	0.018	0.023	0.025	0.038	0.051	0.064
		125 - 175	Average	168	0.010	0.013	0.018	0.023	0.025	0.038	0.051	0.064
		175 - 225	Average	137	0.010	0.013	0.018	0.023	0.025	0.038	0.051	0.064
	Medium Carbon Steel 1010, 1040, 1050, 1527, 1140	225 - 275	Average	122	0.010	0.013	0.018	0.023	0.025	0.038	0.051	0.064
		125 - 175	Average	137	0.010	0.013	0.015	0.020	0.025	0.038	0.046	0.051
		175 - 225	Average	122	0.010	0.013	0.015	0.020	0.025	0.038	0.046	0.051
		225 - 275	Average	107	0.010	0.013	0.015	0.020	0.025	0.038	0.046	0.051
	Alloy Steel 4140, 5140, 8640	275 - 325	Average	91	0.010	0.013	0.015	0.020	0.025	0.038	0.046	0.051
		125 - 175	Average	137	0.010	0.013	0.015	0.020	0.025	0.038	0.046	0.051
		175 - 225	Average	122	0.010	0.013	0.015	0.020	0.025	0.038	0.046	0.051
		225 - 275	Average	107	0.010	0.013	0.015	0.020	0.025	0.038	0.046	0.051
		275 - 325	Difficult	91	0.010	0.013	0.015	0.020	0.025	0.038	0.046	0.051
	High Strength Alloy 4340, 4330V, 300M	325 - 375	Difficult	76	0.010	0.013	0.015	0.020	0.025	0.038	0.046	0.051
		225 - 300	Average	107	0.010	0.013	0.015	0.020	0.025	0.038	0.046	0.051
		300 - 350	Difficult	91	0.010	0.013	0.015	0.020	0.025	0.038	0.046	0.051
Structural Steel A36, A285, A516	350 - 400	Difficult	76	0.010	0.013	0.015	0.020	0.025	0.038	0.046	0.051	
	100 - 150	Average	137	0.010	0.013	0.018	0.023	0.025	0.038	0.051	0.064	
	150 - 250	Average	122	0.010	0.013	0.018	0.023	0.025	0.038	0.051	0.064	
S	High Temp Alloy Hastelloy B, Inconel 600	250 - 350	Difficult	91	0.010	0.013	0.018	0.023	0.025	0.038	0.051	0.064
		140 - 220	Difficult	30	0.008	0.010	0.015	0.020	0.023	0.025	0.030	0.038
M	Stainless Steel 303, 416, 420	220 - 310	Difficult	23	0.008	0.010	0.015	0.020	0.023	0.025	0.030	0.038
		135 - 185	Difficult	130	0.010	0.013	0.015	0.020	0.023	0.025	0.038	0.051
	Stainless Steel PH 17-4	185 - 275	Difficult	122	0.010	0.013	0.015	0.020	0.023	0.025	0.038	0.051
		275 - 325	Difficult	76	0.010	0.013	0.015	0.020	0.023	0.025	0.038	0.051
	Tool Steel H-13, H21, A-4	185 - 275	Difficult	38	0.010	0.013	0.015	0.020	0.023	0.025	0.038	0.051
275 - 325		Difficult	38	0.010	0.013	0.015	0.020	0.023	0.025	0.038	0.051	
R	Cast Iron Grey, Ductile, Nodular	150 - 200	Difficult	99	0.010	0.013	0.018	0.023	0.025	0.038	0.051	0.064
		200 - 250	Difficult	69	0.010	0.013	0.018	0.023	0.025	0.038	0.051	0.064
		120 - 150	Easy	168	0.010	0.013	0.018	0.023	0.025	0.038	0.051	0.064
		150 - 200	Easy	152	0.010	0.013	0.018	0.023	0.025	0.038	0.051	0.064
		200 - 220	Easy	137	0.010	0.013	0.018	0.023	0.025	0.038	0.051	0.064
S	Wrought Aluminum 6061 T6	220 - 260	Average	122	0.010	0.013	0.018	0.023	0.025	0.038	0.051	0.064
		260 - 320	Average	114	0.010	0.013	0.018	0.023	0.025	0.038	0.051	0.064
		30	Easy	305	0.013	0.015	0.023	0.025	0.038	0.051	0.064	0.076
		180	Easy	274	0.013	0.015	0.023	0.025	0.038	0.051	0.064	0.076
		Cast Aluminum** up to 10% silicon	120	Easy	152	0.013	0.015	0.023	0.025	0.038	0.051	0.064
Brass	30 - 125	Easy	305	0.013	0.015	0.023	0.025	0.038	0.051	0.064	0.076	

NOTICE: Reduce feed and speed by 30% for tapered thread forms due to additional material removal

*Refer to recommended pass chart on page E: 45 when referencing material machinability

**Uncoated thread mills are recommended for cast aluminum applications

A DRILLING
B BORING
C REAMING
D BURNISHING
E THREADING
X SPECIALS

Recommended Cutting Data | Imperial (inch)

Indexable | AccuThread™ 856 | Positive Rake

ISO	Material	Hardness (BHN)	Machinability**	Speed (SFM)	Recommended Feed (inch/tooth) by Cutter Diameter						
					1 flute		1 and 2 flutes	3 flutes	5 flutes	7 flutes	8 flutes
					0.375 - 0.500	0.501 - 0.750	0.751 - 1.000	1.001 - 1.500	1.501 - 2.000	2.001 - 2.750	2.751 - 3.500
P	Free Machining Steel 1118, 1215, 12L14, etc.	100 - 150	Easy	900	0.0008	0.0010	0.0012	0.0015	0.0020	0.0025	0.0030
		150 - 200	Easy	700	0.0008	0.0010	0.0012	0.0015	0.0020	0.0025	0.0030
		200 - 250	Easy	500	0.0008	0.0010	0.0012	0.0015	0.0020	0.0025	0.0030
	Low Carbon Steel 1010, 1020, 1025, 1522, 1144	85 - 125	Average	900	0.0008	0.0010	0.0012	0.0015	0.0020	0.0025	0.0030
		125 - 175	Average	700	0.0008	0.0010	0.0012	0.0015	0.0020	0.0025	0.0030
		175 - 225	Average	600	0.0008	0.0010	0.0012	0.0015	0.0020	0.0025	0.0030
		225 - 275	Average	500	0.0008	0.0010	0.0012	0.0015	0.0020	0.0025	0.0030
	Medium Carbon Steel 1010, 1040, 1050, 1527, 1140	125 - 175	Average	575	0.0008	0.0009	0.0010	0.0012	0.0015	0.0020	0.0025
		175 - 225	Average	500	0.0008	0.0009	0.0010	0.0012	0.0015	0.0020	0.0025
		225 - 275	Average	450	0.0008	0.0009	0.0010	0.0012	0.0015	0.0020	0.0025
		275 - 325	Average	400	0.0008	0.0009	0.0010	0.0012	0.0015	0.0020	0.0025
	Alloy Steel 4140, 5140, 8640	125 - 175	Average	575	0.0008	0.0009	0.0010	0.0012	0.0015	0.0020	0.0025
		175 - 225	Average	500	0.0008	0.0009	0.0010	0.0012	0.0015	0.0020	0.0025
		225 - 275	Average	450	0.0008	0.0009	0.0010	0.0012	0.0015	0.0020	0.0025
		275 - 325	Difficult	400	0.0008	0.0009	0.0010	0.0012	0.0015	0.0020	0.0025
		325 - 375	Difficult	375	0.0008	0.0009	0.0010	0.0012	0.0015	0.0020	0.0025
	High Strength Alloy 4340, 4330V, 300M	225 - 300	Average	450	0.0008	0.0009	0.0010	0.0012	0.0015	0.0020	0.0025
		300 - 350	Difficult	400	0.0008	0.0009	0.0010	0.0012	0.0015	0.0020	0.0025
350 - 400		Difficult	350	0.0008	0.0009	0.0010	0.0012	0.0015	0.0020	0.0025	
Structural Steel A36, A285, A516	100 - 150	Average	600	0.0008	0.0010	0.0012	0.0015	0.0020	0.0025	0.0030	
	150 - 250	Average	500	0.0008	0.0010	0.0012	0.0015	0.0020	0.0025	0.0030	
	250 - 350	Difficult	450	0.0008	0.0010	0.0012	0.0015	0.0020	0.0025	0.0030	
S	High Temp Alloy Hastelloy B, Inconel 600	140 - 220	Difficult	120	0.0005	0.0006	0.0008	0.0010	0.0015	0.0020	0.0025
		220 - 310	Difficult	90	0.0005	0.0006	0.0008	0.0010	0.0015	0.0020	0.0025
M	Stainless Steel 303, 416, 420	135 - 185	Difficult	525	0.0005	0.0007	0.0009	0.0015	0.0020	0.0025	0.0030
		185 - 275	Difficult	500	0.0005	0.0007	0.0009	0.0015	0.0020	0.0025	0.0030
	Stainless Steel PH 17-4	185 - 275	Difficult	300	0.0005	0.0007	0.0009	0.0015	0.0020	0.0025	0.0030
		275 - 325	Difficult	150	0.0005	0.0007	0.0009	0.0015	0.0020	0.0025	0.0030
	Tool Steel H-13, H21, A-4	150 - 200	Difficult	575	0.0008	0.0010	0.0012	0.0015	0.0020	0.0025	0.0030
200 - 250		Difficult	500	0.0008	0.0010	0.0012	0.0015	0.0020	0.0025	0.0030	
K	Cast Iron Grey, Ductile, Nodular	120 - 150	Easy	675	0.0008	0.0012	0.0015	0.0020	0.0030	0.0040	0.0050
		150 - 200	Easy	625	0.0008	0.0012	0.0015	0.0020	0.0030	0.0040	0.0050
		200 - 220	Easy	575	0.0008	0.0012	0.0015	0.0020	0.0030	0.0040	0.0050
		220 - 260	Average	500	0.0008	0.0012	0.0015	0.0020	0.0030	0.0040	0.0050
		260 - 320	Average	475	0.0008	0.0012	0.0015	0.0020	0.0030	0.0040	0.0050
N	Wrought Aluminum 6061 T6	30	Easy	1100	0.0015	0.0020	0.0025	0.0030	0.0040	0.0050	0.0060
		180	Easy	1000	0.0015	0.0020	0.0025	0.0030	0.0040	0.0050	0.0060
	Cast Aluminum** up to 10% silicon	120	Easy	625	0.0015	0.0020	0.0025	0.0030	0.0040	0.0050	0.0060
	Brass	30 - 125	Easy	1100	0.0020	0.0025	0.0030	0.0040	0.0045	0.0055	0.0065

NOTICE: Reduce feed and speed by 30% for tapered thread forms due to additional material removal

*Refer to recommended pass chart on page E: 45 when referencing material machinability

**Uncoated thread mills are recommended for cast aluminum applications

Recommended Cutting Data | Metric (mm)

Indexable | AccuThread™ 856 | Positive Rake

ISO	Material	Hardness (BHN)	Machinability**	Speed (M/min)	Recommended Feed (mm/tooth) by Cutter Diameter						
					1 flute		1 and 2 flutes	3 flutes	5 flutes	7 flutes	8 flutes
					9.53 - 12.70	12.71 - 19.05	19.06 - 25.40	25.41 - 38.10	38.11 - 50.80	50.81 - 69.85	69.86 - 88.90
P	Free Machining Steel 1118, 1215, 12L14, etc.	100 - 150	Easy	274	0.020	0.025	0.030	0.038	0.051	0.064	0.076
		150 - 200	Easy	213	0.020	0.025	0.030	0.038	0.051	0.064	0.076
		200 - 250	Easy	152	0.020	0.025	0.030	0.038	0.051	0.064	0.076
	Low Carbon Steel 1010, 1020, 1025, 1522, 1144	85 - 125	Average	274	0.020	0.025	0.030	0.038	0.051	0.064	0.076
		125 - 175	Average	213	0.020	0.025	0.030	0.038	0.051	0.064	0.076
		175 - 225	Average	183	0.020	0.025	0.030	0.038	0.051	0.064	0.076
		225 - 275	Average	152	0.020	0.025	0.030	0.038	0.051	0.064	0.076
	Medium Carbon Steel 1010, 1040, 1050, 1527, 1140	125 - 175	Average	175	0.020	0.023	0.025	0.030	0.038	0.051	0.064
		175 - 225	Average	152	0.020	0.023	0.025	0.030	0.038	0.051	0.064
		225 - 275	Average	137	0.020	0.023	0.025	0.030	0.038	0.051	0.064
		275 - 325	Average	122	0.020	0.023	0.025	0.030	0.038	0.051	0.064
	Alloy Steel 4140, 5140, 8640	125 - 175	Average	175	0.020	0.023	0.025	0.030	0.038	0.051	0.064
		175 - 225	Average	152	0.020	0.023	0.025	0.030	0.038	0.051	0.064
		225 - 275	Average	137	0.020	0.023	0.025	0.030	0.038	0.051	0.064
		275 - 325	Difficult	122	0.020	0.023	0.025	0.030	0.038	0.051	0.064
		325 - 375	Difficult	114	0.020	0.023	0.025	0.030	0.038	0.051	0.064
	High Strength Alloy 4340, 4330V, 300M	225 - 300	Average	137	0.020	0.023	0.025	0.030	0.038	0.051	0.064
		300 - 350	Difficult	122	0.020	0.023	0.025	0.030	0.038	0.051	0.064
350 - 400		Difficult	107	0.020	0.023	0.025	0.030	0.038	0.051	0.064	
Structural Steel A36, A285, A516	100 - 150	Average	183	0.020	0.025	0.030	0.038	0.051	0.064	0.076	
	150 - 250	Average	152	0.020	0.025	0.030	0.038	0.051	0.064	0.076	
	250 - 350	Difficult	137	0.020	0.025	0.030	0.038	0.051	0.064	0.076	
S	High Temp Alloy Hastelloy B, Inconel 600	140 - 220	Difficult	37	0.013	0.015	0.020	0.025	0.038	0.051	0.064
		220 - 310	Difficult	27	0.013	0.015	0.020	0.025	0.038	0.051	0.064
M	Stainless Steel 303, 416, 420	135 - 185	Difficult	160	0.013	0.018	0.023	0.038	0.051	0.064	0.076
		185 - 275	Difficult	152	0.013	0.018	0.023	0.038	0.051	0.064	0.076
	Stainless Steel PH 17-4	185 - 275	Difficult	91	0.013	0.018	0.023	0.038	0.051	0.064	0.076
		275 - 325	Difficult	46	0.013	0.018	0.023	0.038	0.051	0.064	0.076
	Tool Steel H-13, H21, A-4	150 - 200	Difficult	175	0.020	0.025	0.030	0.038	0.051	0.064	0.076
200 - 250		Difficult	152	0.020	0.025	0.030	0.038	0.051	0.064	0.076	
K	Cast Iron Grey, Ductile, Nodular	120 - 150	Easy	206	0.020	0.030	0.038	0.051	0.076	0.102	0.127
		150 - 200	Easy	191	0.020	0.030	0.038	0.051	0.076	0.102	0.127
		200 - 220	Easy	175	0.020	0.030	0.038	0.051	0.076	0.102	0.127
		220 - 260	Average	152	0.020	0.030	0.038	0.051	0.076	0.102	0.127
		260 - 320	Average	145	0.020	0.030	0.038	0.051	0.076	0.102	0.127
N	Wrought Aluminum 6061 T6	30	Easy	335	0.038	0.051	0.064	0.076	0.102	0.127	0.152
		180	Easy	305	0.038	0.051	0.064	0.076	0.102	0.127	0.152
	Cast Aluminum** up to 10% silicon	120	Easy	191	0.038	0.051	0.064	0.076	0.102	0.127	0.152
	Brass	30 - 125	Easy	335	0.051	0.064	0.076	0.102	0.114	0.140	0.165

NOTICE: Reduce feed and speed by 30% for tapered thread forms due to additional material removal

*Refer to recommended pass chart on page E: 45 when referencing material machinability

**Uncoated thread mills are recommended for cast aluminum applications

A DRILLING
B BORING
C REAMING
D BURNISHING
E THREADING
X SPECIALS

Recommended Cutting Data | Imperial (inch)

Indexable | AccuThread™ 856 | Neutral Rake

ISO	Material	Hardness (BHN)	Machinability**	Speed (SFM)	Recommended Feed (inch/tooth) by Cutter Diameter		
					3 flutes 1.000 - 1.499	5 flutes 1.500 - 1.999	6 flutes 2.000 - 2.750
P	Free Machining Steel 1118, 1215, 12L14, etc.	100 - 150	Easy	765	0.0013	0.0017	0.0021
		150 - 200	Easy	595	0.0013	0.0017	0.0021
		200 - 250	Easy	425	0.0013	0.0017	0.0021
	Low Carbon Steel 1010, 1020, 1025, 1522, 1144	85 - 125	Average	765	0.0013	0.0017	0.0021
		125 - 175	Average	595	0.0013	0.0017	0.0021
		175 - 225	Average	510	0.0013	0.0017	0.0021
		225 - 275	Average	425	0.0013	0.0017	0.0021
	Medium Carbon Steel 1010, 1040, 1050, 1527, 1140	125 - 175	Average	490	0.0010	0.0013	0.0017
		175 - 225	Average	425	0.0010	0.0013	0.0017
		225 - 275	Average	380	0.0010	0.0013	0.0017
		275 - 325	Average	340	0.0010	0.0013	0.0017
	Alloy Steel 4140, 5140, 8640	125 - 175	Average	490	0.0010	0.0013	0.0017
		175 - 225	Average	425	0.0010	0.0013	0.0017
		225 - 275	Average	380	0.0010	0.0013	0.0017
		275 - 325	Difficult	340	0.0010	0.0013	0.0017
		325 - 375	Difficult	320	0.0010	0.0013	0.0017
	High Strength Alloy 4340, 4330V, 300M	225 - 300	Average	390	0.0010	0.0013	0.0017
		300 - 350	Difficult	340	0.0010	0.0013	0.0017
350 - 400		Difficult	300	0.0010	0.0013	0.0017	
Structural Steel A36, A285, A516	100 - 150	Average	510	0.0013	0.0017	0.0021	
	150 - 250	Average	425	0.0013	0.0017	0.0021	
	250 - 350	Difficult	390	0.0013	0.0017	0.0021	
S	High Temp Alloy Hastelloy B, Inconel 600	140 - 220	Difficult	-	-	-	
		220 - 310	Difficult	-	-	-	
M	Stainless Steel 303, 416, 420	135 - 185	Difficult	-	-	-	
		185 - 275	Difficult	-	-	-	
	Stainless Steel PH 17-4	185 - 275	Difficult	-	-	-	
		275 - 325	Difficult	-	-	-	
	Tool Steel H-13, H21, A-4	150 - 200	Difficult	-	-	-	
200 - 250		Difficult	-	-	-		
K	Cast Iron Grey, Ductile, Nodular	120 - 150	Easy	575	0.0017	0.0026	0.0034
		150 - 200	Easy	525	0.0017	0.0026	0.0034
		200 - 220	Easy	490	0.0017	0.0026	0.0034
		220 - 260	Average	425	0.0017	0.0026	0.0034
		260 - 320	Average	400	0.0017	0.0026	0.0034
N	Wrought Aluminum 6061 T6	30	Easy	-	-	-	
		180	Easy	-	-	-	
	Cast Aluminum** up to 10% silicon	120	Easy	-	-	-	
	Brass	30 - 125	Easy	-	-	-	

NOTICE: Reduce feed and speed by 30% for tapered thread forms due to additional material removal

*Refer to recommended pass chart on page E: 45 when referencing material machinability

**Uncoated thread mills are recommended for cast aluminum applications

Recommended Cutting Data | Metric (mm)

Indexable | AccuThread™ 856 | Neutral Rake

ISO	Material	Hardness (BHN)	Machinability**	Speed (M/min)	Recommended Feed (mm/tooth) by Cutter Diameter		
					3 flutes	5 flutes	6 flutes
					25.41 - 38.09	38.10 - 50.77	50.78 - 69.85
P	Free Machining Steel 1118, 1215, 12L14, etc.	100 - 150	Easy	233	0.032	0.043	0.054
		150 - 200	Easy	181	0.032	0.043	0.054
		200 - 250	Easy	129	0.032	0.043	0.054
	Low Carbon Steel 1010, 1020, 1025, 1522, 1144	85 - 125	Average	233	0.032	0.043	0.054
		125 - 175	Average	181	0.032	0.043	0.054
		175 - 225	Average	156	0.032	0.043	0.054
		225 - 275	Average	129	0.032	0.043	0.054
	Medium Carbon Steel 1010, 1040, 1050, 1527, 1140	125 - 175	Average	149	0.026	0.032	0.043
		175 - 225	Average	129	0.026	0.032	0.043
		225 - 275	Average	116	0.026	0.032	0.043
		275 - 325	Average	104	0.026	0.032	0.043
	Alloy Steel 4140, 5140, 8640	125 - 175	Average	149	0.026	0.032	0.043
		175 - 225	Average	129	0.026	0.032	0.043
		225 - 275	Average	116	0.026	0.032	0.043
		275 - 325	Difficult	104	0.026	0.032	0.043
		325 - 375	Difficult	97	0.026	0.032	0.043
	High Strength Alloy 4340, 4330V, 300M	225 - 300	Average	116	0.026	0.032	0.043
		300 - 350	Difficult	104	0.026	0.032	0.043
		350 - 400	Difficult	91	0.026	0.032	0.043
	Structural Steel A36, A285, A516	100 - 150	Average	156	0.032	0.043	0.054
		150 - 250	Average	129	0.032	0.043	0.054
250 - 350		Difficult	116	0.032	0.043	0.054	
S	High Temp Alloy Hastelloy B, Inconel 600	140 - 220	Difficult	-	-	-	
		220 - 310	Difficult	-	-	-	
M	Stainless Steel 303, 416, 420	135 - 185	Difficult	-	-	-	
		185 - 275	Difficult	-	-	-	
	Stainless Steel PH 17-4	185 - 275	Difficult	-	-	-	
		275 - 325	Difficult	-	-	-	
	Tool Steel H-13, H21, A-4	150 - 200	Difficult	-	-	-	
200 - 250		Difficult	-	-	-		
K	Cast Iron Grey, Ductile, Nodular	120 - 150	Easy	175	0.043	0.065	0.087
		150 - 200	Easy	162	0.043	0.065	0.087
		200 - 220	Easy	149	0.043	0.065	0.087
		220 - 260	Average	129	0.043	0.065	0.087
		260 - 320	Average	123	0.043	0.065	0.087
N	Wrought Aluminum 6061 T6	30	Easy	-	-	-	
		180	Easy	-	-	-	
	Cast Aluminum** up to 10% silicon	120	Easy	-	-	-	
	Brass	30 - 125	Easy	-	-	-	

NOTICE: Reduce feed and speed by 30% for tapered thread forms due to additional material removal

*Refer to recommended pass chart on page E: 45 when referencing material machinability

**Uncoated thread mills are recommended for cast aluminum applications

Thread Mill Programming Guide

What you need to know

- Thread milling can be easily accomplished with simple G code programming
- If your machine is capable of 3 axis (helical) interpolation, you can and **should** be thread milling
- Basic programming of a one pass thread mill can be achieved in 6 basic steps

AVAILABLE ONLINE 24/7
or download INSTA-CODE™

visit www.alliedmachine.com

The following are examples of how to calculate and program a 7/16-20 right hand thread that will be 1/2 deep produced in one pass

Major thread diameter	0.4375	Major diameter of thread (7/16 = 0.4375)
Threads per inch	20	Number of threads per inch (20 is from 7/16-20 designation)
Length of thread	0.5	Desired length of cut
SFM	475	Recommended surface footage for material to be cut
Feed per flute	0.0025	Recommended feed rate per cutting edge
Number of flutes	4	Number of flutes on tool to be used
Tool diameter	0.335	Diameter of cutting tool
Using the information above, the values can be calculated:		
Pitch	0.05	= 1 / thread per inch
RPM	5416	(SFM • 3.82) / Tool diameter
Linear feed	54.16	RPM • Feed per flute • Number of flutes
Feed rate for thread milling	12.69	Linear feed • ((Major thread diameter - Tool diameter) / Major thread diameter)
Z axis move on arc on	0.0063	(Pitch / 8)
Z axis move for full thread	0.5063	(Pitch / 8) + Length of cut
Arc on/off	0.0256	(Major thread diameter - Tool diameter) / 4
Full rotation value	0.05125	(Major thread diameter - Tool diameter) / 2

Major thread diameter	0.4375
Cutter diameter	0.335
Length of thread	0.5

Feed rate for thread milling	12.69
Z axis depth for full thread	0.5063
Z axis for arc on/off	0.0063

Arc on/off value	0.0256
Full rotation value	0.05125
Pitch value	0.05

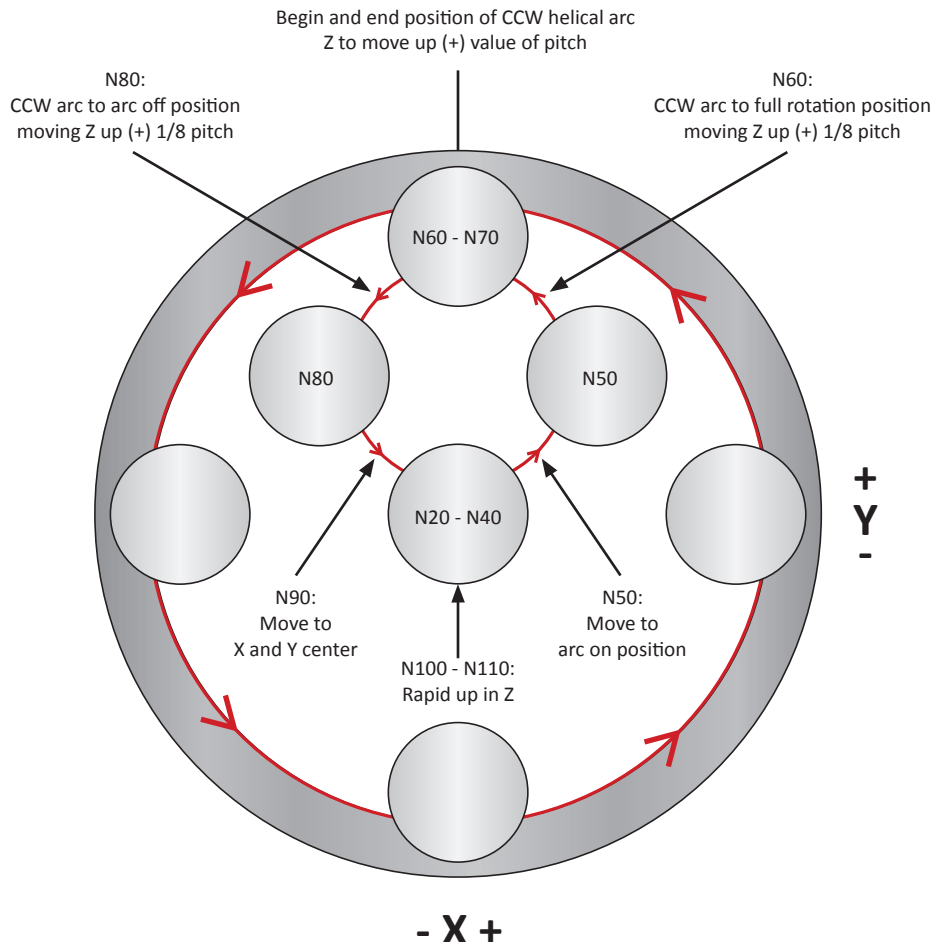

1	N10	S	5416 M03				Absolute position in rapid to center of hole in X and Y, then rapid to Z0 (level with surface of hole)(assumed to be X0, Y0, Z0 for demonstration purposes). To be done by customer.		
	N20	G90	G00	X 0.0000	Y 0.0000				
	N30					Z 0.0000			
2	N 40	G91	G01		Z -0.5063	F 50.0			
	Switch to incremental positioning and high feed to Z axis depth for full thread.								
3	N50	G41	G01	X 0.0256	Y 0.0256	D1	F 3.17		
	Activate left diameter compensation for tool number 1 (needs to be whatever tool number you are using) and feed to arc on/off position at 1/4 feed rate for thread milling.								
	N60	G03	X -0.0256	Y 0.0256	Z 0.0063	I -0.0256	J 0.0000	F 12.69	
CCW arc from full rotation from the arc on position at the calculated thread milling feed rate moving Z up (+) 1/8 pitch value (Z axis move up for arc on/off). X and Y positions are the incremental distance from where tool is to where it will be after arc (arc on/off value). I is the incremental X value of center of rotation from where tool currently is arc on/off value *-1. J is the incremental Y value from current tool position to center of rotation.									
4	N70	G03	X 0.0000	Y 0.0000	Z 0.0500	I 0.0000	J -0.0513	F 12.69	
	One complete CCW arc from the full arc rotation position at the calculated thread milling feed rate moving Z up (positive pitch value). I and J values are calculated same as above. I will be 0.0 and J will be full rotation value *-1.								
5	N80	G03	X -0.0256	Y -0.0256	Z 0.0063	I 0.0000	J -0.0256	F 25.38	
	CCW arc from full rotation diameter to arc off position at double the calculated thread milling feed rate moving Z up (+) 1/8 pitch value (Z axis move up for arc on/off). I and J values are calculated same as above.								
	N90	G40	G01	X 0.0256	Y -0.0256				
Shut off cutter comp and move from arc off position to center of hole in X (arc on/off value -1) and Y (arc on/off value *-1) at high feed rate.									
6	N100	G00				Z 0.4438			
	Rapid Z up incremental value (length of thread - all Z values in G03 arc commands).								
	N110	G90	G00		Z 1.0000				
Switch back to absolute positioning and rapid to a safe point in Z above part level (assumed to be 1 above part level for demonstration purposes).									

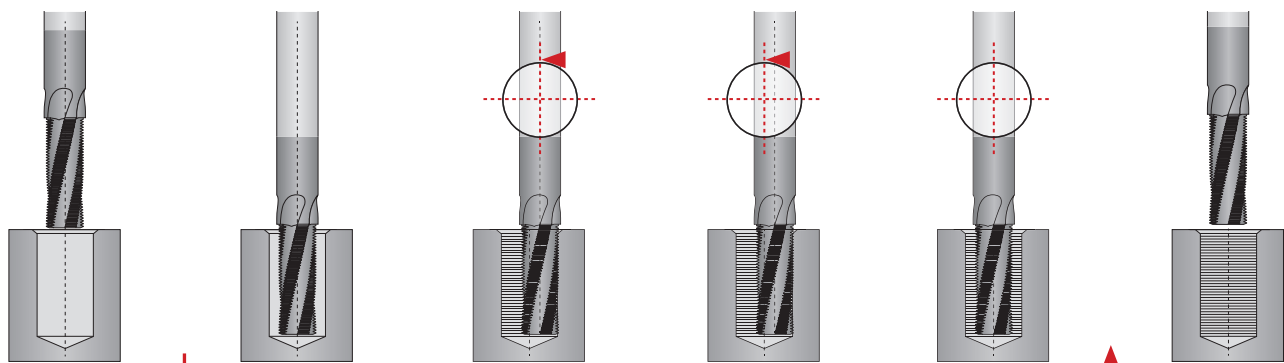

Step 1 N10 - N30	Step 2 N40	Step 3 N50 - N60	Step 4 N70	Step 5 N80 - N90	Step 6 N100 - N110
<ul style="list-style-type: none"> Preparatory commands Positioning above hole center and at hole level in Z In absolute position mode 	<ul style="list-style-type: none"> Change to incremental Feed to bottom of hole Z axis depth for full thread 	<ul style="list-style-type: none"> Activate left cutter comp Feed to arc on position Arc to full rotation value while moving Z up 1/8 pitch Z axis move for arc on 	<ul style="list-style-type: none"> One complete CCW rotation at full arc rotation value while moving Z up 1 pitch value 	<ul style="list-style-type: none"> CCW arc from full rotation value to the arc on/off value while moving Z up 1/8 pitch (Z axis move for arc off) 	<ul style="list-style-type: none"> Rapid up in Z

A DRILLING
B BORING
C REAMING
D BURNISHING
E THREADING
X SPECIALS

Thread Mill Troubleshooting Guide

		Problem										
		Thread mill is showing accelerated or excessive wear	Cutting edges are chipping	Thread mill is breaking in the first hole of part	Thread mill is creating excessive chatter	Out of round thread is produced	Bell mouthed thread form (small at bottom, big at top)	Part rejection because of rough flank finish	Steps in thread profile	Gauge difference from part to part	Machine not making correct paths to create thread profile	Control not accepting the program
Causes												
Catalog	Incorrect tool selection			1	1							
	Incorrect speed and feed selection	2, 3	2, 3		2, 3			2, 3				
Speed and Feed	RPM too high	5										
	RPM too low				4		4	4				
	Machine tool specifications restrict RPMs			5, 19								
	Feed rate too high		7	7			7	7	7			
	Feed rate too low	6										
	Incorrect adjusted feed rate adjustment ratio			12								
	Machine tool specification restricts feed rate					7, 19						
	Ramp-in is programmed as an axial move			20					20			
Tool	Thread mill moved or slipped in its holding device	13	13	13	13			13	13			
	Tool is sticking out of the holder too far	15	15	15	15			15	15	15		
	Runout between thread mill and holder				10			10				
	Incorrect coating creating built up edge	8, 17								8, 17		
	Helix angle too low				9			9				
	Excessive thread mill wear								11	11		
	Excessive tool pressure	7, 11, 14						7, 11, 14				
Machine	Workpiece moving in its fixturing	16	16	16	16			16		16		
	Insufficient coolant pressure or flow	17	17									
	Lack of machine rigidity	16	16		16		16	16				
Programming	Incorrect number of passes			22			22					
	Incorrect program variables			18, 26							18, 26	
	Did not account for X/Y radial moves for tapered threads										24, 26	
	Incorrect cutter compensation variables			23, 26								23, 26
	Helical interpolation option not on machine or turned off										21, 26	21, 26
	Machine tool control is not formatted to standard EIA/ASCII/ISO Code											25, 26

Troubleshooting Solutions

1. Refer to catalog to ensure proper tool selection.
2. Verify the correct speed was selected from the catalog speed and feed chart.
3. Verify the correct feed rate was selected from the catalog speed and feed chart.
4. Increase the spindle speed (RPM).
5. Decrease the spindle speed (RPM).
6. Increase feed per tooth.
7. Decrease feed per tooth.
8. Investigate other coatings.
9. Increase the tool helix.
10. Gauge runout between thread mill and tool holder.
11. Perform tool change at quicker intervals.
12. Adjust the feed rate ratio properly to the correct actual penetration rate for internal threads. Refer to speed and feed pages for formula.
13. Use hydraulic clamping chuck.
14. Check the tool for excessive wear. Beginning threads will wear the fastest.
15. Make the amount of overhang in the holding device as short as possible.
16. Verify the workpiece is properly clamped. Re-tighten or increase stability if necessary.
17. Increase the coolant flow and volume.
18. Check the milling program variables, especially the positive or negative value associated with I and J values.
19. Make sure the machine has the appropriate axis and path speed capabilities.
20. Make sure the thread mill is arcing in the major diameter instead of making a radial move.
21. Make sure the machine tool has a helical interpolation option that is on.
22. Increase the number of thread mill passes.
23. Make sure the cutter compensation variables are input into the G41 program line.
24. Adjust the program for pipe tap threads to taper out on diameter in X/Y directions to create proper form.
25. Request information from the machine tool builder regarding its programming formats.
26. Scan and email a copy of your program to the Application Engineering department at appeng@alliedmachine.com.

Special Tooling Solutions

Superion™ | Insta-Quote™ | Engineered Specials



Specialty is Our Specialty

It's true. When it comes to designing and developing special solutions for customers, Allied Machine is the top choice. Our engineers see applications in ways many others don't, and that ability allows us to win situations that haven't been won before.

If you have a particularly unique or difficult application, give us a call. Most of our tooling can be tweaked as specials, and we can create entirely new concepts if alterations to standard product won't do the trick.

After all, everyone deserves some special attention.



Your safety and the safety of others is very important. This catalog contains important safety messages. Always read and follow all safety precautions.



This triangle is a safety hazard symbol. It alerts you to potential safety hazards that can cause tool failure and serious injury.

When you see this symbol in the catalog, look for a related safety message that may be near this triangle or referred to in the nearby text.

There are safety signal words also used in the catalog. Safety messages follow these words.

WARNING

WARNING (shown above) means that failure to follow the precautions in this message could result in tool failure and serious injury.

NOTICE means that failure to follow the precautions in this message could result in damage to the tool or machine but not result in personal injury.

NOTE and **IMPORTANT** are also used. These are important that you read and follow but are not safety-related.

Visit www.alliedmachine.com for the most up-to-date information and procedures.

Special Tooling Solutions Contents

Introduction Information

Overview of Specials Capabilities 2 - 3

Superion™ 4 - 5

Insta-Quote™

Program Overview 6

User Guide 7 - 9

T-A® Inserts 10

T-A® Holders 11

GEN3SYS® XT Holders 12

ALVAN® Reamers 13

Engineered Specials

Insert Designs 14

Vaccum Drill 15

Stealth Drill 16

Success Stories 17

i-Form 18 - 19

Special Design Examples 20 - 21

QDSI® Inserts 22 - 23

Send in Your Own Design 24 - 25

Deep Hole Drilling Guidelines 26

Special Tooling Options

Special Tooling is Our Specialty

Allied Machine offers three methods for obtaining special tooling to solve any application problem you encounter: Superion™, Insta-Quote™, and Engineered Specials. We know standard tooling can't be the answer for everyone, and that's why we specialize in developing unique tooling to fit your needs.

Many of our products can be altered as specials. In fact, many of our standard items are results of frequently requested special features. Many times, one special design can end up solving problems for multiple customers across a variety of industries. Our specials capabilities truly sets us apart from our competition.

Our Application Engineering team and Field Sales Engineers are trained and highly skilled to develop unique solutions that you won't find anywhere else. If you need special tooling, give us a call. Let us be the ones to tell you it can't be done. But don't expect us to.

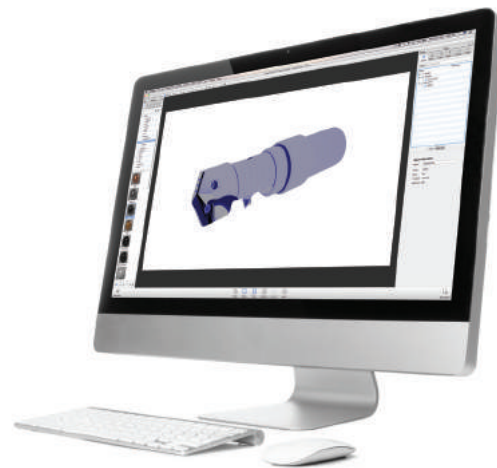

Advanced Capabilities

With the addition of the Superion™ solid carbide products, Allied Machine can now provide made-to-order special tooling to better help customers achieve optimal performance and productivity in their holemaking applications. Give us a call today and see the new solutions we can provide.

Made-to-Order Solid Carbide Specials

- PCD Tooling
- Burnishing Drills
- Solid Carbide Drills
- Carbide / PCD Step Reamers



Solid Carbide Specials

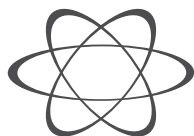

Insta-Quote™

Insta-Quote is an online custom tool designer. The program is available 24/7 and guides you through the steps as you create a special tool designed to meet the requirements of your application.

Products Available:

- T-A® Inserts
- T-A® Holders
- GEN3SYS® XT Holders
- ALVAN® Reamers



See pages X: 6 - 13



Engineered Specials

When the requirements of your application fall outside the limitations of Insta-Quote, your special tooling becomes an Engineered Special. These are tool designs that our engineers get to create and develop specifically for you.

Reasons to Call:

- Many standard products can be specially engineered
- Allied Machine specials can save you time and increase tool life
- Our engineers have the skills and knowledge to create designs that meet the challenge



See pages X: 14 - 21

Industry Solutions

Every Industry Needs Some Special Attention

Many specific industry applications can be tricky, and processes can change drastically from one sector to the next. Allied's Field Sales Engineers and Application Engineers work together to develop breakthrough solutions that help customers master processes that before seemed impossible to improve.

You know your parts. You know your materials. You know what works and what doesn't. All you need to do is let us know what you're dealing with, and we'll take it from there. Whether you're machining the wings of an airplane or the engine block in a new car, we'll develop the right design to solve the problem you're facing.

For more industry examples, see Allied Machine's Case Studies and Success Stories at www.alliedmachine.com/RealLifeResults.

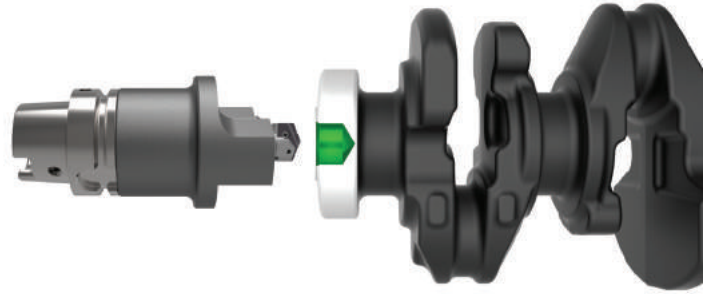

Automotive
Engine Block



Aerospace
Central Fuselage Wing Box



Heavy Machinery
Track Links



Oil and Gas
Heat Exchanger

COMPLEX SOLUTIONS

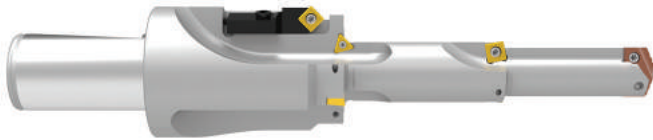

INNOVATIVE SOLUTIONS



LONG SOLUTIONS

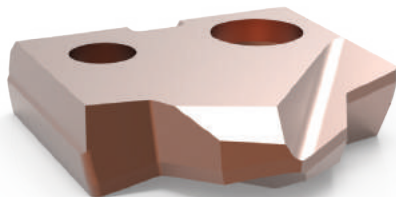

EVERY PROBLEM
HAS A
SOLUTION

Superion™

Solid Carbide Special Capabilities



a solid combination

Providing New Capabilities

With the acquisition of Superion, Inc., Allied Machine has gained the ability to provide top-of-the-line solid carbide special tooling. Superion has built its reputation as a manufacturer of innovative special solid carbide and PCD tipped rotary cutting tools such as:

- PCD Tools
- Reamers
- Drills
- Step Tools

Superion is widely recognized as the expert in developing customized solutions in specialty tooling. And now Allied Machine is bringing that expertise to you.



SOLID CARBIDE SPECIALS

PCD Tooling | Burnishing Drills | Solid Carbide Drills | Carbide / PCD Step Reamers

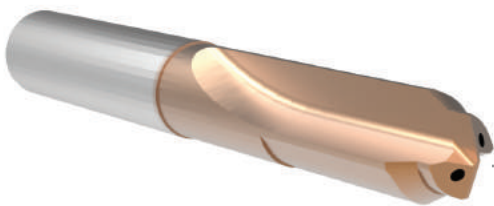

FORM DRILL

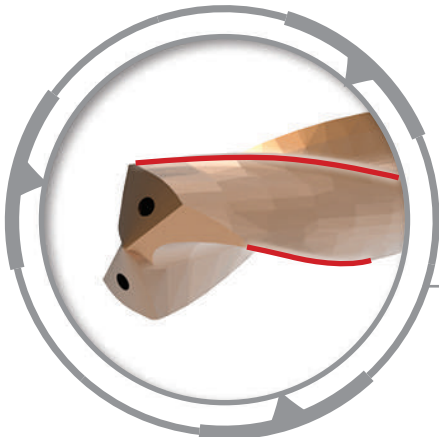
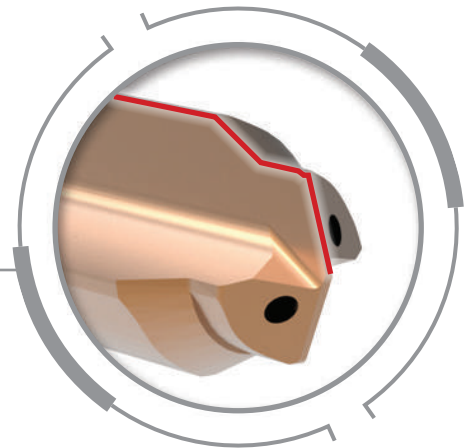

DOUBLE MARGIN



A DRILLING
B BORING
C REAMING
D BURNISHING
E THREADING
X SPECIALS

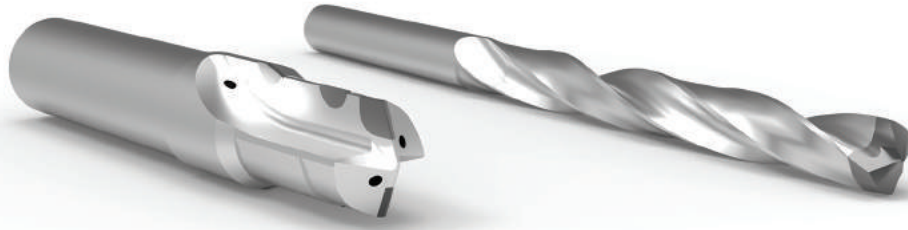

01 PCD DRILLS



Industry Application
Aerospace



Industry Application
Automotive

Wafer Style

- Wide diameter range of 3mm - 50mm
- Can be designed with multiple steps
- Can be designed with coolant through

Solid Head Style

- Diameter range of 3mm - 16mm
- Available with PCD to the center of the tool
- Can be reground

Aerospace

- Solid head PCD tools are used in composite materials (CFRP)
- Wafer tools are used for aluminum applications



02 SOLID CARBIDE DRILLS



Industry Application
Firearms



Industry Application
Automotive



Industry Application
Aerospace

Diameter | 25xD

- Wide diameter range of 3mm - 50mm
- Depth-to-diameter ratio up to 25xD

Multi-Step

- Can be designed with multiple steps
- Reduces cost per hole by eliminating tool changes

Automotive | Firearm

- Customized solutions available for the automotive, firearm, and aerospace industries



03 BURNISHING DRILLS



Industry Application
Aerospace



Industry Application
Automotive

Range

- Wide diameter range of 3mm - 50mm

Design

- Straight flutes, thinned web, four margins
- Available with or without coolant

Materials

- Specifically designed for cast iron and aluminum applications
- Produces rounder, more consistent holes

Insta-Quote™

Design Your Custom Tooling



Design your custom tooling and receive a drawing and quote...all within *minutes*.

iq.alliedmachine.com

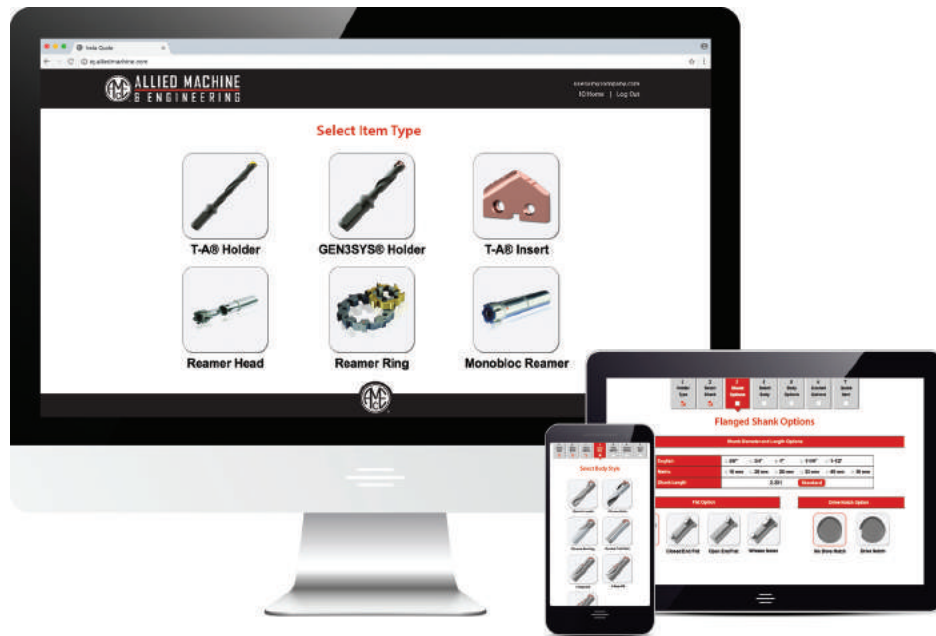

Design Your Own Solutions

Insta-Quote is an online program that allows you to design and quote your own tooling in a matter of minutes. After you log in, Insta-Quote will guide you through the steps to gather all the necessary information and generate the solution you need. Within the system, you can choose from the following tools to design:

- T-A® Inserts
- T-A® Holders
- GEN3SYS® XT Holders

Along with designing these products as specials, Insta-Quote can also help you create your item number for ALVAN® Reamers. Because reamer item numbers do not follow the same method as Allied Machine's standard products, you must build your reamer item numbers. Insta-Quote can do that for you.

- Replaceable Head Style
- Monobloc Style
- Cutting Ring Style



Design anytime from anywhere.
Available online 24/7.



Insta-Quote™

User Guide



Where Do I Find Insta-Quote?

There are two ways to get to the Insta-Quote program. You can visit the Allied Machine homepage (www.alliedmachine.com) and click on the Insta-Quote icon under the quick links menu (☰)

Or, you can simply go to iq.alliedmachine.com to access Insta-Quote directly.

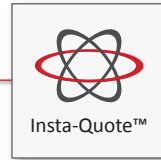

OR iq.alliedmachine.com

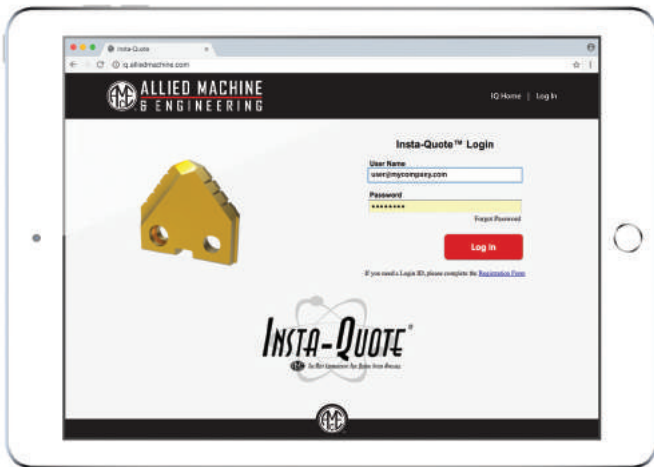

1

Log In

Fill in "User Name" and "Password" and click the login button. If you do not have a login, just click the "Registration Form" option beneath the log in button and submit your registration.



2

Select Activity

On this screen, you can choose to create a new tool, edit a previous tool, update your quote, or copy a previous item.

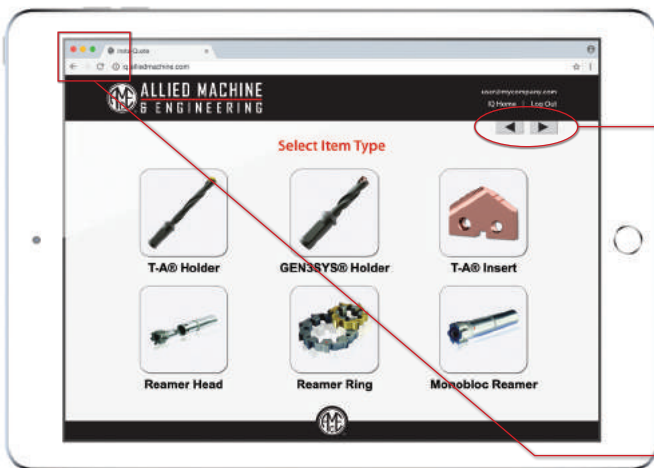

3

Select Tool Type

Choose the type of special tool you would like to create. The options include T-A® inserts, T-A® holders, GEN3SYS® holders, replaceable head reamers, monobloc reamers, and cutting ring reamers.



IMPORTANT:

The right and left arrows will navigate you through each step. **DO NOT** use the web browser's back and forward buttons; doing so may result in loss of progress.

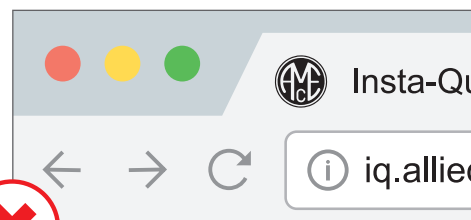

Do not use the web browser's back and forward arrows

What is My Item Number?

As soon as you select the type of product you want to design, Insta-Quote automatically generates the item number for your tool. The item number will appear at the top left-hand side of your screen.

170209-547

Year Month Day Reference No.

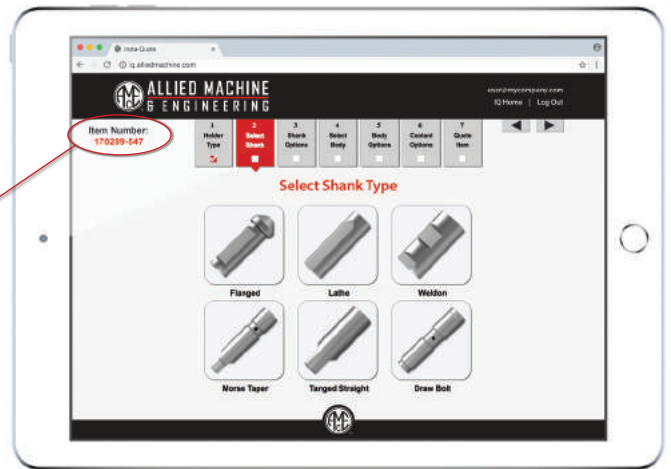

4

Shank Selection

Select the shank type you require and then click the right arrow button ► to proceed.

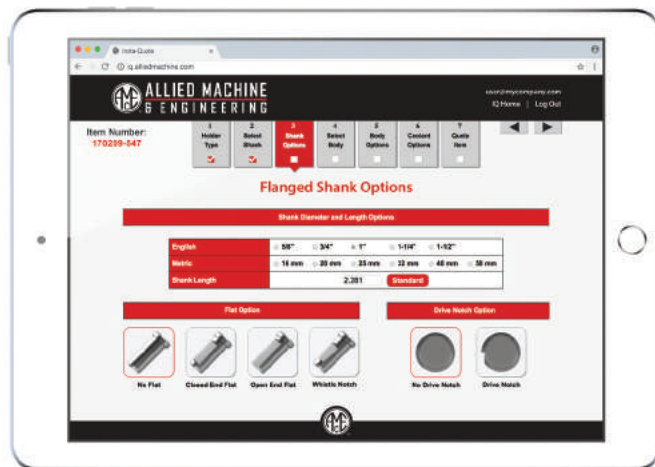

5

Shank Options

After choosing the shank type, you will be provided with additional shank options (if applicable). Once your selections are made, click the right arrow button ► to proceed.

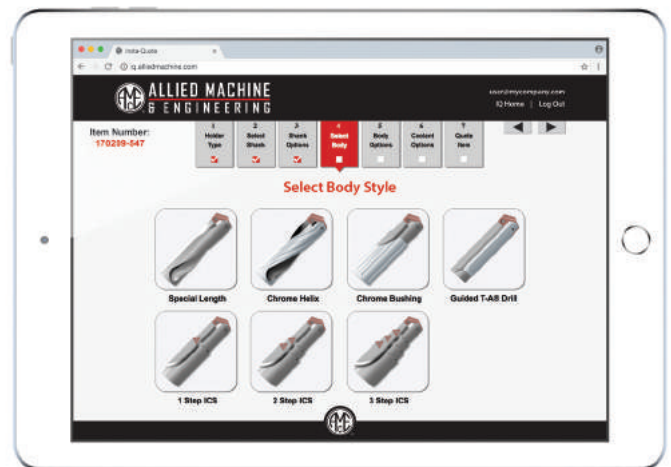

6

Select Body Style

Choose the holder style you need, and then click the right arrow button ► to proceed.

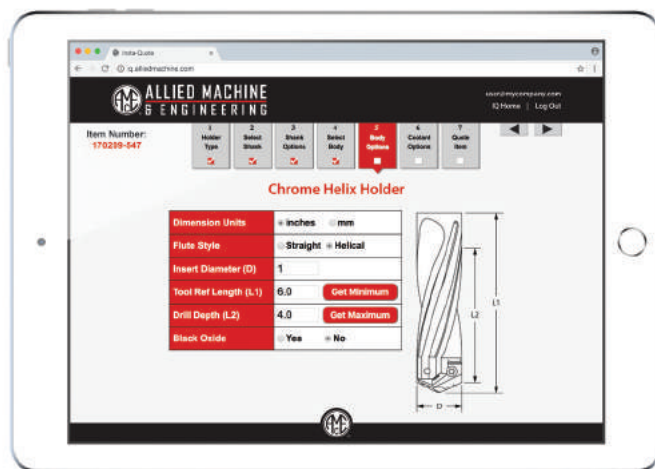

7

Body Options

After choosing the holder style, you will be provided with additional holder options (if applicable). Once your selections are made, click the right arrow button ► to proceed.

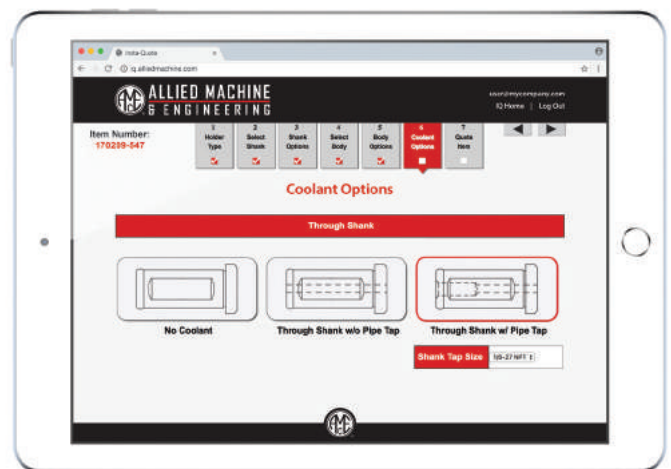

8

Coolant Options

On this screen you will select your coolant options. When finished, click the right arrow button ► to proceed.

A DRILLING

B BORING

C REAMING

D BURNISHING

E THREADING

X SPECIALS

Insta-Quote™ Custom Tooling

T-A® Inserts

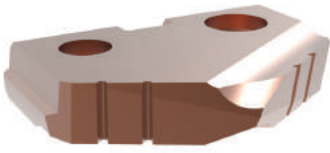

Special Angle

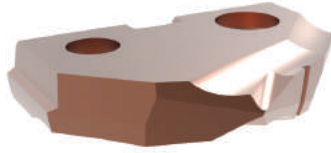

Double Angle

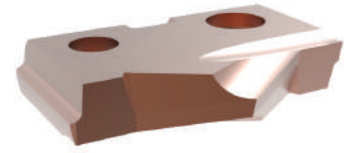

Spur Point

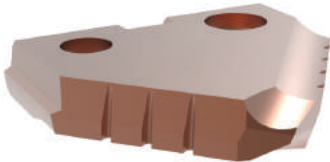

Spot and Chamfer

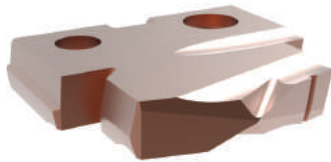

Step Insert

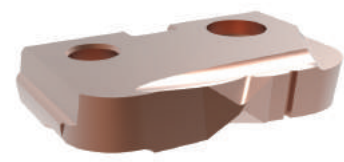

Flat Bottom

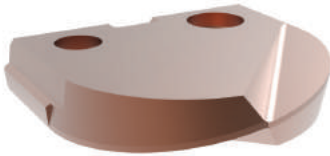

Ball Nose

Insta-Quote™ 

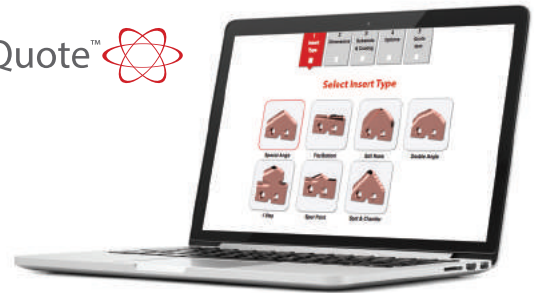

Additional Features

Insta-Quote provides multiple options to enhance different areas of the insert. If you have questions about which options would most benefit your application, just give us a call. We'll be happy to provide in-depth explanations about how certain options can optimize your results.

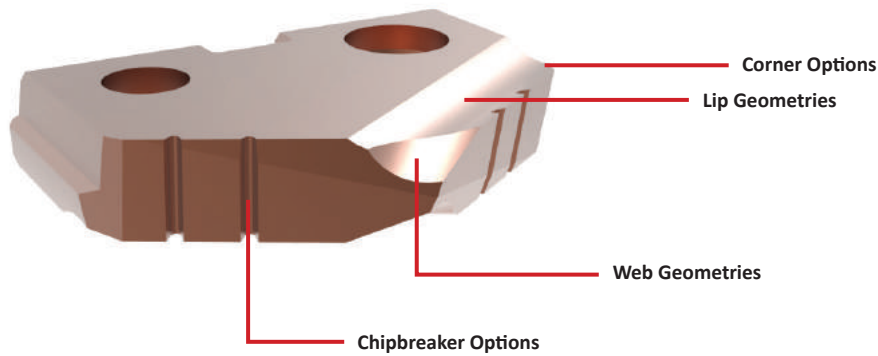

Substrate Options

HSS:
Super Cobalt, Premium Cobalt

Carbide:
C1, C2, C3, C5

Coating Options

AM200®

TiN

TiAlN

TiCN



A DRILLING
B BORING
C REAMING
D BURNISHING
E THREADING
X SPECIALS

Insta-Quote™ Custom Tooling

T-A® Holders



Chrome Helix



Chrome Bushing



 Guided Holder



One Step ICS



Two Step ICS



Three Step ICS



 Special Length

Insta-Quote™ 

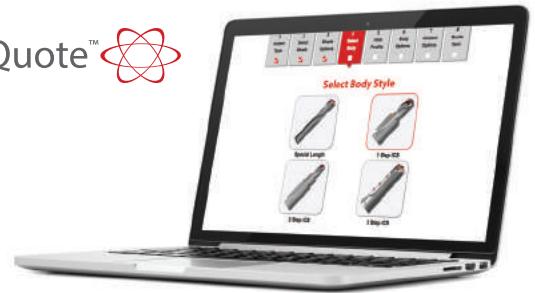

Additional Features

Insta-Quote provides multiple options to enhance different parts of the holder. If you have questions about which options would most benefit your application, just give us a call. We'll be happy to provide in-depth explanations about how certain options can optimize your results.

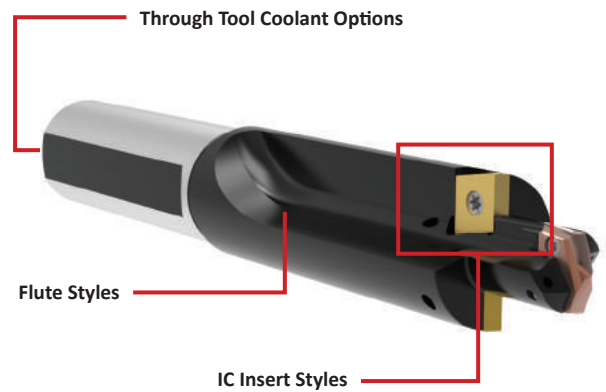

WARNING Refer to Speed and Feed charts for recommended adjustments to speeds and feeds. Refer to page X: 26 for deep hole drilling guidelines in this section of the catalog. Visit www.alliedmachine.com/DeepHoleGuidelines for the most up-to-date information and procedures. Factory technical assistance is available for your specific applications through our Application Engineering Team.

Insta-Quote™ Custom Tooling

GEN3SYS® XT Holders

A DRILLING
B BORING
C REAMING
D BURNISHING
E THREADING
X SPECIALS



Chrome Helix



Chrome Bushing



⚠ Special Length



One Step ICS

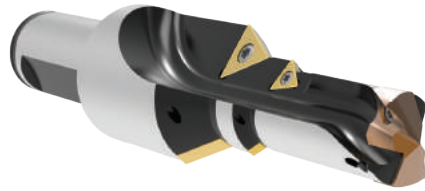

Two Step ICS



Three Step ICS

Additional Features

Insta-Quote provides multiple options to enhance different parts of the holder. If you have questions about which options would most benefit your application, just give us a call. We'll be happy to provide in-depth explanations about how certain options can optimize your results.

Insta-Quote™

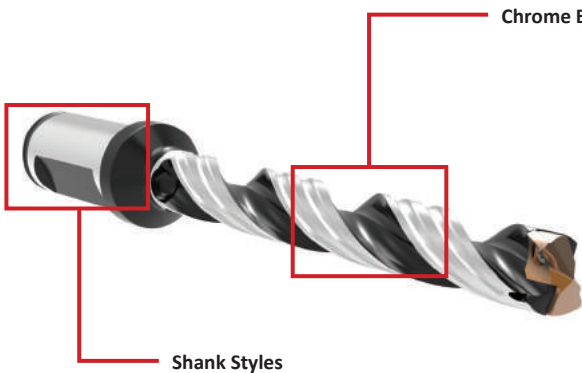
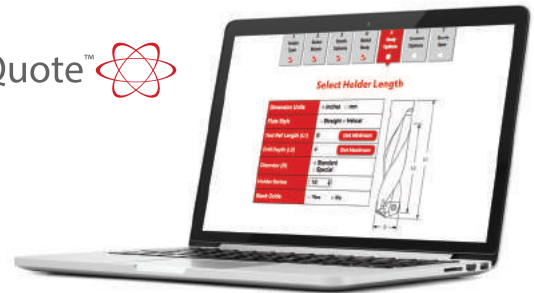

Chrome Bearing Areas

Shank Styles

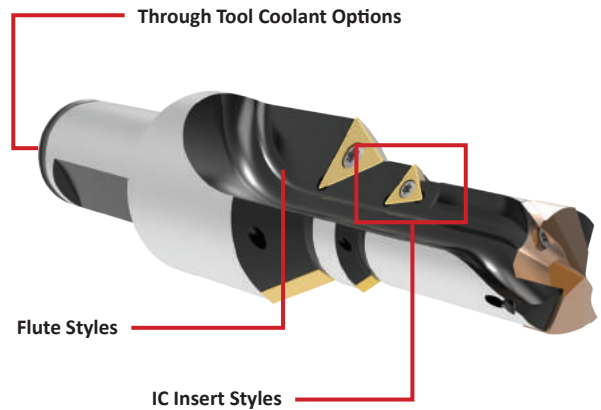

Through Tool Coolant Options

Flute Styles

IC Insert Styles

Where are the Inserts?

Though Insta-Quote incorporates special designs for GEN3SYS XT holders, it does not include options for designing special GEN3SYS XT inserts. GEN3SYS XT holders utilize standard GEN3SYS XT inserts, which can be found in Section A20 of the product catalog.

If you need a special insert, or would simply like to discuss options for designing one to fit your application, please contact us and we can create a special design as an engineered special.

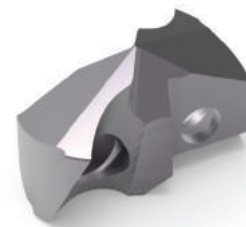

Engineered Special
GEN3SYS XT insert designed for specific aerospace application

⚠ WARNING Refer to Speed and Feed charts for recommended adjustments to speeds and feeds. Refer to page X: 26 for deep hole drilling guidelines in this section of the catalog. Visit www.alliedmachine.com/DeepHoleGuidelines for the most up-to-date information and procedures. Factory technical assistance is available for your specific applications through our Application Engineering Team.

Insta-Quote™ Custom Tooling

ALVAN® Reamers



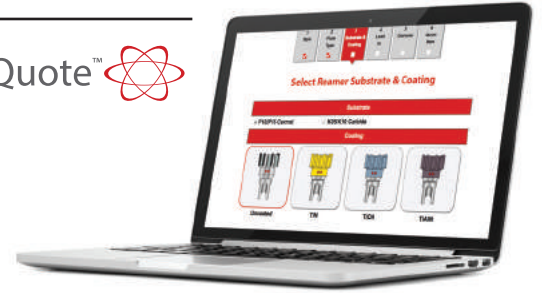

Use Insta-Quote to Build Your Part Numbers

Insta-Quote can help you find or build the ALVAN® Reamer item numbers you need along with the price and delivery of the items. It can also give you the recondition item and delivery. Just follow the steps, and Insta-Quote will guide you through the process.



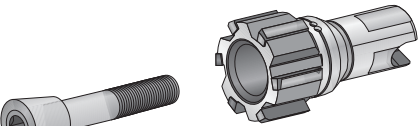
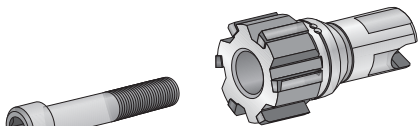
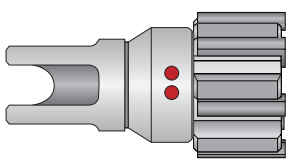
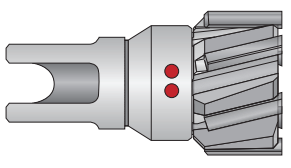

Insta-Quote™ 





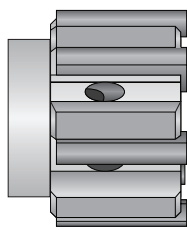
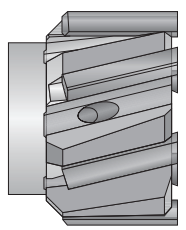

Replaceable Head Style

Diameter Options	Flute Options	Coating Options
 <p>Expandable Diameter</p>  <p>Fixed Diameter</p>	<p>Straight Flute</p>  <p>Left Hand Helical Flute</p> 	<p>Uncoated</p>  <p>TiN</p>  <p>TiAlN</p>  <p>TiCN</p> 

Monobloc Style

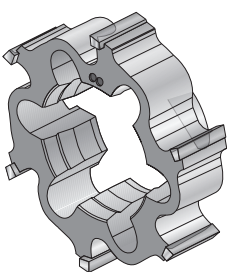
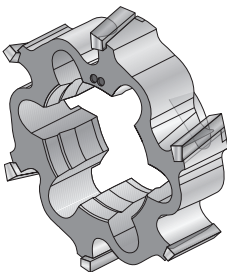
Flute Options	Coating Options
 <p>Straight Flute</p>  <p>Left Hand Helical Flute</p>	<p>Uncoated</p>  <p>TiN</p>  <p>TiAlN</p>  <p>TiCN</p> 

Cutting Ring Style

Flute Options	Coating Options
 <p>Straight Flute</p>  <p>Left Hand Helical Flute</p>	<p>Uncoated</p>  <p>TiN</p>  <p>TiAlN</p>  <p>TiCN</p> 

Engineered Specials

Insert Designs

Infinite Solutions

Though Insta-Quote™ and i-Form are incredible special tooling systems, some applications require a deeper level of engineering to accomplish the optimal results. No matter what the application may be, Allied Machine engineers have the knowledge, experience, and expertise to design and develop a special product to exceed your expectations.

Engineered Specials are not limited to T-A® or GEN3SYS® XT products. In fact, Engineered Specials can be created for most products offered by Allied Machine, including APX Drill, Opening Drill®, ASC 320®, AccuThread™ 856, Wohlhaupter® boring products, and many other product families.



Multiple Step



Special Point



Non-Center Cutting and Chamfer



Back Chamfer

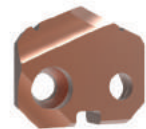

Back Chamfer with Chipbreakers



Flat Fottom with Pilot, Corner Radius, and Chamfer



Special Step



Non-Center Cutting and Chamfer



Back chamfer



Non-Center Cutting and Chamfer

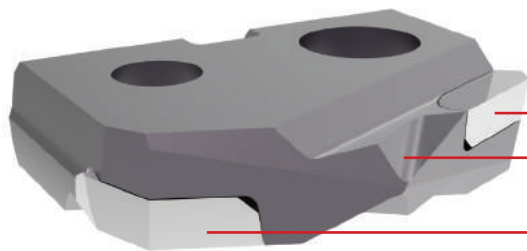

PCD Tip

Notch Point® Geometry

PCD Tip

The Proof is in the Numbers

See the following results from a customer who was experiencing difficulty when drilling CFRP material:

- The fibers are characterized by high strength
- The material is difficult to cut, which wears down the cutting tool and causes splintering and/or fraying
- The plastic matrix is sensitive to heat and will melt
- The structure is built up by layers of material, which results in delamination upon exit

INCREASED tool life by **80%**

T-A® PCD Diamond Tipped Insert: Why PCD?

What allows the PCD (polycrystalline diamond) insert to generate such great success is the sharp cutting edge made for extreme wear resistance. While other tools encounter massive tearing when exiting, the PCD insert geometry, along with precise OD corner prep and Notch Point® technology, encounters minimal delamination. This produces an almost perfect tight tolerance and smooth hole.

Insert Highlights

- C3 carbide substrate increases tool life
- PCD tip is designed for carbon fiber reinforced polymer (CFRP) material
- Notch Point® geometry, special corner clip, and drill point angle help minimize delamination upon exiting the hole



Industry Application
Aerospace

Number of Holes Drilled: ONE Competing Insert



Number of Holes Drilled: ONE PCD Tipped T-A Insert

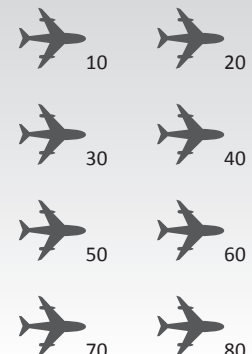

Engineered Specials

Featured Design | GEN3SYS® XT Vacuum Drill



Vacuum Drill Highlights

- Keeps material contained in a sealed vacuum system
- Provides mobile ability to perform operations away from a stationary machine tool
- Eliminates operation limitations
- There is a range of diameters per holder
- The same holder can be used for different material specific inserts



Industry Application
Aerospace



Tight tolerance body diameter to run through a drill bushing

Spent coolant and chips are evacuated through an internal flute

Replaceable insert for quick and easy changes

Carbon-Fiber-Reinforced Polymers (CFRP)

These are composite materials consisting of two parts: a matrix and a reinforcement (carbon fiber). Unlike isotropic materials like steel and aluminum, CFRP has directional strength properties, which depend on the layouts of the carbon fiber and the proportion of the carbon fibers in relation to the polymer.

Drilling in CFRP

- These applications are run with the vacuum only, no coolant
- Can be run with or without a micro peck cycle

Drilling in Metal

- These applications are run with the vacuum and coolant or mist
- Recommended to be run with a micro peck cycle

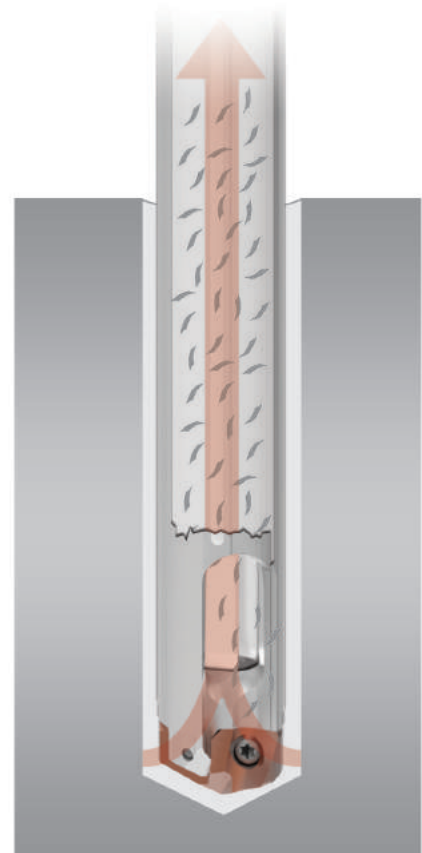

A

DRILLING

B

BORING

C

REAMING

D

BURNISHING

E

THREADING

X

SPECIALS

Engineered Specials

Featured Design | T-A® Stealth Drill

A DRILLING
B BORING
C REAMING
D BURNISHING
E THREADING
X SPECIALS



T-A Stealth Drill Highlights

- 2 adjustable Torx® PLUS screw pins allow for diameter adjustment to reduce TIR
- Provides improved tool life and hole finish
- Guided wear pads improve hole straightness
- Coolant through design with multiple coolant outlets along the drill holder provides stability in deep hole drilling applications and also improves chip evacuation



Industry Application
Automotive



Industry Application
Aerospace

Triple Coolant Outlets

- Additional coolant outlets help keep the holder straight and precise
- Longer holders experience and maintain increased stability in deeper holes

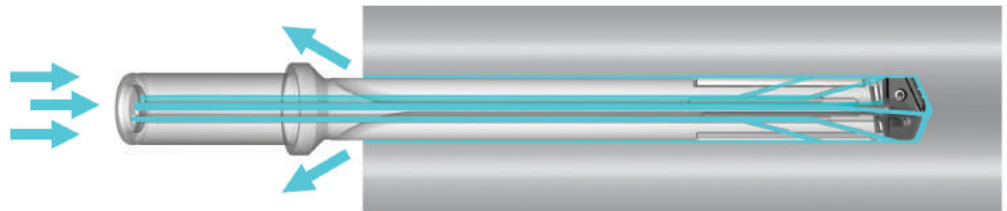

Locate the 2 adjustable Torx® PLUS screws (one on each side).

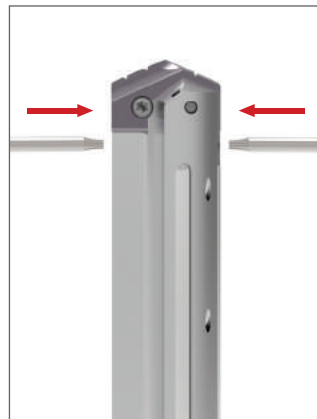

Loosen each screw.



Adjust insert position.

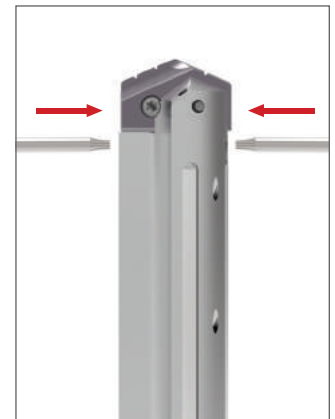

Tighten each screw.

The Proof is in the Numbers

The following results came from a real-life application that utilized the T-A Stealth Drill. The customer was experiencing a high scrap rate and needed to find a solution to eliminate the problem.

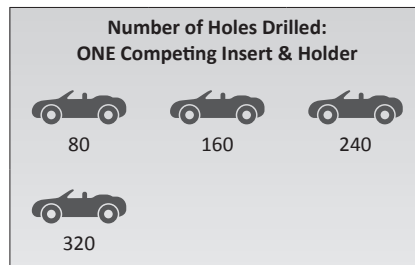

In this application, Allied Machine:

- Eliminated **\$240,000** in scrap per year
- Optimized the chip formation
- Enhanced the chip evacuation
- Provided excellent surface finish

INCREASED tool life by
280%

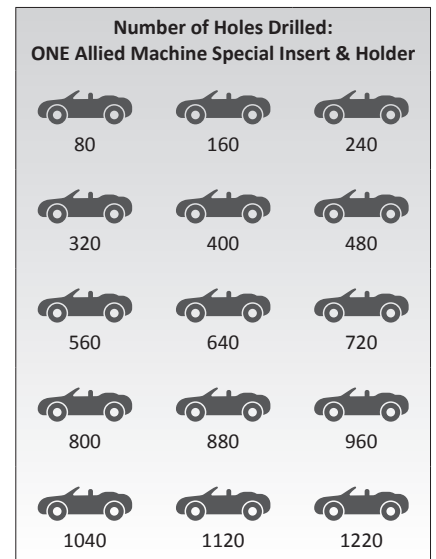

Engineered Specials

Success Stories

Real-Life Results

Below are five brief success stories. Each one provides an overview of specific situations when our special tooling achieved top-quality performance for our customers. For more success stories, or to read full in-depth case studies, go to www.alliedmachine.com/RealLifeResults.



Industry Application

Oil & Gas

Special AccuPort 432® Port Contour Cutter

Hydraulic Manifolds

- Eliminated multiple tools in the process
- Eliminated regrinds
- Improved performance in cross hole applications

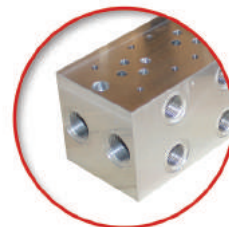

Industry Application

Heavy Equipment

Special T-A® Holder & Insert

Axle Shafts

- 100% increase in tool life
- \$7,500 reduction in set-up costs
- Eliminated scrap that was caused by set-up issues



Industry Application

Firearms

i-Form Drill

Barrel Nut

- Eliminated three tools in the process
- Reduced cycle time by 25%
- Improved chip formation



Industry Application

Automotive

T-A® Rim Drill

Aluminum Wheels

- 50% increase in penetration rates
- 50% increase in tool life
- Eliminated regrinds



Industry Application

Aerospace

Special Carbide Clad T-A® Holder with Diamond Coated Insert

Carbon Fiber Landing Arm

- Eliminated delamination of carbon fiber
- 7x more tool life
- Special shank threads directly into drill unit for easy tool change



Engineered Specials

i-Form Custom Indexable Drill / Form Tool System

Any Way You Want It

What if you could utilize complex forms that only seem to be available as brazed or solid carbide tools? Allied Machine's i-Form custom indexable drill/form tool system allows for complex designs with a replaceable cutting edge. This will reduce set-up times and eliminate regrinds, allowing you to increase your productivity and reduce costs. Don't settle for being good when the possibility of being great is right in front of you.

This is just a small sample of what you can do.



**i-Form Holder
with i-Form Inserts**



**Lug Hole T-A® Drill
with i-Form Inserts**

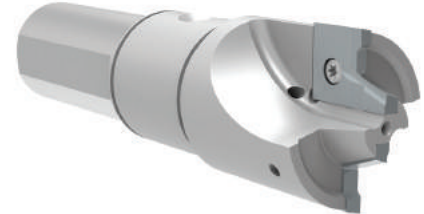

**i-Form Drill for Facing Operations
with ID-OD Chamfer**

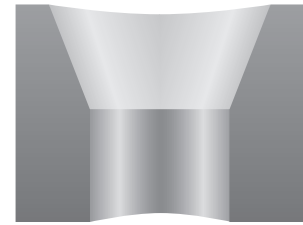
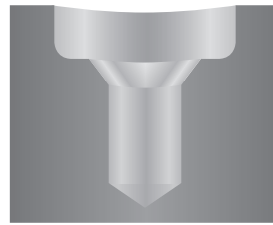
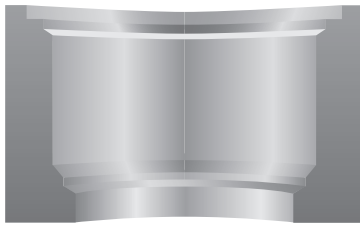

Design Complex Forms for ANY Hole Style

i-Form allows you to design complex forms for any style hole with increased productivity. The i-Form product line - both pilot inserts and form inserts - creates custom engineered forms that provide complex designs with replaceable cutting edges and improved consistency, all while outperforming brazed and solid carbide tooling. i-Form tools will increase your productivity, minimize set-up times, and eliminate regrind tool float and inconsistency.

- Holders have coolant through capabilities
- Holders can utilize standard inserts, Insta-Quote™ inserts, and/or special insert designs

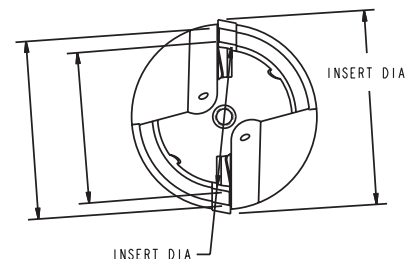
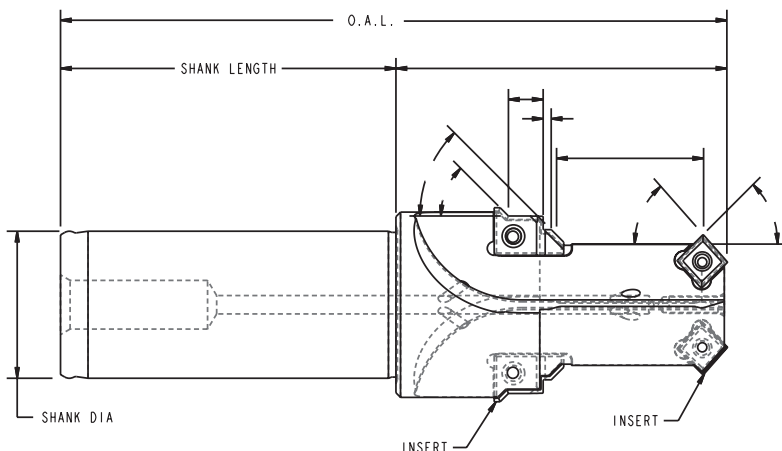

Engineered Specials

i-Form Custom Indexable Drill / Form Tool System



**GEN3SYS® XT Pilot Insert
with i-Form Inserts**



**GEN3SYS® XT Pilot Insert
with i-Form Inserts**



**GEN3SYS® XT Back Chamfer Insert
with i-Form Inserts**



**T-A® Flat Bottom Form Drill
with i-Form Inserts**



**T-A® ICS Drill
with i-Form Inserts**



**T-A® Pilot Insert
with i-Form Inserts**



**Square QDSI 34® Inserts
with i-Form Inserts**



**3 Flute IC Drill
with i-Form Inserts**



**i-Form Holder
with i-Form Inserts**

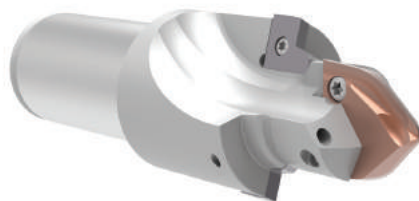

**AccuPort 432® Drill
with Special T-A® Form Insert**



**T-A 2 Step IC Drill
with i-Form Inserts**



**Special Core Drill
with i-Form Inserts**

A

DRILLING

B

BORING

C

REAMING

D

BURNISHING

E

THREADING

X

SPECIALS

Engineered Specials

Special Designs | T-A® Products

A
DRILLING
B
BORING
C
REAMING
D
BURNISHING
E
THREADING
X
SPECIALS



**T-A IC Drill
with Back Chamfer Insert**



T-A 1 Step Stub Length

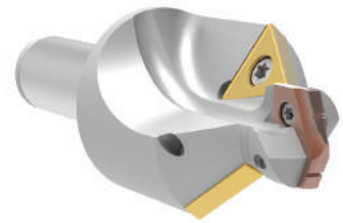

T-A IC Drill



T-A 2 Step IC Drill

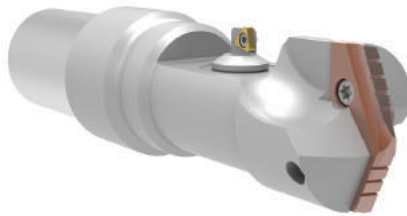

**T-A Counter Bore Tool
with Micro Adjustable Cartridge**



**T-A Form Drill
with Adjustable Cartridge**



**T-A Multiple Step Drill
with Adjustable Cartridge**

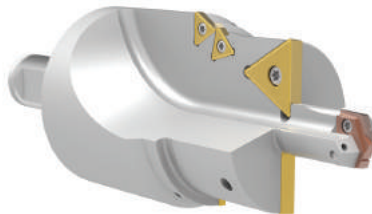

**T-A Large Diameter
Multiple Step IC Drill**



T-A Deburr Drill



**T-A IC Drill
with Customer Defined Shank**



**T-A Deep Hole Drill
with Customer Defined Design**



**T-A Chrome Bearing Drill
with Customer Defined Shank**



**T-A 1 Step IC Drill
with Flat Bottom Insert**



T-A Form Drill



**T-A Drill
with Special Holder and Insert Design**

Engineered Specials

Special Designs | Other Products



Special BT-A Drill
with Internal Thread



Special BT-A Drill



Special BT-A Drill



APX Drill
with Carbide Clad Guides



APX Drill
with 1 Step Design



APX Drill
with HSK Shank



Opening Drill®
with Special Diameter



Special Core Drill
with 2 Step Design



ICS Drill
with Adjustable Cartridge

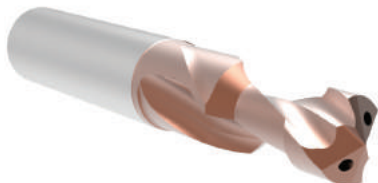

Superion™ Solid Carbide
with AM200® Coating



AccuThread™ 856
with Through Coolant



AccuPort 432®
Special Length



ALVAN® Ring Style Reamer
with Special Length



GEN3SYS® XT
with Morse Taper Shank



GEN3SYS® XT
with IC Inserts and Special Body

A

DRILLING

B

BORING

C

REAMING

D

BURNISHING

E

THREADING

X



SPECIALS

QDSI 34® Inserts

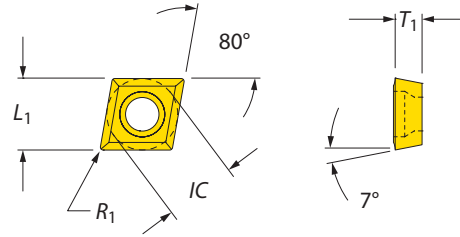
80° Diamond | 55° Diamond





80° Diamond Inserts

Imperial (inch)				Metric (mm)					ANSI Designation		
IC	L ₁	T ₁	R ₁	IC	L ₁	T ₁	R ₁				
0.250	0.249	0.094	0.008	6.35	6.32	2.39	0.20	CCGT-060202	CCGT 2(1.5)0.5	7256-IP8-1	8IP-8
0.250	0.247	0.094	0.016	6.35	6.28	2.39	0.40	CCMT-060204	CCMT 2(1.5)1	7256-IP8-1	8IP-8
0.250	0.244	0.094	0.031	6.35	6.21	2.39	0.79	CCMT-060208	CCMT 2(1.5)2	7256-IP8-1	8IP-8
0.250	0.244	0.156	0.031	6.35	6.21	3.96	0.79	CCGT-06T308	CCGT 2(2.5)2	7256-IP8-1	8IP-8
0.375	0.374	0.156	0.008	9.53	9.49	3.96	0.20	CCGT-09T302	CCGT 3(2.5)0.5	7359-IP15-1	8IP-15
0.375	0.372	0.156	0.016	9.53	9.46	3.96	0.40	CCMT-09T304	CCMT 3(2.5)1	7359-IP15-1	8IP-15
0.375	0.369	0.156	0.031	9.53	9.39	3.96	0.79	CCMT-09T308	CCMT 3(2.5)2	7359-IP15-1	8IP-15
0.500	0.497	0.188	0.016	12.70	12.63	4.76	0.40	CCMT-120404	CCMT 431	745105-IP20-1	8IP-20
0.500	0.494	0.188	0.031	12.70	12.56	4.76	0.79	CCMT-120408	CCMT 432	745105-IP20-1	8IP-20

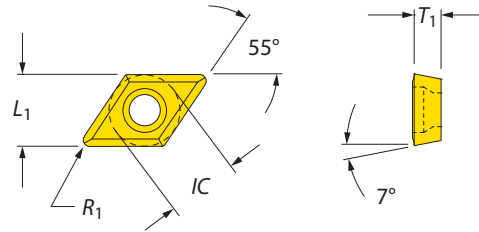
NOTE: QDSI 34 inserts are utilized only in special ICS holders. Speeds and feeds for QDSI 34 inserts are determined by drill insert.



55° Diamond Inserts

Imperial (inch)				Metric (mm)					ANSI Designation		
IC	L ₁	T ₁	R ₁	IC	L ₁	T ₁	R ₁				
0.250	0.243	0.094	0.008	6.35	6.18	2.39	0.008	DCGT-070202	DCGT 2(1.5)0.5	7256-IP8-1	8IP-8
0.250	0.237	0.094	0.016	6.35	6.01	2.39	0.016	DCMT-070204	DCMT 2(1.5)1	7256-IP8-1	8IP-8
0.250	0.223	0.094	0.031	6.35	5.67	2.39	0.031	DCMT-070208	DCMT 2(1.5)2	7256-IP8-1	8IP-8
0.375	0.362	0.156	0.016	9.53	9.19	3.96	0.016	DCMT-11T304	DCMT 3(2.5)1	7359-IP15-1	8IP-15
0.375	0.348	0.156	0.031	9.53	8.85	3.96	0.031	DCMT-11T308	DCMT 3(2.5)2	7359-IP15-1	8IP-15



NOTE: QDSI 34 inserts are utilized only in special ICS holders. Speeds and feeds for QDSI 34 inserts are determined by drill insert.

QDSI 34® Inserts

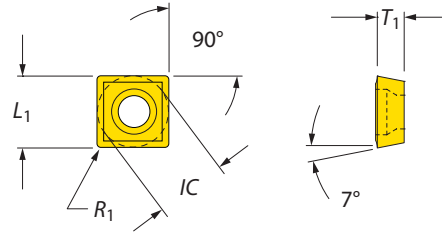
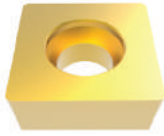
Square | 60° Triangle





Square Inserts

Imperial (inch)				Metric (mm)					ANSI Designation		
IC	L ₁	T ₁	R ₁	IC	L ₁	T ₁	R ₁	Part No.		Torx Screw	Torx Driver
0.375	0.375	0.156	0.016	9.53	9.53	3.96	0.40	SCMT-09T304	SCMT 3(2.5)1	7359-IP15-1	8IP-15

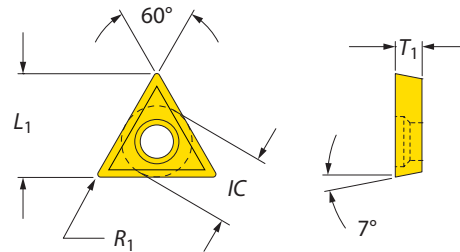
NOTE: QDSI 34 inserts are utilized only in special ICS holders. Speeds and feeds for QDSI 34 inserts are determined by drill insert.



60° Triangle Inserts

Imperial (inch)				Metric (mm)					ANSI Designation		
IC	L ₁	T ₁	R ₁	IC	L ₁	T ₁	R ₁	Part No.		Torx Screw	Torx Driver
0.156	0.259	0.078	0.008	3.97	6.58	1.98	0.20	TCGT-06T102	TCGT 1.2(1.2)0.5	724-IP6-1	8IP-6
0.156	0.248	0.078	0.016	3.97	6.29	1.98	0.40	TCGT-06T104	TCGT 1.2(1.2)1	724-IP6-1	8IP-6
0.156	0.225	0.078	0.031	3.97	5.71	1.98	0.79	TCGT-06T108	TCGT 1.2(1.2)2	724-IP6-1	8IP-6
0.219	0.367	0.094	0.008	5.65	9.33	2.39	0.20	TCGT-090202	TCGT 1.8(1.5)0.5	7225-IP7-1	8IP-7
0.219	0.356	0.094	0.016	5.65	9.04	2.39	0.40	TCGT-090204	TCGT 1.8(1.5)1	7225-IP7-1	8IP-7
0.219	0.333	0.094	0.031	5.65	8.46	2.39	0.79	TCGT-090208	TCGT 1.8(1.5)2	7225-IP7-1	8IP-7
0.250	0.422	0.094	0.008	6.35	10.71	2.39	0.20	TCGT-110202	TCGT 2(1.5)0.5	7256-IP8-1	8IP-8
0.250	0.410	0.094	0.016	6.35	10.42	2.39	0.40	TCMT-110204	TCMT 2(1.5)1	7256-IP8-1	8IP-8
0.250	0.387	0.094	0.031	6.35	9.84	2.39	0.79	TCMT-110208	TCMT 2(1.5)2	7256-IP8-1	8IP-8
0.375	0.627	0.156	0.016	9.53	15.92	3.96	0.40	TCMT-16T304	TCMT 3(2.5)1	7359-IP15-1	8IP-15
0.375	0.604	0.156	0.031	9.53	15.34	3.96	0.79	TCMT-16T308	TCMT 3(2.5)2	7359-IP15-1	8IP-15
0.500	0.820	0.188	0.031	12.70	20.83	4.76	0.79	TCGT-220408	TCGT 432	745105-IP20-1	8IP-20

NOTE: QDSI 34 inserts are utilized only in special ICS holders. Speeds and feeds for QDSI 34 inserts are determined by drill insert.

A DRILLING
B BORING
C REAMING
D BURNISHING
E THREADING
X SPECIALS

Special Tooling

Complete Your Design

Show Us What You Need

These pages have been included so you can assist us with defining your special tooling requirements.

- Select a Shank (1 - 6), or define Shank 7
- Indicate if the shank will be used with or without a Rotary Coolant Adapter (RCA)

We ask that you define your hole profile and offer an example of a tool form to help us with the design process. Tools 1 - 5 cover only a small portion of our capabilities, so feel free to use your imagination. Please scan these pages, record your information in the boxes on the next page, and email the information for our quickest response.

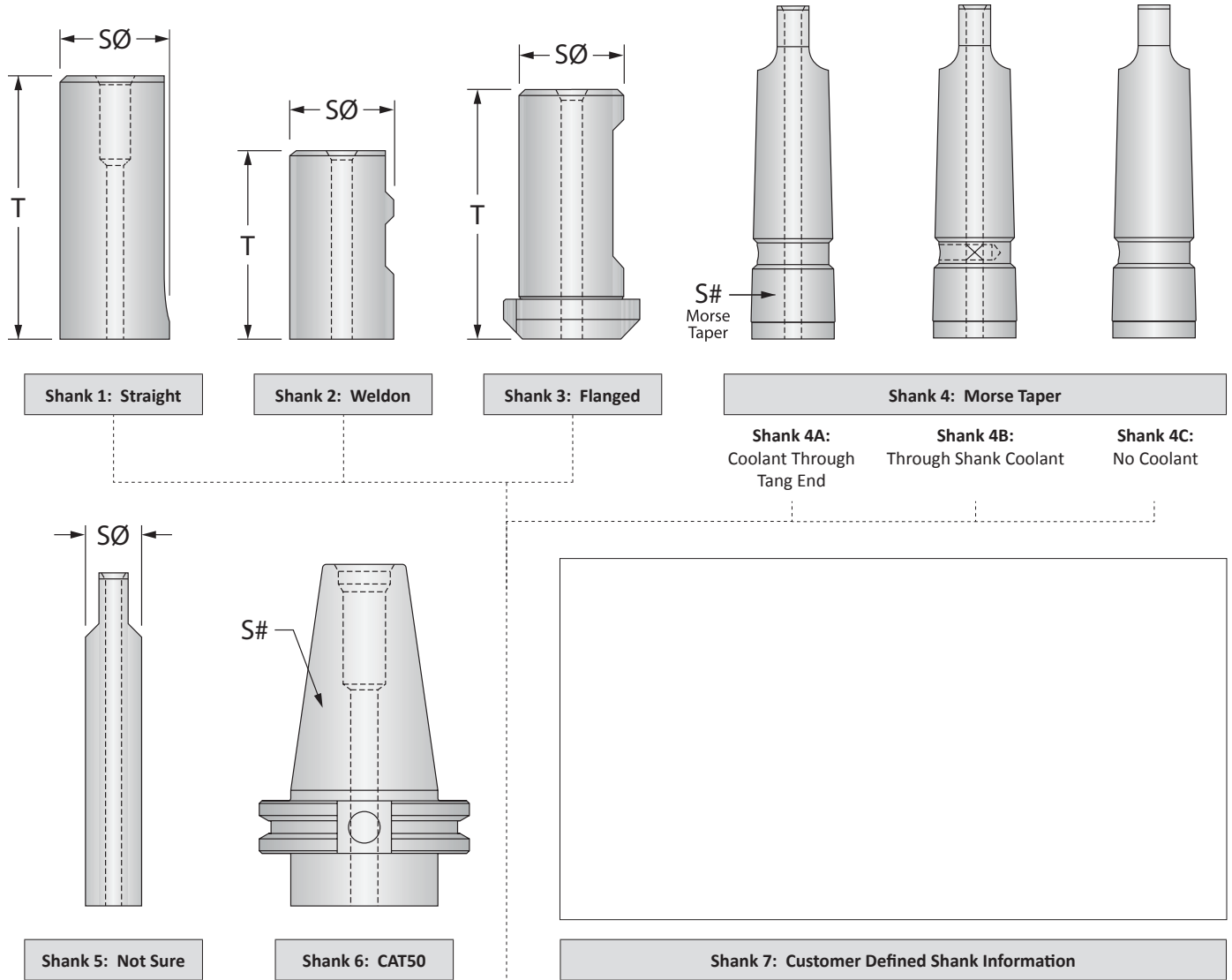

Shank	$S\varnothing$	$S\#$	T	RCA
4A (EXAMPLE)	-	4MT	-	YES <input checked="" type="radio"/> NO
				YES / NO
				YES / NO
				YES / NO

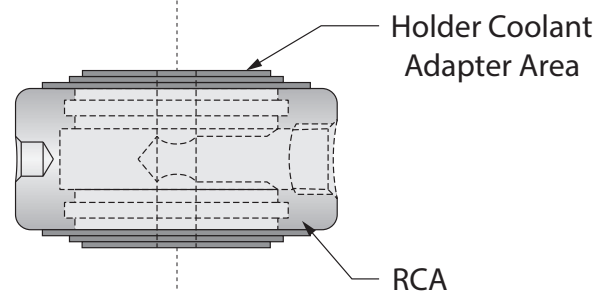

Tool 1

- Carbide Clad
- Chrome Plate
- Helical Flute
- Straight Flute

Tool 2

- Helical Pilot
- Chrome Pilot

Tool 3

- Helical Flute
- Straight Flute

Tool 4

- Helical Pilot
- Chrome Pilot

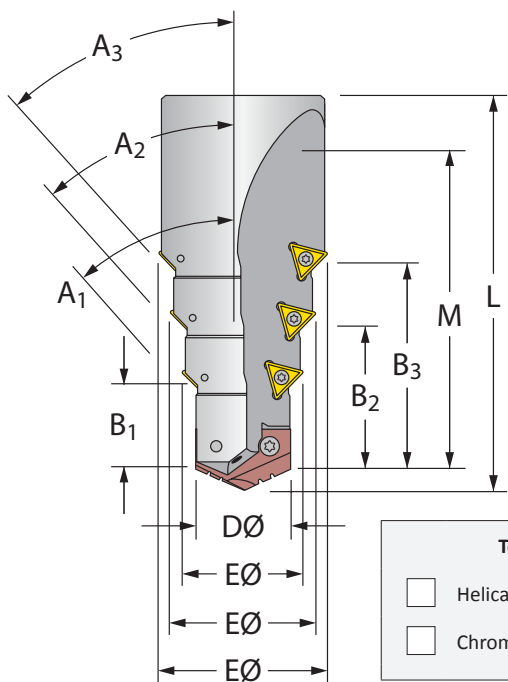
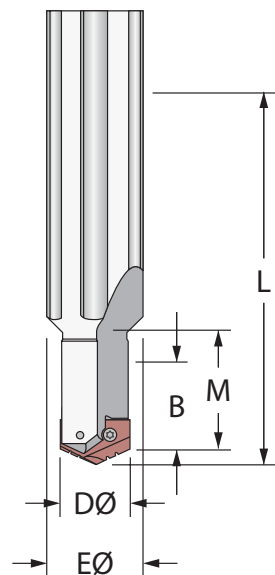
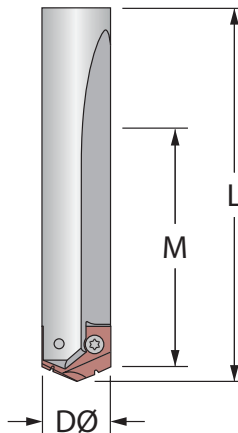
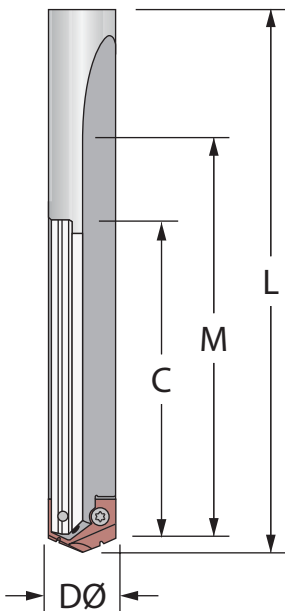
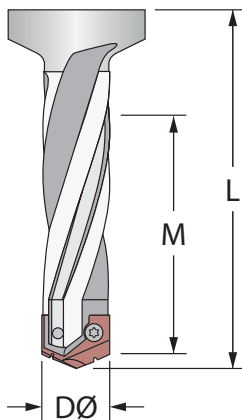

Tool 5

- Helical Pilot
- Chrome Pilot

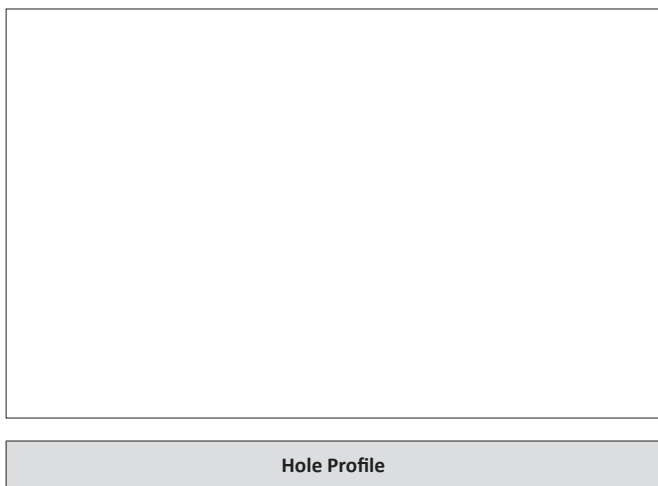

Please email or fax your design to:
 Application Engineering Department
 P: 800.321.5537
 F: 330.343.7666
 E: aesupport@alliedmachine.com

Item	Tool	A ₁	A ₂	A ₃	B ₁	B ₂	B ₃	C	D Ø	E Ø	F Ø	G	L	M
EXAMPLE	5	30°	-	-	1.00	-	-	0.25	0.620	1.25	-	-	4.50	3.00

Customer Signature: _____ Date: _____

Please be sure to include shank and coolant information from the previous page when sending tool designs

A DRILLING
 B BORING
 C REAMING
 D BURNISHING
 E THREADING
 X SPECIALS

Deep Hole Drilling Guidelines

For Lengths Greater Than 9xD (including Extended, Long, XL, 3XL, and Special Length)

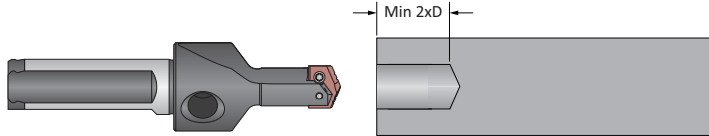
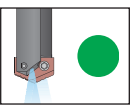
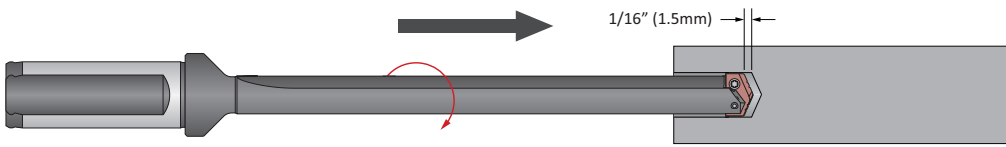
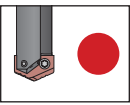
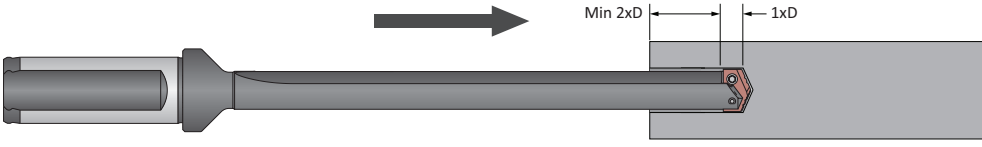
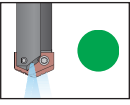
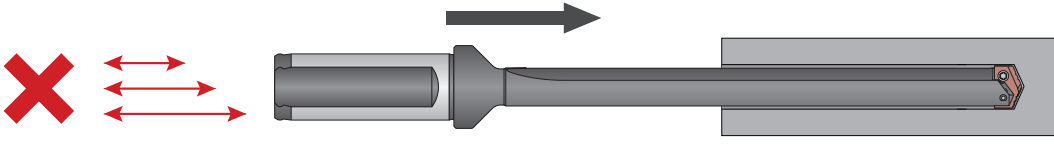
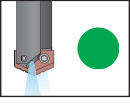
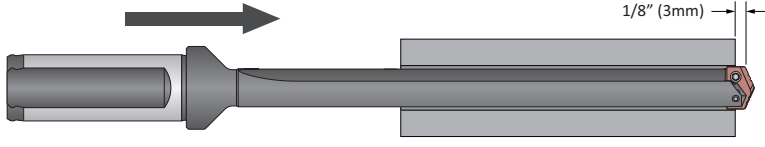
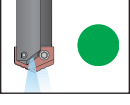
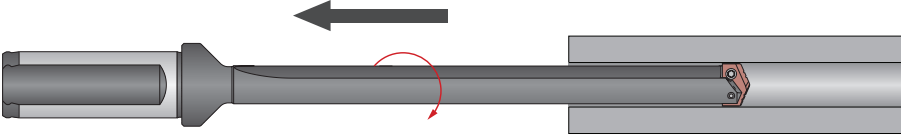
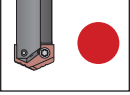
A DRILLING	<p>1. Pilot Hole 100 % RPM 100% IPR (mm/rev)</p> <p>Establish the pilot hole using the same diameter short drill to a depth of 2xD minimum. Utilize a pilot drill with the same or larger included point angle.</p>  <p>Coolant ON</p> 
B BORING	<p>2. Feed-in 50 RPM max 12 IPM (300 mm/min)</p> <p>Feed the longer drill within 1/16" (1.5mm) short of the established pilot hole bottom at a maximum of 50 RPM and 12 IPM (300 mm/min) feed rate.</p>  <p>Coolant OFF</p> 
C REAMING	<p>3. Deep Hole Transition Drilling 50 % RPM 75% IPR (mm/rev)</p> <p>Drill additional 1xD past the bottom of the pilot hole at 50% reduction of recommended speed and 25% reduction of recommended feed. Minimum of 1 second dwell is required to meet full speed before feeding.</p>  <p>Coolant ON</p> 
D BURNISHING	<p>4. Deep Hole Drilling - Blind 100% RPM 100% IPR (mm/rev)</p> <p>Drill to full depth at recommended speed and feed for longer drill according to Allied speed and feed charts. No peck cycle recommended.</p>  <p>Coolant ON</p> 
E THREADING	<p>5. Deep Hole Drilling - at Breakout 50% RPM 75% IPR (mm/rev)</p> <p>For through holes only: Reduce speed by 50% and feed by 25% prior to breakout. Do not breakout more than 1/8" (3mm) past the full diameter of the drill.</p>  <p>Coolant ON</p> 
X SPECIALS	<p>6. Drill Retract 50 RPM max</p> <p>Reduce speed to a maximum of 50 RPM before retracting from the hole.</p>  <p>Coolant OFF</p> 

1. WARNING Tool failure can cause serious injury. To prevent:

- When using holders without support bushing, use a short holder to establish an initial hole that is a minimum of 2 diameters deep.
- Do not rotate tool holders more than 50 RPM unless it is engaged with the workpiece or fixture.

Visit www.alliedmachine.com/DeepHoleGuidelines for the most up-to-date information and procedures. Factory technical assistance is available for your specific applications through our Application Engineering Team.

Part No.	Page
0	
02B.40...	C: 56
02B.45...	C: 56
02B.50...	C: 56
1	
10214...	A40: 7
10215...	A40: 7
1021A...	A40: 6
1021N...	A40: 6
1021T...	A40: 6
1022A...	A40: 11
1022A...	A40: 10
1022N...	A40: 10
1022T...	A40: 10
10234...	A40: 15
10235...	A40: 15
1023A...	A40: 14
1023N...	A40: 14
1023T...	A40: 14
10244...	A40: 19
10245...	A40: 19
1024A...	A40: 18
1024N...	A40: 18
1024T...	A40: 18
1024U...	A40: 18, A40: 38
1025A...	A40: 23
10255...	A40: 23
1025A...	A40: 22
1025N...	A40: 22
1025T...	A40: 22
1025U...	A40: 22, A40: 38
10264...	A40: 27
10265...	A40: 27
1026A...	A40: 26
1026N...	A40: 26
1026T...	A40: 26
1026U...	A40: 26, A40: 38
1027A...	A40: 31
10275...	A40: 31
1027A...	A40: 30
1027N...	A40: 30
1027T...	A40: 30
1027U...	A40: 30, A40: 38
1028A...	A40: 35
10285...	A40: 35
1028A...	A40: 34
1028N...	A40: 34
1028T...	A40: 34
1028U...	A40: 34, A40: 38
1029A...	A40: 36
1041A...	A40: 7
1042A...	A40: 11
1043A...	A40: 15
1044A...	A40: 19
1045A...	A40: 23
1046A...	A40: 27
1047A...	A40: 31
1048A...	A40: 35
1121A...	A40: 7
1122A...	A40: 11
1123A...	A40: 15
1124A...	A40: 19
1125A...	A40: 23

Part No.	Page
11264...	A40: 27
131...	A30: 48, A30: 49
132...	A30: 63, A30: 64
135...	A30: 95
136...	A30: 97
137...	A30: 103
138...	A30: 105
150...	A30: 34, A30: 35, A91: 20, A92: 21, A92: 23, A92: 25, A92: 27
151...	A30: 46, A30: 47, A30: 48, A91: 24, A92: 21, A92: 23, A92: 25, A92: 27
152...	A30: 60, A30: 61, A30: 62, A30: 63, A91: 28, A92: 21, A92: 23, A92: 25, A92: 27
153...	A30: 77, A30: 78, A30: 79, A91: 32
154...	A30: 88, A30: 89
155...	A30: 95
156...	A30: 97
157...	A30: 103
158...	A30: 105
15Y...	A30: 14, A30: 15, A92: 21, A92: 23, A92: 25, A92: 27
15Z...	A30: 24, A30: 25, A92: 21, A92: 23, A92: 25, A92: 27
180...	A30: 33
181...	A30: 45
182...	A30: 59
18Y...	A30: 13
18Z...	A30: 23
1C20...	A30: 36
1C21...	A30: 50
1C22...	A30: 65, A30: 66
1C23...	A30: 80
1C2Y...	A30: 16
1C2Z...	A30: 26
1C30...	A30: 37
1C31...	A30: 51
1C32...	A30: 67
1C3Y...	A30: 17
1C3Z...	A30: 27
1C50...	A30: 37
1C51...	A30: 51
1C52...	A30: 67
1C53...	A30: 81, A92: 7, A92: 9, A92: 11, A92: 13, A92: 15
1C5Y...	A30: 17
1C5Z...	A30: 27
1N20...	A30: 37
1N21...	A30: 51
1N22...	A30: 67
1N2Y...	A30: 17
1N2Z...	A30: 27
2	

Part No.	Page
20231...	A40: 16
20241...	A40: 20
20251...	A40: 24
20261...	A40: 28
20411...	A40: 8
20421...	A40: 12
20431...	A40: 16
20441...	A40: 20
20451...	A40: 24
20461...	A40: 28
20611...	A40: 8
20621...	A40: 12
20631...	A40: 16
20641...	A40: 20
20651...	A40: 24
20661...	A40: 28
20671...	A40: 32
20681...	A40: 37
20811...	A40: 8
20821...	A40: 12
20831...	A40: 16
20841...	A40: 20
20851...	A40: 24
20861...	A40: 28
20871...	A40: 32
20881...	A40: 37
21000...	A30: 38, A30: 42
21005...	A30: 38
21010...	A30: 52
21011...	A40: 8
21015...	A30: 52
21020...	A30: 68
21021...	A40: 12
21025...	A30: 68
21030...	A30: 82
21031...	A40: 16
21041...	A40: 20
21051...	A40: 24
21061...	A40: 28
210Y0...	A30: 18, A30: 21
210Z0...	A30: 28, A30: 31
21411...	A40: 9
21421...	A40: 12
21431...	A40: 16
21441...	A40: 20
21451...	A40: 24
21461...	A40: 28
21471...	A40: 32
21481...	A40: 37
21511...	A40: 9
21521...	A40: 12
21531...	A40: 16
21541...	A40: 20
21551...	A40: 24
21561...	A40: 28
21571...	A40: 32
21611...	A40: 9
21621...	A40: 12
21631...	A40: 16
21641...	A40: 20
21651...	A40: 24
21661...	A40: 28
21671...	A40: 32

Part No.	Page
21681...	A40: 37
21811...	A40: 9
21821...	A40: 12
21831...	A40: 16
21841...	A40: 20
21851...	A40: 24
21861...	A40: 28
21871...	A40: 32
21881...	A40: 37
22000...	A30: 38, A30: 40, A30: 42, A91: 22
22005...	A30: 38, A30: 40, A30: 42, A91: 22
22010...	A30: 52, A30: 54, A30: 56, A91: 26
22011...	A40: 9
22015...	A30: 52, A30: 54, A30: 56, A91: 26
22020...	A30: 68, A30: 70, A30: 72, A91: 30
22025...	A30: 68, A30: 70, A30: 72
22021...	A40: 12
22025...	A91: 30
22030...	A30: 82, A30: 84, A30: 85, A91: 34
22031...	A40: 16
22040...	A30: 90, A30: 91, A30: 92
22041...	A40: 20
22050...	A30: 98, A30: 99, A30: 100
22051...	A40: 24
22061...	A40: 28
22070...	A30: 106, A30: 107, A30: 108
22071...	A40: 32
22081...	A40: 37
220Y0...	A30: 18, A30: 20, A30: 21
220Z0...	A30: 28, A30: 30, A30: 31
22211...	A40: 9
22221...	A40: 12
22231...	A40: 16
22241...	A40: 20
22261...	A40: 28
22271...	A40: 32
22281...	A40: 37
22421...	A40: 13
22431...	A40: 17
22461...	A40: 29
22471...	A40: 33
22621...	A40: 13
22631...	A40: 17
22641...	A40: 21
22651...	A40: 25
22661...	A40: 29
22671...	A40: 33
22821...	A40: 13
22831...	A40: 17
22841...	A40: 21
22851...	A40: 25

Part No.	Page
22861...	A40: 29
22881...	A40: 33
23010...	A30: 52, A30: 53, A30: 54, A30: 55, A30: 56
23015...	A30: 52, A30: 53, A30: 54, A30: 55, A30: 56
23020...	A30: 68, A30: 69, A30: 70, A30: 71, A30: 72
23025...	A30: 68, A30: 69, A30: 70, A30: 71, A30: 72
23030...	A30: 82, A30: 83, A30: 84, A30: 85
24000...	A30: 38, A30: 39, A30: 40, A30: 41, A30: 42, A91: 23
24005...	A30: 38, A30: 39, A30: 40, A30: 41, A30: 42, A91: 23
24010...	A30: 52, A30: 53, A30: 54, A30: 55, A30: 56, A91: 27
24015...	A30: 52, A30: 53, A30: 54, A30: 55, A30: 56, A91: 27
24020...	A30: 68, A30: 69, A30: 70, A30: 71, A30: 72, A91: 31
24025...	A30: 68, A30: 69, A30: 70, A30: 71, A30: 72, A91: 31
24030...	A30: 82, A30: 83, A30: 84, A30: 85, A91: 34
24040...	A30: 90, A30: 91, A30: 92
24050...	A30: 98, A30: 99, A30: 100
24070...	A30: 106, A30: 107, A30: 108
240Y0...	A30: 18, A30: 19, A30: 20, A30: 21
240Z0...	A30: 28, A30: 29, A30: 30, A30: 31
2430...	C: 26
2431...	C: 27
2440...	C: 22
2441...	C: 23
24410...	A40: 41
24420...	A40: 41
24430...	A40: 41
24440...	A40: 41
24450...	A40: 41
24460...	A40: 41
24470...	A40: 41
24480...	A40: 41
24500...	A30: 39
24510...	A30: 53
24520...	A30: 69
245Y0...	A30: 19

Part No.	Page
24520...	A30: 29
25000...	A30: 38, A30: 39, A30: 40, A30: 41, A30: 42, A91: 23
25005...	A30: 38, A30: 39, A30: 40, A30: 41, A30: 42, A91: 23
25010...	A30: 52, A30: 53, A30: 54, A30: 55, A30: 56, A91: 27
25015...	A30: 52, A30: 53, A30: 54, A30: 55, A30: 56, A91: 27
25020...	A30: 68, A30: 69, A30: 70, A30: 71, A30: 72, A91: 31
25025...	A30: 68, A30: 69, A30: 70, A30: 71, A30: 72
25030...	A30: 82, A30: 84, A30: 85
25040...	A30: 90, A30: 91, A30: 92
25050...	A30: 98, A30: 99, A30: 100
25070...	A30: 106, A30: 107, A30: 108
250Y0...	A30: 18, A30: 19, A30: 20, A30: 21
250Z0...	A30: 28, A30: 29, A30: 30, A30: 31
26000...	A30: 39, A30: 41, A30: 42
26005...	A30: 39, A30: 41, A30: 42
26010...	A30: 53, A91: 27
26015...	A91: 27
26020...	A30: 69, A91: 31
260Z0...	A30: 29
26500...	A30: 39
27000...	A30: 38, A30: 42
27010...	A30: 52, A30: 56
27020...	A30: 68, A30: 72
27030...	A30: 82, A30: 84, A30: 85
27040...	A30: 90, A30: 91, A30: 92
27050...	A30: 99, A30: 100
27070...	A30: 107, A30: 108
270Y0...	A30: 18, A30: 21
270Z0...	A30: 28, A30: 31
29000...	A30: 38, A30: 42
29010...	A30: 52, A30: 56
29020...	A30: 68, A30: 72
29030...	A30: 82, A30: 84, A30: 85
29040...	A30: 90, A30: 91, A30: 92
29050...	A30: 99, A30: 100
29070...	A30: 107, A30: 108
290Y0...	A30: 18, A30: 21
290Z0...	A30: 28, A30: 31
2T-2SR...	A30: 21, A30: 31,

Part No.	Page
	A30: 43, A30: 110
2T-3SR...	A30: 57, A30: 73, A30: 110
2T-4SR...	A30: 73, A30: 85, A30: 93, A30: 110, A40: 9, A40: 13, A40: 17, A40: 21, A40: 40
2T-5SR...	A30: 85, A30: 93, A30: 110, A40: 13, A40: 17, A40: 21, A40: 40
2T-55SR...	A40: 21, A40: 25, A40: 37, A40: 40
2T-6SR...	A30: 101, A30: 109, A30: 110, A40: 25, A40: 29, A40: 33, A40: 37, A40: 40
2T-60SR...	A40: 29, A40: 40
2T-65SR...	A40: 33, A40: 40
3	
30.50R...	C: 60
30.63R...	C: 60
30.80R...	C: 60
335...	A10: 4, A10: 5
35.50R...	C: 61
35.63R...	C: 61
360...	A10: 6, A10: 7, A10: 8, A10: 9
3610...	C: 28
3617...	C: 29
3620...	C: 24
3627...	C: 25
390...	A10: 10, A10: 11
4	
40.50R...	C: 61
40.63R...	C: 61
4300...	C: 50, C: 51
4305...	C: 52, C: 53
4330...	C: 42, C: 43
4335...	C: 44, C: 45
434...	A30: 87
435...	A30: 94
4350...	C: 46, C: 47
4355...	C: 48, C: 49
436...	A30: 96
437...	A30: 102
450...	A30: 32, A91: 21, A92: 7, A92: 9, A92: 11, A92: 13, A92: 15, A92: 17, A92: 18, A92: 19, A92: 20, A92: 22, A92: 24, A92: 26, A92: 28
4500...	C: 38, C: 39
4505...	C: 40, C: 41
451...	A30: 44, A91: 25, A92: 7, A92: 9, A92: 11, A92: 13, A92: 15, A92: 17, A92: 18, A92: 19,

Part No.	Page
	A92: 20, A92: 22, A92: 24, A92: 26, A92: 28
452...	A30: 58, A91: 29, A92: 7, A92: 9, A92: 11, A92: 13, A92: 15, A92: 17, A92: 18, A92: 19, A92: 20, A92: 22, A92: 24, A92: 26, A92: 28
453...	A30: 75, A91: 33, A92: 7, A92: 9, A92: 11, A92: 13, A92: 15, A92: 17, A92: 18, A92: 19, A92: 20, A92: 21, A92: 22, A92: 23, A92: 24, A92: 25, A92: 26, A92: 27, A92: 28
454...	A30: 86, A92: 7, A92: 9, A92: 11, A92: 13, A92: 15, A92: 17, A92: 18, A92: 19, A92: 20, A92: 21, A92: 22, A92: 23, A92: 24, A92: 25, A92: 26, A92: 27, A92: 28
455...	A30: 94
4550...	C: 34, C: 35
4555...	C: 36, C: 37
456...	A30: 96
457...	A30: 102
458...	A30: 104
45Y...	A30: 12, A92: 7, A92: 9, A92: 11, A92: 13, A92: 15, A92: 17, A92: 18, A92: 19, A92: 20, A92: 22, A92: 24, A92: 26, A92: 28
45Z...	A30: 22, A92: 7, A92: 9, A92: 11, A92: 13, A92: 15, A92: 17, A92: 18, A92: 19, A92: 20, A92: 22, A92: 24, A92: 26, A92: 28
483...	A30: 74, A30: 76
4C10...	A30: 32, A91: 21, A92: 7, A92: 9, A92: 11, A92: 13, A92: 15
4C11...	A30: 44, A91: 25, A92: 7, A92: 9, A92: 11, A92: 13, A92: 15
4C12...	A30: 58, A91: 29, A92: 7, A92: 9, A92: 11, A92: 13, A92: 15

Part No.	Page
4C1Y...	A30: 12, A92: 7, A92: 9, A92: 11, A92: 13, A92: 15
4C1Z...	A30: 22, A92: 7, A92: 9, A92: 11, A92: 15
4C20...	A30: 32, A92: 17
4C21...	A30: 44, A92: 17
4C22...	A30: 58, A92: 17
4C2Y...	A30: 12, A92: 17
4C2Z...	A30: 22, A92: 17
6	
60111C45...	A20: 15
60111H...	A20: 15
60112C45...	A20: 19
60112H...	A20: 19
60113C45...	A20: 23
60113H...	A20: 23
60114C45...	A20: 27
60114H...	A20: 27
60115C45...	A20: 31
60115H...	A20: 31
60116C45...	A20: 35
60116H...	A20: 35
60117C45...	A20: 39
60117H...	A20: 39
60118C45...	A20: 43
60118H...	A20: 43
60120C45...	A20: 47
60120H...	A20: 47
60122C45...	A20: 51
60122H...	A20: 51
60124C45...	A20: 55
60124H...	A20: 55
60126C45...	A20: 59
60126H...	A20: 59
60129C45...	A20: 63
60129H...	A20: 63
60132C45...	A20: 67
60132H...	A20: 67
60311H...	A20: 15
60311S...	A20: 15
60312H...	A20: 19
60312S...	A20: 19
60313H...	A20: 23
60313S...	A20: 23
60314H...	A20: 27
60314S...	A20: 27
60315H...	A20: 31
60315S...	A20: 31
60316H...	A20: 35
60316S...	A20: 35
60317H...	A20: 39
60317S...	A20: 39
60318H...	A20: 43
60318S...	A20: 43
60320H...	A20: 47
60320S...	A20: 47
60322H...	A20: 51
60322S...	A20: 51
60324H...	A20: 55
60324S...	A20: 55
60326H...	A20: 59

Part No.	Page
60326S...	A20: 59
60329H...	A20: 63
60329S...	A20: 63
60332H...	A20: 67
60332S...	A20: 67
60511H...	A20: 15
60511S...	A20: 15
60512H...	A20: 19
60512S...	A20: 19
60513H...	A20: 23
60513S...	A20: 23
60514H...	A20: 27
60514S...	A20: 27
60515H...	A20: 31
60515S...	A20: 31
60516H...	A20: 35
60516S...	A20: 35
60517H...	A20: 39
60517S...	A20: 39
60518H...	A20: 43
60518S...	A20: 43
60520H...	A20: 47
60520S...	A20: 47
60522H...	A20: 51
60522S...	A20: 51
60524H...	A20: 55
60524S...	A20: 55
60526H...	A20: 59
60526S...	A20: 59
60529H...	A20: 63
60529S...	A20: 63
60532H...	A20: 67
60532S...	A20: 67
60711H...	A20: 15
60711S...	A20: 15
60712H...	A20: 19
60712S...	A20: 19
60713H...	A20: 23
60713S...	A20: 23
60714H...	A20: 27
60714S...	A20: 27
60715H...	A20: 31
60715S...	A20: 31
60716H...	A20: 35
60716S...	A20: 35
60717H...	A20: 39
60717S...	A20: 39
60718H...	A20: 43
60718S...	A20: 43
60720H...	A20: 47
60720S...	A20: 47
60722H...	A20: 51
60722S...	A20: 51
60724H...	A20: 55
60724S...	A20: 55
60726H...	A20: 59
60726S...	A20: 59
60729H...	A20: 63
60729S...	A20: 63
60732H...	A20: 67
60732S...	A20: 67
7	
7000...	C: 12

Part No.	Page
7000-MC...	C: 16
7000-ML...	C: 17
7000-MM...	C: 18
7000-VI...	C: 14, C: 15
7001-MC...	C: 16
7001-ML...	C: 17
7001-MM...	C: 18
7001-VI...	C: 14, C: 15
7400...	C: 12
7405...	C: 13
7705...	C: 13
7C111P...	A20: 14
7C112P...	A20: 18
7C113P...	A20: 22
7C114P...	A20: 26
7C115P...	A20: 30
7C116P...	A20: 34
7C117P...	A20: 38
7C118P...	A20: 42
7C120P...	A20: 46
7C122P...	A20: 50
7C124P...	A20: 54
7C126P...	A20: 58
7C129P...	A20: 62
7C132P...	A20: 66
7C211P...	A20: 14
7C212P...	A20: 18, A91: 8
7C213P...	A20: 22
7C214P...	A20: 26, A91: 9
7C215P...	A20: 30, A91: 10
7C216P...	A91: 11
7C217P...	A20: 38, A91: 12
7C218P...	A20: 42, A91: 13
7C220P...	A20: 46, A91: 14
7C222P...	A20: 50, A91: 15
7C224P...	A20: 54, A91: 16
7C226P...	A91: 17
7C229P...	A20: 62, A91: 18
7C232P...	A20: 66, A91: 19
9	
94500...	C: 38, C: 39
94505...	C: 40, C: 41
94550...	C: 34, C: 35
94555...	C: 36, C: 37
A	
AS5202...	A92: 14, A92: 15, A92: 26, A92: 27
ATKK...	A92: 18, A92: 20, A92: 22, A92: 24, A92: 26, A92: 28
ATKU...	A92: 19, A92: 21, A92: 23, A92: 25, A92: 27
B	
BFB-075...	B20: 21
BFC-076...	B20: 20
BFC-300...	B20: 20, B20: 21
BTA0...	A93: 4
BTA1...	A93: 5
BTA2...	A93: 6
BTA3...	A93: 7
BTAT...	A93: 4, A93: 5, A93: 6, A93: 7

Part No.	Page
BTB.40...	C: 57
BTB.50...	C: 57
BTH-0125...	B20: 25, B20: 48, B20: 68
BTH-0187...	B20: 25, B20: 57
BTH-0250...	B20: 25, B20: 49, B20: 57, B20: 69
BTH-0312...	B20: 57
BTH-0375...	B20: 25, B20: 54, B20: 57, B20: 58
BTH-0500...	B20: 25, B20: 53, B20: 54, B20: 56, B20: 57, B20: 58, B20: 69, B20: 72, B20: 73
BTH-0625...	B20: 25, B20: 57, B20: 58
BTH-0750...	B20: 25, B20: 54, B20: 56, B20: 57,
BTH-10...	B20: 55
BTH-1000...	B20: 25, B20: 56
BTH-10M...	B20: 25
BTH-12...	B20: 55
BTH-12M...	B20: 25
BTH-20...	B20: 55
BTH-20M...	B20: 25
C	
C34...	A60: 7
C36...	A60: 9
C38...	A60: 11
C42...	A60: 13
C44...	A60: 14
C46...	A60: 15
C48...	A60: 16
C52...	A60: 17
C54...	A60: 18
C56...	A60: 19
C58...	A60: 20
CB025M...	B20: 10, B20: 11, B20: 12, B20: 13
CB032M...	B20: 10, B20: 11, B20: 12, B20: 13
CB-038...	B20: 16, B20: 17, B20: 73
CB038...	B20: 43
CB038M...	B20: 10, B20: 11, B20: 12, B20: 13, B20: 14, B20: 17
CB-050...	B20: 16, B20: 17, B20: 70, B20: 72, B20: 73
CB050...	B20: 43, B20: 70
CB050M...	B20: 10, B20: 12, B20: 13, B20: 17
CB062...	B20: 39
CB0625...	B20: 27, B20: 29, B20: 37
CB-064...	B20: 16, B20: 17
CB0750...	B20: 27, B20: 29, B20: 37, B20: 39
CB-076...	B20: 16, B20: 17, B20: 72, B20: 73

Part No.	Page
CB076...	B20: 43
CB076M...	B20: 10, B20: 11, B20: 12, B20: 13, B20: 17
CB1000...	B20: 10, B20: 11, B20: 12, B20: 13, B20: 24, B20: 27, B20: 29, B20: 37, B20: 39
CB-101...	B20: 16, B20: 17
CB101M...	B20: 10, B20: 11, B20: 17
CB1250...	B20: 10, B20: 11, B20: 12, B20: 13, B20: 24, B20: 27, B20: 29, B20: 37, B20: 39
CB-1500...	B20: 16, B20: 17, B20: 68
CB1500...	B20: 10, B20: 11, B20: 12, B20: 13, B20: 14, B20: 16, B20: 17, B20: 23, B20: 24, B20: 42, B20: 45
CB2000...	B20: 10, B20: 11, B20: 12, B20: 13, B20: 16, B20: 17, B20: 19, B20: 24, B20: 42, B20: 45, B20: 70
CB-202...	B20: 16, B20: 17, B20: 70, B20: 72, B20: 73
CB-203...	B20: 16, B20: 17, B20: 72, B20: 73
CB-204...	B20: 16, B20: 17
CB-206...	B20: 16, B20: 17
CB-2375...	B20: 16, B20: 17
CB-2500...	B20: 16, B20: 17, B20: 68
CB2500...	B20: 42
CB-3000...	B20: 16, B20: 17, B20: 69
CB3000...	B20: 10, B20: 11, B20: 12, B20: 13, B20: 16, B20: 17, B20: 19, B20: 24, B20: 42, B20: 45
CB4000...	B20: 10, B20: 11, B20: 16, B20: 17, B20: 19
CB6000...	B20: 17, B20: 42
CBER16...	B20: 26, B20: 27, B20: 28, B20: 29
CBER20...	B20: 26, B20: 27, B20: 28, B20: 29
CBER25...	B20: 26, B20: 27, B20: 28, B20: 29
CBER32...	B20: 26, B20: 27, B20: 28, B20: 29
CBER40...	B20: 26, B20: 27, B20: 28, B20: 29

Part No.	Page
CBR...	B20: 36, B20: 37
CBS...	B20: 38, B20: 39
CBT-0035...	B20: 50
CBT-0040...	B20: 50
CBT-0050...	B20: 48, B20: 50, B20: 51
CBT-0060...	B20: 48, B20: 50, B20: 51, B20: 68
CBT-0070...	B20: 50
CBT-0080...	B20: 48, B20: 50, B20: 51, B20: 68
CBT-0090...	B20: 50
CBT-0100...	B20: 48, B20: 50, B20: 51, B20: 68
CBT-0110...	B20: 48, B20: 51, B20: 68
CBT-0120...	B20: 49, B20: 50, B20: 69
CBT-0140...	B20: 49, B20: 69
CBT-0160...	B20: 49, B20: 69
CBT-0180...	B20: 49, B20: 69
CBT-0200...	B20: 49
CCET...	B20: 62
CCGT...	B20: 62, X: 22
CCGW...	B20: 62
CCMT...	B20: 63, X: 22
CCMW...	B20: 62
CDCD...	B20: 61
CFX...	B20: 56, B20: 57, B20: 58
CHB...	B20: 16, B20: 59, B20: 72, B20: 73
CHD...	B20: 50, B20: 51
CIL.25...	C: 59
CIL.32...	C: 59
CIL.40...	C: 59
CPMT...	B20: 61
CSL...	B20: 18, B20: 19
CT025M...	B20: 8, B20: 9
CT032M...	B20: 8, B20: 9
CT038M...	B20: 8, B20: 9
CT050M...	B20: 8, B20: 9
CT076M...	B20: 8, B20: 9
CT1000...	B20: 8, B20: 9
CT1250...	B20: 8, B20: 9
CT1500...	B20: 8, B20: 9
CT2000...	B20: 8, B20: 9
CT3000...	B20: 8, B20: 9
CTP038...	B20: 30, B20: 32, B20: 33, B20: 34, B20: 35
CTP038M...	B20: 31
CTP050...	B20: 30, B20: 32, B20: 33, B20: 34, B20: 35
CTP050M...	B20: 31
CTP076...	B20: 30, B20: 32, B20: 33, B20: 34, B20: 35
CTP076M...	B20: 31
CTP1500...	B20: 30, B20: 31, B20: 32, B20: 33, B20: 34, B20: 35

Part No.	Page
CTP2000...	B20: 30, B20: 31, B20: 32, B20: 33, B20: 34, B20: 35, B20: 71
CTP3000...	B20: 30, B20: 31, B20: 32, B20: 33, B20: 34, B20: 35
D	
DCGT...	X: 22
DCMT...	X: 22
G	
G1731...	A92: 16, A92: 17, A92: 28
H	
HSKA.100...	C: 58
HSKA.63...	C: 58
HXT0311S...	A20: 13
HXT0312S...	A20: 17
HXT0313S...	A20: 21
HXT0314S...	A20: 25
HXT0315S...	A20: 29
HXT0316S...	A20: 33
HXT0317S...	A20: 37
HXT0318S...	A20: 41
HXT0320S...	A20: 45
HXT0322S...	A20: 49
HXT0324S...	A20: 53
HXT0326S...	A20: 57
HXT0329S...	A20: 61
HXT0332S...	A20: 65
HXT0511S...	A20: 13
HXT0512S...	A20: 17
HXT0513S...	A20: 21
HXT0514S...	A20: 25
HXT0515S...	A20: 29
HXT0516S...	A20: 33
HXT0517S...	A20: 37
HXT0518S...	A20: 41
HXT0520S...	A20: 45
HXT0522S...	A20: 49
HXT0524S...	A20: 53
HXT0526S...	A20: 57
HXT0529S...	A20: 61
HXT0532S...	A20: 65
HXT0711S...	A20: 13
HXT0712S...	A20: 17
HXT0713S...	A20: 21
HXT0714S...	A20: 25
HXT0715S...	A20: 29
HXT0716S...	A20: 33
HXT0717S...	A20: 37
HXT0718S...	A20: 41
HXT0720S...	A20: 45
HXT0722S...	A20: 49
HXT0724S...	A20: 53
HXT0726S...	A20: 57
HXT0729S...	A20: 61
HXT0732S...	A20: 65
HXT1011S...	A20: 13
HXT1012S...	A20: 17
HXT1013S...	A20: 21
HXT1014S...	A20: 25
HXT1015S...	A20: 29

Part No.	Page
HXT1016S...	A20: 33
HXT1017S...	A20: 37
HXT1018S...	A20: 41
HXT1020S...	A20: 45
HXT1022S...	A20: 49
HXT1024S...	A20: 53
HXT1026S...	A20: 57
HXT1029S...	A20: 61
HXT1032S...	A20: 65
I	
I6149...	A92: 12, A92: 13, A92: 22, A92: 23, A92: 24, A92: 25
J	
J1926...	A92: 6, A92: 7, A92: 8, A92: 9, A92: 18, A92: 19, A92: 20, A92: 21
K	
KIT-050...	B20: 70
KIT-1500...	B20: 68
KIT-202...	B20: 70, B20: 72, B20: 73
KIT-203...	B20: 72, B20: 73
KIT-2500...	B20: 68
KIT-3000...	B20: 69
KIT-CB038...	B20: 72, B20: 73
KIT-CB050...	B20: 72, B20: 73
KIT-CB076...	B20: 72, B20: 73
KIT-CTP...	B20: 71
L	
LCB1500...	B20: 14, B20: 15
M	
MB002...	B20: 22, B20: 23
MB152...	B20: 22, B20: 23
MD0625...	B20: 41
MD0750...	B20: 41
MD1000...	B20: 41
MD1250...	B20: 41
MD16...	B20: 41
MD20...	B20: 41
MD25...	B20: 41
MD32...	B20: 41
MDB...	B20: 40, B20: 41
MT2...	B20: 44
MT3...	B20: 44
MT4...	B20: 44
MT5...	B20: 44
N	
NMBT...	B20: 44, B20: 70
O	
OP-05T308...	A50: 6, A60: 7, A60: 9, A60: 11, A60: 13, A60: 14, A60: 15, A60: 16, A60: 17, A60: 18, A60: 19, A60: 20, A70: 5, A70: 6, A70: 7, A70: 8, A70: 9, A70: 10, A70: 11, A70: 12, A70: 13
OP-060408...	A50: 6, A50: 8,

Part No.	Page
	A50: 10, A50: 18
OP-080508...	A50: 10, A50: 12, A50: 20, A50: 22
OP-090608...	A50: 12, A50: 14, A50: 16, A50: 24, A50: 26
OP1...	A70: 5, A70: 6, A70: 7, A70: 8, A70: 9, A70: 10, A70: 11, A70: 12, A70: 13
OP2...	A70: 5, A70: 6, A70: 7, A70: 8, A70: 9, A70: 10, A70: 11, A70: 12, A70: 13
OP3...	A70: 5, A70: 6, A70: 7, A70: 8, A70: 9, A70: 10, A70: 11, A70: 12, A70: 13
OP4...	A70: 5, A70: 6, A70: 7, A70: 8, A70: 9, A70: 10, A70: 11, A70: 12, A70: 13
R	
R34X22...	A60: 6, A60: 7
R34X35...	A60: 6, A60: 7
R34X45...	A60: 6, A60: 7
R36X22...	A60: 8, A60: 9
R36X35...	A60: 8, A60: 9
R36X45...	A60: 8, A60: 9
R38X22...	A60: 10, A60: 11
R38X35...	A60: 10, A60: 11
R38X45...	A60: 10, A60: 11
R42X22...	A60: 12, A60: 13
R42X35...	A60: 12, A60: 13
R42X45...	A60: 12, A60: 13
R44X22...	A60: 14
R44X35...	A60: 14
R46X22...	A60: 15
R46X35...	A60: 15
R48X10...	A60: 16
R48X25...	A60: 16
R52X10...	A60: 17
R52X25...	A60: 17
R54X10...	A60: 18
R54X25...	A60: 18
R56X10...	A60: 19
R56X25...	A60: 19
R58X10...	A60: 20
R58X25...	A60: 20
R8...	B20: 46, B20: 70, B20: 72
RDKF...	D: 18
RDKH...	D: 7, D: 8, D: 9
RDKI...	D: 12
RDKK...	D: 14
RDKL...	D: 16
RDKM...	D: 20
RDKN...	D: 22
RDKO...	D: 24

Part No.	Page
RDKP...	D: 26
RDKQ...	D: 28
RDKR...	D: 30
RDKS...	D: 32
RDKT...	D: 34
RDKU...	D: 36
RDRY...	D: 38
RSKF...	D: 19
RSKH...	D: 10, D: 11
RSKI...	D: 13
RSKK...	D: 15
RSKL...	D: 17
RSKM...	D: 21
RSKN...	D: 23
RSKO...	D: 25
RSKP...	D: 27
RSKQ...	D: 29
RSKR...	D: 31
RSKS...	D: 33
RSKT...	D: 35
RSKU...	D: 37
RSRY...	D: 39
S	
S1500...	B20: 19
S2000...	B20: 19
S3000...	B20: 19
SBT-0062...	B20: 52, B20: 53
SBT-0093...	B20: 52, B20: 53
SBT-0125...	B20: 52, B20: 53, B20: 72, B20: 74, B20: 75, B20: 76
SBT-0187...	B20: 52, B20: 53, B20: 72, B20: 74, B20: 75, B20: 76
SBT-0250...	B20: 52, B20: 53, B20: 72, B20: 74, B20: 75, B20: 76
SBT-03...	B20: 53, B20: 72, B20: 76
SBT-0312...	B20: 52, B20: 53, B20: 72, B20: 74, B20: 75, B20: 76
SBT-0375...	B20: 52, B20: 53, B20: 72, B20: 74, B20: 75, B20: 76
SBT-04...	B20: 53, B20: 72, B20: 76
SBT-0500...	B20: 52, B20: 53, B20: 72, B20: 74, B20: 75, B20: 76
SBT-06...	B20: 53, B20: 72, B20: 76
SBT-0625...	B20: 52, B20: 72, B20: 74
SBT-0750...	B20: 52, B20: 72, B20: 74, B20: 75
SBT-08...	B20: 53, B20: 72, B20: 76
SBT-10...	B20: 53, B20: 72, B20: 76
SBT-1000...	B20: 52, B20: 72, B20: 74, B20: 75
SBT-12...	B20: 53, B20: 72,

Part No.	Page
	B20: 76
SBT-1250...	B20: 52, B20: 72, B20: 74
SBT-16...	B20: 53, B20: 72, B20: 76
SBT-19...	B20: 53, B20: 72, B20: 76
SBT-25...	B20: 53, B20: 72, B20: 76
SBT-32...	B20: 53, B20: 72, B20: 76
SCMT...	X: 23
SET-SB...	B20: 74, B20: 75, B20: 76
SET-TA...	B20: 77
SGL...	B20: 29, B20: 37
SL202...	B20: 19
SL203...	B20: 19
SL204...	B20: 19
SP34X22...	A60: 6, A60: 7
SP36X22...	A60: 8, A60: 9
SP38X22...	A60: 10, A60: 11
SP42X22...	A60: 12, A60: 13
SP44X22...	A60: 14
SP46X22...	A60: 15
SP48X10...	A60: 16
SP48X25...	A60: 16
SP52X10...	A60: 17
SP52X25...	A60: 17
SP54X10...	A60: 18
SP54X25...	A60: 18
SP56X10...	A60: 19
SP56X25...	A60: 19
SP58X10...	A60: 20
SP58X25...	A60: 20
SQ-1500...	B20: 18, B20: 19
SQ-2000...	B20: 18, B20: 19
SQ-3000...	B20: 18, B20: 19
SS0500...	B20: 46
SS0625...	B20: 46
SS0750...	B20: 46
SS1000...	B20: 46
SS1250...	B20: 46
SS1500...	B20: 46
SS2000...	B20: 46
ST03120...	A91: 8
ST03140...	A91: 9
ST03150...	A91: 10
ST03160...	A91: 11
ST03170...	A91: 12
ST03180...	A91: 13
ST03200...	A91: 14
ST03220...	A91: 15
ST03225...	A91: 15
ST03240...	A91: 16
ST03260...	A91: 17
ST03290...	A91: 18
ST03320...	A91: 19
ST05120...	A91: 8
ST05140...	A91: 9
ST05150...	A91: 10
ST05160...	A91: 11
ST05170...	A91: 12

Part No.	Page
ST05180...	A91: 13
ST05200...	A91: 14
ST05220...	A91: 15
ST05225...	A91: 15
ST05240...	A91: 16
ST05260...	A91: 17
ST05290...	A91: 18
ST05320...	A91: 19
ST07120...	A91: 8
ST07140...	A91: 9
ST07150...	A91: 10
ST07160...	A91: 11
ST07170...	A91: 12
ST07180...	A91: 13
ST07200...	A91: 14
ST07220...	A91: 15
ST07225...	A91: 15
ST07240...	A91: 16
ST07260...	A91: 17
ST07290...	A91: 18
ST07320...	A91: 19
T	
TA-0250...	B20: 54, B20: 68, B20: 69, B20: 70, B20: 71, B20: 73, B20: 77
TA-0312...	B20: 54, B20: 68, B20: 69, B20: 70, B20: 71, B20: 73, B20: 77
TA-0375...	B20: 54, B20: 68, B20: 69, B20: 70, B20: 71, B20: 73, B20: 77
TA-0437...	B20: 54, B20: 68, B20: 69, B20: 70, B20: 71, B20: 73, B20: 77
TA-0500...	B20: 54, B20: 68, B20: 69, B20: 70, B20: 71, B20: 73, B20: 77
TA-06...	B20: 55, B20: 70, B20: 73, B20: 77
TA-0625...	B20: 54
TA-0750...	B20: 69, B20: 73, B20: 77
TA-08...	B20: 55, B20: 70, B20: 73, B20: 77
TA-10...	B20: 55, B20: 70, B20: 73, B20: 77
TA-1000...	B20: 54, B20: 69, B20: 73, B20: 77
TA-12...	B20: 55, B20: 70, B20: 73, B20: 77
TA-1250...	B20: 54, B20: 69, B20: 73, B20: 77
TA-16...	B20: 55, B20: 77
TA-20...	B20: 55, B20: 73, B20: 77
TA-25...	B20: 55, B20: 77
T-ACR-45...	A30: 43, A30: 57, A30: 73, A30: 111

Part No.	Page
TAS-06...	B20: 55, B20: 73, B20: 77
TAS-08...	B20: 55, B20: 73, B20: 77
TAS-10...	B20: 55, B20: 73, B20: 77
TAS-12...	B20: 55, B20: 73
TAS-16...	B20: 55, B20: 73
TAS-20...	B20: 55, B20: 73
TAS-25...	B20: 55
TCGT...	X: 23
TCMT...	A20: 15, A20: 19, A20: 23, A20: 27, A20: 31, A20: 35, A20: 39, A20: 43, A20: 47, A20: 51, A20: 55, A20: 59, A20: 63, A20: 67, B20: 64, B20: 68, B20: 69, X: 23
TFX...	B20: 56, B20: 57, B20: 58
THN...	E: 35
THP...	E: 42
THT...	E: 35
TM...	E: 16, E: 17, E: 18, E: 19, E: 20, E: 21, E: 22, E: 23, E: 24, E: 25, E: 26, E: 27
TMAK...	A92: 18, A92: 20, A92: 26
TMAU...	A92: 19, A92: 21, A92: 27
TMBK...	E: 6
TMBKxBSPP...	E: 9
TMBKxBSPT...	E: 8
TMxBSP...	E: 9
TMxBSP...	E: 8
TMxBSW...	E: 6, E: 7
TMMK...	A92: 22, A92: 24, A92: 28, E: 24, E: 26
TMMU...	A92: 23, A92: 25
TMNKxNPT...	E: 10
TMNKxNPTF...	E: 12
TMxNPS...	E: 14
TMxNPSF...	E: 15
TMxNPT...	E: 10, E: 11
TMxNPTF...	E: 12, E: 13
TMT-0750...	B20: 22, B20: 23
TMT0750...	B20: 23
TMT-1000...	B20: 22, B20: 23
TMT1000...	B20: 23
TMUK...	E: 16, E: 17, E: 18, E: 19
TN100K-FA...	E: 37
TN100K-UN...	E: 38, E: 39
TN100K-UNJ...	E: 40
TN150K-AP...	E: 37
TN150K-BSPP...	E: 37
TN150K-BSPT...	E: 36

Part No.	Page
TN150K-FA...	E: 37
TN150K-M...	E: 41
TN150K-NPT...	E: 36
TN150K-NPTF...	E: 36
TN150K-UN...	E: 38, E: 39
TN150K-UNJ...	E: 40
TNR...	E: 42
TP075K-BSPP...	E: 31
TP075K-BSPT...	E: 31
TP075K-M...	E: 34
TP075K-NPT...	E: 30
TP075K-NPTF...	E: 30
TP075K-UN...	E: 32
TP075K-UNJ...	E: 33
TP100K-BSPP...	E: 31
TP100K-BSPT...	E: 31
TP100K-M...	E: 34
TP100K-NPT...	E: 30
TP100K-NPTF...	E: 30
TP100K-UN...	E: 32
TP100K-UNJ...	E: 33
TPGT...	B20: 65, B20: 68, B20: 69
TPGW...	B20: 66
TPMT...	B20: 65
TSN...	E: 43
TSR...	E: 43
V	
V3300D...	A50: 6
V3301D...	A50: 6
V3316D...	A50: 6
V3318D...	A50: 6
V3320D...	A50: 6
V3800D...	A50: 8
V3801D...	A50: 8
V3815D...	A50: 8
V3817D...	A50: 8
V3818D...	A50: 8
V3820D...	A50: 8
V4401D...	A50: 10
V4417D...	A50: 10
V4418D...	A50: 10
V4422D...	A50: 10
V5101D...	A50: 12
V5118D...	A50: 12
V5120D...	A50: 12
V5122D...	A50: 12
V5701D...	A50: 14
V5702D...	A50: 14
V5722D...	A50: 14
V5724D...	A50: 14
V5726D...	A50: 14
V6302D...	A50: 16
V6326D...	A50: 16
V6329D...	A50: 16
V6332D...	A50: 16

Part No.	Page
V7002S...	A50: 18
V7029S...	A50: 18
V7602S...	A50: 20
V7629S...	A50: 20
V8302S...	A50: 22
V8332S...	A50: 22
V8902S...	A50: 24
V8929S...	A50: 24
V9502S...	A50: 26
V9532S...	A50: 26
W	
W3303H...	A50: 7
W3803H...	A50: 7
W3805H...	A50: 7
W3808H...	A50: 7
W3810H...	A50: 7
W4403H...	A50: 9, A50: 11
W4405H...	A50: 9, A50: 11
W4408H...	A50: 9, A50: 11
W4410H...	A50: 9, A50: 11
W5103H...	A50: 13
W5105H...	A50: 13
W5108H...	A50: 13
W5110H...	A50: 13
W5703H...	A50: 15
W5705H...	A50: 15
W5708H...	A50: 15
W5710H...	A50: 15
W6303H...	A50: 17
W6305H...	A50: 17
W6308H...	A50: 17
W6310H...	A50: 17
W7003H...	A50: 19
W7005H...	A50: 19
W7008H...	A50: 19
W7010H...	A50: 19
W7603H...	A50: 21
W7605H...	A50: 21
W7608H...	A50: 21
W8303H...	A50: 23
W8305H...	A50: 23
W8308H...	A50: 23
W8903H...	A50: 25
W8905H...	A50: 25
W8908H...	A50: 25
W9503H...	A50: 27
W9505H...	A50: 27
W9508H...	A50: 27
WCMT...	B20: 67, B20: 68, B20: 69
WP..	A50: 18, A50: 20, A50: 22, A50: 24, A50: 26
X	
X1926...	A92: 10, A92: 11
XTK11...	A20: 12
XTK12...	A20: 16
XTK13...	A20: 20
XTK14...	A20: 24
XTK15...	A20: 28
XTK16...	A20: 32
XTK17...	A20: 36
XTK18...	A20: 40

Part No.	Page
XTK20...	A20: 44
XTK22...	A20: 48
XTK24...	A20: 52
XTK26...	A20: 56
XTK29...	A20: 60
XTK32...	A20: 64
XTN11...	A20: 12
XTN12...	A20: 16
XTN13...	A20: 20
XTN14...	A20: 24
XTN15...	A20: 28
XTN16...	A20: 32
XTN17...	A20: 36
XTN18...	A20: 40
XTN20...	A20: 44
XTN22...	A20: 48
XTN24...	A20: 52
XTN26...	A20: 56
XTN29...	A20: 60
XTN32...	A20: 64
XTP11...	A20: 12
XTP12...	A20: 16
XTP13...	A20: 20
XTP14...	A20: 24
XTP15...	A20: 28
XTP16...	A20: 32
XTP17...	A20: 36
XTP18...	A20: 40
XTP20...	A20: 44
XTP22...	A20: 48
XTP24...	A20: 52
XTP26...	A20: 56
XTP29...	A20: 60
XTP32...	A20: 64

Guaranteed Test / Demo Application Form

Distributor PO #	
------------------	--

The following must be filled out completely before your test will be considered

IMPORTANT: For processing, send Purchase Order to your Allied Field Sales Engineer (FSE). Please clearly mark the paperwork as "Test Order."

Distributor Information

Company Name: _____
 Contact: _____
 Account Number: _____
 Phone: _____
 Email: _____

End User Information

Company Name: _____
 Contact: _____
 Industry: _____
 Phone: _____
 Email: _____

Current Process List all tooling, coatings, substrates, speeds and feeds, tool life, and any problems you are experiencing

Test Objective List what would make this a successful test (i.e. penetration rate, finish, tool life, hole size, etc.)

Application Information

Hole Diameter: _____ in/mm	Tolerance: _____	Material: _____ (4150 / A36 / Cast Iron / etc.)
Pre-existing Diameter: _____ in/mm	Depth of Cut: _____ in/mm	Hardness: _____ (BHN / Rc)
Required Finish: _____ RMS	State: _____	(Casting / Hot rolled / Forging)

Machine Information

Machine Type: _____ (Lathe / Screw machine / Machine center / etc.)	Builder: _____ (Haas, Mori Seiki, etc.)	Model #: _____
Shank Required: _____ (CAT50 / Morse taper, etc.)		Power: _____ HP/KW
Rigidity: _____	Orientation: _____	Tool Rotating: _____
<input type="checkbox"/> Excellent	<input type="checkbox"/> Vertical	<input type="checkbox"/> Yes
<input type="checkbox"/> Good	<input type="checkbox"/> Horizontal	<input type="checkbox"/> No
<input type="checkbox"/> Poor		Thrust: _____ lbs/N

Coolant Information

Coolant Delivery: _____ (Through tool / Flood)	Coolant Pressure: _____ PSI / bar
Coolant Type: _____ (Air mist, oil, synthetic, water soluble, etc.)	Coolant Volume: _____ GPM / LPM

Requested Tooling

QTY	Item Number	QTY	Item Number



Allied Machine & Engineering
 120 Deeds Drive
 Dover, OH 44622
 Telephone: (330) 343-4283
 Toll Free USA & Canada: (800) 321-5537
 Fax: (330) 602-3400
 Email: info@alliedmachine.com



Warranty Information



Allied Machine & Engineering warrants to original equipment manufacturers, distributors, industrial and commercial users of its products that each new product manufactured or supplied by Allied Machine shall be free from defects in material and workmanship.

Allied Machine's obligation under this warranty is limited to furnishing without additional charge a replacement or, at its option repairing or issuing credit for any product which shall within one year from the date of sale be returned freight prepaid to the plant designated by an Allied Machine representative and which upon inspection is determined by Allied Machine to be defective in materials or workmanship.

Complete information as to operating conditions, machine, set-up, and application of cutting fluid should accompany any product returned for inspection. The provisions of this warranty shall not apply to any Allied Machine products which have been subjected to misuse, improper operating conditions, machine set-up or application of cutting fluid or which have been repaired or altered if such repair or alteration in the judgment of Allied Machine would adversely affect performance of the product.

THIS WARRANTY IS IN LIEU OF ALL OTHER WARRANTIES, EXPRESS OR IMPLIED, INCLUDING ANY IMPLIED WARRANTY OF MERCHANTABILITY OR FITNESS FOR A PARTICULAR PURPOSE. Allied Machine shall have no liability or responsibility on any claim of any kind, whether in contract, tort or otherwise, for any loss or damage arising out of, connected with, or resulting from the manufacture, sale, delivery or use of any product sold hereunder, in excess of the cost of replacement or repair as provided herein.

ALL PRICES, DELIVERIES, DESIGNS, AND MATERIALS ARE SUBJECT TO CHANGE WITHOUT NOTICE.



Allied Machine & Engineering
Registered to ISO 9001
10001329

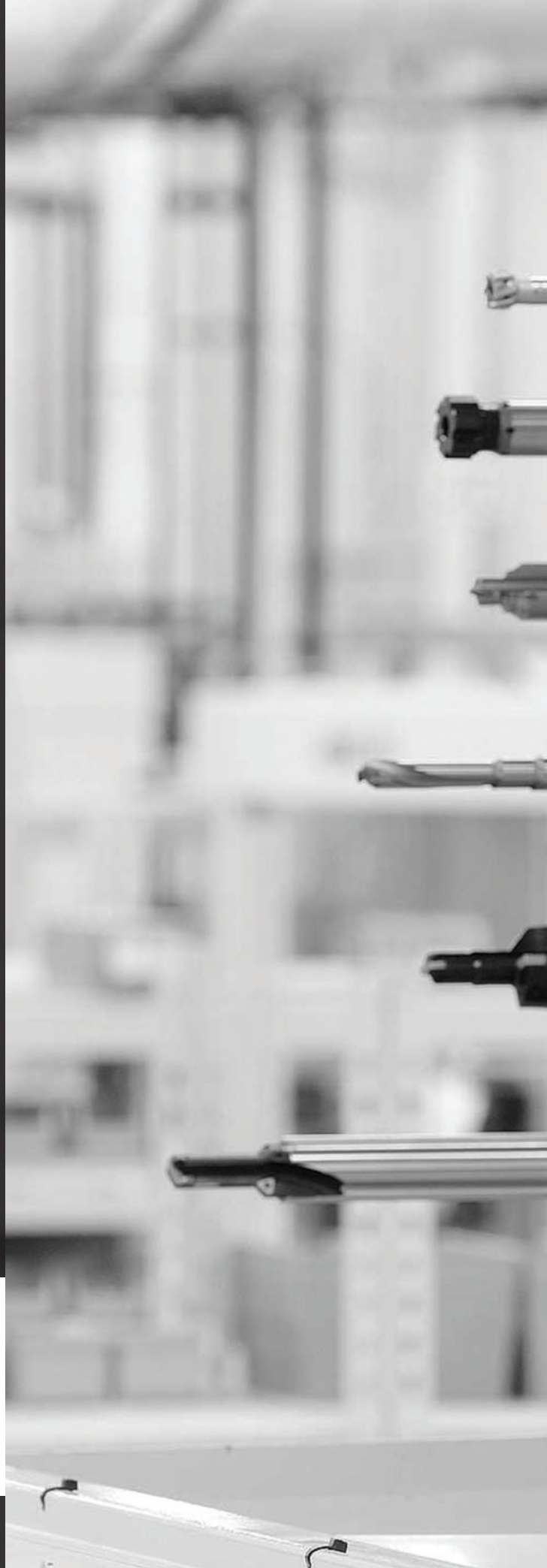

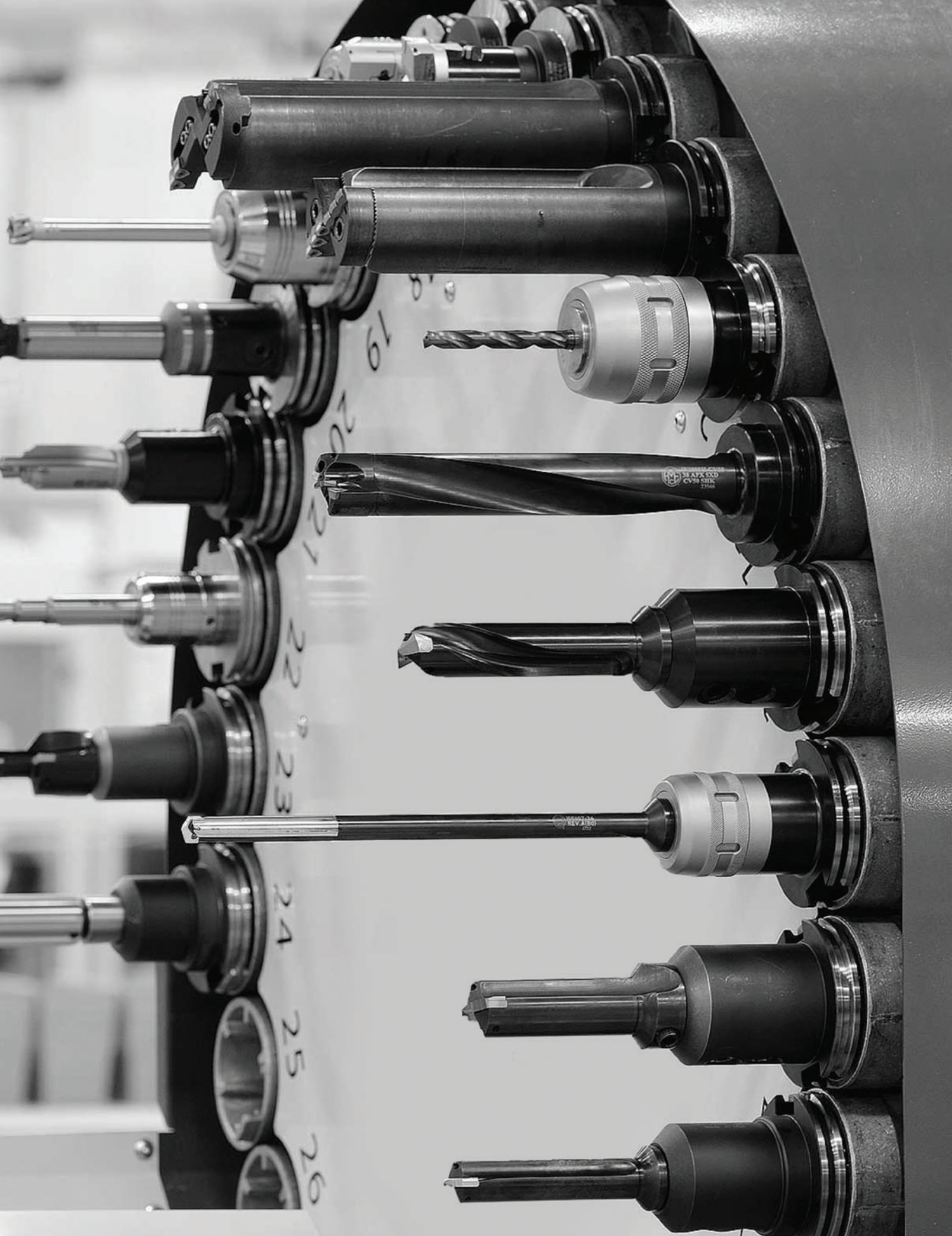

United States

Allied Machine & Engineering

120 Deeds Drive
Dover OH 44622
United States

Phone:

330.343.4283

Fax:

330.602.3400

Toll Free USA and Canada:

800.321.5537

Toll Free USA and Canada:

800.223.5140

Allied Machine & Engineering

485 W Third Street
Dover OH 44622
United States

Phone:

330.343.4283

Fax:

330.364.7666
(Engineering Dept.)

Toll Free USA and Canada:

800.321.5537

Europe

Allied Machine & Engineering Co. (Europe) Ltd.

93 Vantage Point
Pensnett Estate
Kingswinford
West Midlands
DY6 7FR England

Phone:

+44 (0) 1384 400900

Wohlhaupter GmbH

Maybachstrasse 4
Postfach 1264
72636 Frickenhausen
Germany

Phone:

011-49-7022-408-0

Fax:

011-49-7022-408-212

Asia

Wohlhaupter India Pvt. Ltd.

B-23, 2nd Floor
B Block Community Centre
Janakpuri, New Delhi - 110058
India

Phone:

+91-11-41827044

Your local Allied Machine representative: